

PLASTIC SURGERY INSTRUMENTS

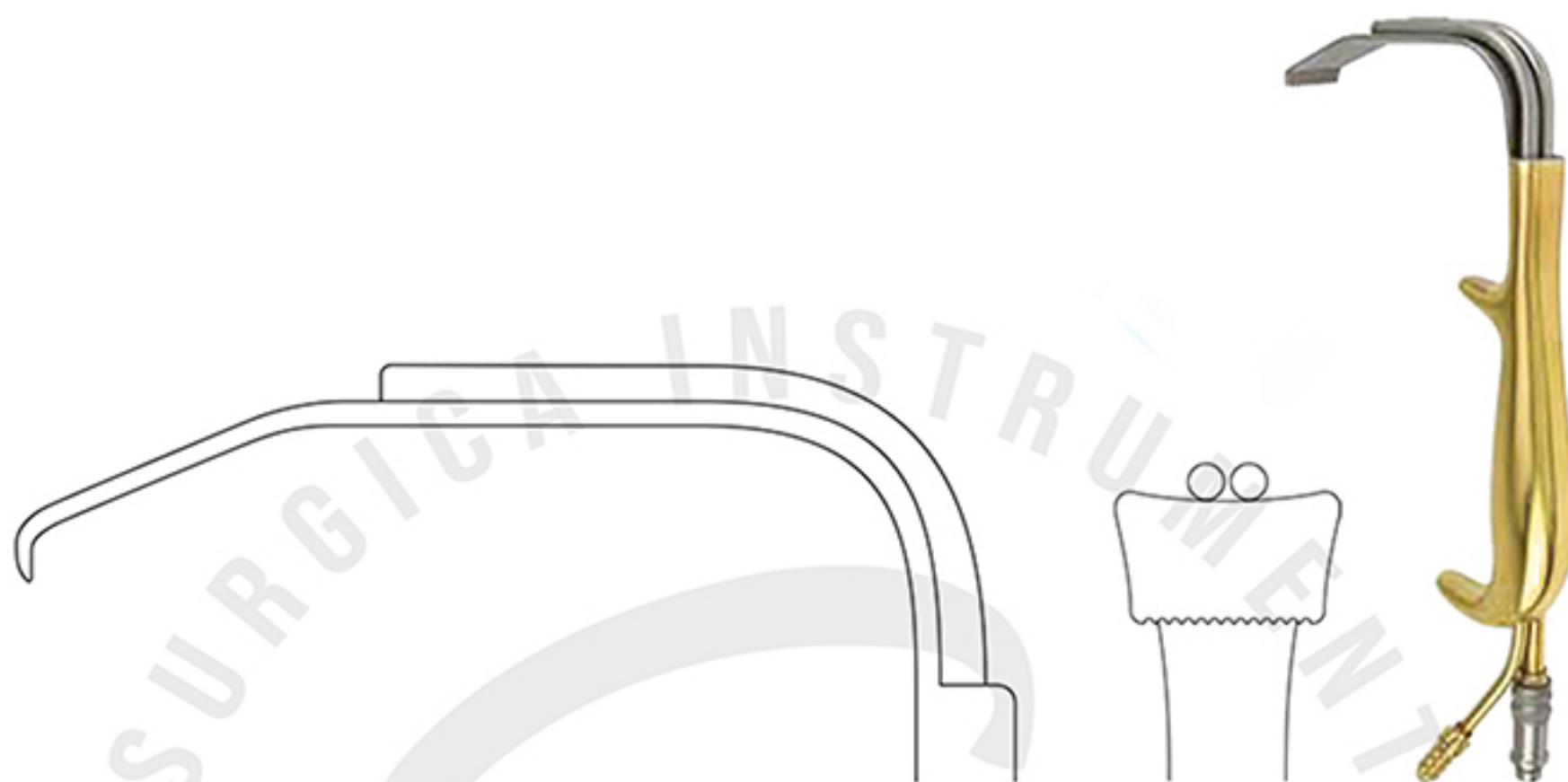

Rétracteurs à fibre optique
Fiber Optic Retractors
Faseroptische Retraktoren
Retradores de fibra óptica



TBTS-Style Fiber Optic Retractor
with Suction Port with Teeth
Blade Size 90 x 24 mm
SI-PSI-786-1

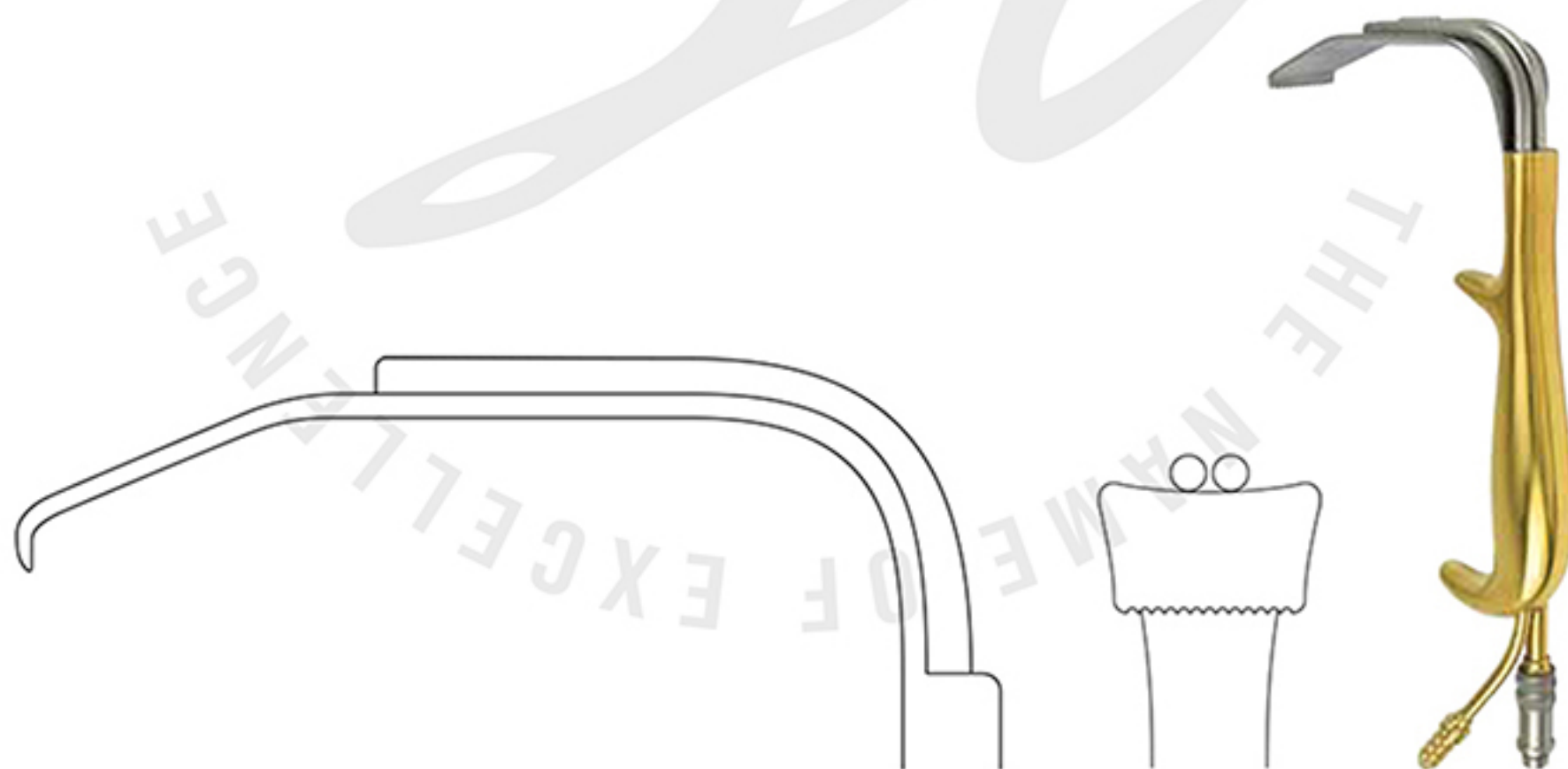

TBTS-Style Fiber Optic Retractor
with Suction Port with Teeth
Blade Size 90 x 30 mm
SI-PSI-786-2

Rétracteurs à fibre optique
Fiber Optic Retractors
Faseroptische Retraktoren
Retradores de fibra óptica

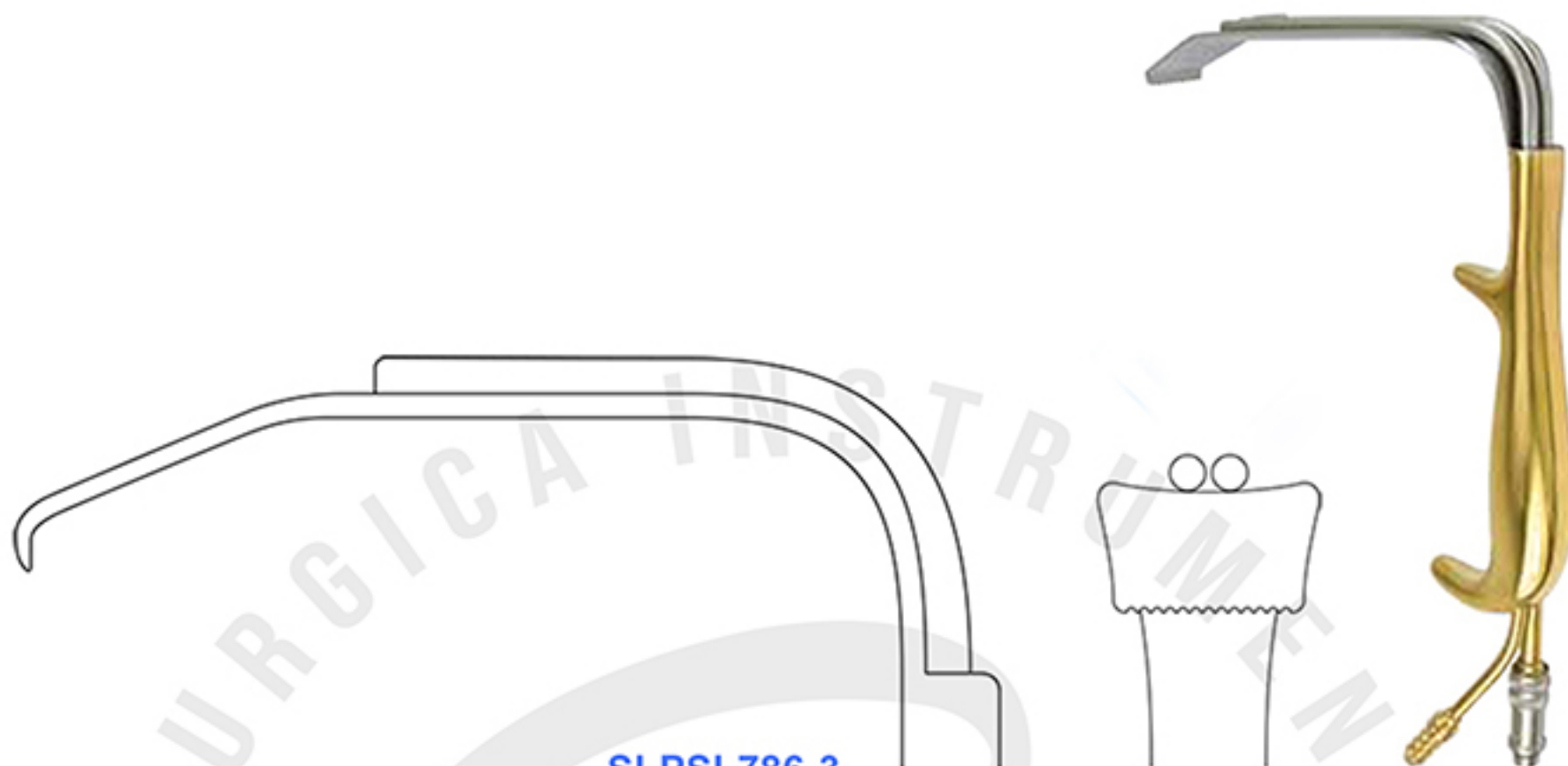

SI-PSI-786-3

TBTS-Style Fiber Optic Retractor
with Suction Port with Teeth
Blade Size 150 x 30 mm

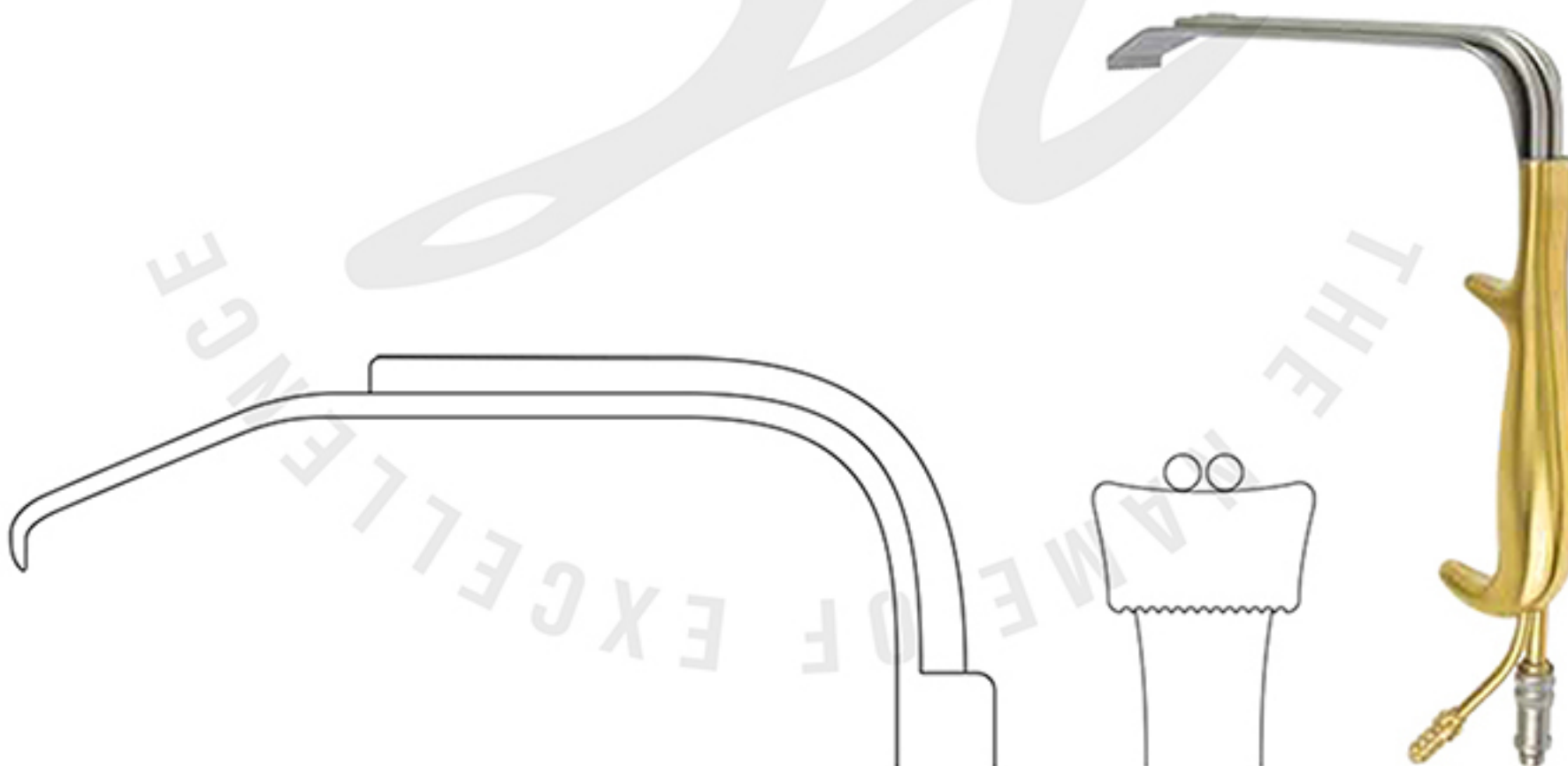

SI-PSI-786-4

TBTS-Style Fiber Optic Retractor
with Suction Port with Teeth
Blade Size 190 x 30 mm

Rétracteurs à fibre optique
Fiber Optic Retractors
Faseroptische Retraktoren
Retradores de fibra óptica

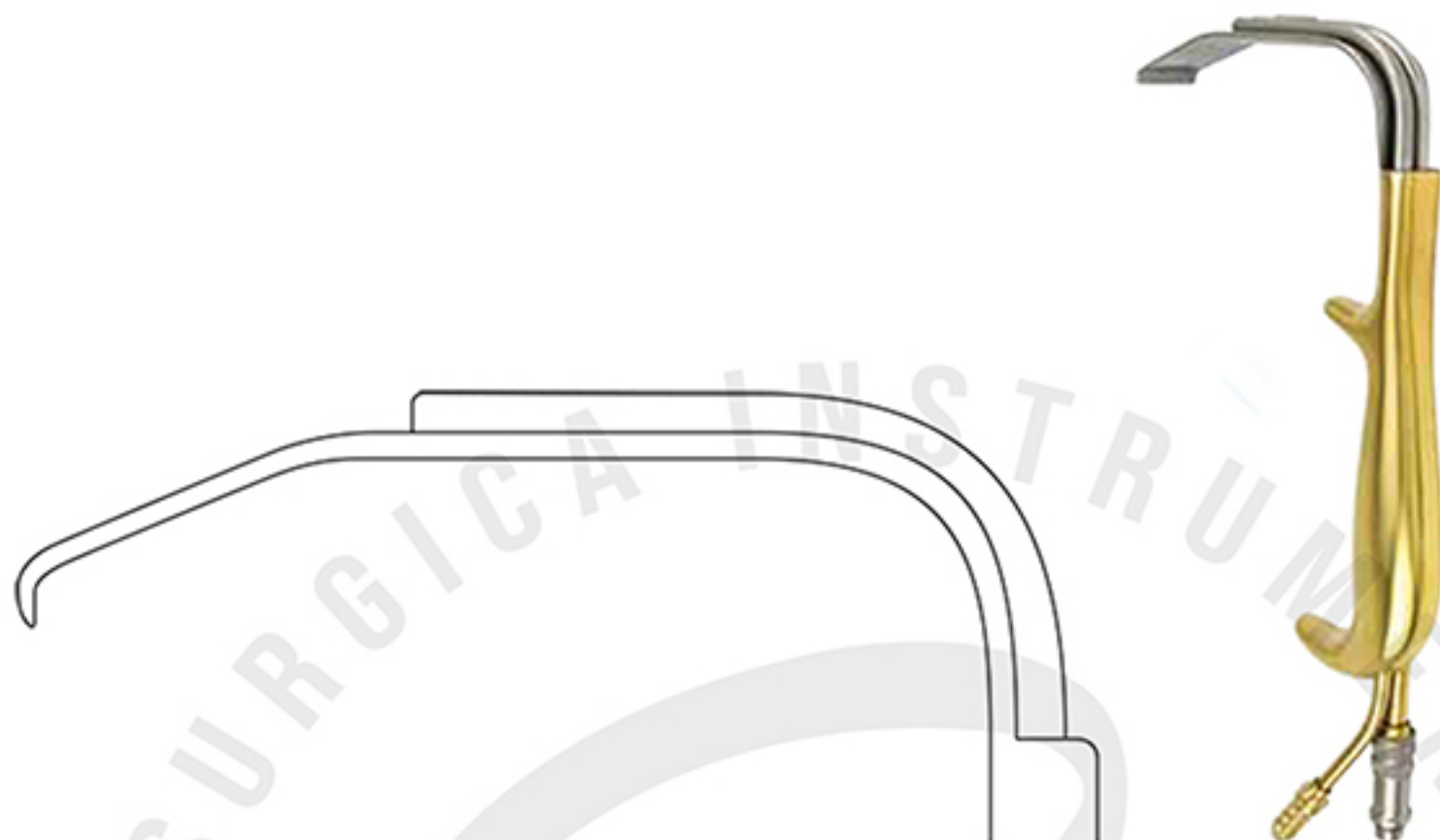

TBTS-Style Fiber Optic Retractor
with Suction Port without Teeth
Blade Size 90 x 24 mm
SI-PSI-786-5

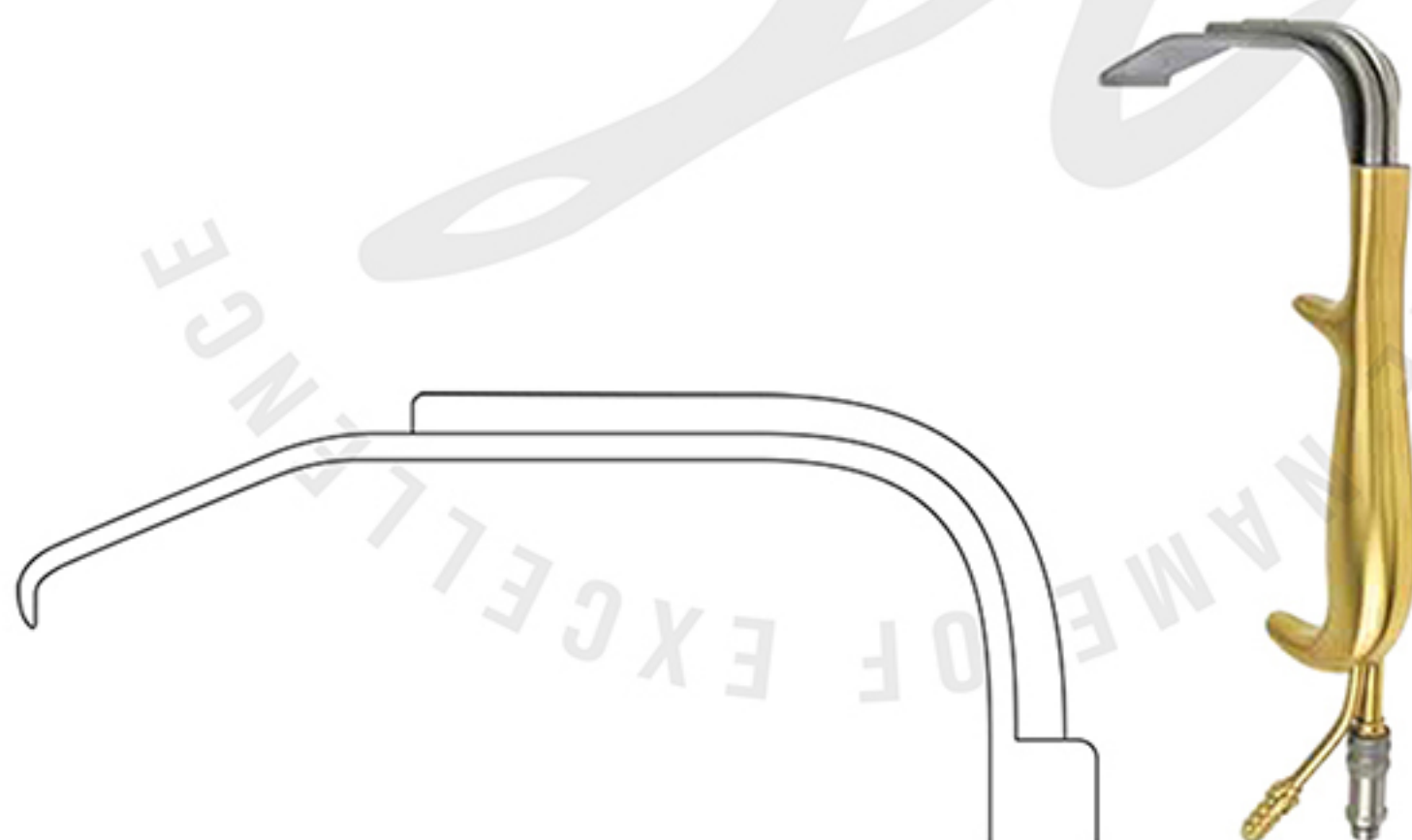

TBTS-Style Fiber Optic Retractor
with Suction Port without Teeth
Blade Size 90 x 30 mm
SI-PSI-786-6

Rétracteurs à fibre optique
Fiber Optic Retractors
Faseroptische Retraktoren
Retradores de fibra óptica

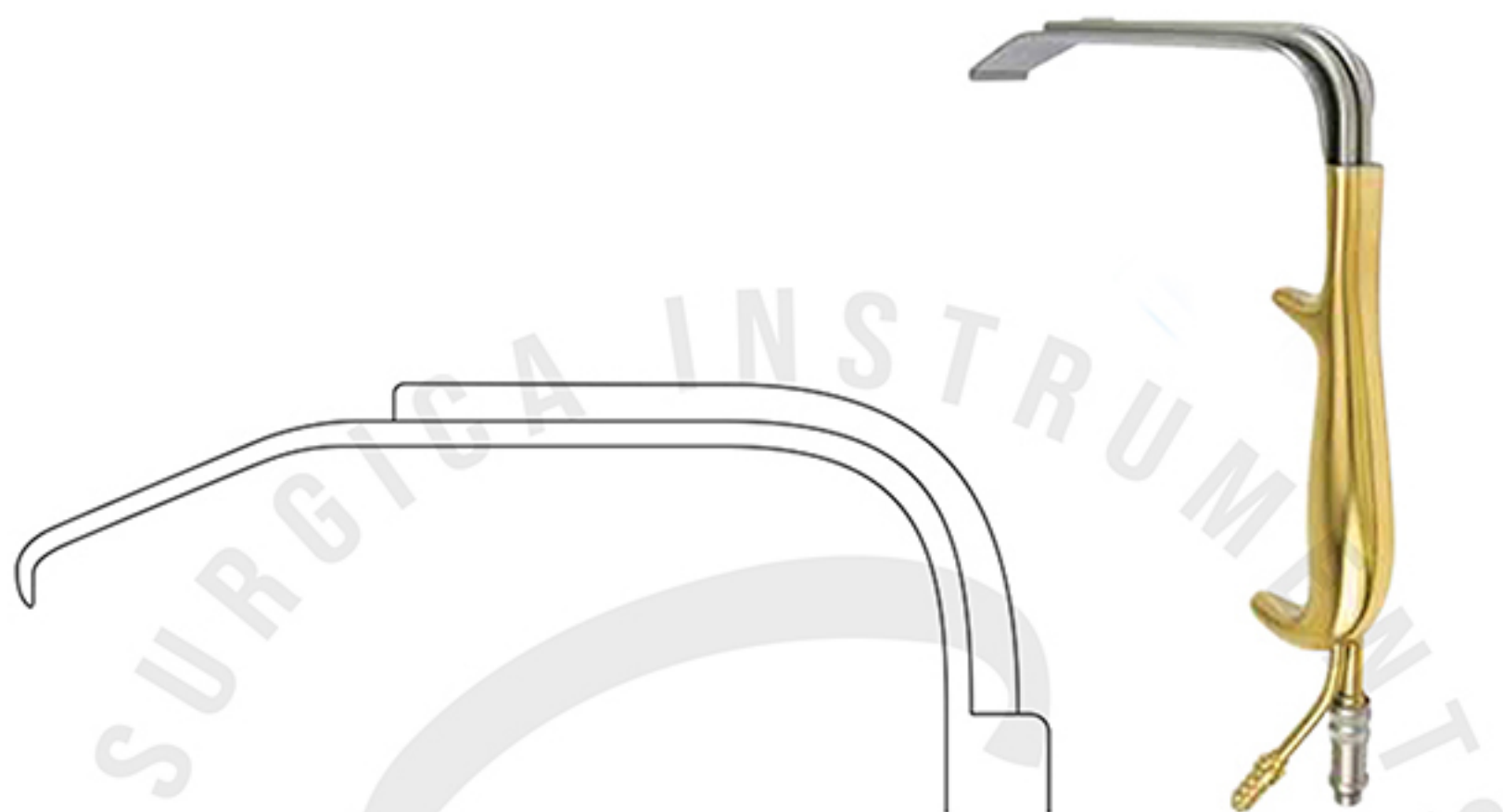

TBTS-Style Fiber Optic Retractor
with Suction Port without Teeth
Blade Size 150 x 30 mm
SI-PSI-786-7

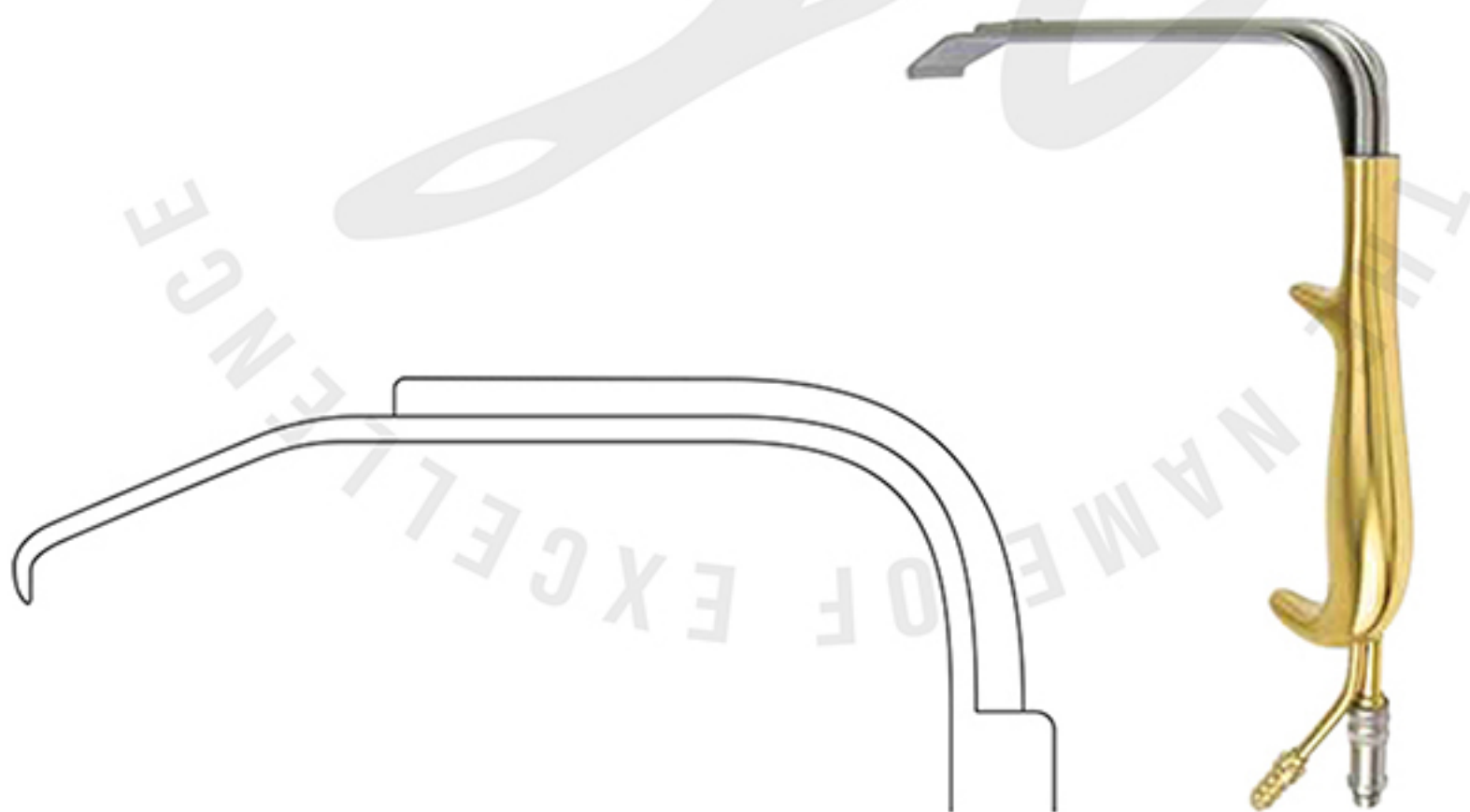

TBTS-Style Fiber Optic Retractor
with Suction Port without Teeth
Blade Size 190 x 30 mm
SI-PSI-786-8

Rétracteurs à fibre optique
Fiber Optic Retractors
Faseroptische Retraktoren
Retradores de fibra óptica

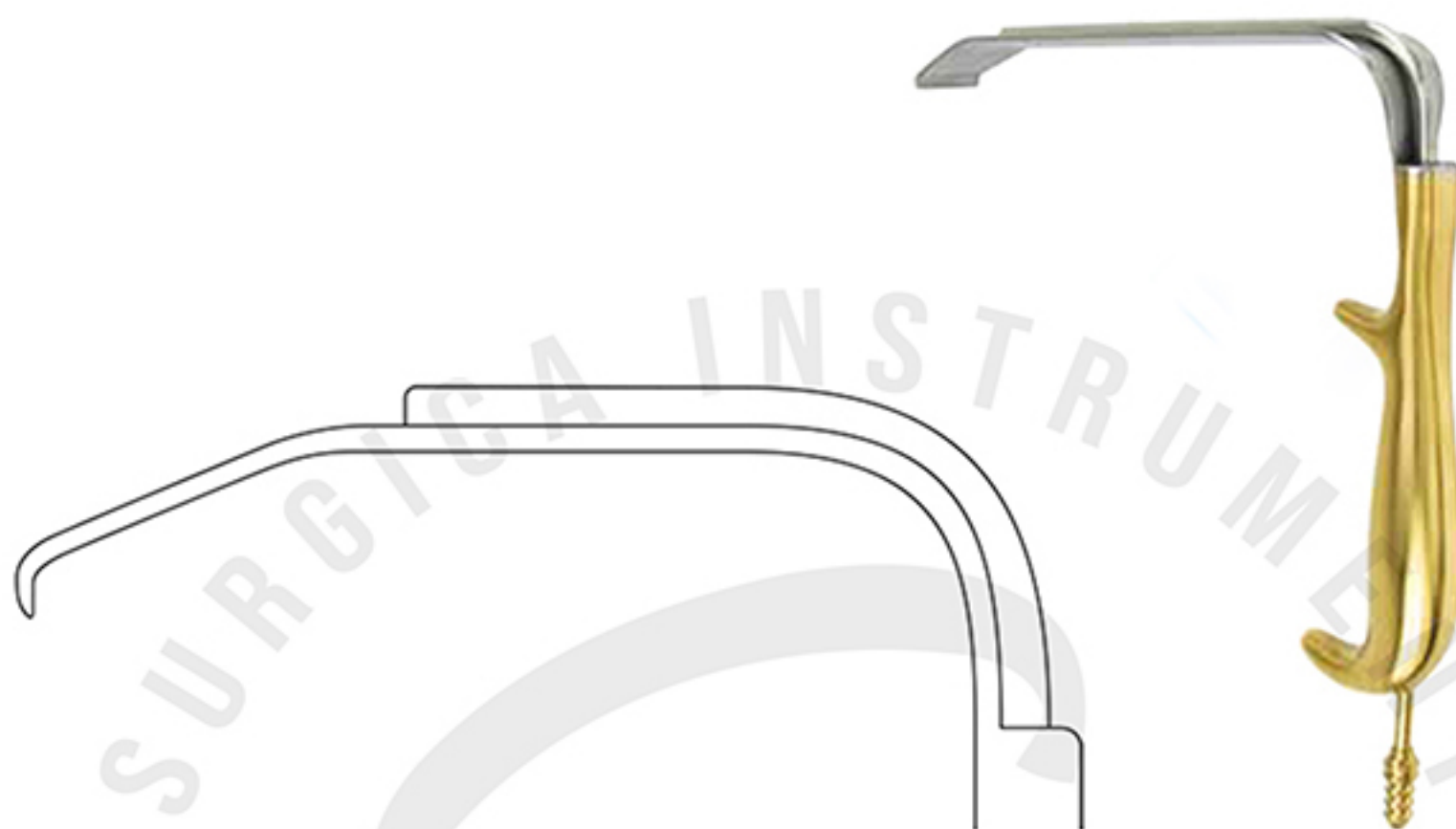

TBTS-Style Endoplastic Retractor
with Suction Port
Blade Size 190 mm
SI-PSI-786-9



Biggs Face Lift Retractor
Handle Length 9" - 22.9 cm
Blade Width 5.5 cm
SI-PSI-786-10



Biggs Mammoplasty Retractor, Standard
Handle Length 8" - 20.3 cm
Blade Width 5 cm
SI-PSI-786-11

Rétracteurs à fibre optique
Fiber Optic Retractors
Faseroptische Retraktoren
Retradores de fibra óptica



Biggs Mammoplasty Retractor, Narrow
Handle Length 8" - 20.3 cm
Blade Width 3 cm
SI-PSI-786-12



Ferreira Breast Augmentation Retractor
13 cm
Blade Width 25 mm x 171 mm
SI-PSI-786-13



Ferreira Face Lift Retractor
10.8 cm
Blade Width 22 mm x 108 mm
SI-PSI-786-14



Aufrecht Retractor Fixed Fiber Optic
20.3 cm
Handle Length 8" - 20.3 cm
Blade Width
7 mm **SI-PSI-786-15**
10 mm **SI-PSI-786-15A**

Rétracteurs à fibre optique
Fiber Optic Retractors
Faseroptische Retraktoren
Retradores de fibra óptica



Freeman Flap Retractor
20.3 cm
Blade Width 13 mm
SI-PSI-786-16



Deaver Retractor
16 mm
Blade Width 20.3 cm - 8"
SI-PSI-786-17



Deaver Retractor Fiber Optic
30.5 cm - 12"
Blade Width 25 mm
SI-PSI-786-18



Killian Nasal Speculum
With Fiber Optics Illumination
14 cm
Blade Width 51 mm
SI-PSI-786-19

Rétracteurs à fibre optique
Fiber Optic Retractors
Faseroptische Retraktoren
Retradores de fibra óptica



Biggs Mammoplasty Retractor
with Suction And Fiber Optic
Size
30 mm Narrow **SI-PSI-787-3001**
50mm Wide **SI-PSI-787-3001A**

Converse Nasal Retractor
with Fiber Optic

10 x 20 mm
Size
12 x 30 mm **SI-PSI-787-3002**
12 x 40 mm **SI-PSI-787-3002A**
12 x 50 mm **SI-PSI-787-3002B**



Wieder Tongue Depressor
with Fiber Optic

10 x 20 mm
Size
12 x 30 mm **SI-PSI-787-3003**
12 x 40 mm **SI-PSI-787-3003A**
12 x 50 mm **SI-PSI-787-3003B**



Bauer Intra Oral Retractor
For Right & Left Cheek
21 cm
SI-PSI-787-3004

Rétracteurs à fibre optique
Fiber Optic Retractors
Faseroptische Retraktoren
Retradores de fibra óptica



Petri Pterygoid Intra Oral Retractor
With Fiber Optic
23 cm
Working Tip 25.5 mm
SI-PSI-787-3005



Maliniac Nasal Retractor
10 cm 4"
Blade Size
9mm x 45mm
SI-PSI-787-3006



Levasseur Merrill Retractor
With Fiber Optic
25 cm
Working Tip 27 mm
SI-PSI-787-3007



Shea Multipurpose Retractor
With Fiber Optic
25 cm
Working Tip 14.5 mm
SI-PSI-787-3008

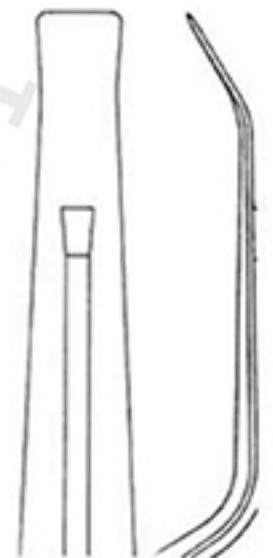

Rétracteurs à fibre optique
Fiber Optic Retractors
Faseroptische Retraktoren
Retradores de fibra óptica



Sigmoid Notch Extra Oral Retractor
With Fiber Optic
8 3/4" - 22 cm
SI-PSI-787-3009



Breast Retractor With Teeth
With Suction & Fiber Optic
27mm x 8cm
Width & Working Length:
27 mm x 9 cm **SI-PSI-787-3010**
27 mm x 10 cm **SI-PSI-787-3010A**
27 mm x 11.5 cm **SI-PSI-787-3010B**
27 mm x 12 cm **SI-PSI-787-3010C**
27 mm x 15 cm **SI-PSI-787-3010D**
27 mm x 16 cm **SI-PSI-787-3010E**
27 mm x 17 cm **SI-PSI-787-3010F**
27 mm x 19 cm **SI-PSI-787-3010G**



Aufricht Retractor
With Changeable Fiber Optic
Length & Blades
16cm x 7mm **SI-PSI-787-3011**
18cm x 10mm **SI-PSI-787-3011A**

Rétracteurs à fibre optique
Fiber Optic Retractors
Faseroptische Retraktoren
Retradores de fibra óptica



Walter Alar Retractor
With Fiber Optic
18.5 cm
[SI-PSI-787-3012](#)

Tebbets Style Retractor
With Teeth

24 mm x 9 cm

Width & Working Length:

30mm x 9cm [SI-PSI-787-3013](#)

30mm x 15cm [SI-PSI-787-3013A](#)

30mm x 19cm [SI-PSI-787-3013B](#)



Sculpo Mammoplasty Retractor
with Endoscopic Channel &
Stopcock to hold 10 mm telescopes
Width & Working Length
25mm x 18cm
[SI-PSI-787-3014](#)

Écarteur et dissecteurs
Retractor & Dissectors
Retraktor & Dissektoren
Retractor y disectores



TBTS-Style Double Ended Breast Retractor
10-1/4" (26 cm)

Blade Size

Long Blade 38mm x 76mm

Short Blade 25mm x 51mm

SI-PSI-786-20

SI-PSI-786-20A



TBTS-Style Spatula Breast Retractor
And Dissector
Semi-malleable

31.8 cm

Blade Size 25 mm x 15.2 mm

SI-PSI-786-21



TBTS-Style Spatulated Breast Dissector
Long Pattern

44.5 cm

Shaft Length 13" - 33 cm

SI-PSI-786-22

Paddle-Shaped Blade

Écarteur et dissecteurs
Retractor & Dissectors
Retraktor & Dissektoren
Retractor y disectores



TBTS-Style Spatulated Breast Dissector
Short Pattern
13" - 33 cm
Shaft Length 8-1/2" - 21.6 cm
SI-PSI-786-23
Paddle-Shaped Blade

MacCollum Dingman Mamaplasty Retractor
315 mm – 12 1/2"
SI-PSI-786-24

Écarteur et dissecteurs
Retractor & Dissectors
Retraktor & Dissektoren
Retractor y disectores



AGRIS-DINGMAN Breast Dissector
Right
Length 14¼"- 36 cm
SI-PSI-786-25
Graduated

AGRIS-DINGMAN Breast Dissector
Left
Length 14¼"- 36 cm
SI-PSI-786-26
Graduated

Écarteur et dissecteurs
Retractor & Dissectors
Retraktor & Dissektoren
Retractor y disectores



McCOLLUM-DINGMAN
Submammary Dissector
12" - 30 cm
SI-PSI-786-27



McCOLLUM-DINGMAN
Breast Dissector
16 ¼" - 41 cm
SI-PSI-786-28



REYNOLDS Transauxillary
Breast Dissectors Fenestrated
13" - 33 cm
Length
16" - 40 cm
SI-PSI-786-29

Écarteur et dissecteurs
Retractor & Dissectors
Retraktor & Dissektoren
Retractor y disectores

Breast Dissector
Angulated Blades

13" - 33 cm

Rigid

Length

16 ½" - 42 cm Rigid

13" - 33 cm Malleable

16 ½" - 42 cm Malleable

SI-PSI-786-30

SI-PSI-786-30A

SI-PSI-786-30B

Breast Dissector Oval
Spatulated Blades

13" - 33 cm

Rigid

Length

16 ½" - 42 cm Rigid

13" - 33 cm Malleable

16 ½" - 42 cm Malleable

SI-PSI-786-31

SI-PSI-786-31A

SI-PSI-786-31B

EMORY Style Breast Dissector
Curved, Blunt

Blade 30 cm

SI-PSI-786-32

Endodissecteurs front et lifting
Forehead and Facelift Endo Dissectors Scalp Elevators
Stirn- und Facelift Endo-Dissektoren Scalp Elevators



Scalp Elevator "S" Shaped
9 1/2" - 24 cm
Tip Size 12.5 mm
SI-PSI-786-33



Scalp Elevator Slightly curved
9 1/2" - 24 cm
Tip Size 15 mm
SI-PSI-786-34



Scalp Elevator Slightly curved
9 1/2" - 24 cm
Tip Size 12.5 mm
SI-PSI-786-35

Endodissecteurs front et lifting
Forehead and Facelift Endo Dissectors Scalp Eleavtors
Stirn- und Facelift Endo-Dissektoren Scalp Eleavtors



Scalp Elevator Fully curved
9 1/2" - 24 cm
Tip Size 7 mm
SI-PSI-786-36



Scalp Elevator Slightly curved
9 1/2" - 24 cm
Tip Size 7 mm
SI-PSI-786-37



Scalp Elevator with Suction
Slightly curved
9 3/4" - 24 cm
Tip Size 7 mm
SI-PSI-786-38

Dissecteurs frontotemporaux, frontoglabellaires
Frontotemporal, Frontoglabellar Dissectors
Frontotemporale, Frontoglabellar-Dissektoren
Disectores frontotemporales, frontoglabelares



Frontotemporal Dissector
Slightly curved
9" - 22.5 cm
Blade Width 5 mm
SI-PSI-786-39



Frontotemporal Dissector
Slightly curved
9" - 23 cm
Blade Width 7 mm
SI-PSI-786-40



Frontotemporal Dissector
Slightly curved
9" - 23 cm
Blade Width 10 mm
SI-PSI-786-41



Frontoglabellar Dissector
"S" Shaped
10 1/2" - 26.5 cm
Tip 7 mm
SI-PSI-786-42

Dissecteurs frontotemporaux, frontoglabellaires
Frontotemporal, Frontoglabellar Dissectors
Frontotemporale, Frontoglabellar-Dissektoren
Disectores frontotemporales, frontoglabelares



Flap Dissector Straight
9 ¼" - 23.5 cm
Tip Size 5 mm
SI-PSI-786-43



Zygomatic Arch Elevator Curved
8 ¼" - 20.5 cm
Tip Size 5 mm
SI-PSI-786-44



Orbital Rim Dissector
Slightly Curved
9" - 22.5 cm
Blade Width 7 mm
SI-PSI-786-45

Dissecteurs frontotemporaux, frontoglabellaires
Frontotemporal, Frontoglabellar Dissectors
Frontotemporale, Frontoglabellar-Dissektoren
Disectores frontotemporales, frontoglabelares



Temporal T-Dissector
Slightly Curved
9 1/2" - 23.5 cm
Tip 10 mm
SI-PSI-786-46



Periosteal Elevator "S" Shape
10" - 25 cm
Blade Width 12 mm
SI-PSI-786-47



Periosteal Spreader "S" Shape
9 3/4" - 24 cm
Blade Width 8 mm
SI-PSI-786-48

Jamais Protecteur et Couteau
Never Protector and Knife
Nie Beschützer und Messer
Nunca protectora y cuchillo



Periosteal Spreader "S" Shape
9 3/4" - 24 cm
Blade Width 10 mm
SI-PSI-786-49



Arcus Marginalis Dissector "S" Shaped
9 3/4" - 24 cm
Blade Width 10 mm
SI-PSI-786-50



Midface Facial Dissector Multiple curves
9 3/4" - 24 cm
Blade Width 12 mm
SI-PSI-786-51

Jamais Protecteur et Couteau
Never Protector and Knife
Nie Beschützer und Messer
Nunca protectora y cuchillo



Transoral Dissector
9 3/4" - 23.5 cm
SI-PSI-786-52



Corrugated & Procerus Muscle
Dissector Round handle
19.5 cm
Blade 4.7 mm
SI-PSI-786-53



Nerve Protector Curved Left
6 3/4" - 17 cm
Blade 4.5 mm
SI-PSI-786-54



Nerve Protector Curved Right
6 3/4" - 17 cm
Blade 4.5 mm
SI-PSI-786-55

Jamais Protecteur et Couteau
Never Protector and Knife
Nie Beschützer und Messer
Nunca protectora y cuchillo



Nerve Cutting Knife Curved
6 ³/₄" -17 cm
Blade 3 mm
SI-PSI-786-56



Knife Handle for, Plastic Surgery
8 ¹/₄" - 20.5 cm
SI-PSI-786-57



Nerve Hooks Rigid
9 ³/₄" -24 cm
SI-PSI-786-58

Jamais Protecteur et Couteau
Never Protector and Knife
Nie Beschützer und Messer
Nunca protectora y cuchillo



Nerve Hooks Left
9 1/2" -24 cm
SI-PSI-786-59



Nerve Hooks Right
9 1/2" -24 cm
SI-PSI-786-60



Nerve Dissector Cobra Style
10 1/2" - 26.5 cm
Blade Width 4.7 mm
SI-PSI-786-61

Marqueurs de poitrine et pied à coulisse
Breast Markers and Caliper
Brustmarker und Messschieber
Marcadores de mama y calibrador



Mc Kisson Areola Markers

Size

38mm

42mm

45mm

50mm

SI-PSI-787-01

SI-PSI-787-01A

SI-PSI-787-01B

SI-PSI-787-01C



Ackermann Areola Marker

Size:

14 cm

16cm

SI-PSI-787-02

SI-PSI-787-02A



Mc Kisson (Collyer) Caliper

30 cm -12"

SI-PSI-787-03

Marqueurs de poitrine et pied à coulisse
Breast Markers and Caliper
Brustmarker und Messschieber
Marcadores de mama y calibrador



Halpren Breast Caliper
Size
34mm **SI-PSI-787-04**
38mm **SI-PSI-787-04A**
42mm **SI-PSI-787-04B**



Freeman Arola Marker
Size
34mm **SI-PSI-787-05**
36mm **SI-PSI-787-05A**
38mm **SI-PSI-787-05B**
42mm **SI-PSI-787-05C**
45mm **SI-PSI-787-05D**
50mm **SI-PSI-787-05E**



Freeman Arola Marker
Size
34 / 36mm **SI-PSI-787-06**
38 / 42mm **SI-PSI-787-06A**
42 / 45mm **SI-PSI-787-06B**
45 / 50mm **SI-PSI-787-06C**



Freeman Arola Marker
Size
32mm **SI-PSI-787-07**
34mm **SI-PSI-787-07A**
36mm **SI-PSI-787-07B**
38mm **SI-PSI-787-07C**
42mm **SI-PSI-787-07D**
45mm **SI-PSI-787-07E**
50mm **SI-PSI-787-07F**

Marqueurs de poitrine et pied à coulisse
Breast Markers and Caliper
Brustmarker und Messschieber
Marcadores de mama y calibrador



Grossman Arola Marker

Size

40mm

SI-PSI-787-08

44mm

SI-PSI-787-08A

48mm

SI-PSI-787-08B

52mm

SI-PSI-787-08C



Freeman Arola Marker

Size

34mm

SI-PSI-787-09

36mm

SI-PSI-787-09A

38mm

SI-PSI-787-09B

42mm

SI-PSI-787-09C

45mm

SI-PSI-787-09D

50mm

SI-PSI-787-09E

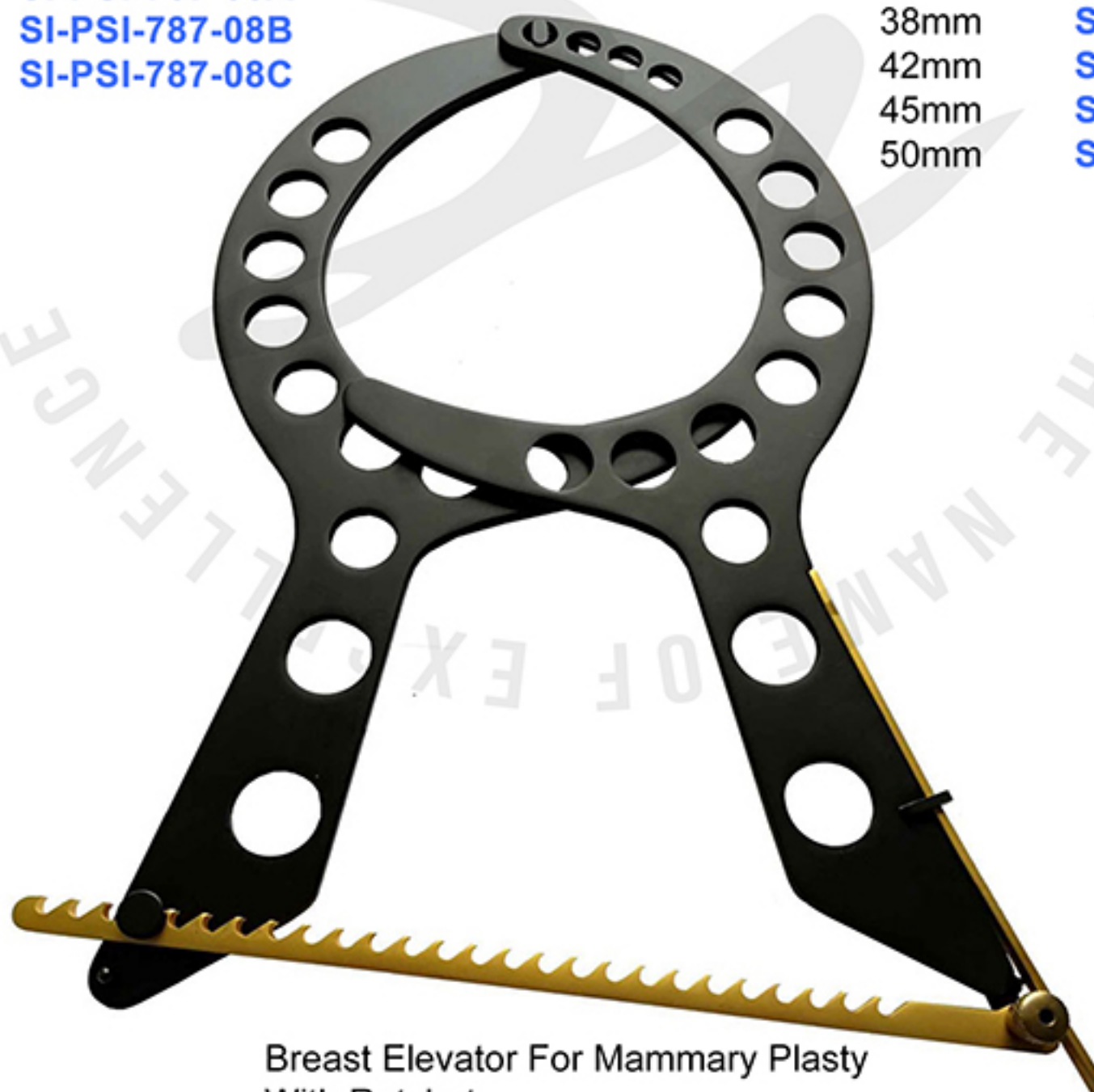

Breast Elevator For Mammary Plasty
With Ratchet

28 cm

SI-PSI-787-10

Marqueurs de poitrine et pied à coulisse
Breast Markers and Caliper
Brustmarker und Messschieber
Marcadores de mama y calibrador



Mammary Breast Retractor
With Universal Scope Connection
Blade Size

120 x 25 mm
180 x 25 mm

SI-PSI-787-11
SI-PSI-787-11A

120x25mm blade

180x25mm blade

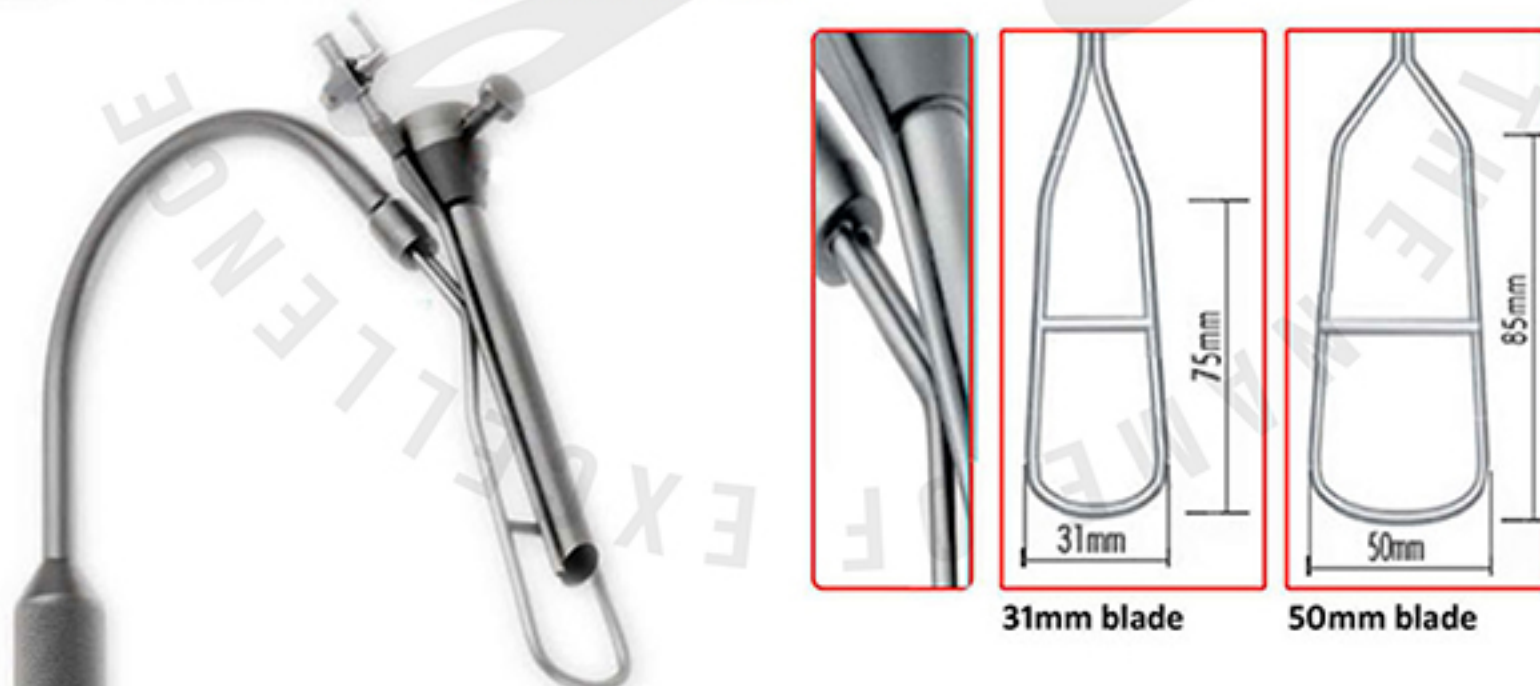

Biggs Mammary Breast Retractor
Blade Size

31 mm
For 10 mm Scopt
For 5 mm Scopt
For 4 mm Scopt
50 mm
For 10 mm Scopt

SI-PSI-787-12

SI-PSI-787-12A

31mm blade

50mm blade

Spéculums et pinces à septum
Speculas and Septum Forceps
Spekula und Septumzange
Espéculos y fórceps para tabique



Killian Nasal Specula
With Light Guide
5" - 13 cm

Working Length

- 35 mm **SI-PSI-786-65**
- 50 mm **SI-PSI-786-65A**
- 75 mm **SI-PSI-786-65B**
- 90 mm **SI-PSI-786-65C**



ASCH Septum
Straightening Forceps
9" - 23 cm
SI-PSI-786-66



Walsham Septum
Straightening Forceps
9" - 23 cm
SI-PSI-786-67
Straight
Left
Right

Écarteurs nasaux faciaux
Facial Nasal Retractors
Gesichts-Nasen-Retraktoren
Retractorres nasales faciales



BERNSTEIN Retractor Double Ended
5" - 12.6 cm
Blade Size: 8 x 46 mm
SI-PSI-786-68



CLODIUS Orbital Retractor Double Ended
13 mm / 20 mm
SI-PSI-786-69



WISE Orbital Retractor Double Ended
6 ½" -16.5 cm
SI-PSI-786-70

Écarteurs nasaux faciaux
Facial Nasal Retractors
Gesichts-Nasen-Retraktoren
Retradores nasales faciales



CRONIN Cheek Retractor Double Ended
6 ½" - 16.5 cm
SI-PSI-786-71



FISCHL Shoe Horn Retractor Double Ended
6 ¼" - 16 cm
SI-PSI-786-72



SHEEN Retractor Length 6" 15 cm
Blade 6.5 mm
SI-PSI-786-73

Écarteurs nasaux faciaux
Facial Nasal Retractors
Gesichts-Nasen-Retraktoren
Retradores nasales faciales



SHEEN Nasal Retractor 6 ¼" 16 cm
Blade 10 mm
SI-PSI-786-74



CRONIN Lip & Nostrill Retractor Double Ended
6 ¼" -15.5 cm
SI-PSI-786-75



CAROLIN Finger Retractor Double Ended
4 ¼" - 11 cm
SI-PSI-786-76

Rétracteurs de râteau
Rake Retractors
Rechen-Retraktoren
Retradores de rastrillo

FREEMAN Free-Lift Retractor
with bent neck
7" - 18 cm
Blade Size 38 mm
Prongs 4 Sharp
SI-PSI-786-77

FREEMAN Rake Retractor
7" - 18 cm
Blade Size 19 mm
Prongs 4 Blunt (2 recessed)
SI-PSI-786-78

FREEMAN Rake Retractor
7" - 18 cm
Blade Size 19 mm
Prongs 4 sharp (2 recessed)
SI-PSI-786-79

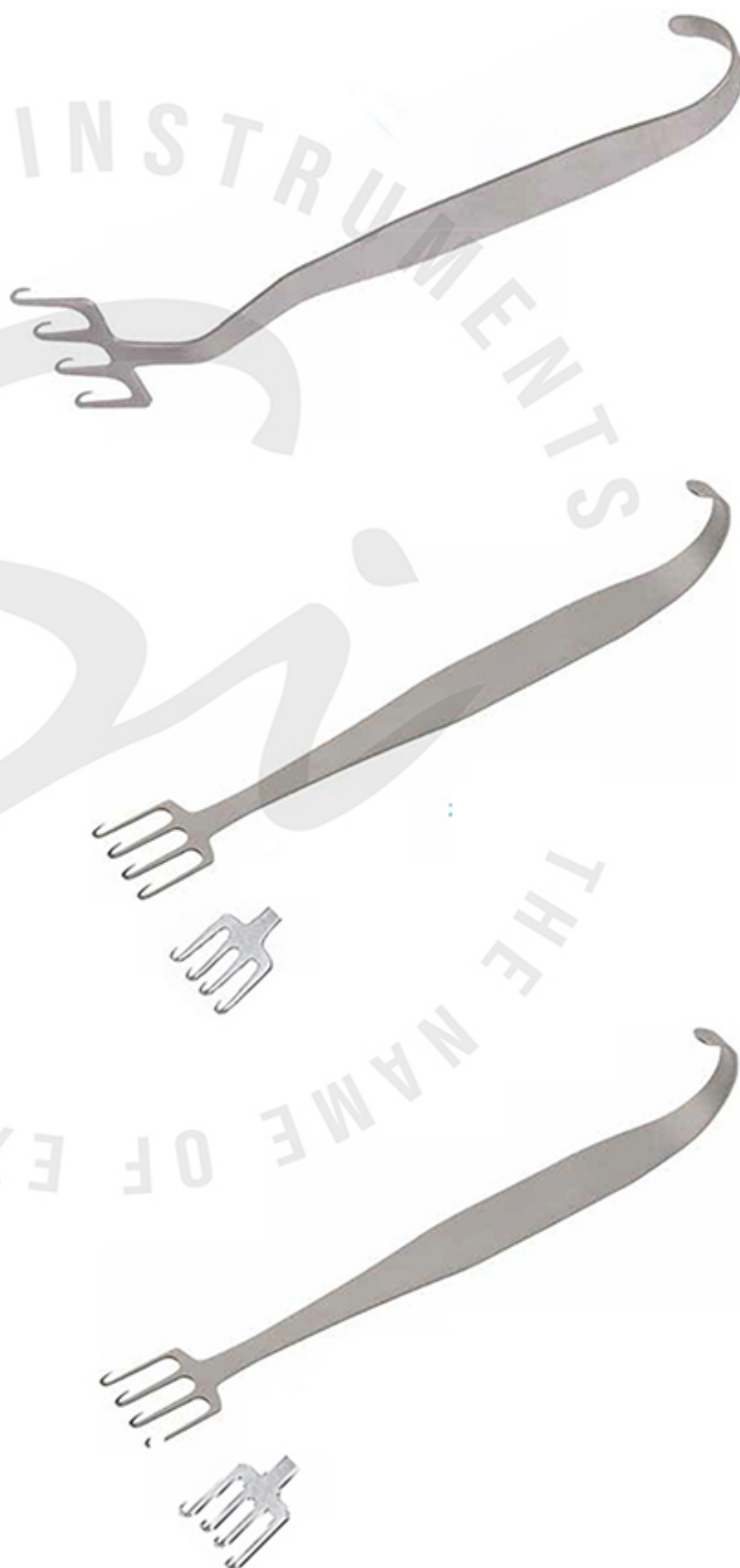

Rétracteurs de râseau
Rake Retractors
Rechen-Retraktoren
Retradores de rastrillo

FREEMAN Rake Retractor
7" - 18 cm
Blade Size 22 mm
Prongs 4 sharp
SI-PSI-786-80

FREEMAN Rake Retractor
7" - 18 cm
Blade Size 22 mm
Prongs 4 sharp (2 recessed)
SI-PSI-786-81

FREEMAN Rake Retractor
7" - 18 cm
Blade Size 38 mm
Prongs 4 sharp
SI-PSI-786-82

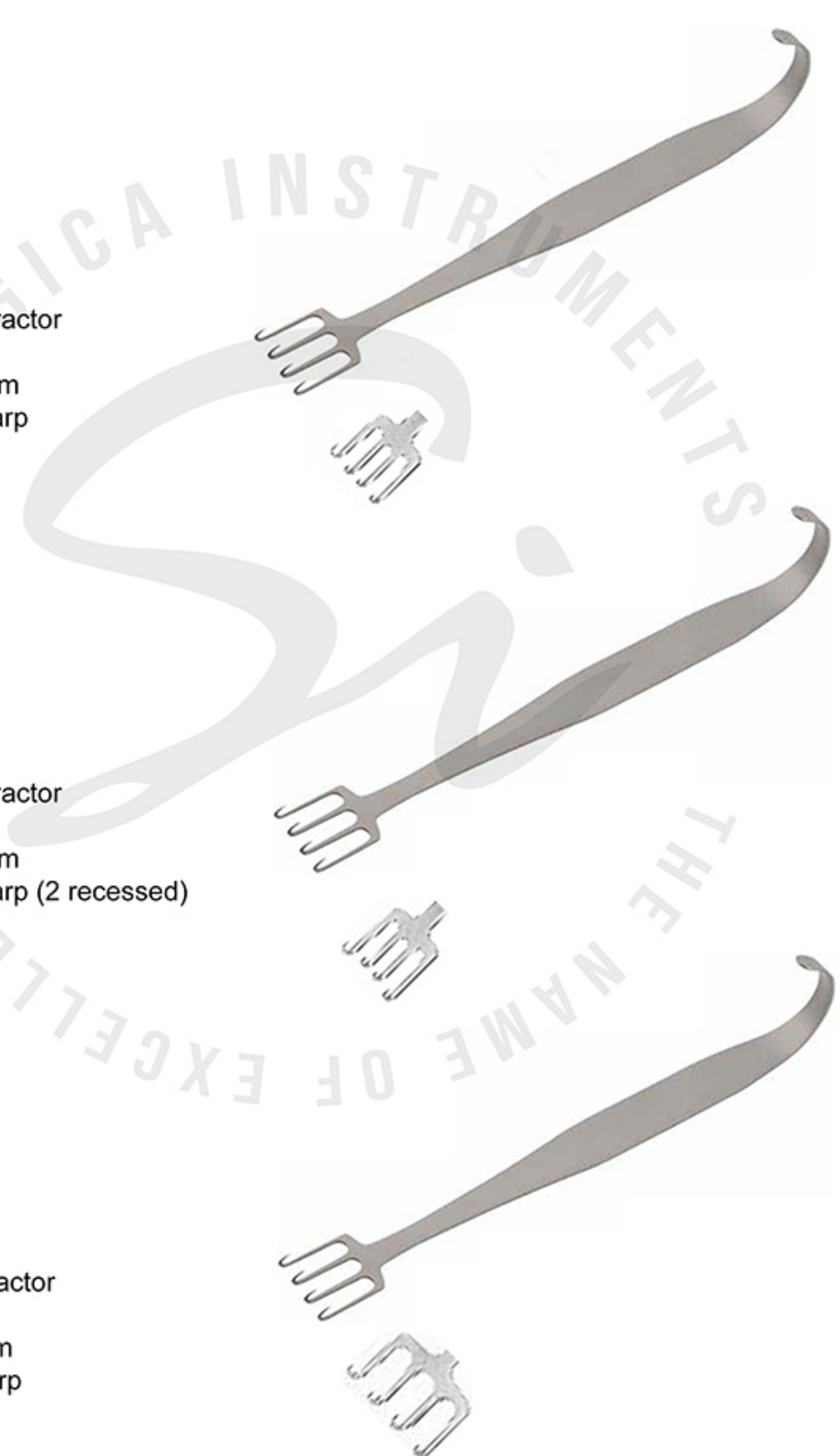

Rétracteurs de râteau
 Rake Retractors
 Rechen-Reraktoren
 Retractores de rastrillo

FREEMAN Rake Retractor
 7" - 18 cm
 Blade Size 38 mm
 Prongs 4 sharp (2 recessed)
SI-PSI-786-83

**FREEMAN Mini RAKE Retractor
 with Thumb Ring**
 2" - 5 cm
 Blade 19 mm
 Prongs 4 sharp
SI-PSI-786-84

FREEMAN Rake Retractor
 4" - 10 cm
 Prongs 4 sharp
 Blade Size
 22 mm **SI-PSI-786-85**
 38 mm **SI-PSI-786-85A**

**GORNEY Rake Retractor
 With Spring Neck**

Length	Blade Size	Code
7.5 cm	38 mm	SI-PSI-786-86
10.8 cm	38 mm	SI-PSI-786-86A

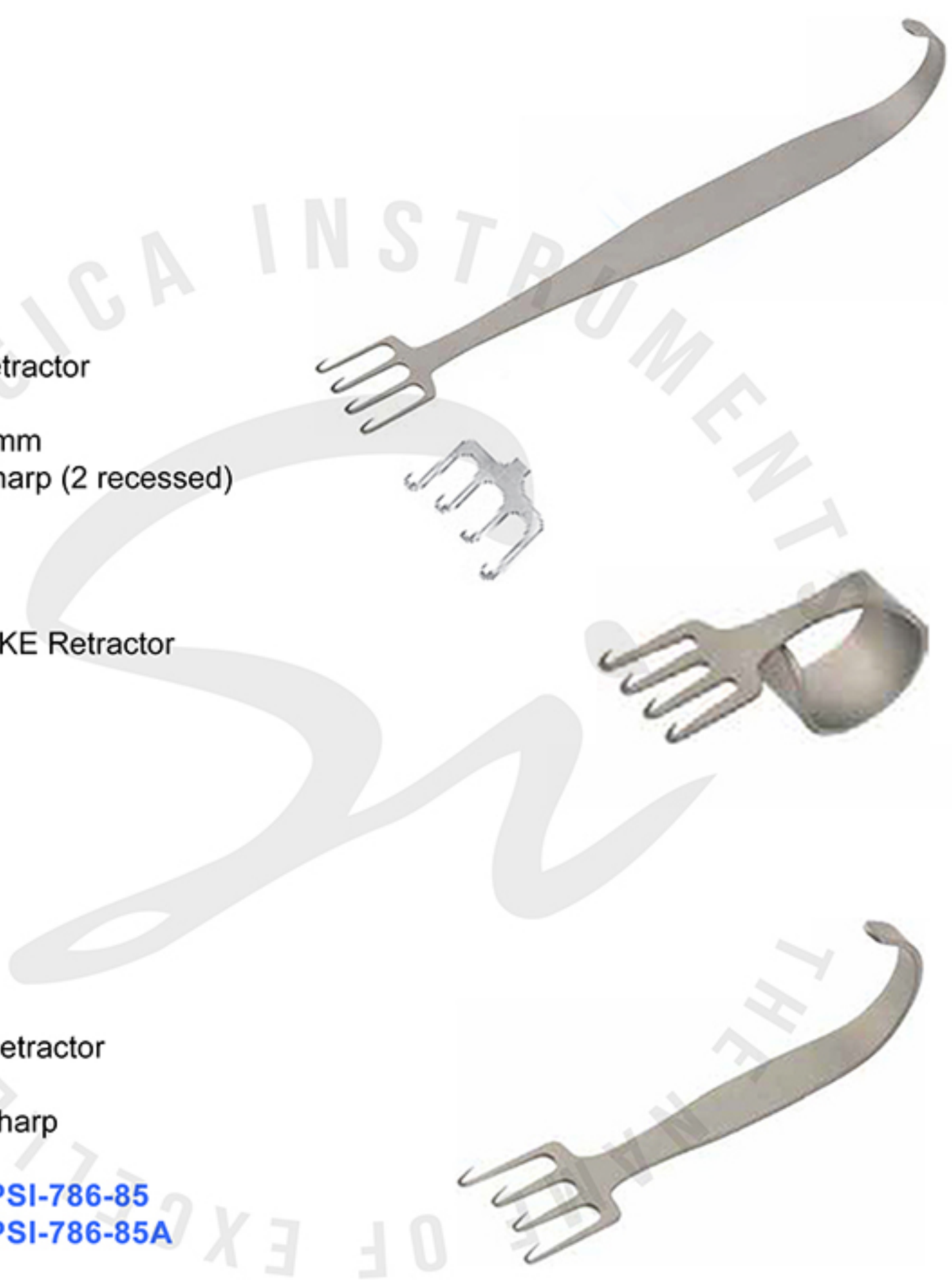

Rétracteurs de râteau
Rake Retractors
Rechen-Reraktoren
Retradores de rastrillo

MAXWELL Flap Retractor

4" - 10 cm

Blade Size

22 mm

38 mm

SI-PSI-786-87

SI-PSI-786-87A



Coronal Brow Lift Retractor

7" - 18 cm

Blade Size

70 mm

70 mm

Prongs

7 Prongs

7 Prongs

Grip Hooks

Front

Reverse

Code

SI-PSI-786-88

SI-PSI-786-88A



Coronal Lift Retractor

8 ¼" - 21 cm

Blade Width

15 cm

Prongs

6 Prongs

SI-PSI-786-89

Rétracteurs de râseau
Rake Retractors
Rechen-Retraktoren
Retradores de rastrillo



YANCOSKIE Abdominoplasty Retractor
7½" - 19 cm
Blade Width 15 cm
Prongs 6 prongs
SI-PSI-786-90



MARTINEZ KILNER Retractor With Thimble
3¼" - 8 cm
Tip 10 mm (Swivel)
Hooks 2 Sharp Hooks
SI-PSI-786-91



MARTINEZ KILNER Retractor With Thimble
4½" - 11.5 cm
Tip 7.5 mm
Hooks 2 Sharp Hooks
SI-PSI-786-92

Main orthopédique en aluminium enduit
Coated Aluminum Orthopedic Hand
Orthopädische Hand aus beschichtetem Aluminium
Mano ortopédica de aluminio revestido



Coated Aluminum Orthopedic Hand Reusable

Large 24.1 cm
Width 21.6 cm

SI-PSI-786-93



Coated Aluminum Orthopedic Hand Reusable

X - Large 33 cm
Width 26.7 cm

SI-PSI-786-94

Ciseaux délicats
Delicate Scissors
Zarte Schere
Tijeras delicadas



Iris
11.5 cm
Straight
SI-PSI-786-101
Available in
Tc
Supercut
Supercut Plus Tc

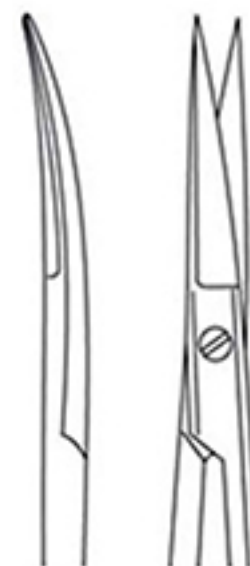

Iris
11.5 cm
Curved
SI-PSI-786-102
Available in
Tc
Supercut
Supercut Plus Tc



Iris Ribbon Handle
9.5 cm
Straight & Curved
SI-PSI-786-103
Available in
Tc
Supercut
Supercut Plus Tc



Iris Ribbon Handle
9.5 cm
Straight & Curved
SI-PSI-786-104
Available in
Tc
Supercut
Supercut Plus Tc

Ciseaux à dissection
Dissecting Scissors
Präparierschere
Tijeras de disección

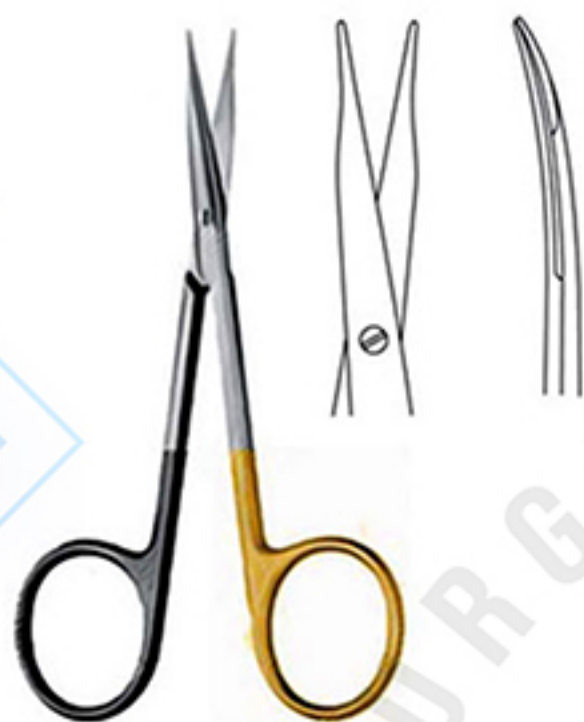

Stevens

Straight
11.5 cm
13 cm

Tc
SI-PSI-786-105
SI-PSI-786-105C

Supercut
SI-PSI-786-105A
SI-PSI-786-105D

Supercut Plus Tc
SI-PSI-786-105B
SI-PSI-786-105E

Curved
11.5 cm
13 cm

Tc
SI-PSI-786-105F
SI-PSI-786-105I

Supercut
SI-PSI-786-105G
SI-PSI-786-105J

Supercut Plus Tc
SI-PSI-786-105H
SI-PSI-786-105K

Straight
9 cm

Tc
SI-PSI-786-106

Supercut
SI-PSI-786-106A

Supercut Plus Tc
SI-PSI-786-106B

Curved
9 cm

Tc
SI-PSI-786-106C

Supercut
SI-PSI-786-106D

Supercut Plus Tc
SI-PSI-786-106E



Mini-Metzenbaum

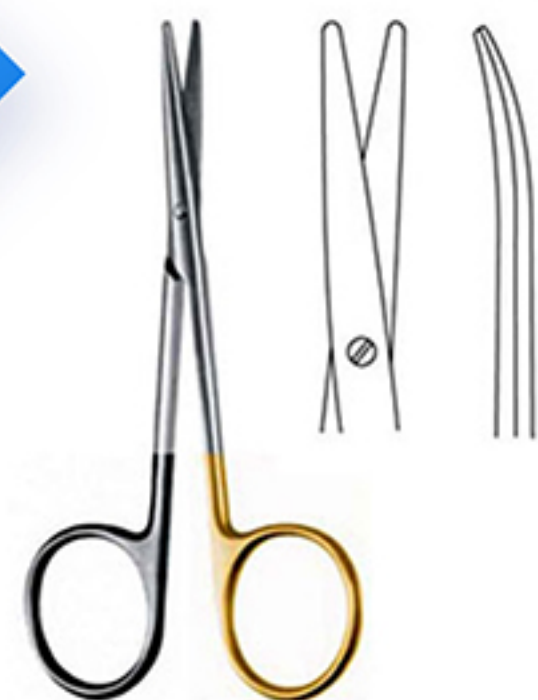

Baby-Metzenbaum

Straight
11.5 cm

Tc
SI-PSI-786-107

Supercut
SI-PSI-786-107A

Supercut Plus Tc
SI-PSI-786-107B

Curved
11.5 cm

Tc
SI-PSI-786-107C

Supercut
SI-PSI-786-107D

Supercut Plus Tc
SI-PSI-786-107E

Ciseaux à dissection
Dissecting Scissors
Präparierschere
Tijeras de disección



Metzenbaum

		Tc	Supercut	Supercut Plus Tc
Straight	14 cm	SI-PSI-786-108	SI-PSI-786-108A	SI-PSI-786-108B
	15 cm	SI-PSI-786-109	SI-PSI-786-109A	SI-PSI-786-109B
	18 cm	SI-PSI-786-110	SI-PSI-786-110A	SI-PSI-786-110B
	20 cm	SI-PSI-786-111	SI-PSI-786-111A	SI-PSI-786-111B
Curved	14 cm	SI-PSI-786-108C	SI-PSI-786-108D	SI-PSI-786-108E
	15 cm	SI-PSI-786-109C	SI-PSI-786-109D	SI-PSI-786-109E
	18 cm	SI-PSI-786-110C	SI-PSI-786-110D	SI-PSI-786-110E
	20 cm	SI-PSI-786-111C	SI-PSI-786-111D	SI-PSI-786-111E



Metzenbaum-Slim

		Tc	Supercut	Supercut Plus Tc
Straight	14 cm	SI-PSI-786-112	SI-PSI-786-112A	SI-PSI-786-112B
	15 cm	SI-PSI-786-113	SI-PSI-786-113A	SI-PSI-786-113B
	18 cm	SI-PSI-786-114	SI-PSI-786-114A	SI-PSI-786-114B
	20 cm	SI-PSI-786-115	SI-PSI-786-115A	SI-PSI-786-115B
Curved	14 cm	SI-PSI-786-112C	SI-PSI-786-112D	SI-PSI-786-112E
	15 cm	SI-PSI-786-113C	SI-PSI-786-113D	SI-PSI-786-113E
	18 cm	SI-PSI-786-114C	SI-PSI-786-114D	SI-PSI-786-114E
	20 cm	SI-PSI-786-115C	SI-PSI-786-115D	SI-PSI-786-115E

Ciseaux à dissection
Dissecting Scissors
Präparierschere
Tijeras de disección



Mayo

	Straight	Tc	Supercut	Supercut Plus Tc
14 cm	SI-PSI-786-116	SI-PSI-786-116A	SI-PSI-786-116A	SI-PSI-786-116B
15 cm	SI-PSI-786-117	SI-PSI-786-117A	SI-PSI-786-117A	SI-PSI-786-117B
17 cm	SI-PSI-786-118	SI-PSI-786-118A	SI-PSI-786-118A	SI-PSI-786-118B
23 cm	SI-PSI-786-119	SI-PSI-786-119A	SI-PSI-786-119A	SI-PSI-786-119B

	Curved	Tc	Supercut	Supercut Plus Tc
14 cm	SI-PSI-786-116C	SI-PSI-786-116D	SI-PSI-786-116D	SI-PSI-786-116E
15 cm	SI-PSI-786-117C	SI-PSI-786-117D	SI-PSI-786-117D	SI-PSI-786-117E
17 cm	SI-PSI-786-118C	SI-PSI-786-118D	SI-PSI-786-118D	SI-PSI-786-118E
23 cm	SI-PSI-786-119C	SI-PSI-786-119D	SI-PSI-786-119D	SI-PSI-786-119E



Mayo-Style

	Straight	Tc	Supercut	Supercut Plus Tc
15 cm	SI-PSI-786-120	SI-PSI-786-120A	SI-PSI-786-120A	SI-PSI-786-120B
17 cm	SI-PSI-786-121	SI-PSI-786-121A	SI-PSI-786-121A	SI-PSI-786-121B

	Curved	Tc	Supercut	Supercut Plus Tc
15 cm	SI-PSI-786-120C	SI-PSI-786-120D	SI-PSI-786-120D	SI-PSI-786-120E
17 cm	SI-PSI-786-121C	SI-PSI-786-121D	SI-PSI-786-121D	SI-PSI-786-121E

Ciseaux délicats
Delicate Scissors
Zarte Schere
Tijeras delicadas



Doyen

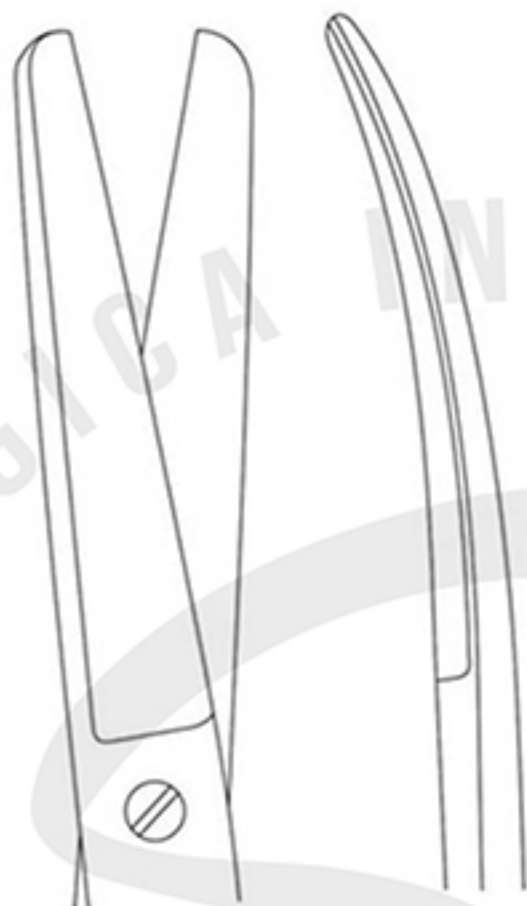

Straight
18 cm

Tc

SI-PSI-786-122

Supercut

SI-PSI-786-122A

Supercut Plus Tc
SI-PSI-786-122B

Curved
18 cm

Tc

SI-PSI-786-122C

Supercut

SI-PSI-786-122D

Supercut Plus Tc
SI-PSI-786-122E



Sims



Straight
20 cm
23 cm

Tc

SI-PSI-786-123

SI-PSI-786-123C

Supercut

SI-PSI-786-123A

SI-PSI-786-123D

Supercut Plus Tc
SI-PSI-786-123B
SI-PSI-786-123E

Curved
20 cm
23 cm

Tc

SI-PSI-786-123F

SI-PSI-786-123I

Supercut

SI-PSI-786-123G

SI-PSI-786-123J

Supercut Plus Tc
SI-PSI-786-123H
SI-PSI-786-123K

Ciseaux délicats
Delicate Scissors
Zarte Schere
Tijeras delicadas



Siebold



24.5 cm

Tc

SI-PSI-786-124

Supercut

SI-PSI-786-124A

Supercut Plus Tc

SI-PSI-786-124B



25 cm

Tc

SI-PSI-786-125

Supercut

SI-PSI-786-125A

Supercut Plus Tc

SI-PSI-786-125B



Resano

Ciseaux délicats
Delicate Scissors
Zarte Schere
Tijeras delicadas



Ragnell(Kilner)

13 cm
15 cm
18 cm

Tc
SI-PSI-786-126
SI-PSI-786-127
SI-PSI-786-128

Supercut
SI-PSI-786-126A
SI-PSI-786-127A
SI-PSI-786-128A

Supercut Plus Tc
SI-PSI-786-126B
SI-PSI-786-127B
SI-PSI-786-128B



Peck-Joseph

Straight
14 cm

Tc
SI-PSI-786-129

Supercut
SI-PSI-786-129A

Supercut Plus Tc
SI-PSI-786-129B



Curved
14 cm

Tc
SI-PSI-786-129C

Supercut
SI-PSI-786-129D

Supercut Plus Tc
SI-PSI-786-129E



Ciseaux délicats
Delicate Scissors
Zarte Schere
Tijeras delicadas



Metzenbaum-Freeman

18 cm
20 cm
23 cm

Tc
SI-PSI-786-130
SI-PSI-786-131
SI-PSI-786-132

Supercut
SI-PSI-786-130A
SI-PSI-786-131A
SI-PSI-786-132A

Supercut Plus Tc
SI-PSI-786-130B
SI-PSI-786-131B
SI-PSI-786-132B

Straight
16.5 cm
20.5 cm

Tc
SI-PSI-786-133
SI-PSI-786-134

Supercut
SI-PSI-786-133A
SI-PSI-786-134A

Supercut Plus Tc
SI-PSI-786-133B
SI-PSI-786-134B

Curved
16.5 cm
20.5 cm

Tc
SI-PSI-786-133C
SI-PSI-786-134C

Supercut
SI-PSI-786-133D
SI-PSI-786-134D

Supercut Plus Tc
SI-PSI-786-133E
SI-PSI-786-134E



Fanous

Ciseaux délicats
Delicate Scissors
Zarte Schere
Tijeras delicadas



Gorney Facelift

17 cm



Tc

SI-PSI-786-135

Supercut

SI-PSI-786-135A

Supercut Plus Tc

SI-PSI-786-135B



Gorney-Freeman Facelift

17 cm

Tc

SI-PSI-786-136

Supercut

SI-PSI-786-136A

Supercut Plus Tc

SI-PSI-786-136B



PLASTIC SURGERY INSTRUMENTS

Pinces artérielles et pinces à serviettes
Artery Forceps and Towel Clamps
Arterienzangen und Handtuchklemmen
Fórceps arteriales y pinzas para toallas



Baby Mosquito
10 cm
Straight
SI-PSI-786-137



Baby Mosquito
10 cm
Curved
SI-PSI-786-138

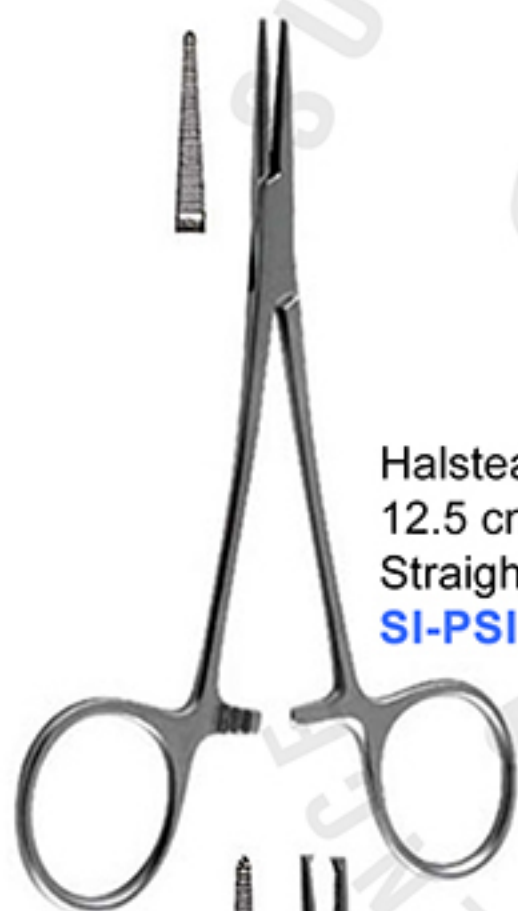

Halstead Mosquito
12.5 cm
Straight
SI-PSI-786-139



Halstead Mosquito
12.5 cm
Curved
SI-PSI-786-140



Kocher Mosquito
12.5 cm
Straight
SI-PSI-786-141



Kocher Mosquito
12.5 cm
Curved
SI-PSI-786-142

Pinces artérielles et pinces à serviettes
Artery Forceps and Towel Clamps
Arterienzangen und Handtuchklemmen
Fórceps arteriales y pinzas para toallas



Bakhaus
8 cm **SI-PSI-786-143**
11 cm **SI-PSI-786-143A**
13 cm **SI-PSI-786-143B**



Martel Flap Grasping Forceps
Two pins in opposing holes on the jaws
14 cm
SI-PSI-786-144



Marten Flap Forceps
For accurate marking of skin flaps
14 cm
SI-PSI-786-145



Ptanguy Forceps
Flap demarcator for accurate
marking of faicial flaps for excision
15 cm **SI-PSI-786-146**
26 cm **SI-PSI-786-146A**



Assumpcao Facelift Forceps
For prescise marking of dissected
faicial flaps for excision
16 cm
SI-PSI-786-147

Porte-aiguilles
Needle Holders
Nadelhalter
Portaagujas



Halsey
13 cm
Smooth
SI-PSI-786-148



Halsey TC
13 cm
Smooth
SI-PSI-786-149



Hegar Baumgartner
14 cm
SI-PSI-786-150



Derf
12 cm
SI-PSI-786-151



Derf TC
12 cm
SI-PSI-786-152

Porte-aiguilles
Needle Holders
Nadelhalter
Portaagujas



Webster TC
12.5 cm
Smooth
SI-PSI-786-153



Kilner
13.5 cm
SI-PSI-786-154



Kilner TC
13.5 cm
SI-PSI-786-155



Mayo-Hegar
18 cm
SI-PSI-786-156

Porte-aiguilles
Needle Holders
Nadelhalter
Portaagujas



Mayo-Hegar
16 cm
SI-PSI-786-157



Mayo-Hegar TC
18 cm
SI-PSI-786-158



Mayo-Hegar TC
16 cm
SI-PSI-786-159



Crile Wood TC
15 cm
SI-PSI-786-160

Micro-ciseaux
Micro Scissors
Mikroschere
Micro Tijeras



Barraquer
5 cm **SI-PSI-786-161**
7 cm **SI-PSI-786-161A**
10 cm **SI-PSI-786-161B**



Wecker
Fig. 1 **SI-PSI-786-162**
Fig. 2 **SI-PSI-786-163**
Fig. 3 **SI-PSI-786-164**



Westcott
12 cm
SI-PSI-786-165



Westcott Curved
11 cm
SI-PSI-786-166

Micro-ciseaux
Micro Scissors
Mikroschere
Micro Tijeras



Vannas
8 cm
Straight
Curved
Angular

SI-PSI-786-167
SI-PSI-786-168
SI-PSI-786-169



Katzin
10 cm
SI-PSI-786-170



Katzin
10 cm
SI-PSI-786-171



Weatcott
11 cm
SI-PSI-786-172

Micro-ciseaux
Micro Scissors
Mikroschere
Micro Tijeras



Weatcott
11 cm
Curved
Straight

SI-PSI-786-173
SI-PSI-786-174



Weatcott
19 cm
Straight
Curved

SI-PSI-786-175
SI-PSI-786-176



Micro Scissor
15 cm
Curved
Straight

SI-PSI-786-177
SI-PSI-786-178

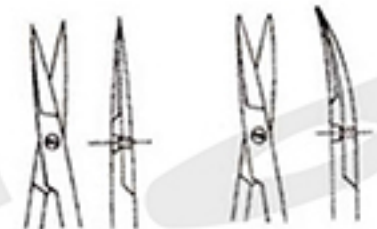

Noyes
12 cm
Sharp/Sharp
Sharp/Blunt
Blunt/Blunt

SI-PSI-786-179
SI-PSI-786-180
SI-PSI-786-181



Micro-ciseaux
Micro Scissors
Mikroschere
Micro Tijeras



Noyes
12 cm
SI-PSI-786-182



Katzin-Barraquer
10 cm
SI-PSI-786-183



Katzin-Barraquer
10 cm
SI-PSI-786-184



Micro Scissor
10 cm
SI-PSI-786-185



Castroviejo
10 cm
SI-PSI-786-186



Micro Scissor
10 cm
SI-PSI-786-187

Micro-ciseaux
Micro Scissors
Mikroschere
Micro Tijeras



Troutman Right
10 cm
SI-PSI-786-188



Troutman Left
10 cm
SI-PSI-786-189



Castroviejo
11 cm
SI-PSI-786-190



Castroviejo
11 cm
SI-PSI-786-191



Micro Scissor
15 cm
SI-PSI-786-192



Micro Scissor
16 cm
Straight **SI-PSI-786-193**
Curved **SI-PSI-786-194**

Micro porte-aiguille
Micro Needle holder
Mikronadelhalter
Soporte para microagujas



Castroviejo
9 cm
Straight **SI-PSI-786-196**
Curved **SI-PSI-786-195**



Castroviejo
14 cm
Straight **SI-PSI-786-198**
Curved **SI-PSI-786-197**



Castroviejo
14 cm
Straight **SI-PSI-786-200**
Curved **SI-PSI-786-199**



Castroviejo
14 cm
Straight **SI-PSI-786-202**
Curved **SI-PSI-786-201**

Micro porte-aiguille
Micro Needle holder
Mikronadelhalter
Soporte para microagujas



Castroviejo
14 cm
SI-PSI-786-203



Castroviejo TC
14 cm
Curved **SI-PSI-786-204**
Straight **SI-PSI-786-205**



Castroviejo
13 cm
Curved **SI-PSI-786-206**
Straight **SI-PSI-786-207**



Castroviejo TC
9cm **SI-PSI-786-208**
13 cm **SI-PSI-786-208A**

Micro porte-aiguille
Micro Needle holder
Mikronadelhalter
Soporte para microaguja



Barraquer
14 cm
Curved
Straight

SI-PSI-786-209
SI-PSI-786-210



Barraquer
11 cm
SI-PSI-786-211



Barraquer
14 cm
SI-PSI-786-212



Barraquer TC
13 cm
SI-PSI-786-213

Micro porte-aiguille
Micro Needle holder
Mikronadelhalter
Soporte para microaguja



Arruga
14 cm
Curved
Straight

SI-PSI-786-214
SI-PSI-786-215



Barraguer
11 cm
SI-PSI-786-216



Kalt
14 cm
SI-PSI-786-217



Kalt
14 cm
SI-PSI-786-218

PLASTIC SURGERY INSTRUMENTS

Pinces à pansement, pinces à tissus
Dressing Forceps, Tissue Forceps
Verbandzange, Gewebezange
Pinzas para vendajes, pinzas para tejidos



Dressing Forceps
13 cm
SI-PSI-786-219



Tissue Forceps
13 cm
1 x 2 Teeth
SI-PSI-786-220



Micro Adson
12 cm
SI-PSI-786-221



Micro Adson
12 cm
1 x 2 Teeth
SI-PSI-786-222



Adson Brown
12 cm
SI-PSI-786-223



Semken
12 cm
Straight
SI-PSI-786-224

PLASTIC SURGERY INSTRUMENTS

Pinces à pansement, pinces à tissus
Dressing Forceps, Tissue Forceps
Verbandzange, Gewebezange
Pinzas para vendajes, pinzas para tejidos



Semken
12 cm
Curved
SI-PSI-786-225



Potts-Smth
18 cm
SI-PSI-786-226



Potts-Smth
18 cm
1 x 2 Teeth
SI-PSI-786-227



Debbakey
15 cm
SI-PSI-786-228



Cushing
17 cm
Curved
SI-PSI-786-229



Cushing
17 cm
Straight
SI-PSI-786-230

Pinces à pansement, pinces à tissus
Dressing Forceps, Tissue Forceps
Verbandzange, Gewebezange
Pinzas para vendajes, pinzas para tejidos



Lucae
14 cm
SI-PSI-786-231



Gruenwald (Jansen)
16 cm
SI-PSI-786-232



Jweller's Style (Watchmaker)
12 cm
SI-PSI-786-233



Jweller's Style (Watchmaker)
12 cm
SI-PSI-786-234

Si



SURGICA INSTRUMENTS

SURGICA UNIT ADDRESS
MUHAMMAD PURA COMMISSIONER
ROAD, SIALKOT-51310, PAKISTAN

TEL: +92 52 4598741

MOBILE: +92 312 7782800

EMAIL: INFO@SURGICA-INTL.COM

EMAIL: ASLAM@SURGICA-INTL.COM

WEBSITE: WWW.SURGICA-INTL.COM

REGARDS

MIAN MUHAMMAD ASLAM

CEO

TEL: +92 52 4598741

MOBILE: +92 337 0464548

EMAIL: ASAD@SURGICA-INTL.COM

WEBSITE: WWW.SURGICA-INTL.COM

REGARDS,

ASAD ALI

MANAGING DIRECTOR