



Surgi
SURGICA
INSTRUMENTS

THE NAME OF EXCELLENCE



SURGICAL INSTRUMENTS
GYNECOLOGY
UROLOGY
OTHER



<https://surgica-intl.com>



At the Mid of the nineteenth century, Nawab-deen established a little manufacturing unit in Sialkot. They had very good experience in the field of surgical instruments manufacturing. Nawab- deen was my grandfather. He was expert in making Gynecology and Urology Instruments. In 1985, our expert grandfather passed away.

But his older son, Muhammad Rafiq, continued where he left it. At that time, we did not have a international market due to lack of technical education and financial problems. Muhammad Rafiq worked for Pakistani companies and various local manufacturing contracts. In 1990 Muhammad Rafiq's younger brother, Muhammad Munir, joined his older brother. Both brothers worked very hard and established a name, a brand in Pakistan.

In 1993, Muhammad Rafiq's sons joined their father's business. Out of the five, only two were successful. Muhammad Asgher and Muhammad Aslam both brothers worked very hard to continue the family legacy.



In 2004 Muhammad Rafiq also passed away. That time was very critical for both their sons. But Muhammad Asgher worked hard and worked smart and got a high and well respected reputation in our field.

In 2010, the idea to grab the international market was introduced. But Mohammad Asghar thought to himself, that he did not have the communication skills for this endeavor. Muhammad Aslam hired his nephew and registered Surgica Instruments company in 2014. But he could not handle the workload so he left.

At that time, Muhammad Munir's youngest son, Asad Ali was doing his bachelor's degree. Muhammad Aslam requested his uncle to let him join the office on part time basis. Uncle agreed and Asad joined the company in 2015. In a span of just 550 days, Asad Ali became experienced in the field and started working with the international community. In 2016, Asad Ali got his bachelor's degree and started working full-time.

Nowadays, we are working with top brands in Czech Republic, Germany, Italy, Norway, Sweden, England, USA, South Africa and with many other countries. Thank you for reading this till the end. This is my life story. I am Asad Ali and welcome to Surgica Instruments.

CONTENT

- **DIAGNOSTICS, ANAESTHESIA**
- **ASPIRATION PROBES**
- **PLASTER INSTRUMENTS**
- **SCAPELS,KNIVES**
- **SCHEREN SCISSORS**
- **HAEMOSTATIC FORCEPS**
- **DRESSING AND DISSECTING FORCEPS**
- **GYNECOLOGY INSTRUMENTS**
- **UROLOGY INSTRUMENTS**
- **MAGEN, DARM – STOMACH, INTESTINES**
- **WUNDHAKEN – RETRACTORS**
- **ORTHOPEDIC – BONE SURGERY INSTRUMENTS**
- **ENT INSTRUMENTS**
- **MICRO- & NEURO SURGERY**
- **SUTURE INSTRUMENTS**
- **NEEDLE HOLDERS**
- **VASCULAR SURGERY**
- **MISCELLANEOUS**

Si

***Si* SURGICA**
INSTRUMENTS
THE NAME OF EXCELLENCE



DIAGNOSTICS, ANAESTHESIA

- PERCUSSION HAMMERS
- STETHOSCOPES
- MEASURING INSTRUMENTS
- TONGUE DEPRESSORS
- STANDARD AND FIBER OPTIC LARYNGOSCOPES
- ENT DIAGNOSTIC SETS

Marteaux-percuteurs
Percussion Hammers
Martillos de percusión
Martelli percussori



Babinsky
220 mm
SI-786-1-101

Rabiner
230 mm
SI-786-1-102

Wartenberg
190 mm – 7"
SI-786-1-103



Buck
180 mm – 7"
SI-786-1-104

Buck
200 mm – 8"
SI-786-2-104

Troemner
240 mm – 9 1/2"
SI-786-1-105

Marteaux-percuteurs
Percussion Hammers
Martillos de percusión
Martelli percussori



Taylor
180 mm – 7" **SI-786-1-106**
200 mm – 8" **SI-786-1-106A**



Berliner
200 mm – 8" **SI-786-1-107**



Déjerine
210 mm – 8" **SI-786-1-108**



Lor Déjerine
210 mm – 8" **SI-786-2-108**



Reflex
320 mm **SI-786-2-109**



Traube
160 mm – 6 1/4" **SI-786-2-107**

Stéthoscopes
Stethoscopes
Estetoscopios
Stetoscopi



Pinard
180 mm – 7"
SI-786-1-109
Holz
Wood
Bois
Madera
Legno



Pinard
150 mm – 6"
SI-786-1-110
Aluminium
Aluminium
Aluminium
Aluminio
Alluminio



Pinard
150 mm – 6"
SI-786-2-110
Aluminium
Aluminium
Aluminium
Aluminio
Alluminio

Stéthoscopes
Stethoscopes
Estetoscopios
Stetoscopi



Baby-Duplex
37 mm
SI-786-3-111
For children

Duplex
47 mm
SI-786-3-111A
For Adult



Anestophon
47 mm
SI-786-3-112
For Nurses, simple

Instruments pour mesurer
Measuring instruments
Instrumentos de medidas
Strumenti di misura



Bertillon
320 mm – 12 1/2 "
SI-MI-5-1



Moeltgen
240 mm – 9 1/2 "
SI-MI-5-2



Vernier
210 mm – 8 1/4 "
Aluminium **SI-MI-5-3**
Steel **SI-MI-5-3A**

Instruments pour mesurer
Measuring instruments
Instrumentos de medidas
Strumenti di misura

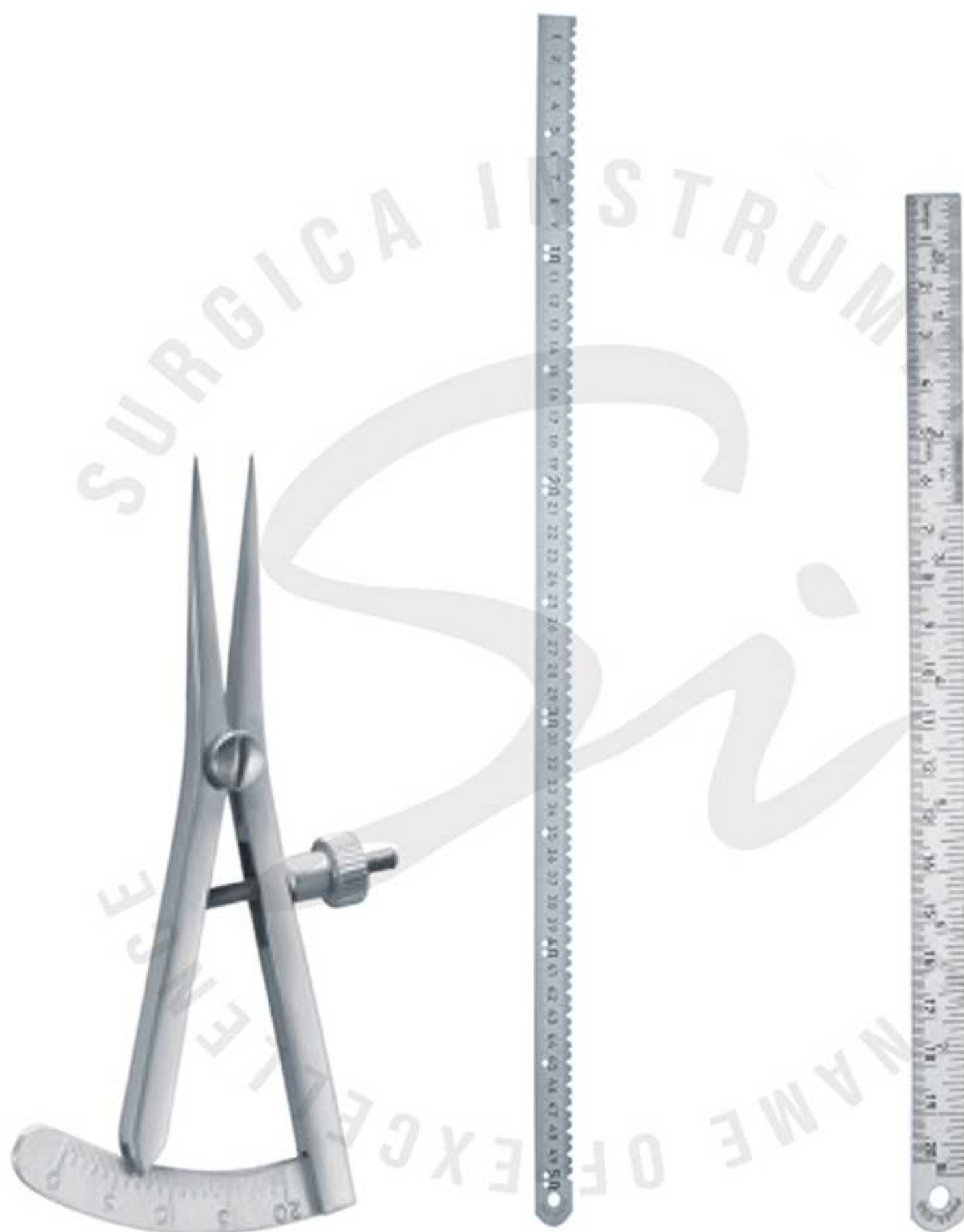

Castroviejo
80 mm – 3 1/4 "
SI-MI-5-4

X-Ray Ruler
500 mm – 20 "
SI-MI-5-5

Scale
100 mm – 4 " **SI-MI-5-6**
150 mm – 6 " **SI-MI-5-6A**
200 mm – 8 " **SI-MI-5-6B**
300 mm – 12 " **SI-MI-5-6C**
500 mm – 20 " **SI-MI-5-6D**

Abaisse-langues
Tongue depressors
Espatulas bucales
Abbassalingua



Tongue Depressors
160 mm – 6 1/4
SI-786-1-111



Tongue Depressors
145 mm – 5 3/4 "
SI-786-1-112



Kroenig
150 mm – 6 "
SI-786-1-113



Mayo
170 mm – 6 3/4 "
SI-786-1-114



Bruenings
190 mm – 7 1/2 "
SI-786-1-115



Frenzel
165 mm – 6 1/2 "
SI-786-1-116



Wieder
150 mm – 6 " **SI-786-1-117**
140 mm – 5 1/2 **SI-786-1-117A**



150 mm



140 mm

SI-786-1-117 SI-786-1-117A

Abaisse-langues
Tongue depressors
Espatulas bucales
Abbassalingua



Bosworth
145 mm – 5 3/4 "
SI-786-1-118



Tobold
145 mm – 5 3/4 "
SI-786-1-119



Hartmann
150 mm – 6 "
SI-786-1-120



1 Pair rubber-inserts

Andrew
110 mm – 4 3/4 "
SI-786-1-121

Young Tongue Holding Forceps
170 mm – 6 3/4 "
SI-786-1-122

Collin Tongue Holding Forceps
160 mm – 6 1/4 " **SI-786-1-123**
170 mm – 6 3/4 " **SI-786-1-123A**
190 mm – 7 1/2 " **SI-786-1-123B**

Laryngoscopes
Laryngoscopes
Laringoscopios
Laringoscopi

Mc - Intosh Laryngoscopes Standard Illumination

SI-LS-786-01

Handle Standard Illumination

Size: Adult

Handle options: Child & Stubby

Blade Size:

(1) Size: 0

(2) Size: 1

(3) Size: 2

(4) Size: 3

(5) Size: 4

Standard Sets:

(1) Set of 3 Blades Size 0, 1, 2 and Adult Handle:

(2) Set of 3 Blades Size 1, 2, 3 and Adult Handle:

(3) Set of 4 Blades Size 0, 1, 2, 3 and Adult Handle:

(4) Set of 4 Blades Size 1, 2, 3, 4 and Adult Handle:

Sets Available in Hard Case or Soft Pouch

Material:

AISI 304 Stainless Steel

Autoclavable



Mc - Intosh Laryngoscopes Fiber Optic Illumination

SI-LS-786-02

Handle Fiber Optic Illumination

Size: Adult

Handle options: Child & Stubby

Blade Size:

(1) Size: 0

(2) Size: 1

(3) Size: 2

(4) Size: 3

(5) Size: 4

Standard Sets:

(1) Set of 3 Blades Size 0, 1, 2 and Adult Handle:

(2) Set of 3 Blades Size 1, 2, 3 and Adult Handle:

(3) Set of 4 Blades Size 0, 1, 2, 3 and Adult Handle:

(4) Set of 4 Blades Size 1, 2, 3, 4 and Adult Handle:

Sets Available in Hard Case or Soft Pouch

Material:

AISI 304 Stainless Steel

Autoclavable

Fiber Optic Handle with 3.5 mm Dia for Improved Light



Laryngoscopes
Laryngoscopes
Laringoscopios
Laringoscopi

Miller Laryngoscopes Standard Illumination

SI-LS-786-03

Handle Standard Illumination

Size: Child / Infant

Handle options: Adult & Stubby

Blade Size:

(1) Size: 00

(2) Size: 0

(3) Size: 1

(4) Size: 2

(5) Size: 3

Standard Sets:

(1) Set of 3 Blades Size 00, 0, 1 and Child Handle:

(2) Set of 3 Blades Size 0, 1, 2 and Child Handle:

(3) Set of 4 Blades Size 00, 0, 1, 2 and Child Handle:

(4) Set of 4 Blades Size 0, 1, 2, 3 and Child Handle:

Sets Available in Hard Case or Soft Pouch

Material:

AISI 304 Stainless Steel

Autoclavable

Handle Requires 2 * AA Size Batteries



Miller Laryngoscopes Fiber Optic Illumination

SI-LS-786-04

Handle Fiber Optic Illumination

Size: Adult

Handle options: Child & Stubby

Blade Size:

(1) Size: 0

(2) Size: 1

(3) Size: 2

(4) Size: 3

(5) Size: 4

Standard Sets:

(1) Set of 3 Blades Size 0, 1, 2 and Adult Handle:

(2) Set of 3 Blades Size 1, 2, 3 and Adult Handle:

(3) Set of 4 Blades Size 0, 1, 2, 3 and Adult Handle:

(4) Set of 4 Blades Size 1, 2, 3, 4 and Adult Handle:

Sets Available in Hard Case or Soft Pouch

Material:

AISI 304 Stainless Steel

Autoclavable

Fiber Optic Handle with 3.5 mm Dia for Improved Light



Laryngoscopes
Laryngoscopes
Laringoscopios
Laringoscopi

Mc - Intosh Integrated Laryngoscopes Fiber Optic Illumination

SI-LS-786-05

Handle Fiber Optic Illumination

Size: Adult

Handle options: Child & Stubby

Blade Size:

(1) Size: 00

(2) Size: 0

(3) Size: 1

(4) Size: 2

(5) Size: 3

(6) Size: 4

Standard Sets:

(1) Set of 3 Blades Size 00, 0, 1 and Adult Handle:

(2) Set of 3 Blades Size 1, 2, 3 and Adult Handle:

(3) Set of 4 Blades Size 0, 1, 2, 3 and Adult Handle:

(4) Set of 4 Blades Size 1, 2, 3, 4 and Adult Handle:

Sets Available in Hard Case or Soft Pouch

Material:

AISI 304 Stainless Steel

Autoclavable

Fiber Optic Handle with 3.5 mm Dia for Improved Light



McCoy Flexi - Tip Laryngoscopes Fiber Optic Illumination

SI-LS-786-06

Size: Adult

Handle Fiber Optic Illumination

Blade Size:

(1) Size: 1

(2) Size: 2

(3) Size: 3

Standard Sets:

Set of 2 Blades Size 2, 3 and Adult Handle:

Set of 2 Blades Size 3, 4 and Adult Handle:

Set of 3 Blades Size 2, 3, 4 and Adult Handle:

Sets available in hard case or soft pouch:

Material:

AISI 304 Stainless Steel

Autoclavable

Fiber Optic Handle with 3.5 mm Dia for Improved Light

Flaxible Tip for Dificult Intubation



Laryngoscopes
Laryngoscopes
Laringoscopios
Laringoscopi

McCoy Flexi - Tip Integrated Laryngoscopes Fiber Optic Illumination

SI-LS-786-07

Size: Adult
Handle Fiber Optic Illumination
Blade Size:
(1) Size: 1
(2) Size: 2
(3) Size: 3
Standard Sets:
Set of 2 Blades Size 2, 3 and Adult Handle:
Set of 2 Blades Size 3, 4 and Adult Handle:
Set of 3 Blades Size 2, 3, 4 and Adult Handle:
Sets available in hard case or soft pouch:
Material:
AISI 304 Stainless Steel
Autoclavable
Flexible Tip for Difficult Intubation
Fiber Optic Handle with 3.5 mm Dia for Improved Light



McCoy Flexi - Tip Laryngoscopes Standard Illumination

SI-LS-786-08

Size: Adult
Handle Standard Illumination:
Blade Size:
(1) Size: 1
(2) Size: 2
(3) Size: 3
Standard Sets:
Set of 2 Blades Size 2, 3 and Adult Handle:
Set of 2 Blades Size 3, 4 and Adult Handle:
Set of 3 Blades Size 2, 3, 4 and Adult Handle:
Sets available in hard case or soft pouch:
Material:
AISI 304 Stainless Steel
Autoclavable
Flexible Tip for Difficult Intubation



Trousses à diagnose
Diagnostic sets
Juegos para diagnóstico
Astucci diagnostici



Mini Oscope Fiber Optic Illumination

SI-LS-786-09

Complete Set of Disposable Cannulas
Manufactured From Plastic Material
3x Magnifying glass
Available in Halogen and LED Illumination
Bulbs 2.5V
Handles requires 2 x AA size batteries
09 Fiber Optic Light Source
Soft Pouch available in matching colors



Otoscope Standard Illumination

SI-LS-786-10 A

Standard Illumination
Brass Chrome plated
Screw Lock fitting System
Reusable speculas of 2mm, 3mm, 4mm
Hard Case and Soft Pouch available
Handles requires 2 x C size batteries
Bulbs 2.5V
Available in Halogen and LED Illumination
3x Magnifying glass
Manufactured From Brass Chrome plated



Otoscope Standard Illumination Set

SI-LS-786-10

Standard Illumination
Brass Chrome plated
Bayonet Lock Fitting System
Reusable Speculas of 2mm, 3mm, 4mm
Hard Case and Soft Pouch available
Handles requires 2 x C size batteries
Bulbs 2.5V
Available in Halogen and LED Illumination
3x Magnifying glass
Manufactured From Brass Chrome plated

Trousses à diagnose
Diagnostic sets
Juegos para diagnóstico
Astucci diagnostici



Fiber Optic
Plastic Head With
Brass Chrome Plated
Complete Set Of Disposable
Cannulas
SI-LS-786-11



Fiber Optic
Brass Chrome Plated
Complete Set Of Disposable
Cannulas
SI-LS-786-12



Fiber Optic
Brass Chrome Plated
Complete Set Of Disposable
Cannulas
SI-LS-786-13

Trousses à diagnose
Diagnostic sets
Juegos para diagnóstico
Astucci diagnostici



Standard Illumination
Brass Chrome Plated
Screw Lock Fitting System
Color Coded 24 Lenses Wheel
From -20 to +40
Rubber Eye Brow Rest
Handle requires 2x C Size Batteries
SI-LS-786-14



Standard Illumination
Brass Chrome Plated
Bayonet Lock Fitting System
Color Coded 24 Lenses Wheel
From -20 to +40
Rubber Eye Brow Rest
Handle requires 2x C Size Batteries
SI-LS-786-15



Standard Illumination
Full Plastic Material Construction
Rubber Eye Brow Rest
Handle requires 2x AA Size Batteries
SI-LS-786-16

Trousses à diagnose
Diagnostic sets
Juegos para diagnóstico
Astucci diagnostici



Standard Illumination
Otoscope Head
3x Magnification
Bayonet Locking Fitting System
Also Available In Screw Lock
Ophthalmoscope color Coded 24 Lenses
Wheel from -20 to +40
Rubber Eye Brow Rest
Handle Requires 2x C Size Batteries
Reusable Speculas of 2 mm, 3 mm, 4 mm
Brass Chrome Plated And Plastic Construction
SI-LS-786-17



Standard Illumination
Otoscope Head
3x Magnification
Bayonet Locking Fitting System
Also Available In Screw Lock
Ophthalmoscope color Coded 24 Lenses
Wheel from -20 to +40
Rubber Eye Brow Rest
Handle Requires 2x C Size Batteries
Reusable Speculas of 2 mm, 3 mm, 4 mm
Spacula adaptor
Complete Set of Disposable Cannulas
Brass Chrome Plated And Plastic Construction
SI-LS-786-18

Trousses à diagnose
Diagnostic sets
Juegos para diagnóstico
Astucci diagnostici



Vetrinary Diagnostic Set

Standard Illumination
Otoscope Head
3x Magnification
Bayonet Locking Fitting System
Ophthalmoscope color Coded 24 Lenses
Wheel from -20 to +40
Rubber Eye Brow Rest
Handle Requires 2x C Size Batteries
Reusable Speculas of 4 mm, 5 mm, 6 mm 7 mm
Spreader Nasal Speculum
Bent Arm Illuminator
Tongue Depressor
Brass Chrome Plated And Plastic Construction

SI-LS-786-19



Nasal Speculum
SI-LS-786-20



Nasal Speculum
SI-LS-786-21

Trousses à diagnose
Diagnostic sets
Juegos para diagnóstico
Astucci diagnostici



Nasal Speculum
SI-LS-786-22



Bulb
SI-LS-786-23



Bulb
SI-LS-786-24



Bulb
SI-LS-786-25



Bulb
SI-LS-786-26



Ear Speculas
SI-LS-786-27



Ear Speculas
SI-LS-786-28



Ear Speculas
SI-LS-786-29



Ear Speculas
SI-LS-786-30



Ear Speculas
SI-LS-786-31



Ear Speculas
SI-LS-786-32

Trousses à diagnose
Diagnostic sets
Juegos para diagnóstico
Astucci diagnostici



Packing Option
SI-LS-786-33



Packing Option
SI-LS-786-34



Packing Option
SI-LS-786-35



Packing Option
SI-LS-786-36
SI-LS-786-36A

S*i* SURGICA
INSTRUMENTS
THE NAME OF EXCELLENCE



ASPIRATION PROBES

- TROCARS
- SUCTION TUBES
- EUSTACHIAN CATHETERS
- EAR SYRINGE
- SUCTION AND IRRIGATION CANNULAS
- PROBES AND DIRECTORS
- COTTON APPLICATORS

Trocarts
Trocars
Trócares
Trequarti



Fig. 1 6.0 mm Ø Fig. 2 4.5 mm Ø Fig. 3 3.0 mm Ø Fig. 4 1.75 mm Ø

Universal Trocar Set
SI-786-1-126



3.5 mm Ø 5.0 mm Ø 5.0 mm Ø
SI-786-1-128 SI-786-1-128A SI-786-1-128B

Sinus Trocars 170 mm – 6 3/4"

Uckermann Trocar
130 mm – 5"
SI-786-1-127

Trocarts
Trocars
Trócares
Trequarti



Lichtwitz Trocars 190 mm – 7 1/2 "
1.8 mm Ø **SI-786-1-129**
2.0 mm Ø **SI-786-1-129A**



Ochsner Trocars 100 mm – 4 "

3 1/3 mm Ø	10 Char./Fr.	SI-786-1-130
4 mm Ø	12 Char./Fr.	SI-786-1-130A
4 2/3 mm Ø	14 Char./Fr.	SI-786-1-130B
5 1/3 mm Ø	16 Char./Fr.	SI-786-1-130C
6 mm Ø	18 Char./Fr.	SI-786-1-130D
6 2/3 mm Ø	20 Char./Fr.	SI-786-1-130E
7 1/3 mm Ø	22 Char./Fr.	SI-786-1-130F
8 mm Ø	24 Char./Fr.	SI-786-1-130G
8 2/3 mm Ø	26 Char./Fr.	SI-786-1-130H
9 1/3 mm Ø	28 Char./Fr.	SI-786-1-130I

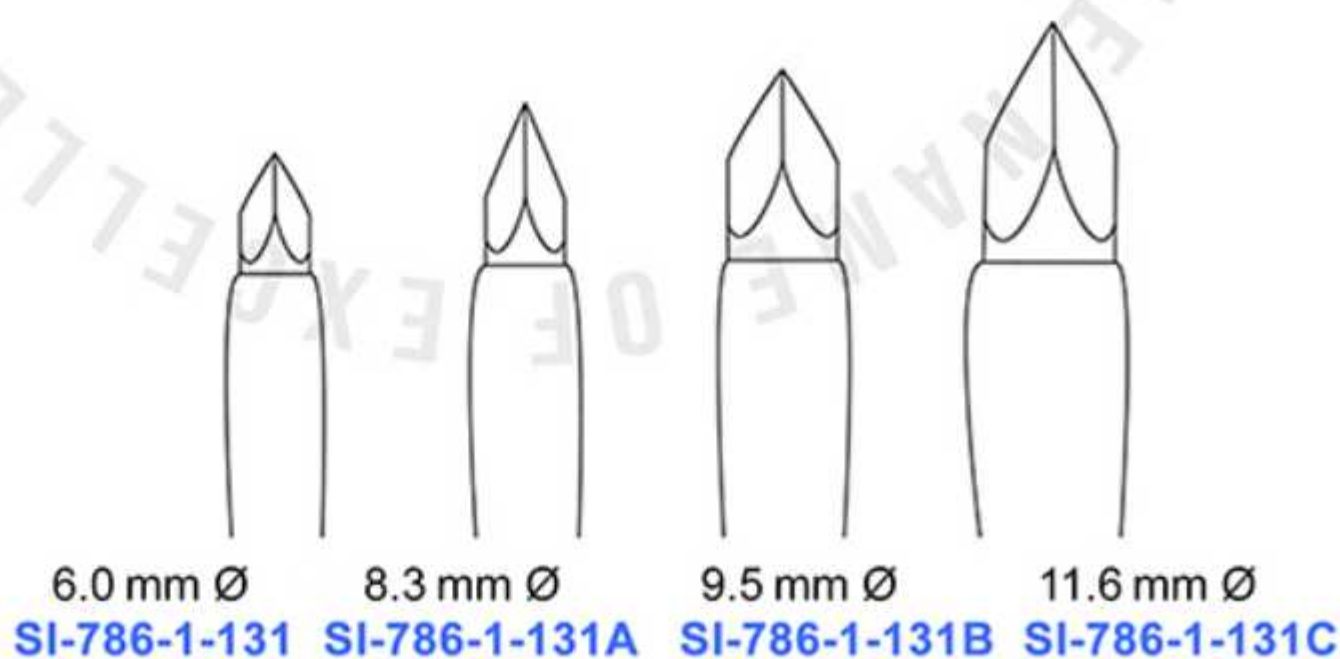

6.0 mm Ø **SI-786-1-131** 8.3 mm Ø **SI-786-1-131A** 9.5 mm Ø **SI-786-1-131B** 11.6 mm Ø **SI-786-1-131C**

Nelson Trocars 210 mm – 8 1/4 "

Trocarts
Trocars
Trócares
Trequarti



Landau Trocars 160 mm – 6 1/4 "
2 mm Ø
SI-786-1-132



3 mm Ø **SI-786-1-133**
4 mm Ø **SI-786-1-133A**
5 mm Ø **SI-786-1-133B**
Pierce Trocars 170 mm – 6 3/4 "



Krause Trocars 150 mm – 6 "
5.5 mm Ø
SI-786-1-134



Coakley Trocars 160 mm – 6 1/4 "
2.25 mm Ø
SI-786-1-135

Trocarts
Trocars
Trócares
Trequarti



Standard

3 mm	Ø	SI-786-2-136
3.5 mm	Ø	SI-786-2-136A
4 mm	Ø	SI-786-2-136B
4.5 mm	Ø	SI-786-2-136C
5 mm	Ø	SI-786-2-136D
5.5 mm	Ø	SI-786-2-136E
6 mm	Ø	SI-786-2-136F

Standard

3 mm	Ø	SI-786-2-137
3.5 mm	Ø	SI-786-2-137A
4 mm	Ø	SI-786-2-137B
4.5 mm	Ø	SI-786-2-137C
5 mm	Ø	SI-786-2-137D
5.5 mm	Ø	SI-786-2-137E
6 mm	Ø	SI-786-2-137F

Pierce
170 mm

3 mm	Ø	SI-786-2-138
4 mm	Ø	SI-786-2-138A
5 mm	Ø	SI-786-2-138B

Trocarts
Trocars
Trócares
Trequarti



Standard
3 mm Ø **SI-786-2-139**
3.5 mm Ø **SI-786-2-139A**
4 mm Ø **SI-786-2-139B**
4.5 mm Ø **SI-786-2-139C**
5 mm Ø **SI-786-2-139D**
5.5 mm Ø **SI-786-2-139E**
6 mm Ø **SI-786-2-139F**

Buelau 240 mm
8 mm Ø
SI-786-2-140

Douglas
3 mm Ø
SI-786-2-141



Lichtwitz
1.75 mm Ø
SI-786-2-142

Krause
5.5 mm Ø
SI-786-2-143

Canules d'aspiration
Suction tubes
Tubos de aspiración
Tubi per aspirazione



Cooley
350 mm – 13 3/4 "
8 mm Ø
SI-786-1-136



Cooley
310 mm – 12 1/4 "
10 mm Ø
SI-786-1-137



Cooley
300 mm – 12 "
6 mm Ø
SI-786-1-138



Cooley
330 mm – 13 "
8 mm Ø
SI-786-1-139



Poole
220 mm – 8 " 8 mm Ø
23 Charr./Fr
SI-786-1-140



Poole
220 mm – 8 " 10 mm Ø
30 Charr./Fr
SI-786-1-141



Andrews-Pyncheon
235 mm – 9 1/4 "
SI-786-1-142



De Bakey
275 mm – 10 3/4 "
SI-786-1-143

Canules d'aspiration
Suction tubes
Tubos de aspiración
Tubi per aspirazione

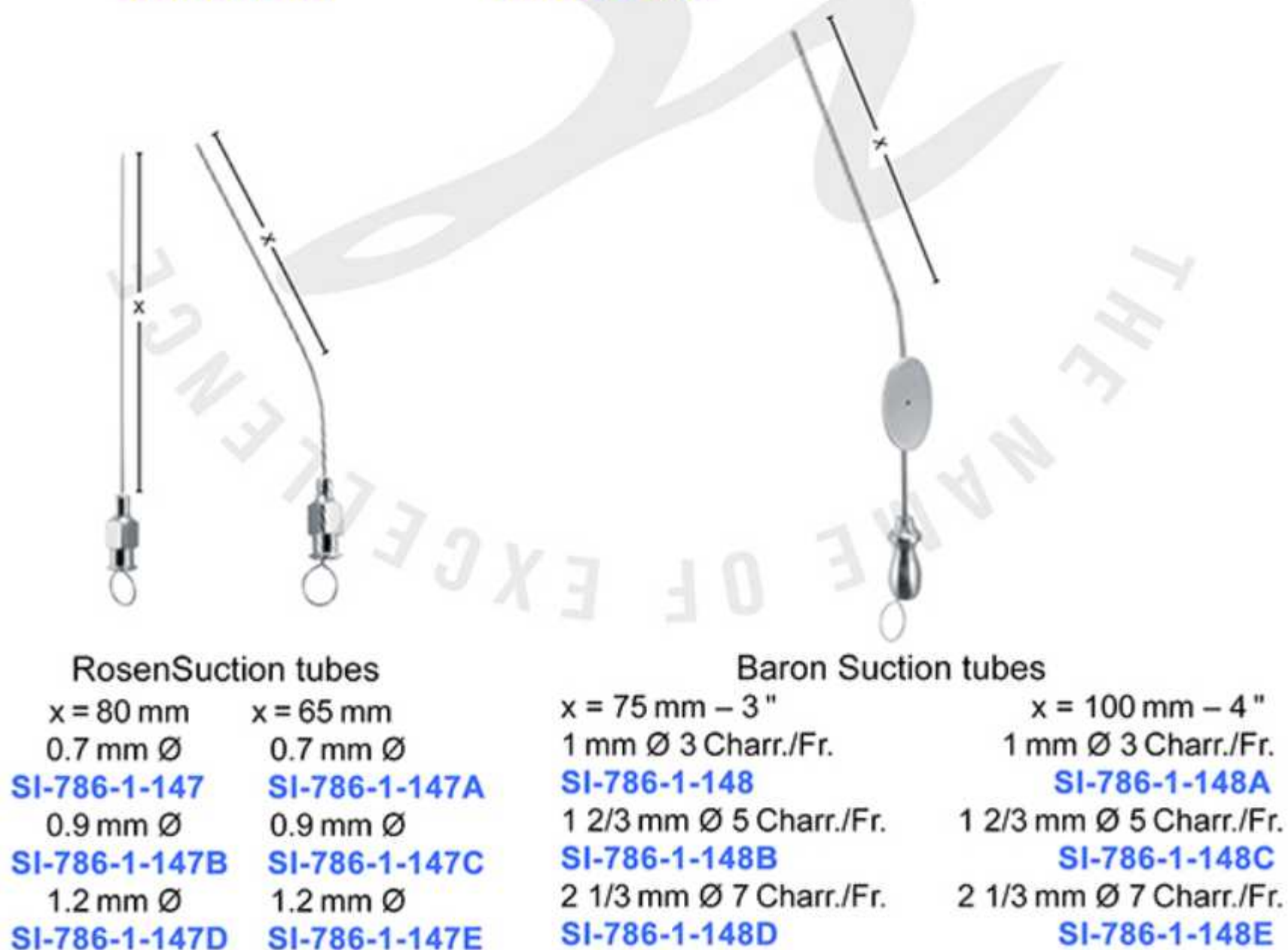

Tubes d'aspiration
Suction tubes
Tubos para aspiración
Cannule d'aspirazione



House Suction tubes
x = 75 mm – 3"

- 1 mm Ø 3 Charr./Fr.
SI-786-1-149
- 1 2/3 mm Ø 5 Charr./Fr.
SI-786-1-149B
- 2 1/3 mm Ø 7 Charr./Fr.
SI-786-1-149D
- 2 2/3 mm Ø 8 Charr./Fr.
SI-786-1-149F
- 3 1/3 mm Ø 10 Charr./Fr.
SI-786-1-149J
- 4 mm Ø 12 Charr./Fr.
SI-786-1-149L
- 4 2/3 mm Ø 14 Charr./Fr.
SI-786-1-149N

x = 100 mm – 4"

- 1 mm Ø 3 Charr./Fr.
SI-786-1-149A
- 1 2/3 mm Ø 5 Charr./Fr.
SI-786-1-149C
- 2 1/3 mm Ø 7 Charr./Fr.
SI-786-1-149E
- 2 2/3 mm Ø 8 Charr./Fr.
SI-786-1-149I
- 3 1/3 mm Ø 10 Charr./Fr.
SI-786-1-149K
- 4 mm Ø 12 Charr./Fr.
SI-786-1-149M
- 4 2/3 mm Ø 14 Charr./Fr.
SI-786-1-149O



Fergusson Suction tubes
x = 120 mm – 4 3/4"

- 2 mm Ø 6 Charr./Fr. **SI-786-1-150**
- 2 1/3 mm Ø 7 Charr./Fr. **SI-786-1-150A**
- 2 2/3 mm Ø 8 Charr./Fr. **SI-786-1-150B**
- 3 mm Ø 9 Charr./Fr. **SI-786-1-150C**
- 3 1/3 mm Ø 10 Charr./Fr. **SI-786-1-150D**
- 4 mm Ø 12 Charr./Fr. **SI-786-1-150E**
- 5 mm Ø 15 Charr./Fr. **SI-786-1-150F**

Tubes d'aspiration
Suction tubes
Tubos para aspiración
Cannule d'aspirazione



Plester Suction tubes
170 mm – 6 3/4 "

- 2 mm Ø 6 Charr./Fr.
- 2 1/3 mm Ø 7 Charr./Fr.
- 2 2/3 mm Ø 8 Charr./Fr.
- 3 mm Ø 9 Charr./Fr.
- 3 1/3 mm Ø 10 Charr./Fr.
- 3 2/3 mm Ø 11 Charr./Fr.
- 4 mm Ø 12 Charr./Fr.
- 5 mm Ø 15 Charr./Fr.

- SI-786-1-151**
- SI-786-1-151A**
- SI-786-1-151B**
- SI-786-1-151C**
- SI-786-1-151D**
- SI-786-1-151E**
- SI-786-1-151F**
- SI-786-1-151G**



Adson Suction tubes
210 mm – 8 1/4 "



Suction raspatory
200 mm – 8 "
malleable, sharp
SI-786-1-153

- 4 mm Ø 12 Charr./Fr.
- SI-786-1-152**
- 5 mm Ø 15 Charr./Fr.
- SI-786-1-152A**



Frazier Suction tubes 170 mm – 6 3/4 "

- 2 mm Ø 6 Charr./Fr.
- 2 1/3 mm Ø 7 Charr./Fr.
- 2 2/3 mm Ø 8 Charr./Fr.
- 3 mm Ø 9 Charr./Fr.
- 3 1/3 mm Ø 10 Charr./Fr.
- 4 mm Ø 12 Charr./Fr.
- 5 mm Ø 15 Charr./Fr.



Tubes d'aspiration
Suction tubes
Tubos para aspiración
Cannule d'aspirazione

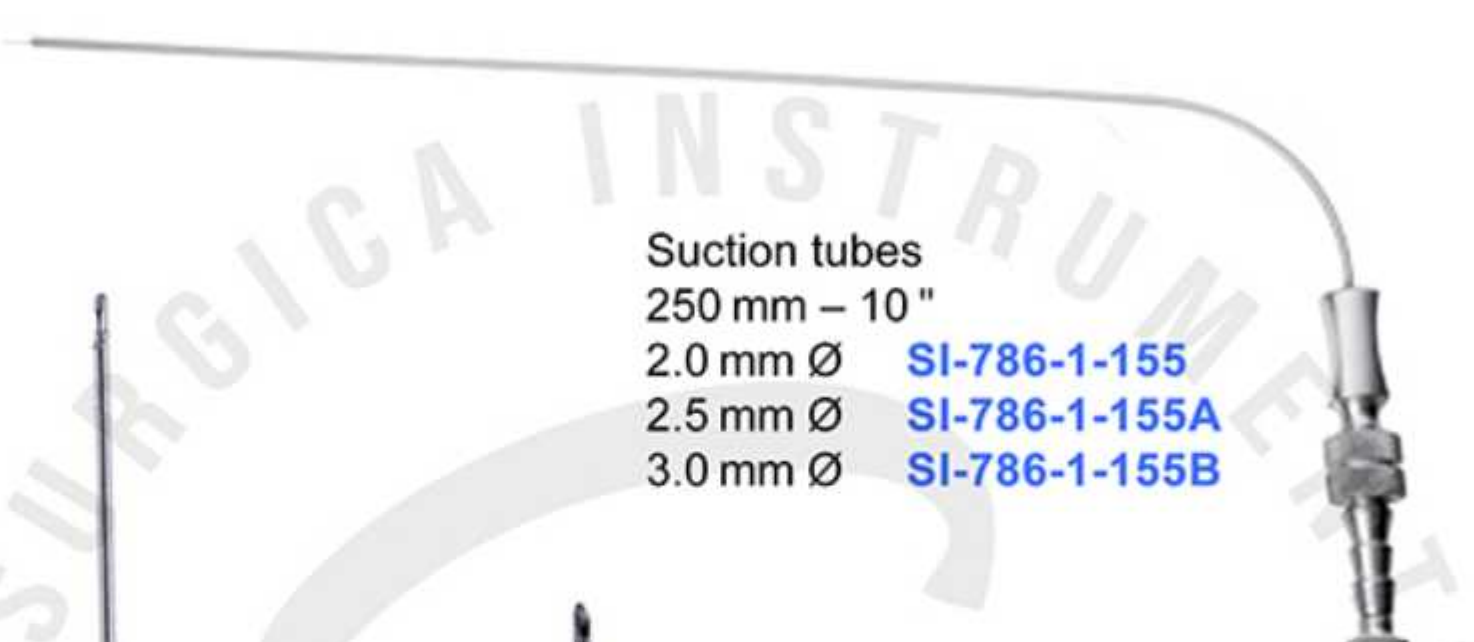

Suction tubes
250 mm – 10"
2.0 mm Ø **SI-786-1-155**
2.5 mm Ø **SI-786-1-155A**
3.0 mm Ø **SI-786-1-155B**



Verres Biopsy Needle
2 x 100 mm **SI-786-2-156**
2 x 120 mm **SI-786-2-156A**
2 x 150 mm **SI-786-2-156B**



Klima-Rosegger
1.8 x 35 mm
SI-786-2-157



Bier biopsy Needle
1.2 x 80 mm **SI-786-2-158**
1.2 x 90 mm **SI-786-2-158A**



Gorney
180 mm
SI-786-2-159

Tubes d'aspiration
Suction tubes
Tubos para aspiración
Cannule d'aspirazione



Bule Rectal Aspiration Cannula

2 mm Ø	6 Charr./Fr.	SI-786-2-162
2 1/3 mm Ø	7 Charr./Fr.	SI-786-2-162A
2 2/3 mm Ø	8 Charr./Fr.	SI-786-2-162B
3 mm Ø	9 Charr./Fr.	SI-786-2-162C
3 1/3 mm Ø	10 Charr./Fr.	SI-786-2-162D
4 mm Ø	12 Charr./Fr.	SI-786-2-162E
5 mm Ø	15 Charr./Fr.	SI-786-2-162F



Fergusson Suction tubes
x = 190 mm – 7 1/2 "

2 mm Ø	6 Charr./Fr.	SI-786-2-161
2 1/3 mm Ø	7 Charr./Fr.	SI-786-2-161A
2 2/3 mm Ø	8 Charr./Fr.	SI-786-2-161B
3 mm Ø	9 Charr./Fr.	SI-786-2-161C
3 1/3 mm Ø	10 Charr./Fr.	SI-786-2-161D
4 mm Ø	12 Charr./Fr.	SI-786-2-161E
5 mm Ø	15 Charr./Fr.	SI-786-2-161F

Tubes d'aspiration
Suction tubes
Tubos para aspiración
Cannule d'aspirazione



Suction tubes
180 mm – 7"

2 mm Ø	SI-786-2-163
3 mm Ø	SI-786-2-163A
4 mm Ø	SI-786-2-163B
5 mm Ø	SI-786-2-163C

Baron (Schuknecht)

1.0 x 75 mm Ø	SI-786-2-164
1.5 x 75 mm Ø	SI-786-2-164A
2.0 x 75 mm Ø	SI-786-2-164B

Sondes auriculaires
Eustachian catheters
Sondas auriculares
Sonde auricolari

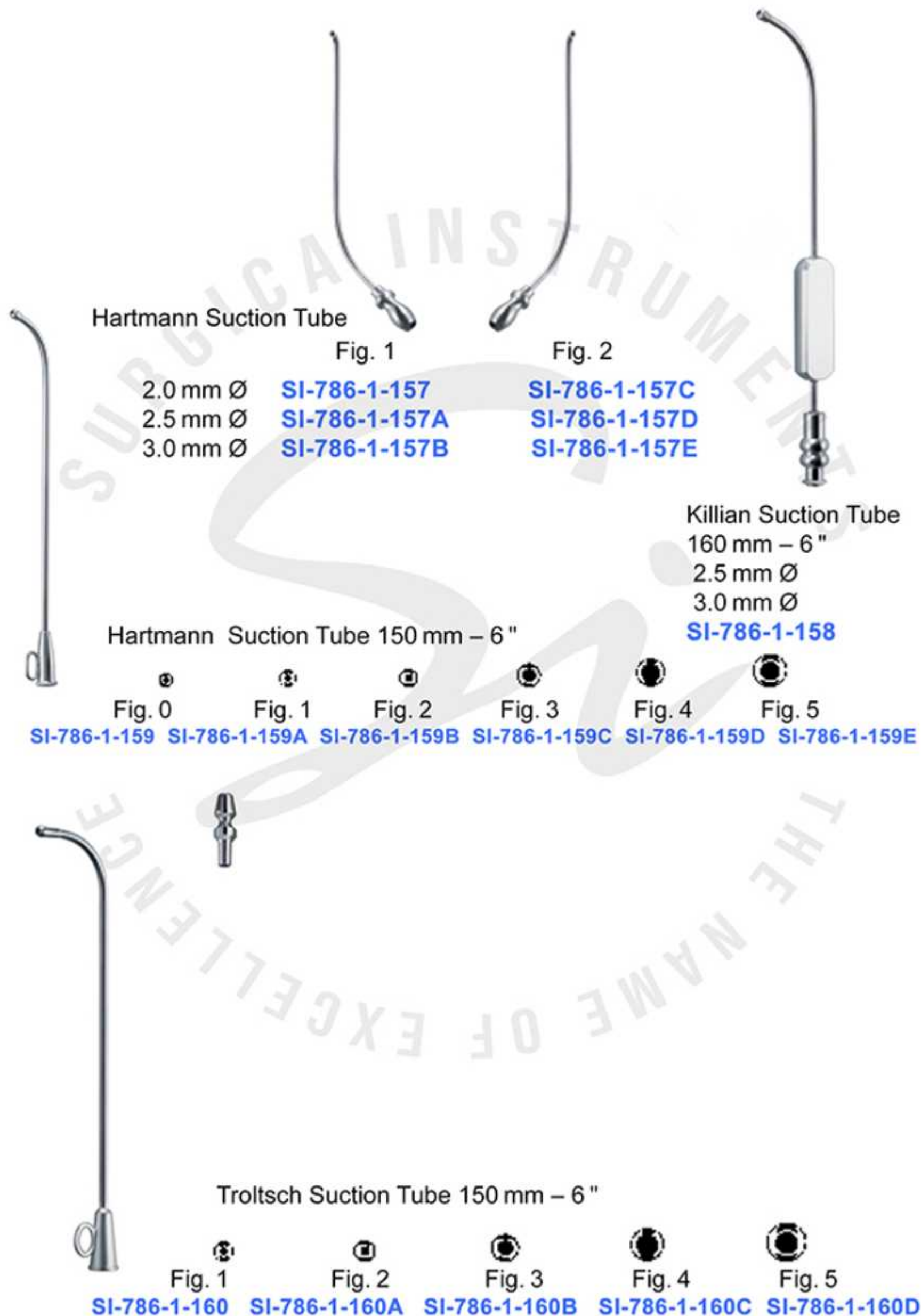

Seringue auriculaire
Ear syringe
Jeringa auricular
Siringhe auricolari



Ear syringe
SI-ES-1-01
50 ccm 2 oz
Complete Set



Ear syringe
SI-ES-1-02
100 ccm 4 oz
Complete Set



Canules pour aspiration et lavage
Suction and irrigation cannulas
Canulas para aspiracion y lavado
Cannule per aspirazione e lavaggio



Suction cannulas
Package of 6 pieces
1.2 mm Ø x 60 mm
SI-786-1-161
1.5 mm Ø x 80 mm
SI-786-1-161A
2.0 mm Ø x 80 mm
SI-786-1-161B

Suction cannulas
Package of 6 pieces
1.2 mm Ø x 60 mm
SI-786-1-162
1.5 mm Ø x 80 mm
SI-786-1-162A
2.0 mm Ø x 80 mm
SI-786-1-162B

Eicken Suction and irrigation cannulas		
slightly curved	strongly curved	malleable
2.5 mm Ø	2.5 mm Ø	2.5 mm Ø
SI-786-1-163	SI-786-1-164	SI-786-1-165
3.0 mm Ø	3.0 mm Ø	3.0 mm Ø
SI-786-1-163A	SI-786-1-164A	SI-786-1-165A



Luer-Lock Suction cannulas
3.0 mm Ø
SI-786-1-166

Fisch Suction cannulas
4 mm Ø
SI-786-1-167

Luer-Lock Suction cannulas
2.5 mm Ø
SI-786-1-168

Canules pour aspiration et lavage
Suction and irrigation cannulas
Canulas para aspiracion y lavado
Cannule per aspirazione e lavaggio

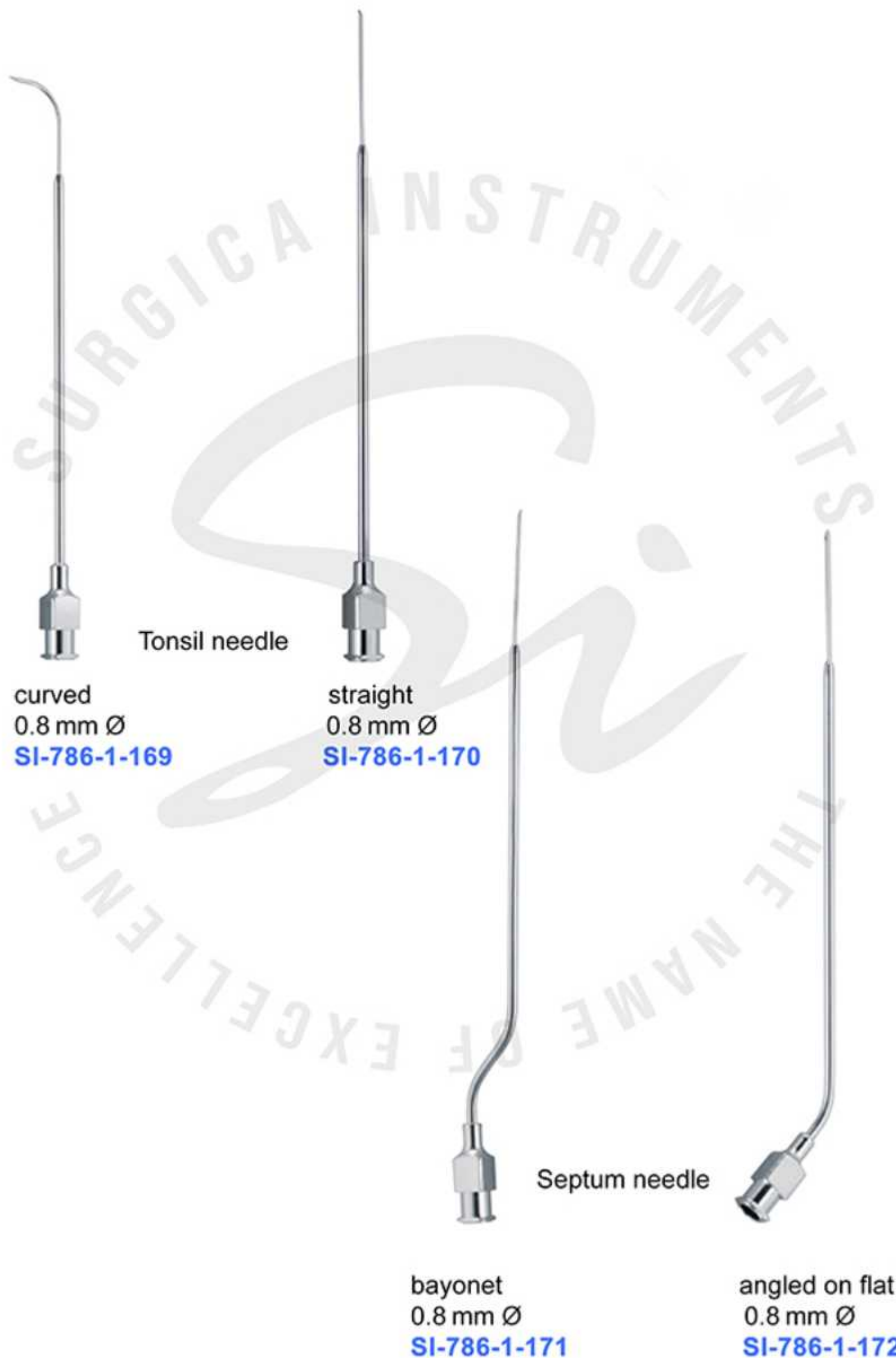

Sondes et stylets
Probes and directors
Sondas y estiletes
Specilli e sonde



BUTTERFLY PROBE

- 115 mm – 4 1/2 " **SI-786-1-173**
- 130 mm – 5 " **SI-786-1-173A**
- 145 mm – 5 3/4 " **SI-786-1-173B**
- 160 mm – 6 1/4 " **SI-786-1-173C**
- 180 mm – 7 " **SI-786-1-173D**
- 200 mm – 8 " **SI-786-1-173E**



BUTTERFLY PROBE

- 115 mm – 4 1/2 " **SI-786-1-174**
- 130 mm – 5 " **SI-786-1-174A**
- 145 mm – 5 3/4 " **SI-786-1-174B**
- 160 mm – 6 1/4 " **SI-786-1-174C**
- 180 mm – 7 " **SI-786-1-174D**
- 200 mm – 8 " **SI-786-1-174E**



Doyen BUtterfly Probe
140 mm–5 1/2 "
SI-786-1-175



Nelaton BUtterfly Probe
160 mm–6 1/2 "
SI-786-1-176



Myrtle Leaf Probe
130 mm – 5 "
SI-786-2-178

Porte-cotons
Cotton applicators
Porta-algodones
Portacotoni



Farrell-Lathbury Cotton applicators

- | | | |
|---------------|---------------|---------------|
| SI-786-1-177 | SI-786-1-178 | SI-786-1-179 |
| SI-786-1-177A | SI-786-1-178A | SI-786-1-179A |
| SI-786-1-177B | SI-786-1-178B | SI-786-1-179B |
| SI-786-1-177C | SI-786-1-178C | SI-786-1-179C |
| SI-786-1-177D | SI-786-1-178D | SI-786-1-179D |

Available Size:

- | | |
|------------------|----------|
| 120 mm – 4 3/4 " | 0.9 mm Ø |
| 140 mm – 5 1/2 " | 0.9 mm Ø |
| 165 mm – 6 1/4 " | 1.1 mm Ø |
| 180 mm – 7 " | 1.2 mm Ø |
| 230 mm – 9 " | 1.3 mm Ø |

- | | |
|--------------|--------------|
| 2.5 mm Ø | 2.5 mm Ø |
| SI-786-1-180 | SI-786-1-181 |

Farrell Cotton applicators 280 mm – 11 "



- | |
|------------------|
| 120 mm – 4 3/4 " |
| 140 mm – 5 1/2 " |
| 160 mm – 6 1/4 " |
| 180 mm – 7 " |

SI-786-1-182

Mod. Martin Cotton applicators

Porte-cotons
Cotton applicators
Porta-algodones
Portacotoni

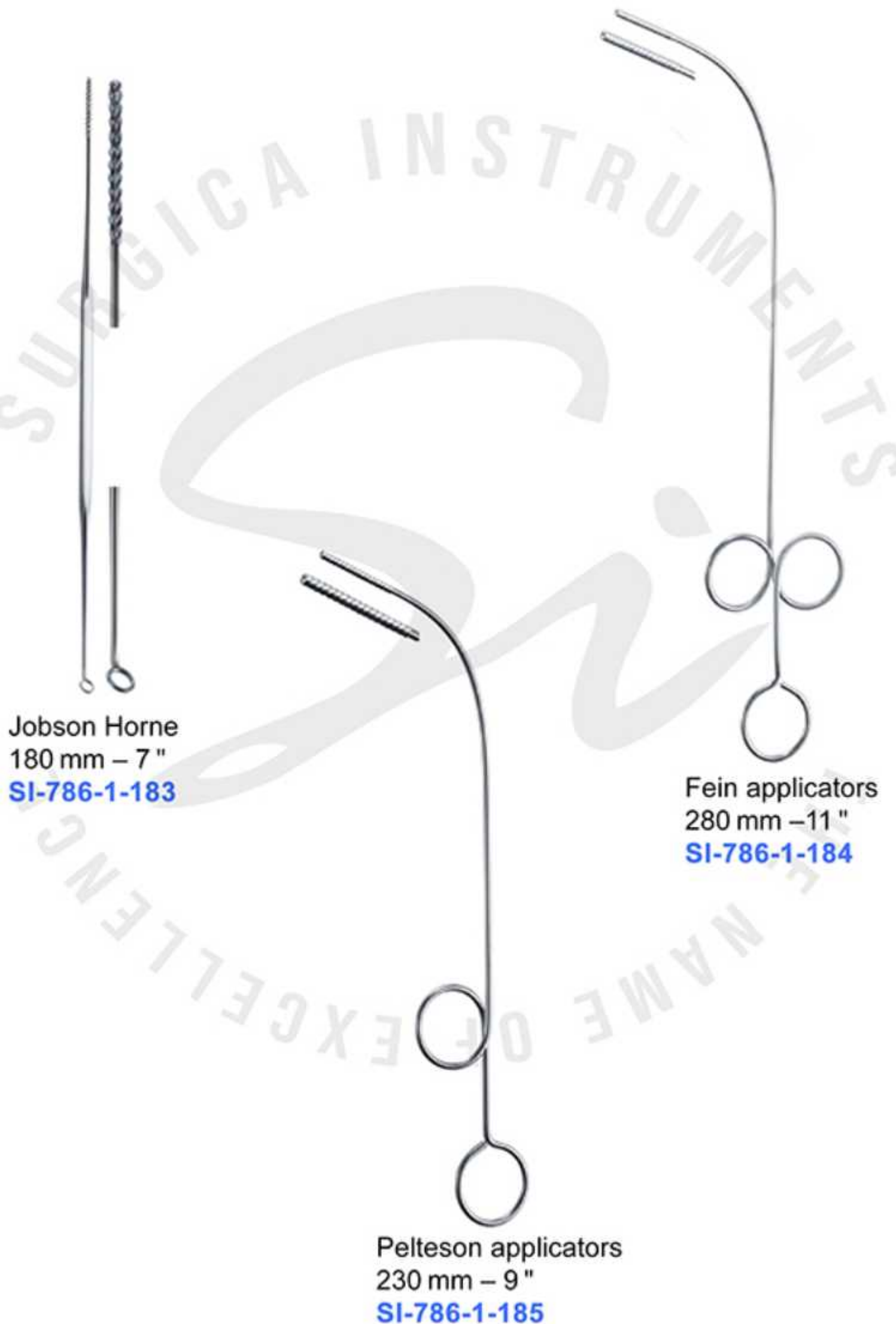

Jobson Horne
180 mm – 7 "
SI-786-1-183

Fein applicators
280 mm – 11 "
SI-786-1-184

Pelteson applicators
230 mm – 9 "
SI-786-1-185

Si **SURGICA**
INSTRUMENTS
THE NAME OF EXCELLENCE



PLASTER INSTRUMENTS



Instruments pour plâtres
Plaster instruments
Instrumentos para vendajes enyesados
Strumenti per apparecchi gessati



Engel Plaster Saw
140 mm – 5 1/2 "
SI-786-4-01



Bergmann Plaster Cast Saw
180 mm – 7 "
SI-786-4-02



Hopkins Plaster Knife
200 mm – 8 "
SI-786-4-03



Esmarch Plaster Knife
180 mm – 7 "
SI-786-4-04



Stille Plaster Shear
230 mm – 9 "
SI-786-4-05
260 mm – 10 1/4 "
SI-786-4-05A
370 mm – 14 1/2 "
SI-786-4-05B

Instruments pour plâtres
Plaster instruments
Instrumentos para vendajes enyesados
Strumenti per apparecchi gessati

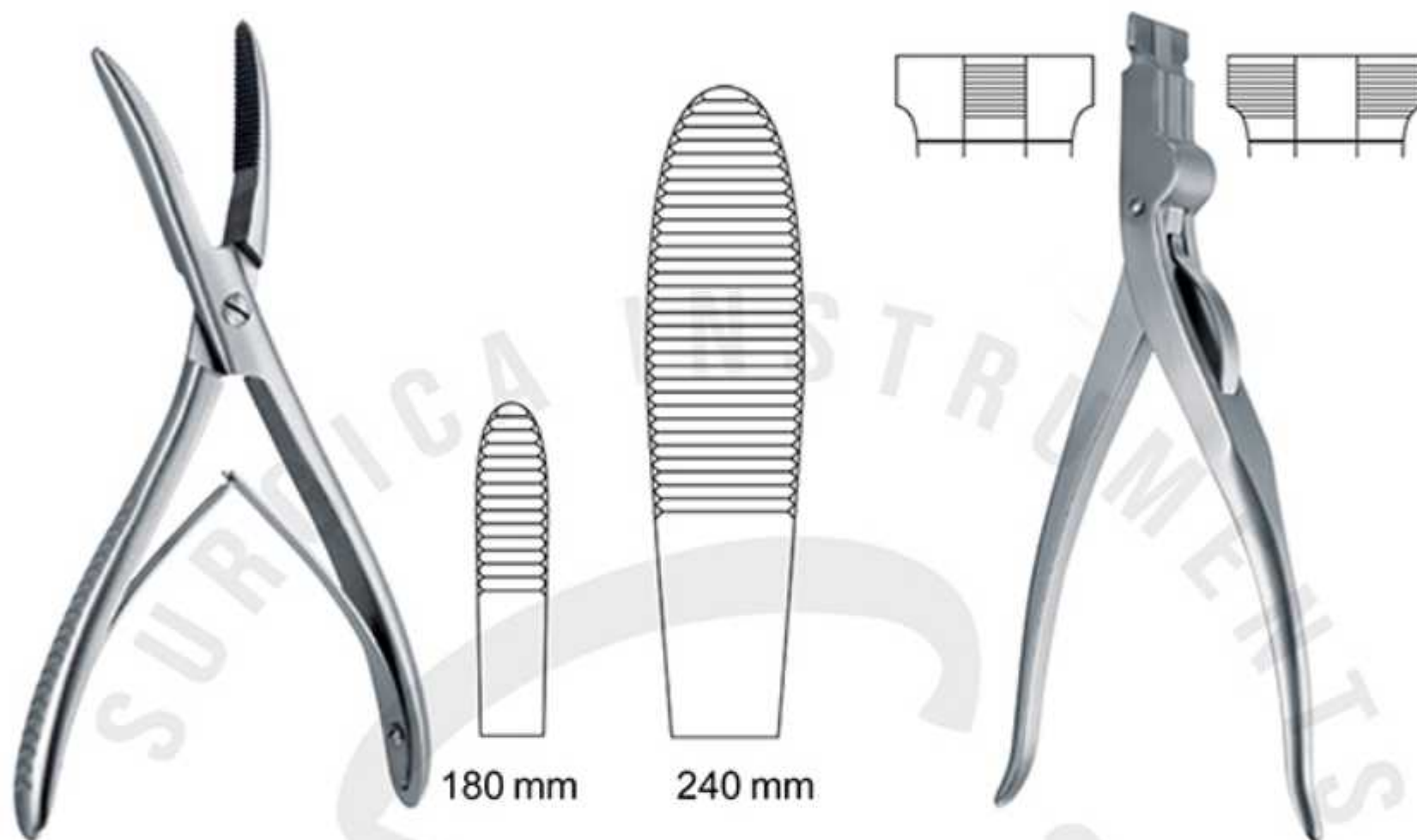

Wolf Boehler Plaster cast Breaker
180 mm – 7 "
SI-786-4-06
240 mm – 9 1/2 "
SI-786-4-06A

USA Model Plaster Spreader
230 mm – 9 "
SI-786-4-07



Beeson Plaster cast Spreader
300 mm – 12 "
SI-786-4-08



Hennig Plaster Spreader
280 mm – 11 "
SI-786-4-09

Si **SURGICA**
INSTRUMENTS
THE NAME OF EXCELLENCE



SCAPELS,KNIVES

- OPERATING KNIVES
- SCALPEL HANDLES
- AUTOPSY KNIVES
- RSECTION KNIVES
- TRANSPLANTATION KNIVES

Bistouris pour opérations
Operating knives
Bisturías para operaciones
Bisturi per operazioni



Fig. 1 Fig. 2

Dieffenbach Operating knives
160 mm – 6 1/4 "

Fig. 1
SI-786-2-101

Fig. 2
SI-786-2-101A



Fig. 1 Fig. 2 Fig. 3 Fig. 4 Fig. 5



Fig. 6 Fig. 7 Fig. 8 Fig. 9 Fig. 10

Operating knives
160 mm – 6 1/4 "
SI-786-2-102

Manches pour bistouri
Scalpel handles
Mangos de bisturi
Manici per bisturi



Standard Scalpel handles
Fig. 4
SI-786-2-103
Fig. 4 L
SI-786-2-103A



Collin Scalpel handles
Hollow
Fig. 8
SI-786-2-104



Scalpel handles
Fig. 3
SI-786-2-105



Scalpel handles
Fig. 7K
SI-786-2-106



Scalpel handles
Fig. 7
SI-786-2-107



Scalpel handles
Fig. 3 grad
SI-786-2-108



Scalpel handles
Fig. 3 R
SI-786-2-109



Scalpel handles
Fig. 3 RG
SI-786-2-110

Couteaux à dissection
Autopsy knives
Cuchillos para autopsía
Coltelli per autopsia



Virchow Autopsy knives
x = 120 mm – 4 "
255 mm – 10"
SI-786-2-111



Virchow Autopsy knives
x=80 mm – 3 1/2 "
255 mm – 10"
SI-786-2-112

Autopsy knives with wooden handle



Walb Post mortem knives
260 mm – 10 1/4 "
x=110 mm – 4 1/4 "
SI-786-2-113
290 mm – 11 1/2 "
x=140 mm – 5 1/2 "
SI-786-2-113A
310 mm – 12 1/4 "
x=170 mm – 6 3/4 "
SI-786-2-113B

Virchow Brain knives with metal handle
260 mm – 10 1/4 "
x=160 mm – 6 1/4 "
SI-786-2-114
335 mm – 13 1/4 "
x=200 mm – 8 "
SI-786-2-114A
380 mm – 15 "
x=240 mm – 9 1/2 "
SI-786-2-114B



Couteaux à amputation – Couteaux à résection
Amputation knives – Resection knives
Cuchillos para amputación – Cuchillos para resección
Coltelli per amputazione – Coltelli per resezione



Collin Resection knives

x = 130 mm **SI-786-2-115**
x = 160 mm **SI-786-2-115A**
x = 190 mm **SI-786-2-115B**
x = 220 mm **SI-786-2-115C**
Double cutting edge



Catlin Resection knives

x = 160 mm
290 mm – 11 1/2 "
SI-786-2-116
Double cutting edge



Langenbeck Resection knives

x = 55 mm
SI-786-2-117



Langenbeck Resection knives
x = 55 mm
SI-786-2-118



Langenbeck Resection knives
x = 120 mm
SI-786-2-119

Dermatomes – Bistouries pour transplantation
 Dermatomes – Transplantation knives
 Dermatomes – Cuchillos para trasplantaciones
 Dermatomi – Coltello per trapianto



Thiersch Skin Graft Knife
 200 mm – 8 "
SI-786-2-120



Schink Dermatome Skin Graft Knife
 300 mm – 12 "
SI-786-2-121
 Complete with 1 blade and 2 plates



Schink Dermatome Skin Graft Blade
SI-786-2-122



Schink Dermatome Skin Graft Plate
SI-786-2-123

Dermatomes
Dermatomes
Dermatomos
Dermatomi



Humby Dermatome Skin Graft Knife
310 m – 12 1/4 "
SI-786-2-124
Complete with 1 blade

Humby Dermatome Skin Graft Blade
SI-786-2-125



Watson Dermatome Skin Graft Knife
300 mm – 12 "
SI-786-2-126
Complete with 1 blade, fixed bar

Silver Skin Graft Dermatome
190mm – 7 1/2 "
SI-786-2-127



S*i* SURGICA
INSTRUMENTS
THE NAME OF EXCELLENCE



SCHEREN, SCISSORS

- OPERATING SCISSORS
- DISSECTING SCISSORS
- GYNAECOLOGICAL SCISSORS
- FINE OPERATING SCISSORS
- FISTULA AND ENUCLEATION SCISSORS
- ARTERY SCISSORS
- CARTILAGE SCISSORS
- TONSIL SCISSORS



Ciseaux à chirurgie
Operating scissors
Tijeras para cirugía
Forbici per chirurgia



Standard



Fig. 1



Fig. 2



Fig. 3

Straight

105 mm – 4 1/4 "
115 mm – 4 1/2 "
130 mm – 5 "
145 mm – 5 3/4 "
155 mm – 6 "
175 mm – 7 "
185 mm – 7 1/4 "
200 mm – 8 "

Fig. 1

SI-S-45-01
SI-S-45-01A
SI-S-45-01B
SI-S-45-01C
SI-S-45-01D
SI-S-45-01E
SI-S-45-01F
SI-S-45-01G

Fig. 2

SI-S-45-02
SI-S-45-02A
SI-S-45-02B
SI-S-45-02C
SI-S-45-02D
SI-S-45-02E
SI-S-45-02F
SI-S-45-02G

Fig. 3

SI-S-45-03
SI-S-45-03A
SI-S-45-03B
SI-S-45-03C
SI-S-45-03D
SI-S-45-03E
SI-S-45-03F
SI-S-45-03G



Standard



Fig. 1



Fig. 2



Fig. 3

Curved

115 mm – 4 1/2 "
130 mm – 5 "
145 mm – 5 3/4 "
155 mm – 6 "
175 mm – 7 "
185 mm – 7 1/4 "
200 mm – 8 "

Fig. 1

SI-S-45-04
SI-S-45-04A
SI-S-45-04B
SI-S-45-04C
SI-S-45-04D
SI-S-45-04E
SI-S-45-04F

Fig. 2

SI-S-45-05
SI-S-45-05A
SI-S-45-05B
SI-S-45-05C
SI-S-45-05D
SI-S-45-05E
SI-S-45-05F

Fig. 3

SI-S-45-06
SI-S-45-06A
SI-S-45-06B
SI-S-45-06C
SI-S-45-06D
SI-S-45-06E
SI-S-45-06F

Ciseaux à chirurgie
Operating scissors
Tijeras para cirugía
Forbici per chirurgia



Grazil
Straight
130 mm – 5 "
145 mm – 5 3/4 "



Fig. 1



Fig. 2



Fig. 3

Fig. 1
SI-S-45-07
SI-S-45-07A

Fig. 2
SI-S-45-08
SI-S-45-08A

Fig. 3
SI-S-45-09
SI-S-45-09A



Grazil
Curved
130 mm – 5 "
145 mm – 5 3/4 "



Fig. 1



Fig. 2



Fig. 3

Fig. 1
SI-S-45-10
SI-S-45-10A

Fig. 2
SI-S-45-11
SI-S-45-11A

Fig. 3
SI-S-45-12
SI-S-45-12A

Ciseaux à chirurgie
Operating scissors
Tijeras para cirugía
Forbici per chirurgia



Deaver
145 mm – 5 3/4 "



SI-S-45-13
Straight



SI-S-45-14
Curved



SI-S-45-15
Straight
Saw edge



SI-S-45-16
Curved
Saw edge



Lange
145 mm – 5 3/4 "



SI-S-45-17
Straight



SI-S-45-18
Curved



SI-S-45-19
Straight
Saw edge



SI-S-45-20
Curved
Saw edge

Ciseaux à chirurgie
Operating scissors
Tijeras para cirugía
Forbici per chirurgia



Mixer
155 mm – 6"



SI-S-45-21
Straight



SI-S-45-22
Curved



Lexer
160 mm – 6 1/4 "
210 mm – 8 1/4 "



SI-S-45-23
160 mm – 6 1/4 "

SI-S-45-24
210 mm – 8 1/4 "

Straight



SI-S-45-23A
160 mm – 6 1/4 "

SI-S-45-24A
210 mm – 8 1/4 "

Curved

Ciseaux à chirurgie
Operating scissors
Tijeras para cirugía
Forbici per chirurgia



Richter
140 mm – 5 1/2 "
SI-S-45-25



Fergusson
140 mm – 5 1/2 " **SI-S-45-26**
160 mm – 6 1/4 " **SI-S-45-26A**
180 mm – 7 " **SI-S-45-26B**



Operating Scissor
130 mm – 5 " **SI-S-45-27**
145 mm – 5 3/4 " **SI-S-45-27A**

Ciseaux à dissection
Dissecting scissors
Tijeras de disección
Forbici per dissezione



Mayo Scissor
145 mm – 5 3/4 "
150 mm – 6 "
170 mm – 6 3/4 "
230 mm – 9 "



Straight
SI-S-45-28
SI-S-45-28A
SI-S-45-28B
SI-S-45-28C

Curved
SI-S-45-29
SI-S-45-29A
SI-S-45-29B
SI-S-45-29C



Mayo-Stillie
150 mm – 6 "
170 mm – 6 3/4 "
195 mm – 7 3/4 "
210 mm – 8 3/4 "



Straight
SI-S-45-30
SI-S-45-30A
SI-S-45-30B
SI-S-45-30C

Curved
SI-S-45-31
SI-S-45-31A
SI-S-45-31B
SI-S-45-31C

Ciseaux à dissection
Dissecting scissors
Tijeras de disección
Forbici per dissezione



Mayo-Harrington
220 mm – 8 3/4 "



Straight
SI-S-45-32



Curved
SI-S-45-33



Straight
SI-S-45-34



Curved
SI-S-45-35



Mayo-Noble
170 mm – 6 3/4 "

Ciseaux à dissection
Dissecting scissors
Tijeras de disección
Forbici per dissezione



Wertheim
145 mm – 5 3/4 "
225 mm – 8 3/4 "

SI-S-45-36
SI-S-45-36A



Metzenbaum
150 mm – 6"



Straight
SI-S-45-37



Curved
SI-S-45-38



Metzenbaum

115 mm – 4 1/2 "
145 mm – 5 3/4 "



Fig. 1



Fig. 2



Fig. 3

Fig. 1
SI-S-45-39
SI-S-45-39A

Fig. 2
SI-S-45-40
SI-S-45-40A

Fig. 3
SI-S-45-41
SI-S-45-41A

Ciseaux à dissection
Dissecting scissors
Tijeras de disección
Forbici per dissezione



Metzenbaum



Fig. 1



Fig. 2



Fig. 3

Curved
115 mm – 4 1/2 "
145 mm – 5 3/4 "

Fig. 1
SI-S-45-42
SI-S-45-42A

Fig. 2
SI-S-45-43
SI-S-45-43A

Fig. 3
SI-S-45-44
SI-S-45-44A



Metzenbaum-Nelson



Fig. 1



Fig. 2



Fig. 3

Straight
180 mm – 7 "
200 mm – 8 "
230 mm – 9 "
250 mm – 9 3/4 "
280 mm – 11 "
300 mm – 12 "

Fig. 1
SI-S-45-45
SI-S-45-45A
SI-S-45-45B
SI-S-45-45C
SI-S-45-45D
SI-S-45-45E

Fig. 2
SI-S-45-46
SI-S-45-46A
SI-S-45-46B
SI-S-45-46C
SI-S-45-46D
SI-S-45-46E

Fig. 3
SI-S-45-47
SI-S-45-47A
SI-S-45-47B
SI-S-45-47C
SI-S-45-47D
SI-S-45-47E

Ciseaux à dissection
Dissecting scissors
Tijeras de disección
Forbici per dissezione



Fig. 1



Fig. 2



Fig. 3

Metzenbaum-Nelson

Curved

- 180 mm – 7 "
- 200 mm – 8 "
- 230 mm – 9 "
- 250 mm – 9 3/4 "
- 280 mm – 11 "
- 300 mm – 12 "

Fig. 1

- SI-S-45-48
- SI-S-45-48A
- SI-S-45-48B
- SI-S-45-48C
- SI-S-45-48D
- SI-S-45-48E

Fig. 2

- SI-S-45-49
- SI-S-45-49A
- SI-S-45-49B
- SI-S-45-49C
- SI-S-45-49D
- SI-S-45-49E

Fig. 3

- SI-S-45-50
- SI-S-45-50A
- SI-S-45-50B
- SI-S-45-50C
- SI-S-45-50D
- SI-S-45-50E



Fig. 1

SI-S-45-51



Fig. 3

SI-S-45-52



Fig. 1

SI-S-45-53



Fig. 3

SI-S-45-54

Metzenbaum-Fino
145 mm – 5 3/4 "

Ciseaux à dissection
Dissecting scissors
Tijeras de disección
Forbici per dissezione



Metzenbaum-Fino



Straight



Curved



S-Curved

	Straight	Curved	S-Curved
180 mm – 7 "	SI-S-45-55	SI-S-45-56	SI-S-45-57
200 mm – 7¾ "	SI-S-45-55A	SI-S-45-56A	SI-S-45-57A
230 mm – 9 "	SI-S-45-55B	SI-S-45-56B	SI-S-45-57B



Fomon
135 mm – 5 1/4 "
SI-S-45-58



Thorek
190 mm – 7 1/2 "
SI-S-45-59

Ciseaux à gynécologie
Gynaecological scissors
Tijeras para ginecología
Forbici per ginecologia



Fig. 1



Fig. 2



Fig. 1



Fig. 2

Sims
200 mm – 8"
230 mm – 9"

Fig. 1
SI-S-45-60
SI-S-45-60A

Fig. 2
SI-S-45-61
SI-S-45-61A

Fig. 1
SI-S-45-62
SI-S-45-62A

Fig. 2
SI-S-45-63
SI-S-45-63A



Straight
SI-S-45-66



Curved
SI-S-45-67

Doyen
175 mm – 7"

Ciseaux à gynécologie
Gynaecological scissors
Tijeras para ginecología
Forbici per ginecologia



Dubois
270 mm – 10 3/4 "



Straight
SI-S-45-64



Curved
SI-S-45-65



Siebold
240 mm – 9 1/2 "
SI-S-45-68
S-curved

Ciseaux fins à chirurgie
Fine operating scissors
Tijeras finas para cirugía
Forbici fine per chirurgia



Fine Operating Scissor



Fig. 1



Fig. 2



Fig. 3

Straight
120 mm – 4 3/4 "

Fig. 1
SI-S-45-69

Fig. 2
SI-S-45-70

Fig. 3
SI-S-45-71



Fine Operating Scissor



Fig. 1



Fig. 2



Fig. 3

Curved
120 mm – 4 3/4 "

Fig. 1
SI-S-45-72

Fig. 2
SI-S-45-73

Fig. 3
SI-S-45-74

Ciseaux fins à chirurgie
Fine operating scissors
Tijeras finas para cirugía
Forbici fine per chirurgia



Knapp
105 mm – 4 1/4 "
blunt



Straight
SI-S-45-75



Curved
SI-S-45-75A



Wagner
120 mm – 4 3/4 "



Straight
SI-S-45-76



Curved
SI-S-45-77



Brophy (Sullivan)
145 mm – 5 3/4 "



Straight
SI-S-45-78



Curved
SI-S-45-79



Littler
115 mm – 4 1/2 "
145 mm – 5 3/4 "



SI-S-45-80

SI-S-45-80A

Ciseaux fins à chirurgie
Fine operating scissors
Tijeras finas para cirugía
Forbici fine per chirurgia



Locklin
165 mm – 6 1/2 "
SI-S-45-81
Saw edge



Locklin
165 mm – 6 1/2 "
SI-S-45-82
Saw edge



Quinby
125 mm – 5 "
SI-S-45-83



Neumann
120 mm – 4 3/4 "
SI-S-45-86
S-curved

Ciseaux fins à chirurgie
Fine operating scissors
Tijeras finas para cirugía
Forbici fine per chirurgia



Reynolds
160 mm – 6 1/4 " **SI-S-45-84**
180 mm – 7 " **SI-S-45-84A**



Reynolds
160 mm – 6 1/4 " **SI-S-45-85**
180 mm – 7 " **SI-S-45-85A**



Fine scissors
105 mm – 4 1/4 "



Fine scissors
110 mm – 4 1/4 "



Ciseaux fins à chirurgie
Fine operating scissors
Tijeras finas para cirugía
Forbici fine per chirurgia



Fine scissor
90 mm – 3 1/2 "



Straight
SI-S-45-91



Curved
SI-S-45-92



Fine scissor
90 mm – 3/4 "
100 mm – 4 "
115 mm – 4 1/2 "



Straight

Straight
SI-S-45-93
SI-S-45-93A
SI-S-45-93B



Curved

Curved
SI-S-45-94
SI-S-45-94A
SI-S-45-94B



Sanvenero
145 mm – 5 3/4 "



Straight
SI-S-45-95



Curved
SI-S-45-96



Lexer-Baby
100 mm – 4 "



Straight
SI-S-45-97



Curved
SI-S-45-98

Ciseaux pour fistules
Fistula scissors
Tijeras para fistulas
Forbici per fistole



Kelly

160 mm – 6 1/4 "
180 mm – 7 "



Straight



Curved

Straight

SI-S-45-99

SI-S-45-99A

Curved

SI-S-45-100

SI-S-45-100A



Enucleation scissors
110 mm – 4 1/4 "

SI-S-45-103



Landoldt
125 mm – 5 "



Straight

SI-S-45-101



Curved

SI-S-45-102



Chadwick
110 mm – 4 1/4 "

SI-S-45-104

Ciseaux artériels
Artery scissors
Arterienschere
tijeras de arteria



Artery scissor
145 mm – 5 3/4 "
SI-S-45-105
1 Blade with Probe



Lincoln
170 mm – 6 3/4 "



Straight
SI-S-45-106



Curved
SI-S-45-107



Artery scissor
115 mm – 4 1/2 "
SI-S-45-108



Fulton
170 mm – 6 3/4 "
SI-S-45-109



Potts-Smith
de Martel
195 mm – 7 3/4 "
SI-S-45-110

Ciseaux artériels
Artery scissors
Arterienschere
tijeras de arteria



Favaloro
150 mm – 6 "
SI-S-45-111



Mills
225 mm – 8 3/4 "
SI-S-45-114



De Bakey
155 mm – 6 "
Offset scissors, s-shaped

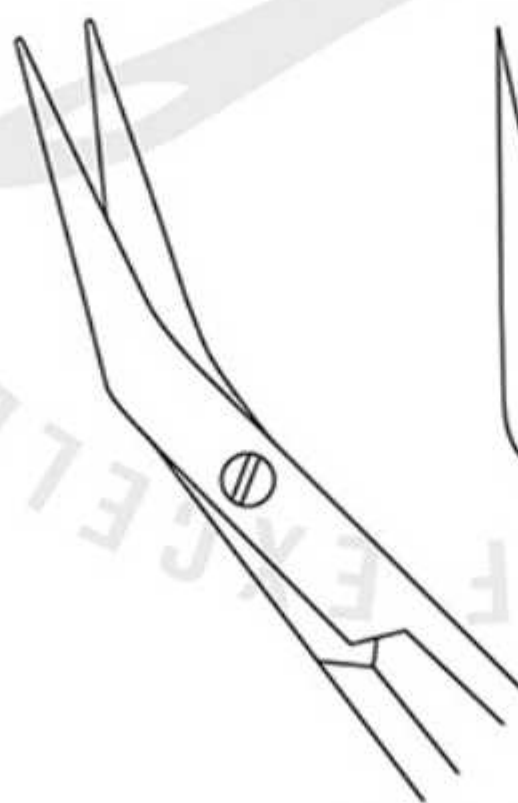

SI-S-45-112

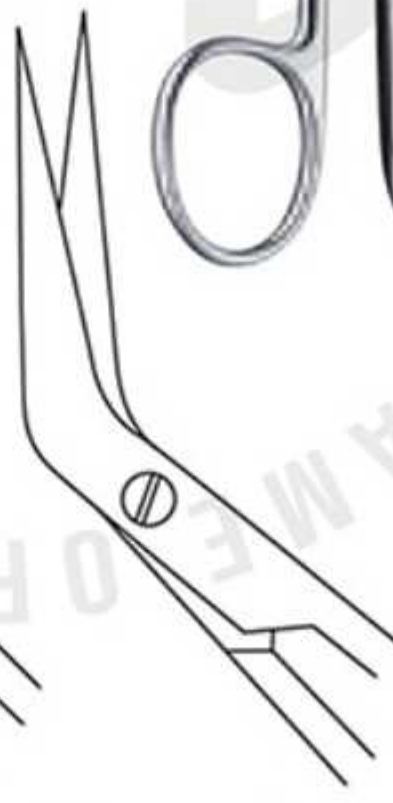

SI-S-45-112A

Ciseaux artériels
Artery scissors
Arterienschere
tijeras de arteria



De Bakey
160 mm
230 mm
280 mm



25°

SI-S-45-113

SI-S-45-113C

SI-S-45-113F

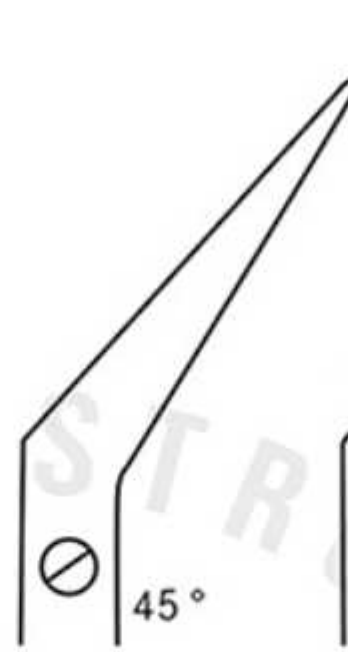

45°

SI-S-45-113A

SI-S-45-113D

SI-S-45-113G

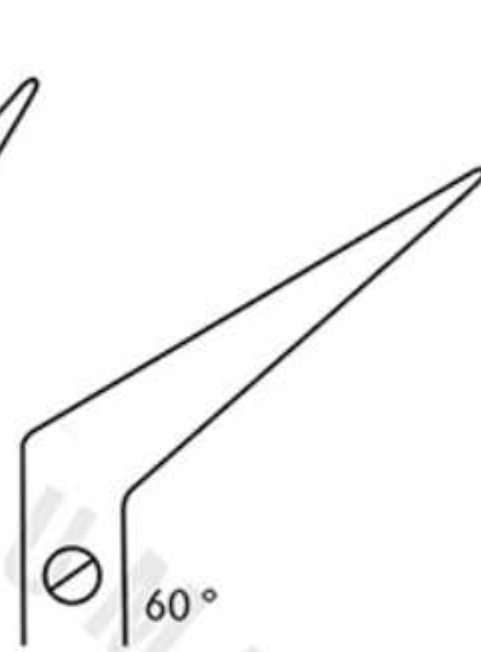

60°

SI-S-45-113B

SI-S-45-113E

SI-S-45-113H



Potts-de
Martel
190 mm m – 7 1/2 "



25°

SI-S-45-115

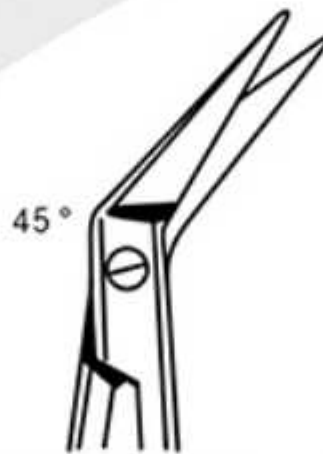

45°

SI-S-45-115A



60°

SI-S-45-115B



125°

SI-S-45-115C

Ciseaux artériels
Artery scissors
Arterienschere
tijeras de arteria



Micro Scissor
180 mm – 7 "

25°



SI-S-45-116

45°



SI-S-45-116A

60°



SI-S-45-116B

90°

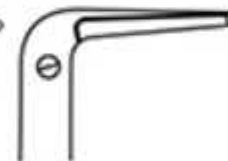

SI-S-45-116C

125°



SI-S-45-116D

25°



SI-S-45-116E

45°



SI-S-45-116F

60°



SI-S-45-116G

90°



SI-S-45-116H

125°



SI-S-45-116I

Ciseaux artériels
Artery scissors
Arterienschere
tijeras de arteria

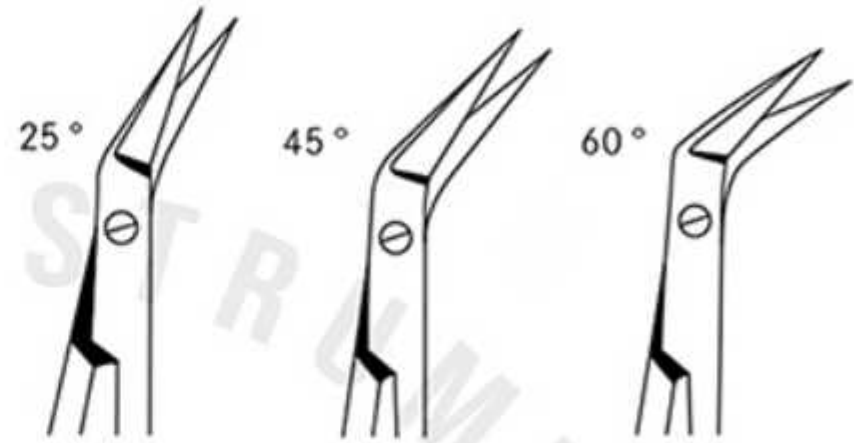

SI-S-45-117
SI-S-45-117C
SI-S-45-117F

SI-S-45-117A
SI-S-45-117D
SI-S-45-117G

SI-S-45-117B
SI-S-45-117E
SI-S-45-117H

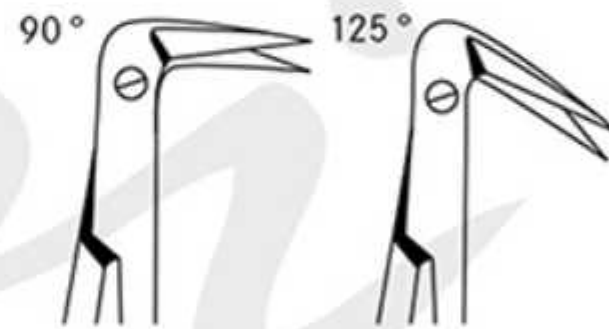

SI-S-45-117I
SI-S-45-117K
SI-S-45-117M

SI-S-45-117J
SI-S-45-117L
SI-S-45-117N

Diethrich-Hegemann
145 mm – 5 3/4 "
160 mm – 6 1/4 "
190 mm – 7 1/2 "

Ciseaux à cartilage
Cartilage scissors
Knorpelschere
Tijeras de cartílago



Martin-Cartilage
190 mm – 7 1/2 "
SI-S-45-118
Curved, saw edge



Potts-Smith
190 mm – 7 1/2 "
SI-S-45-120



Mc Indoe
190 mm – 7 1/2 "
SI-S-45-119

Ciseaux pour amygdales
Tonsil scissors
Tijeras para amigdales
Forbici per tonsille



Boettcher
180 mm – 7 "
SI-S-45-121



Toennis-Adson
170 mm – 6 3/4 "
SI-S-45-123



Prince
175 mm – 7 "
SI-S-45-122



Toennis
180 mm – 7 "



Straight
SI-S-45-124



Curved
SI-S-45-125

Ciseaux pour amygdales
Tonsil scissors
Tijeras para amigdales
Forbici per tonsille



Dean
170 cm – 6 3/4 "
SI-S-45-126
Curved



Wertheim
190 mm – 7 1/2 "
SI-S-45-127



Olivecrona
230 mm – 9 "
SI-S-45-128
Trigeminal scissors



Good
190 mm – 7 1/2 "
SI-S-45-129

Ciseaux à lobectomie
Lobectomy scissors
Tijeras para lobectomia
Forbici per lobectomia



Crafoord
300 mm – 12 "
SI-S-45-130

Willauer
250 mm – 9 3/4 "
280 mm – 11 "



Finochietto
270 mm – 10 3/4 "
SI-S-45-132



Straight
SI-S-45-131
SI-S-45-131B

Curved
SI-S-45-131A
SI-S-45-131C



Resano
250 mm – 10 "
SI-S-45-133

Ciseaux pour le thorax
Thorax scissors
Tijeras para torax
Forbici per torace



Satinsky
245 mm – 9 3/4"
SI-S-45-134



Klinkenberg-Loth
230 mm – 9"
SI-S-45-135



Jorgenson
220 mm – 8 3/4"
SI-S-45-136

Ciseaux pour l'intestin
Enterotomy scissors
Tijeras para intestino
Forbici per enterotomia



Enterotomy Scissors
210 mm – 8 1/4 "
Fig. 1
SI-S-45-137



Enterotomy Scissors
210 mm – 8 1/4 "
Fig. 2
SI-S-45-138



Enterotomy Scissors
210 mm – 8 1/4 "
Fig. 3
SI-S-45-139

Ciseaux pour le cordon ombilical
Umbilical scissors
Tijeras umbilicales
Forbici ombelicali



Busch
130 mm – 5 "
160 mm – 6 1/4 "
Saw edge

SI-S-45-140
SI-S-45-140A



Schumacher
160 mm – 6 1/4 "
SI-S-45-141



Mod. USA
105 mm – 4 1/4 "
SI-S-45-142

Ciseaux à épisiotomie
Episiotomy scissors
Tijeras para episiotomia
Forbici per episiotomia



Braun-Stadler
145 mm – 5 3/4 " **SI-S-45-143**
220 mm – 8 3/4 " **SI-S-45-143A**



Waldmann
180 mm – 7 " **SI-S-45-144**

Parametrium ciseaux
Parametrium scissors
Parametrium tijeras
Forbici per il parametrio

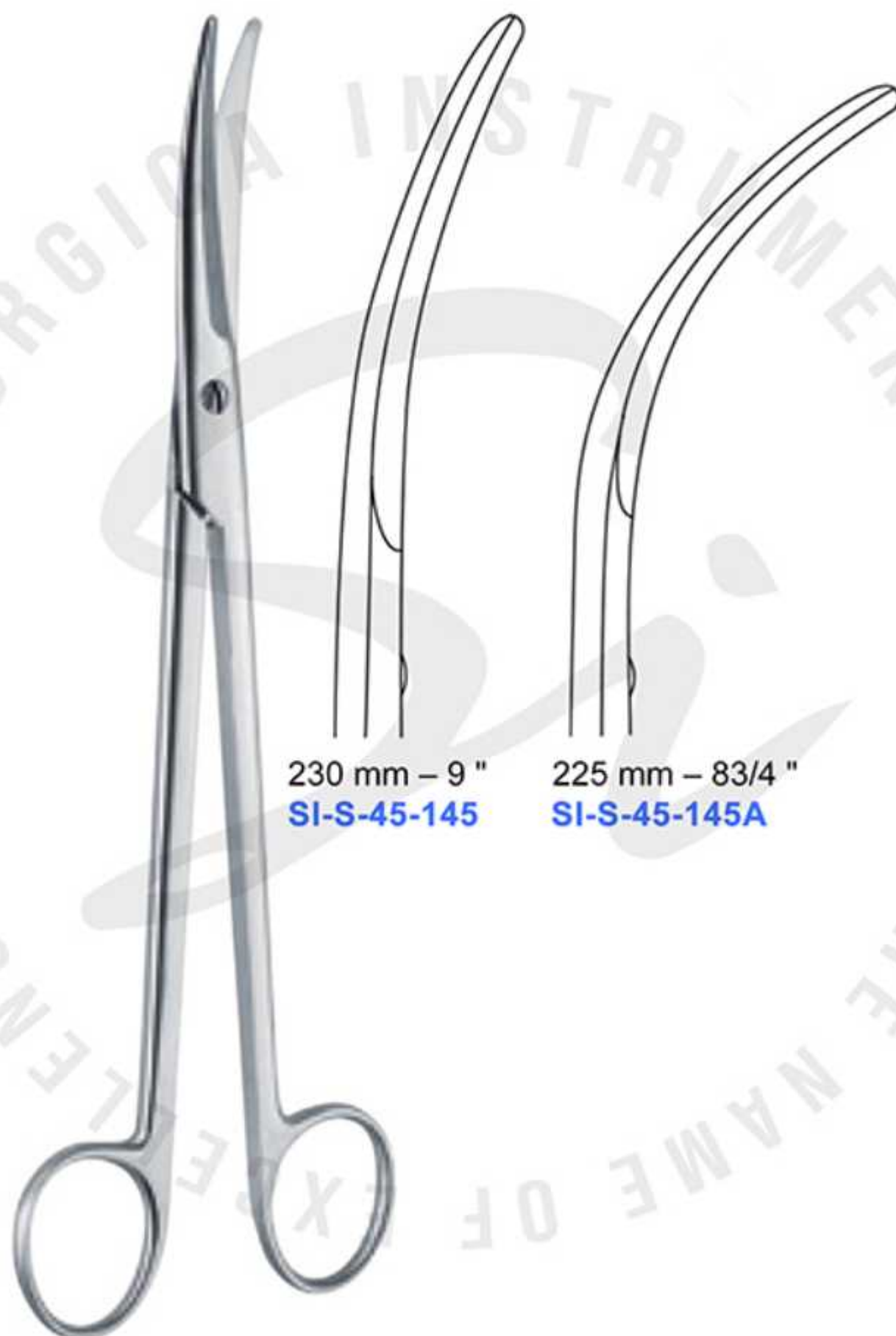

Parametrium scissors

Ciseaux nasaux
Nasal scissors
Tijeras nasales
Forbici nasali



Sailer
170 mm – 6 3/4 "
SI-S-45-146



Heymann
180 mm – 7 "
SI-S-45-147



Fomon
130 mm – 5 "
SI-S-45-148



Cottle
160 mm – 6 1/4 "
SI-S-45-149

Ciseaux à iridectomie
Iris scissors
Tijeras para iridectomia
Forbici per iridectomia



Iris scissors
120 mm – 4 3/4 "



Straight **SI-S-45-150** Curved **SI-S-45-151**



Iris scissors
115 mm – 4 1/2 "



Straight **SI-S-45-152** Curved **SI-S-45-153** Angular **SI-S-45-154** Laterally curved **SI-S-45-155**

Ciseaux à ténatomie
Tenotomy scissors
Tijeras para tenotomia
Forbici per tenotomia



Walton
100 mm – 4"
SI-S-45-158



Stevens
100 mm – 4 "
110 mm – 4 1/4 "
Sharp – Sharp



Straight	Curved
SI-S-45-156	SI-S-45-156A
SI-S-45-156B	SI-S-45-156C



Graefe
95 mm – 3 3/4"
SI-S-45-159



Stevens
100 mm – 4 "
110 mm – 4 1/4 "
Blunt – Blunt



Straight	Curved
SI-S-45-157	SI-S-45-157A
SI-S-45-157B	SI-S-45-157C

Ciseaux à strabisme
Strabismus scissors
Tijeras para estrabismo
Forbici per strabismo



Strabismus
115 mm – 4 1/2 "



Straight
SI-S-45-160



Curved
SI-S-45-161



Strabismus
115 mm – 4 1/2 "



Straight
SI-S-45-162



Curved
SI-S-45-163



Anatomy Scissors
Curved
115 mm – 4 1/2 "
130 mm – 5 "
140 mm – 5 1/2 "

SI-S-45-165
SI-S-45-165A
SI-S-45-165B



Anatomy Scissors
Straight
115 mm – 4 1/2 "
130 mm – 5 "
140 mm – 5 1/2 "

SI-S-45-164
SI-S-45-164A
SI-S-45-164B



Taylor
145 mm – 5 3/4 "
SI-S-45-166

Ciseaux à strabisme
Strabismus scissors
Tijeras para estrabismo
Forbici per strabismo



Schmieden
170 mm – 6 3/4 "
SI-S-45-167



Strully
220 mm – 8 3/4 "



SI-S-45-169

SI-S-45-170



Dandy
170 mm – 6 3/4 "
SI-S-45-168

Ciseaux à ligatures
Ligature scissors
Tijeras para ligaduras
Forbici per sutura



Littauer
140 mm – 5 1/2 "
SI-S-45-171



O'Brien
90 mm – 3 1/2 "
SI-S-45-172



Ligature Scissors
115 mm – 4 1/2 "
SI-S-45-174



Spencer
90 mm – 3 1/2 " **SI-S-45-173**
105 mm – 4 1/4 " **SI-S-45-173A**
130 mm – 5 " **SI-S-45-173B**



Buck
145 mm – 5 3/4 " **SI-S-45-175**
180 mm – 7 " **SI-S-45-175A**

Ciseaux à ligatures
Ligature scissors
Tijeras para ligaduras
Forbici per sutura



Northbent
90 mm – 3 1/2 " **SI-S-45-176**
125 mm – 5 " **SI-S-45-176A**



Heath
150 mm – 6 " **SI-S-45-177**
Saw edge



Ligature Scissor
120 mm – 4 3/4 " **SI-S-45-178**
Saw edge



Eiselsberg
110 mm – 4 1/4 " **SI-S-45-179**



Ligature Scissor
105 mm – 4 1/4 " **SI-S-45-180**

Cisailles pour fils
Wire cutting scissors
Cizallas para cortar alambre
Forbici per filo metallico



Universal
120 mm – 4 3/4 "
SI-S-45-181
Saw edge



Harvey
125 mm – 5 "
SI-S-45-182
Saw edge



Schuhknecht
125 mm – 5 "
SI-S-45-183
Saw edge

Cisailles pour fils
Wire cutting scissors
Cizallas para cortar alambre
Forbici per filo metallico

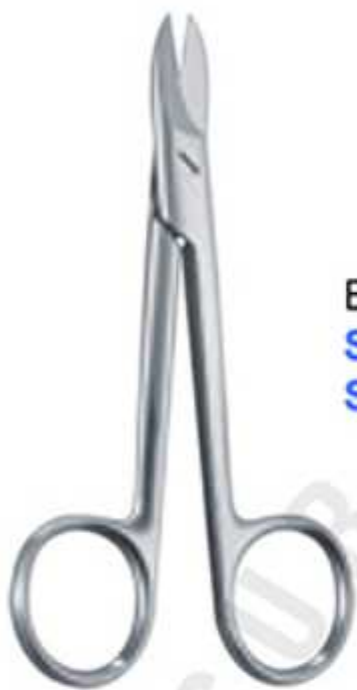

Beebee
100 mm – 4 "
120 mm – 4 3/4 "
Straight, saw edge for
Soft wire up to ø 0.8 mm



Blunt – Blunt
SI-S-45-184
SI-S-45-184D



Sharp – Sharp
SI-S-45-184A
SI-S-45-184E



Blunt – Blunt, Saw edge
SI-S-45-184B
SI-S-45-184F



Sharp – Sharp
SI-S-45-184C
SI-S-45-184G



Beebee
100 mm – 4 "
120 mm – 4 3/4 "
Curved, saw edge for
Soft wire up to ø 0.8 mm



Blunt – Blunt
SI-S-45-185
SI-S-45-185D



Sharp – Sharp
SI-S-45-185A
SI-S-45-185E



Blunt – Blunt, Saw edge
SI-S-45-185B
SI-S-45-185F



Sharp – Sharp
SI-S-45-185C
SI-S-45-185G

Ciseaux pour pansements
Bandage scissors
Tijeras para vendajes
Forbici per bendaggi



Universal
150 mm – 6 " **SI-S-45-186**
180 mm – 7 " **SI-S-45-186A**



Lister
90 mm – 3 1/2 " **SI-S-45-187**
110 mm – 4 1/4 " **SI-S-45-187A**
140 mm – 5 1/2 " **SI-S-45-187B**
160 mm – 6 1/4 " **SI-S-45-187C**
180 mm – 7 " **SI-S-45-187D**
200 mm – 8 " **SI-S-45-187E**



Bandage Scissor
180 mm – 7 " **SI-S-45-188**
200 mm – 8 " **SI-S-45-188A**

Ciseaux pour pansements
Bandage scissors
Tijeras para vendajes
Forbici per bendaggi



Lange
180 mm – 7 "
SI-S-45-189



Knowles
140 mm – 5 1/2 "
SI-S-45-190



Bandage Scissor
160 mm – 6 1/4 "
SI-S-45-191



Smith (Mod. USA)
160 mm – 6 1/4 "
180 mm – 7 "
200 mm – 8 "
230 mm – 9 "

SI-S-45-192
SI-S-45-192A
SI-S-45-192B
SI-S-45-192C

Ciseaux pour pansements
Bandage scissors
Tijeras para vendajes
Forbici per bendaggi



Esmarch
200 mm – 8 "
220 mm – 8 3/4 "

SI-S-45-193
SI-S-45-193A



Excentric
160 mm – 6 1/4 "
190 mm – 7 1/2 "
Saw edge

SI-S-45-194
SI-S-45-194A

Ciseaux pour pansements
Bandage scissors
Tijeras para vendajes
Forbici per bendaggi



Bergmann
230 mm – 9 "
SI-S-45-195



Lorenz
230 mm – 9 "
SI-S-45-196

Cisailles pour plâtres
Plaster shears
Cizallas para vendajes enyesados
Cesoie per apparecchi gessati



Brun's
240 mm



SI-S-45-197



SI-S-45-198
Saw edge

Cisailles pour plâtres
Plaster shears
Cizallas para vendajes enyesados
Cesoie per apparecchi gessati



Plaster Shears
200 mm – 8 "
SI-S-45-199



Plaster Shears
230 mm – 9 "
SI-S-45-200

Ciseaux à envies – Ciseaux à ongles
Cuticle scissors – Nail scissors
Tijeras cuticulares – Tijeras para uñas
Forbici per unghie e cuticole



Cuticle
100 mm
110 mm



Straight

SI-S-45-201

SI-S-45-201A



Curved

SI-S-45-202

SI-S-45-202A



Cuticle
100 mm
110 mm



Straight

SI-S-45-203

SI-S-45-203A



Curved

SI-S-45-204

SI-S-45-204A

Ciseaux à ongles
Nail splitting scissors
Tijeras para uñas
Forbici per unghie



Nail Splitting Scissors
130 mm – 5 " **SI-S-45-205**
150 mm – 6 " **SI-S-45-205A**



Systrunk
130 mm – 5 "



Straight
SI-S-45-206



Curved
SI-S-45-207

Ciseaux à chirurgie
Operating scissors
Tijeras para cirugía
Forbici per chirurgia



Lexer
160 mm – 6 1/4 "



Straight
SI-S-45-252



Curved
SI-S-45-253



Mayo

140 mm
150 mm
170 mm
230 mm



Straight
SI-S-45-254
SI-S-45-254A
SI-S-45-254B
SI-S-45-254C



Curved
SI-S-45-255
SI-S-45-255A
SI-S-45-255B
SI-S-45-255C

Ciseaux à chirurgie
Operating scissors
Tijeras para cirugía
Forbici per chirurgia



Mayo-Stille

150 mm
170 mm



Straight

SI-S-45-256
SI-S-45-256A



Curved

SI-S-45-257
SI-S-45-257A



Metzenbaum
145 mm – 5 3/4 "



Straight

SI-S-45-258



Curved

SI-S-45-259

Ciseaux à chirurgie
Operating scissors
Tijeras para cirugía
Forbici per chirurgia



Metzenbaum-Nelson

180 mm – 7 "
200 mm – 8 "
230 mm – 9 "



Fig. 1

SI-S-45-260



Fig. 1

SI-S-45-261

SI-S-45-260A SI-S-45-261A

SI-S-45-260B SI-S-45-261B



Operating Scissor
115 mm – 4 1/2 "



Straight

SI-S-45-262



Curved

SI-S-45-263

Ciseaux à chirurgie
Operating scissors
Tijeras para cirugía
Forbici per chirurgia



Metzenbaum-Fino

145 mm
180 mm
200 mm
230 mm



Fig. 1
SI-S-45-265
SI-S-45-265A
SI-S-45-265B
SI-S-45-265C



Fig. 2
SI-S-45-266
SI-S-45-266A
SI-S-45-266B
SI-S-45-266C



Straight SI-S-45-267 Curved SI-S-45-268

Operating Scissor
115 mm – 4 1/2 "



Kilner (Ragnell)
120 mm – 4 3/4 "
150 mm – 6 "
180 mm – 7 "
200 mm – 8 "

SI-S-45-264
SI-S-45-264A
SI-S-45-264B
SI-S-45-264C



Ciseaux à chirurgie
Operating scissors
Tijeras para cirugía
Forbici per chirurgia



Goldmann-Fox
130 mm – 5 "



Straight
SI-S-45-269



Curved
SI-S-45-270



Joseph
140 mm – 5 1/2 "



Straight
SI-S-45-271



Curved
SI-S-45-272

Ciseaux à chirurgie
Operating scissors
Tijeras para cirugía
Forbici per chirurgia



Reynolds
160 mm – 6 1/4 "
180 mm – 7 "



Straight
SI-S-45-273
SI-S-45-273A



Curved
SI-S-45-274
SI-S-45-274A



Stevens
100 mm – 4 "
110 mm – 4 1/4 "



Straight
SI-S-45-275
SI-S-45-273B



Curved
SI-S-45-275A
SI-S-45-274C



Fomon
130 mm – 5 "
SI-S-45-276

Ciseaux à chirurgie
Operating scissors
Tijeras para cirugía
Forbici per chirurgia



Standard

Straight
145 mm
165 mm



Fig. 1

SI-S-45-208
SI-S-45-208A



Fig. 2

SI-S-45-209
SI-S-45-209A



Fig. 3

SI-S-45-210
SI-S-45-210A



Standard

Curved
145 mm
165 mm



Fig. 1

SI-S-45-211
SI-S-45-211A



Fig. 2

SI-S-45-212
SI-S-45-212A



Fig. 3

SI-S-45-213
SI-S-45-213A

Ciseaux à chirurgie
Operating scissors
Tijeras para cirugía
Forbici per chirurgia



Lexer
165 mm – 6 1/4 "
210 mm – 8 1/4 "



Straight
SI-S-45-214
SI-S-45-214A



Curved
SI-S-45-215
SI-S-45-215A



Mayo
145 mm – 5 3/4 "
170 mm – 6 3/4 "
230 mm – 9 "



Straight
SI-S-45-216
SI-S-45-216A
SI-S-45-216B



Curved
SI-S-45-217
SI-S-45-217A
SI-S-45-217B

Ciseaux à dissection
Dissecting scissors
Tijeras de disección
Forbici per dissezione



Mayo-Stillé
150 mm – 6 "
170 mm – 6 3/4 "



Straight
SI-S-45-218
SI-S-45-218A

Curved
SI-S-45-219
SI-S-45-219A



Metzenbaum



Straight
115 mm
145 mm

Fig. 1
SI-S-45-220
SI-S-45-220A

Fig. 2
SI-S-45-221
SI-S-45-221A

Fig. 3
SI-S-45-222
SI-S-45-222A

Ciseaux à dissection
Dissecting scissors
Tijeras de disección
Forbici per dissezione



Metzenbaum

Curved
115 mm
145 mm



Fig. 1

SI-S-45-223
SI-S-45-223A



Fig. 2

SI-S-45-224
SI-S-45-224A



Fig. 3

SI-S-45-225
SI-S-45-225A



Metzenbaum-Nelson

Straight
180 mm
200 mm
230 mm
250 mm
280 mm
300 mm



Fig. 1

SI-S-45-226
SI-S-45-226A
SI-S-45-226B
SI-S-45-226C
SI-S-45-226D
SI-S-45-226E



Fig. 2

SI-S-45-227
SI-S-45-227A
SI-S-45-227B
SI-S-45-227C
SI-S-45-227D
SI-S-45-227E



Fig. 3

SI-S-45-228
SI-S-45-228A
SI-S-45-228B
SI-S-45-228C
SI-S-45-228D
SI-S-45-228E

Ciseaux à dissection
Dissecting scissors
Tijeras de disección
Forbici per dissezione



Metzenbaum-Nelson

Curved
180 mm
200 mm
230 mm
250 mm
280 mm
300 mm



Fig. 1

SI-S-45-229
SI-S-45-229A
SI-S-45-229B
SI-S-45-229C
SI-S-45-229D
SI-S-45-229E



Fig. 2

SI-S-45-230
SI-S-45-230A
SI-S-45-230B
SI-S-45-230C
SI-S-45-230D
SI-S-45-230E



Fig. 3

SI-S-45-231
SI-S-45-231A
SI-S-45-231B
SI-S-45-231C
SI-S-45-231D
SI-S-45-231E



Metzenbaum-Fino

145 mm



Straight
Fig. 1

SI-S-45-232



Curved
Fig. 1

SI-S-45-233

Ciseaux à dissection
Dissecting scissors
Tijeras de disección
Forbici per dissezione



Metzenbaum-Fino



Straight
Fig. 3

145 mm **SI-S-45-234**



Curved
Fig. 3

SI-S-45-235



Metzenbaum-Fino
180 mm – 7 "
200 mm – 8 "
230 mm – 9 "



Straight
SI-S-45-236
SI-S-45-236A
SI-S-45-236B



Curved
SI-S-45-237
SI-S-45-237A
SI-S-45-237B



Metzenbaum-Fino
180 mm – 7 " **SI-S-45-238**
200 mm – 8 " **SI-S-45-238A**
230 mm – 9 " **SI-S-45-238B**
S-curved

Ciseaux à dissection
Dissecting scissors
Tijeras de disección
Forbici per dissezione



Locklin
165 mm – 6 1/2 "
SI-S-45-239
Straight, saw edge



Locklin
165 mm – 6 1/2 "
SI-S-45-240
Curved, saw edge

Ciseaux vasculaires
Artery scissors
Tijeras vasculares
Forbici vascolari



De Bakey
160 mm
230 mm
280 mm



SI-S-45-241
SI-S-45-241C
SI-S-45-241F

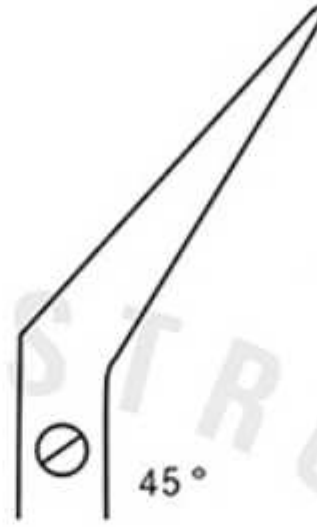

SI-S-45-241A
SI-S-45-241D
SI-S-45-241G

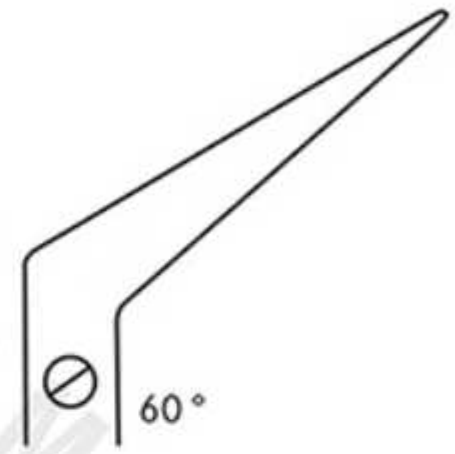

SI-S-45-241B
SI-S-45-241E
SI-S-45-241H



Potts-
De Martel
190 mm



SI-S-45-242

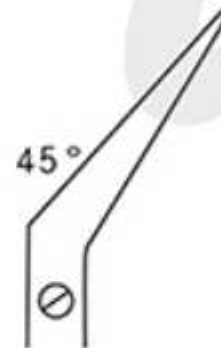

SI-S-45-242A

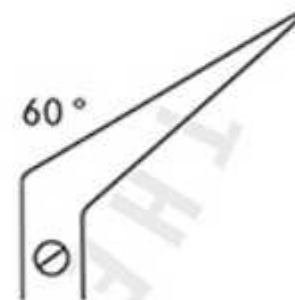

SI-S-45-242B

Ciseaux pour les amygdales
Tonsil scissors
Tijera para amigdales
Forbici per tonsille



Toennis-Adson
170 mm – 6 3/4 "
SI-S-45-243



Dean
170 mm – 6 3/4 "
SI-S-45-244
Curved, saw edge

Parametrium ciseaux
Parametrium scissors
Parametrium tijera
Forbici per il parametrio



Parametrium Scissors

Ciseaux à iridectomie
Iris scissors
Tijeras para iridectomia
Forbici per iridectomia



Iris
115 mm – 4 1/2 "



Straight
SI-S-45-246



Curved
SI-S-45-247



Angular
SI-S-45-248



Universal
120 mm – 4 3/4 "
SI-S-45-249

Ciseaux pour pansements
Bandage scissors
Tijeras para vendajes
Forbici per bendaggi



Lister
180 mm – 7 "
SI-S-45-250



Bruns
240 mm – 9 1/2 "
SI-S-45-251

Si **SURGICA**
INSTRUMENTS
THE NAME OF EXCELLENCE



HAEMOSTATIC FORCEPS

- HAEMOSTATIC FORCEPS
- DISSECTING & LIGATURE FORCEPS
- KIDNEY PEDICLE & GALL DUCT FORCEPS
- CLAMP & PERITONEAL FORCEPS
- HYSTERECTOMY FORCEPS
- PARAMETRIUM TC FORCEPS
- BRONCHUS & VASCULAR CLAMPS
- TOWEL FORCEPS

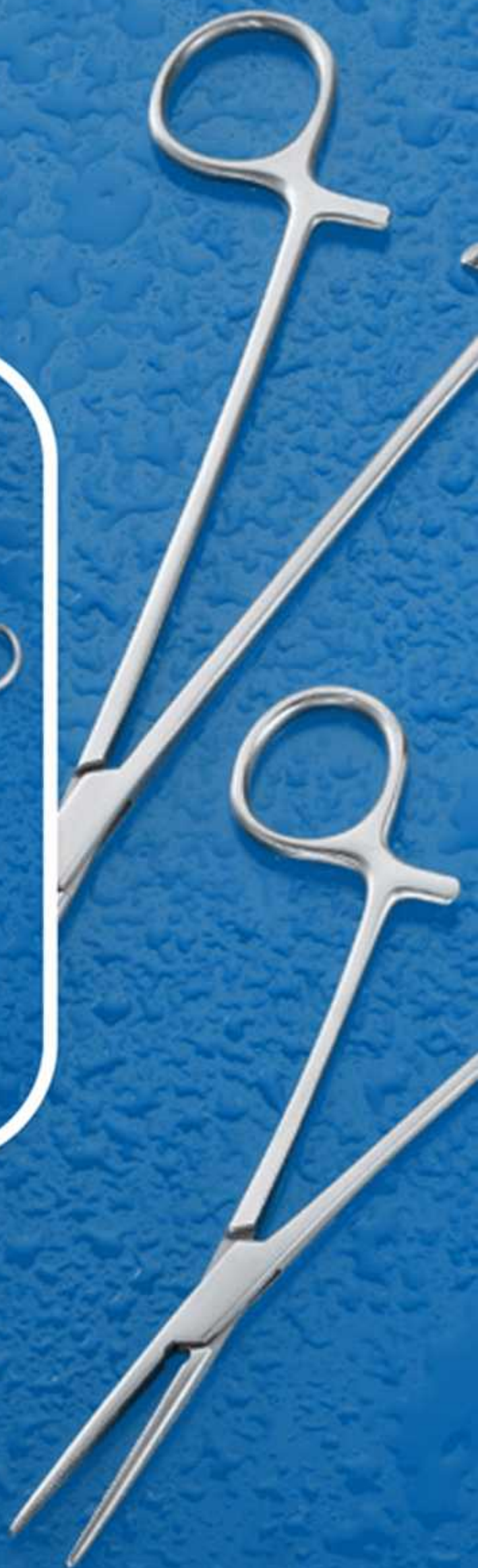

Pinces hémostatiques
Haemostatic forceps
Pinzas hemostáticas
Pinze emostatiche



Hartmann
100 mm – 4"



Terrier
85 mm – 3 3/4"
SI-F-46-03



Halsted-Mosquito
125 mm – 5"
140 mm – 5 1/2"

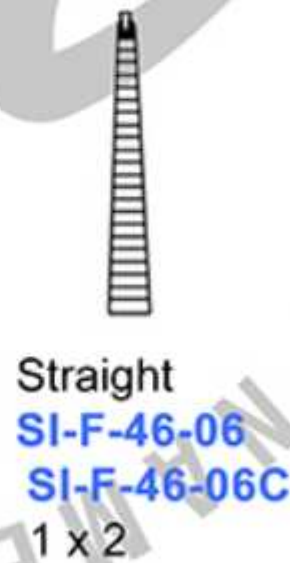
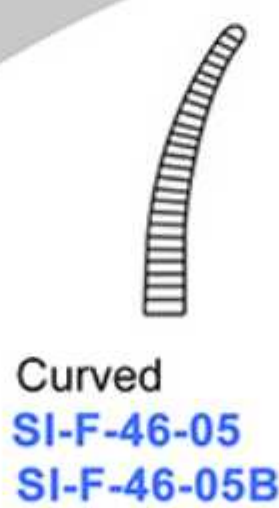
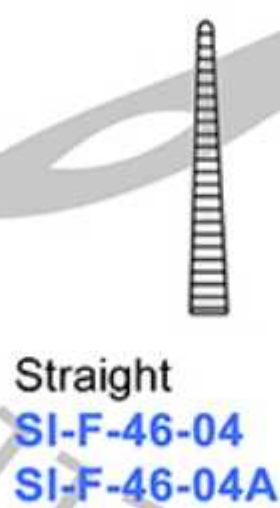

Pinces hémostatiques
Haemostatic forceps
Pinzas hemostáticas
Pinze emostatiche



Micro-Mosquito
100 mm – 4"
120 mm – 4 3/4"



Straight
SI-F-46-08
SI-F-46-08A



Curved
SI-F-46-09
SI-F-46-09A



Straight
SI-F-46-10
SI-F-46-10A



Curved
SI-F-46-11
SI-F-46-11A



SI-F-46-14



SI-F-46-15
1 x 2



Dandy
140 mm – 5 1/2"
Curved to the side

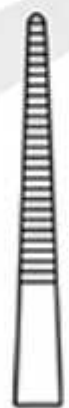

Straight
SI-F-46-12



Curved
SI-F-46-13



Providence-Hospital
140 mm – 5 1/2"

HAEMOSTATIC FORCEPS

Pinces hémostatiques
Haemostatic forceps
Pinzas hemostáticas
Pinze emostatiche



Mosquito-Dandy
120 mm – 4 3/4 "
SI-F-46-16
Curved to the side



Christophe
130 mm – 4 " **SI-F-46-17**
150 mm – 6 " **SI-F-46-17A**



Lovelace
155 mm – 6 "

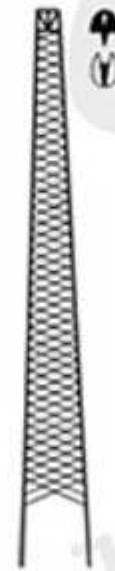

SI-F-46-18
1 x 2

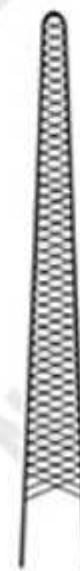

SI-F-46-19

Pinces hémostatiques
Haemostatic forceps
Pinzas hemostáticas
Pinze emostatiche



Leriche
150 mm – 6"

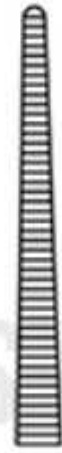

Straight
SI-F-46-20



Curved
SI-F-46-21



Leriche
150 mm – 6"



Straight
SI-F-46-22
1 x 2



Curved
SI-F-46-23
1 x 2

Pinces hémostatiques
Haemostatic forceps
Pinzas hemostáticas
Pinze emostatiche



Kelly
140 mm – 5 1/2"

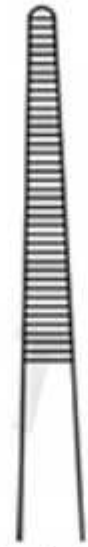

Straight
SI-F-46-24



Curved
SI-F-46-25



Crile
140 mm – 5 1/2"



Straight
SI-F-46-26

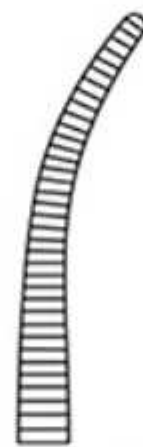

Curved
SI-F-46-27



Straight
SI-F-46-28
1 x 2



Curved
SI-F-46-29
1 x 2

HAEMOSTATIC FORCEPS

Pinces hémostatiques
Haemostatic forceps
Pinzas hemostáticas
Pinze emostatiche



Coller
140 mm – 5 1/2 "
160 mm – 6 1/4 "

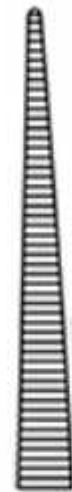

Straight
SI-F-46-30
SI-F-46-30A



Curved
SI-F-46-31
SI-F-46-31A



Dunhill
125 mm – 5 "
SI-F-46-34



Péan
130 mm – 5 "
140 mm – 5 1/2 "
160 mm – 6 1/4 "
Delicate pattern

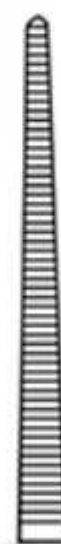

Straight
SI-F-46-32
SI-F-46-32A
SI-F-46-32B

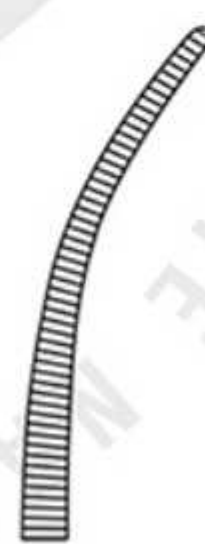

Curved
SI-F-46-33
SI-F-46-33A
SI-F-46-33B

HAEMOSTATIC FORCEPS

Pinces hémostatiques
Haemostatic forceps
Pinzas hemostáticas
Pinze emostatiche



Cairns
150 mm – 6"



Straight
SI-F-46-35



Curved
SI-F-46-36



Kocher
130 mm
140 mm
160 mm



Straight
SI-F-46-37
SI-F-46-37A
SI-F-46-37B
1 x 2



Curved
SI-F-46-38
SI-F-46-38A
SI-F-46-38B
1 x 2

Delicate pattern

Pinces hémostatiques
Haemostatic forceps
Pinzas hemostáticas
Pinze emostatiche

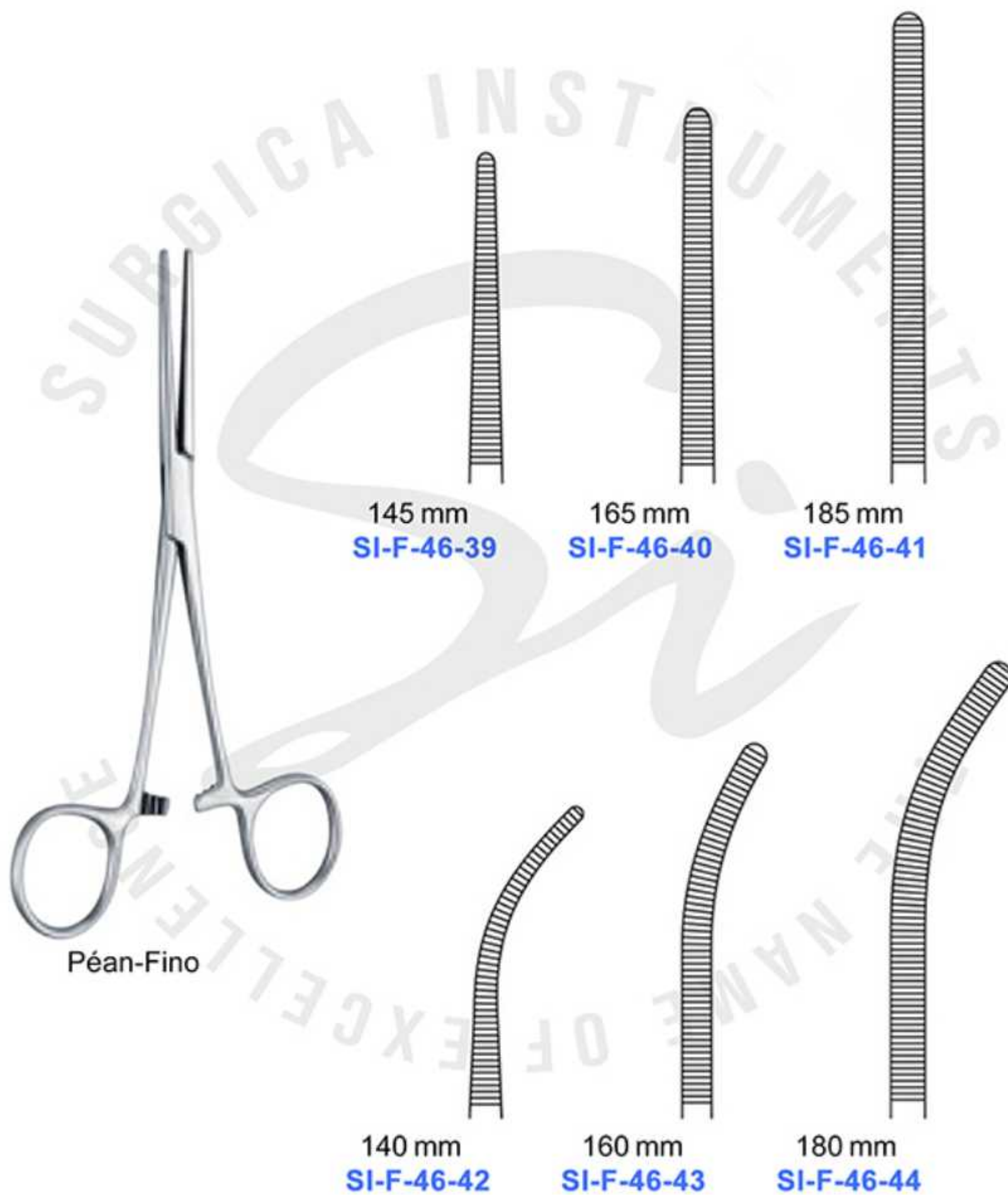

Pinces hémostatiques
Haemostatic forceps
Pinzas hemostáticas
Pinze emostatiche



Kocher-Fino



145 mm
SI-F-46-45
1 x 2



165 mm
SI-F-46-46
1 x 2



185 mm
SI-F-46-47
1 x 2



140 mm
SI-F-46-48
1 x 2



160 mm
SI-F-46-49
1 x 2



180 mm
SI-F-46-50
1 x 2

Pinces hémostatiques
Haemostatic forceps
Pinzas hemostáticas
Pinze emostatiche



Rochester-Péan



140 mm
SI-F-46-51



160 mm
SI-F-46-52



180 mm
SI-F-46-53



200 mm
SI-F-46-54



220 mm
SI-F-46-55

Pinces hémostatiques
Haemostatic forceps
Pinzas hemostáticas
Pinze emostatiche



Rochester-Péan



240 mm

SI-F-46-56



260 mm

SI-F-46-57



300 mm

SI-F-46-58



350 mm

SI-F-46-59

Pinces hémostatiques
Haemostatic forceps
Pinzas hemostáticas
Pinze emostatiche

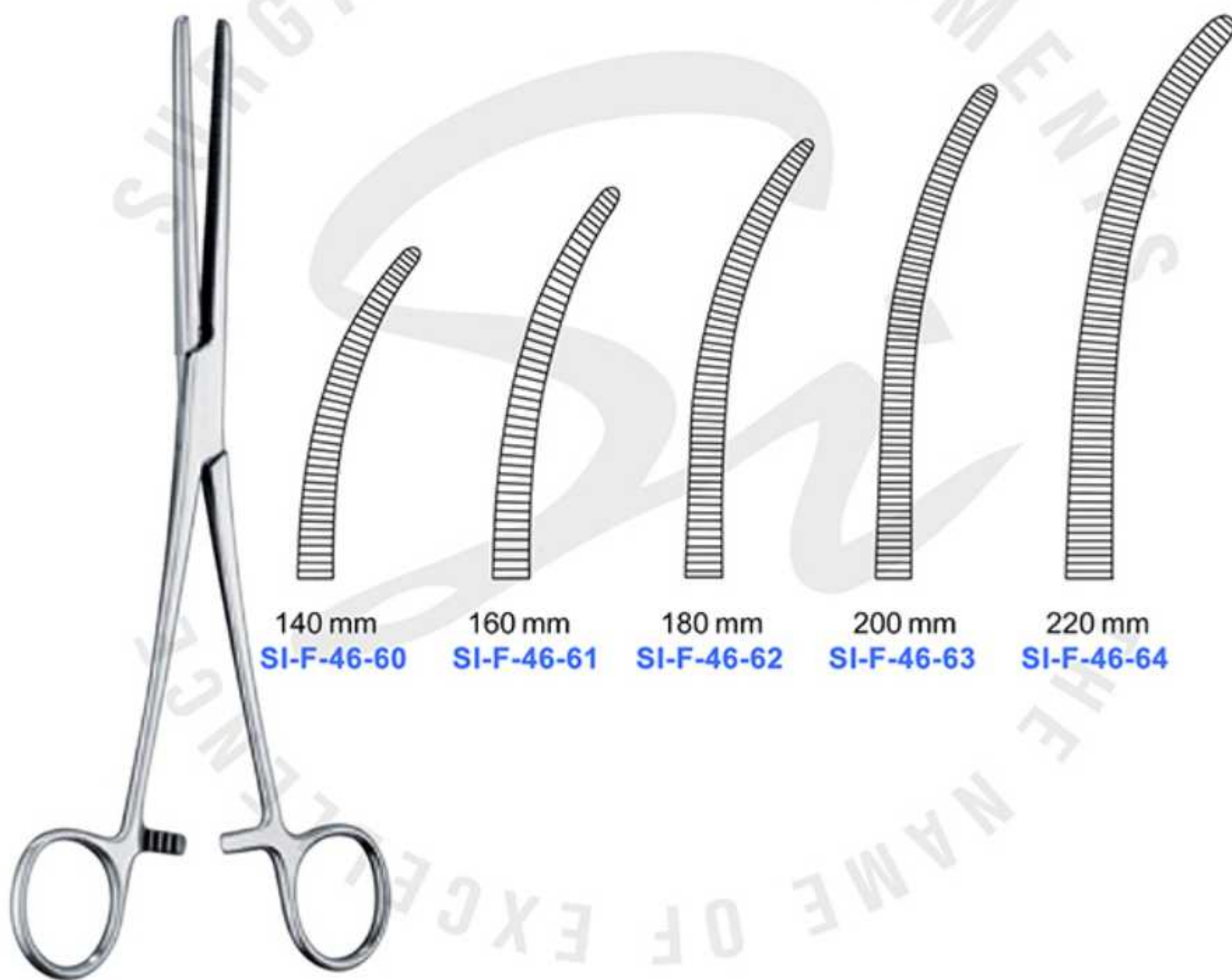

Rochester-Péan

Pinces hémostatiques
Haemostatic forceps
Pinzas hemostáticas
Pinze emostatiche



Rochester-Péan

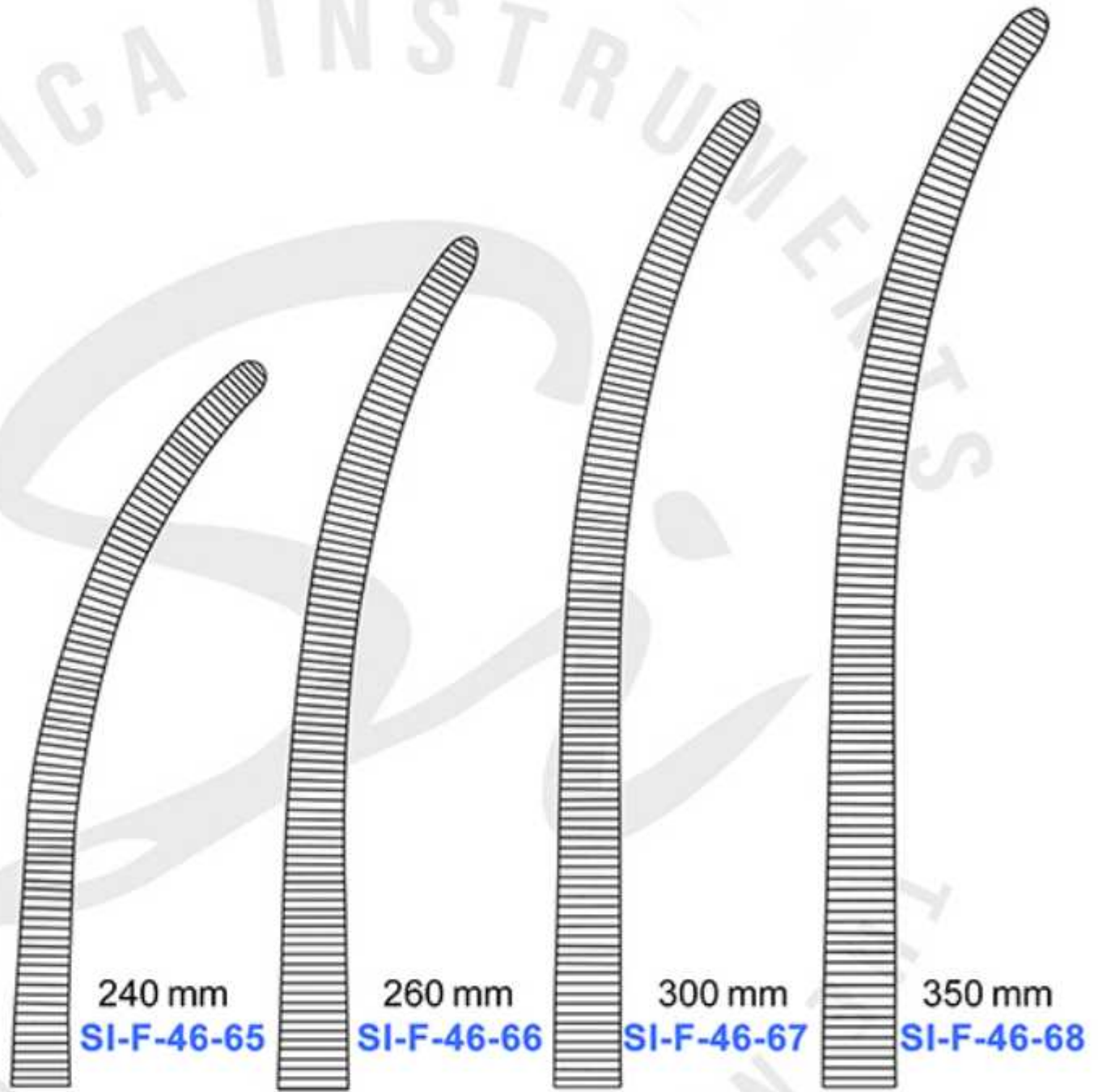

Pinces hémostatiques
Haemostatic forceps
Pinzas hemostáticas
Pinze emostatiche



Ochsner-Kocher



140 mm
SI-F-46-69
1 x 2



160 mm
SI-F-46-70
1 x 2



180 mm
SI-F-46-71
1 x 2



200 mm
SI-F-46-72
1 x 2

Pinces hémostatiques
Haemostatic forceps
Pinzas hemostáticas
Pinze emostatiche



Pinces hémostatiques
Haemostatic forceps
Pinzas hemostáticas
Pinze emostatiche

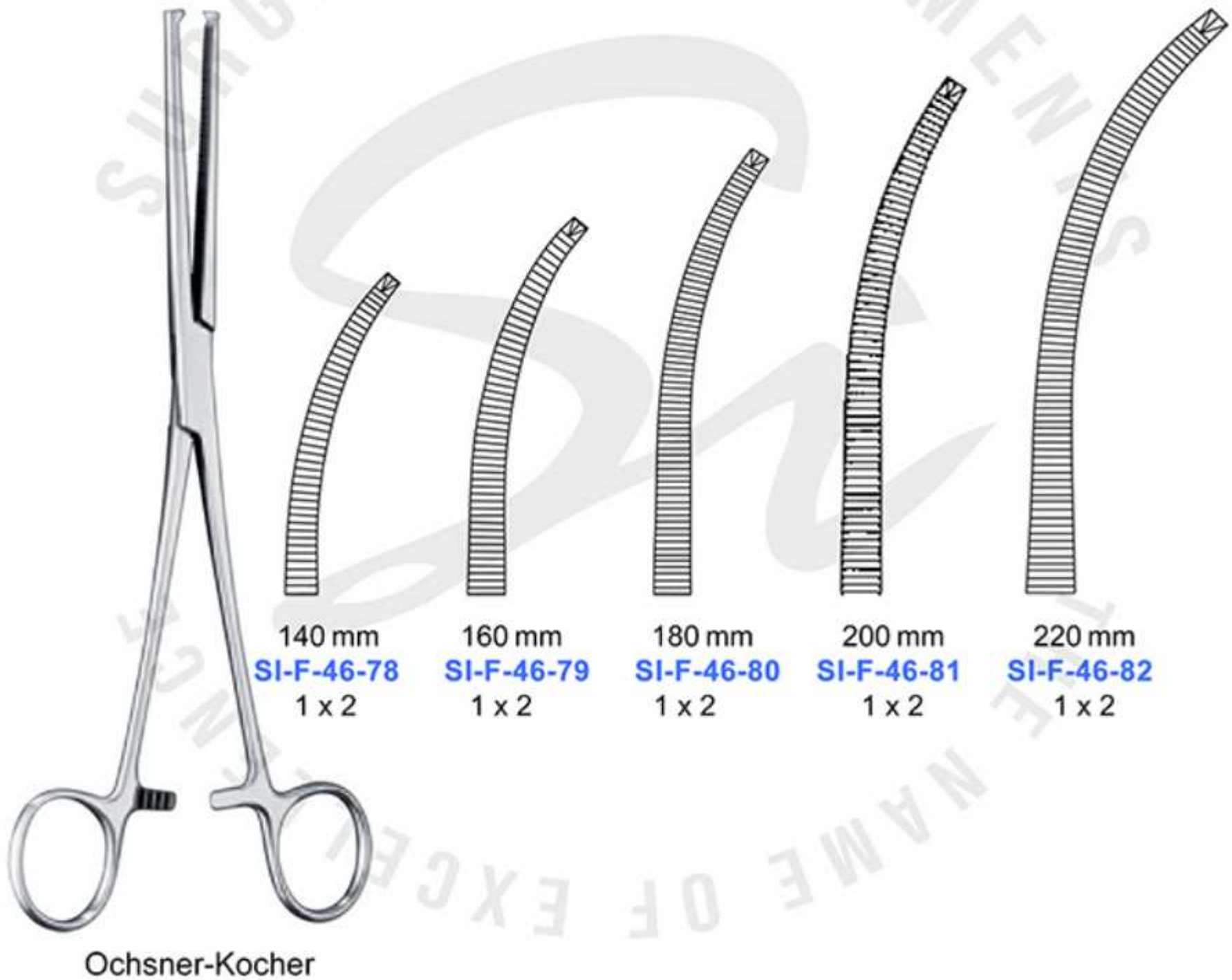

Pinces hémostatiques
Haemostatic forceps
Pinzas hemostáticas
Pinze emostatiche

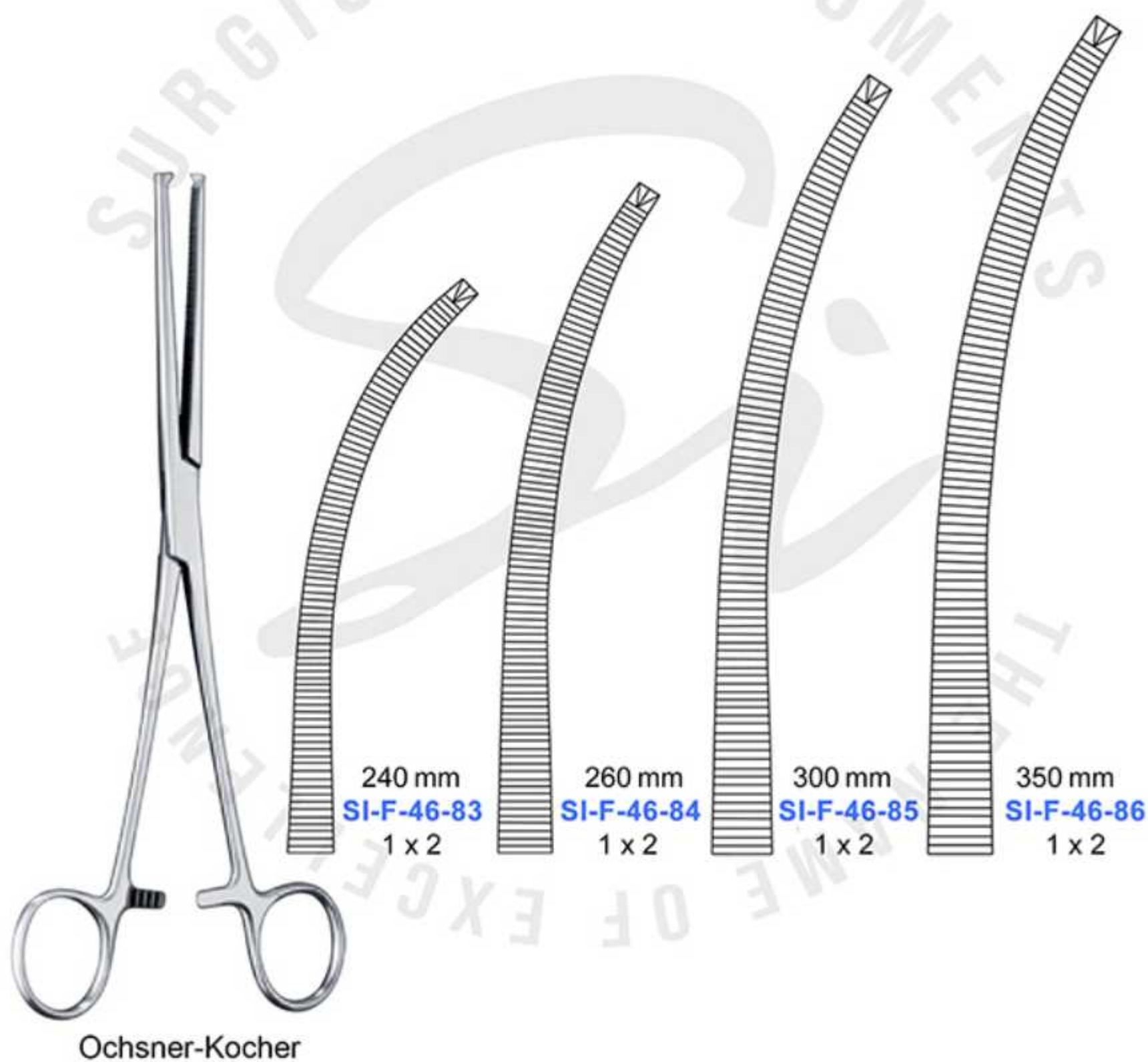

Pinces hémostatiques
Haemostatic forceps
Pinzas hemostáticas
Pinze emostatiche

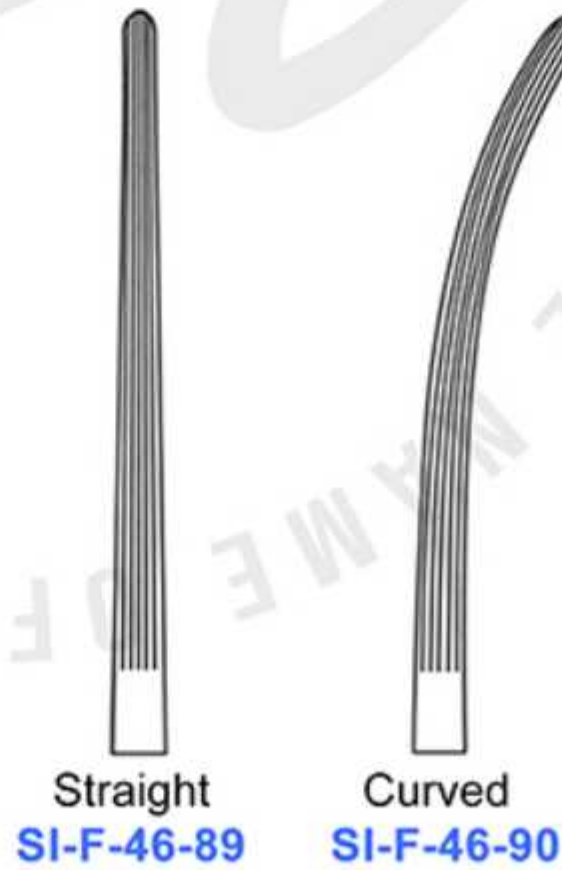
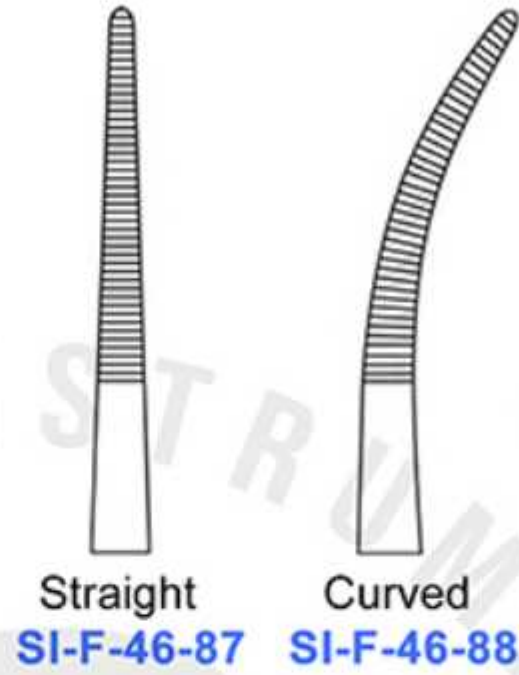

Pinces hémostatiques
Haemostatic forceps
Pinzas hemostáticas
Pinze emostatiche



Péan
120 mm – 4 3/4" **SI-F-46-91**
140 mm – 5 1/2" **SI-F-46-91A**
160 mm – 6 1/4" **SI-F-46-91B**



Chaput
130 mm – 5"
SI-F-46-94



Rochester-Carmalt
160 mm
200 mm



Straight
SI-F-46-92
SI-F-46-92A



Curved
SI-F-46-93
SI-F-46-93A

Pinces hémostatiques
Haemostatic forceps
Pinzas hemostáticas
Pinze emostatiche



Tuffier
130 mm – 5"
SI-F-46-95

Pennington
155 mm – 6"
200 mm – 8"
SI-F-46-96
SI-F-46-96A



Collin
140 mm – 5 1/2"
SI-F-46-97



Martel
140 mm – 5 1/2"
SI-F-46-99



Pratt
150 mm – 6"
SI-F-46-98

Pinces hémostatiques
Haemostatic forceps
Pinzas hemostáticas
Pinze emostatiche



Fergusson
160 mm – 6 1/4" **SI-F-46-100**
200 mm – 8" **SI-F-46-100A**

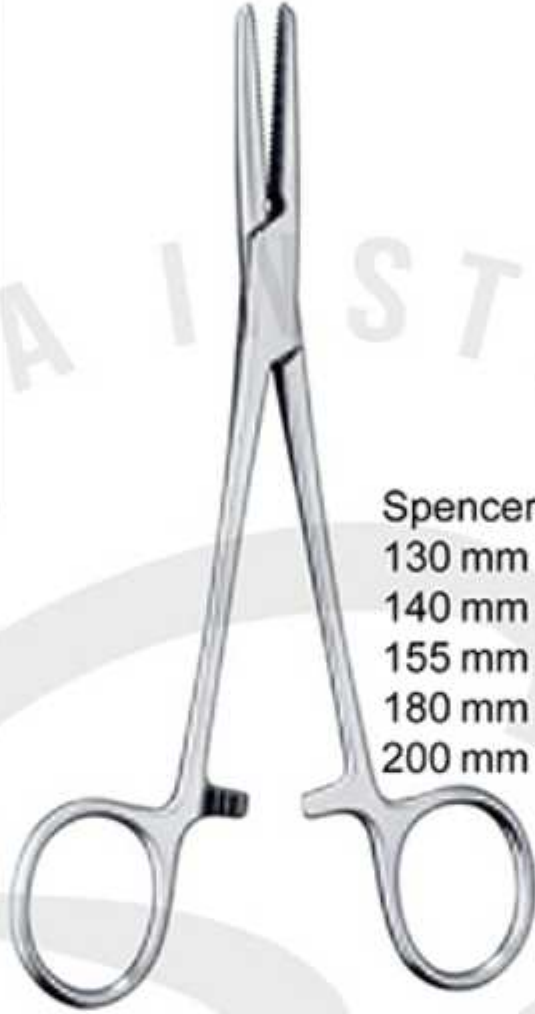

Spencer-Wells
130 mm **SI-F-46-101** **SI-F-46-102**
140 mm **SI-F-46-101A** **SI-F-46-102A**
155 mm **SI-F-46-101B** **SI-F-46-102B**
180 mm **SI-F-46-101C** **SI-F-46-102C**
200 mm **SI-F-46-101D** **SI-F-46-102D**

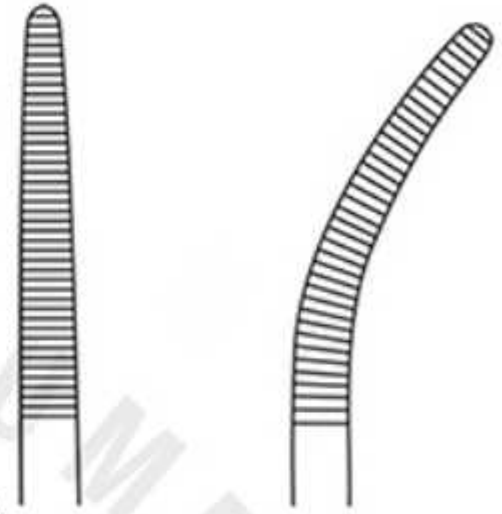

Halsted-Mosquito
180 mm – 7"
210 mm – 8 1/4"

	Straight	Curved	Straight	Curved
	SI-F-46-103	SI-F-46-104	SI-F-46-105	SI-F-46-106
	SI-F-46-103A	SI-F-46-104A	SI-F-46-105A	SI-F-46-106A

Pinces hémostatiques
Haemostatic forceps
Pinzas hemostáticas
Pinze emostatiche



Bengolea	Straight	Curved	Straight	Curved
200 mm	SI-F-46-107	SI-F-46-108	SI-F-46-109	SI-F-46-110
240 mm	SI-F-46-107A	SI-F-46-108A	SI-F-46-109A	SI-F-46-110A
260 mm	SI-F-46-107B	SI-F-46-108B	SI-F-46-109B	SI-F-46-110B

Pinces hémostatiques
Haemostatic forceps
Pinzas hemostáticas
Pinze emostatiche



Adson
185 mm – 7 1/4"

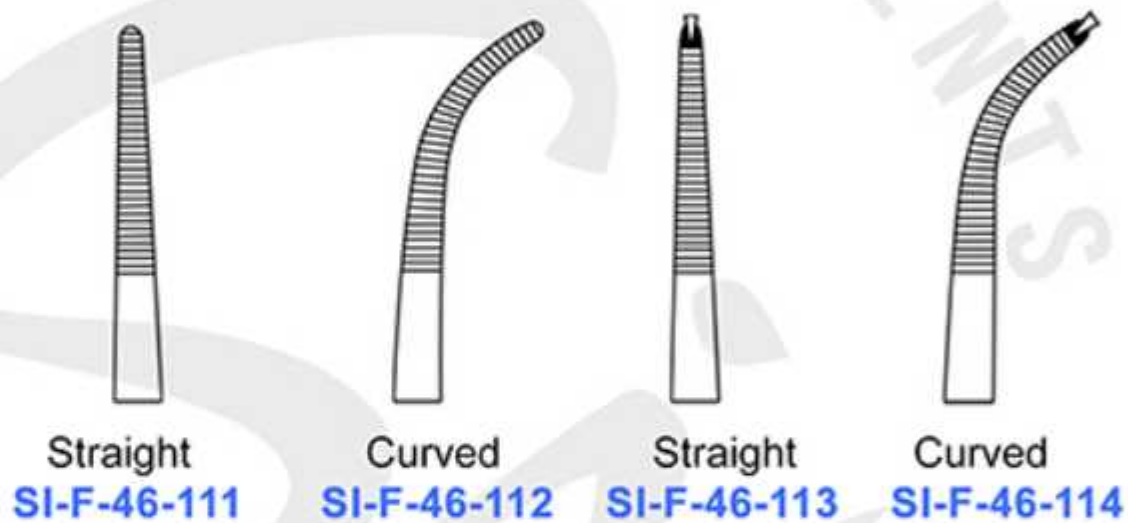

Pinces hémostatiques
Haemostatic forceps
Pinzas hemostáticas
Pinze emostatiche



Heiss
200 mm – 8"

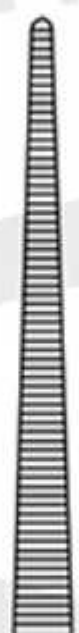

Straight
SI-F-46-115



S-Curved
SI-F-46-116

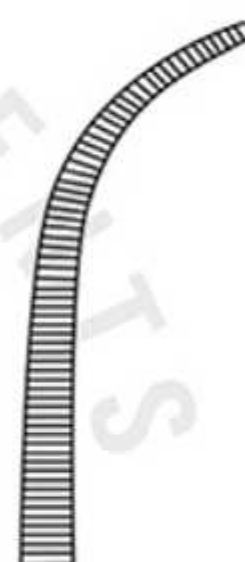

Curved
SI-F-46-117

Pinces hémostatiques
Haemostatic forceps
Pinzas hemostáticas
Pinze emostatiche



Baby-Mixer

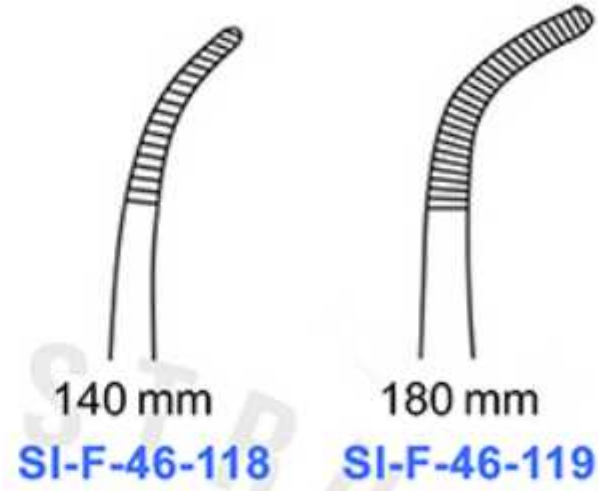

Baby-Adson

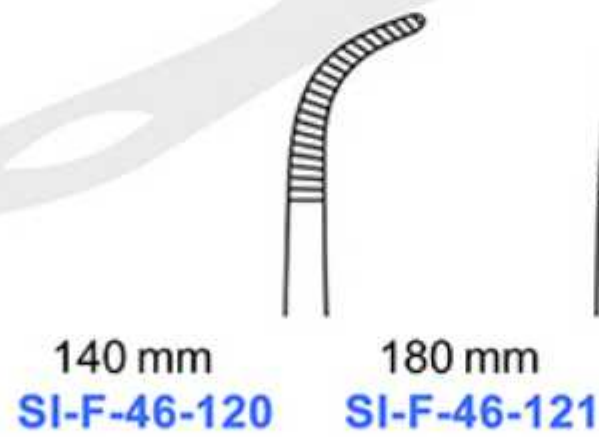

Baby-Overholt
135 mm – 5 1/4 "
SI-F-46-122

Pinces hémostatiques
Haemostatic forceps
Pinzas hemostáticas
Pinze emostatiche



Kelly-Fraser

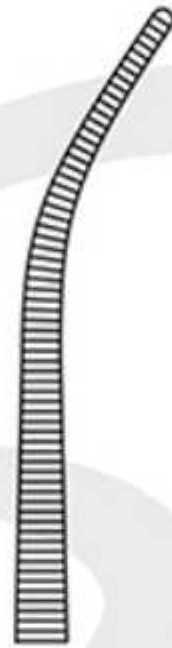

Fig. 1
195 mm
SI-F-46-123

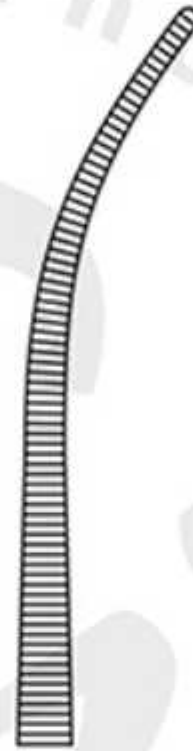

Fig. 1
225 mm
SI-F-46-124



Fig. 1
245 mm
SI-F-46-125

Pinces hémostatiques
Haemostatic forceps
Pinzas hemostáticas
Pinze emostatiche



Fig. 2
190 mm
SI-F-46-126

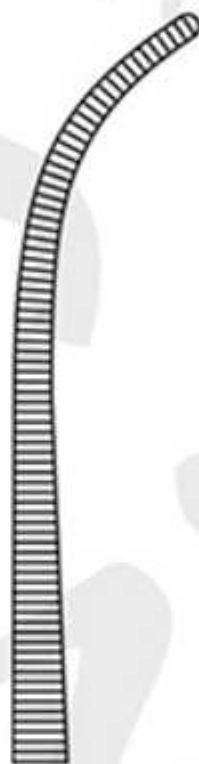

Fig. 2
220 mm
SI-F-46-127

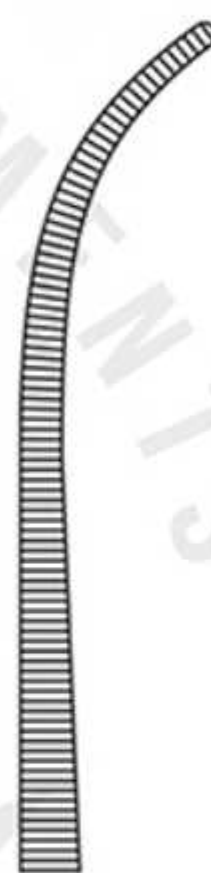

Fig. 2
240 mm
SI-F-46-128

Pinces hémostatiques
Haemostatic forceps
Pinzas hemostáticas
Pinze emostatiche



Kelly-Fraser

Fig. 3
185 mm
SI-F-46-129

Fig. 3
215 mm
SI-F-46-130

Fig. 3
235 mm
SI-F-46-131

Pinces hémostatiques
Haemostatic forceps
Pinzas hemostáticas
Pinze emostatiche



Schnidt
190 mm – 7 1/2"

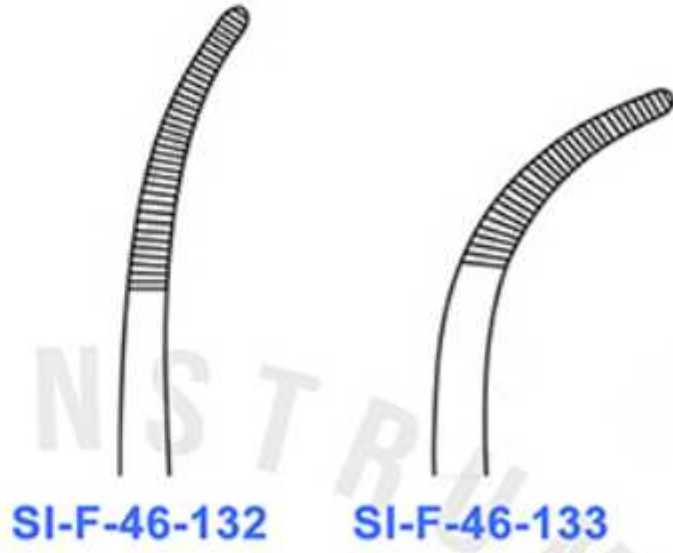

SI-F-46-132

SI-F-46-133



Nissen
190 mm – 7 1/2"
SI-F-46-134

Pinces hémostatiques
Haemostatic forceps
Pinzas hemostáticas
Pinze emostatiche



Toennis
210 mm – 8 1/4 "
260 mm – 10 1/4 "



Straight
SI-F-46-135
SI-F-46-135A



Curved
SI-F-46-136
SI-F-46-136A



Straight
SI-F-46-137
SI-F-46-137A

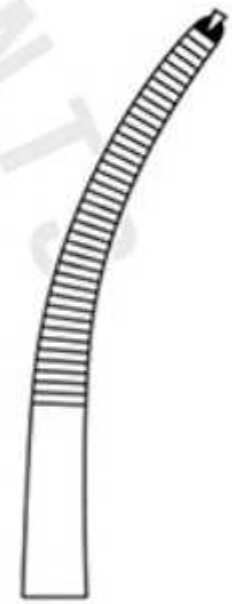

Curved
SI-F-46-138
SI-F-46-138A

Pinces hémostatiques
Haemostatic forceps
Pinzas hemostáticas
Pinze emostatiche



Meeker
180 mm – 7"
275 mm – 10 3/4"
Curved, 90°
SI-F-46-144
SI-F-46-144A

Lawrence
280 mm – 11"
SI-F-46-145

Pinces hémostatiques
Haemostatic forceps
Pinzas hemostáticas
Pinze emostatiche



Rumel
230 mm – 9"



Fig. 1
SI-F-46-139



Fig. 2
SI-F-46-140



Fig. 3
SI-F-46-141

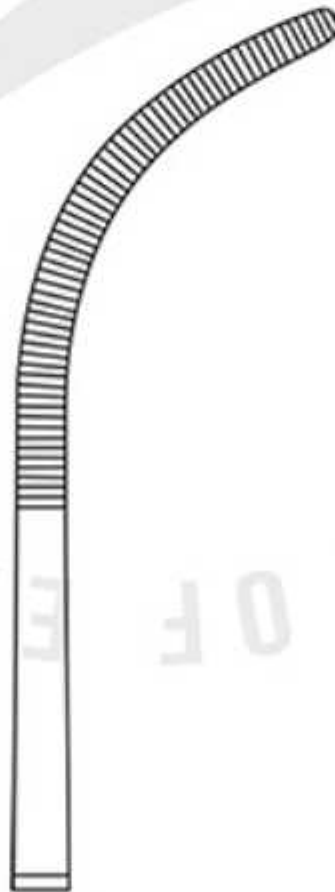

Fig. 4
SI-F-46-142



Fig. 5
SI-F-46-143

Pinces à disséquer et à sutures
Dissecting and ligature forceps
Pinzas para preparación y suturas
Pinze per preparazioni e suture



Overholt-Geissendoerfer

Overholt-
Geissendoerfer

210 mm
270 mm



Fig. 0

SI-F-46-146
SI-F-46-146A



Fig. 1

SI-F-46-147
SI-F-46-147A

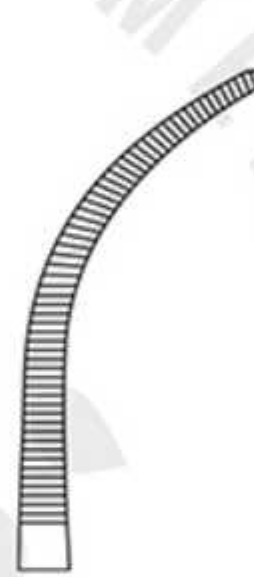

Fig. 2

SI-F-46-148
SI-F-46-148A



Fig. 3

SI-F-46-149
SI-F-46-149A

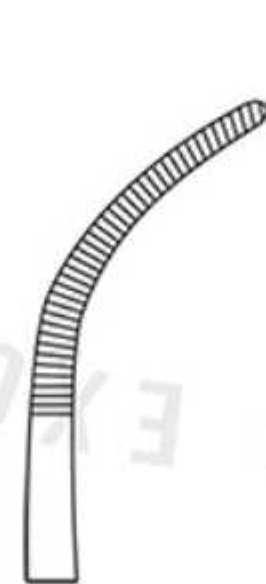

Fig. 4

SI-F-46-150
SI-F-46-150A

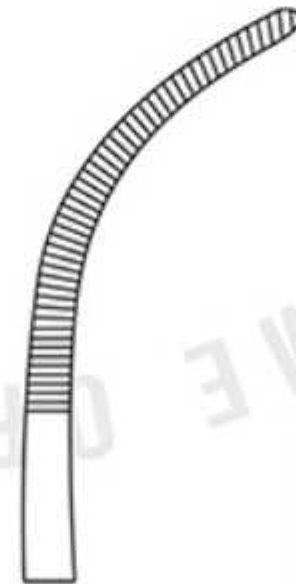

Fig. 5

SI-F-46-151
SI-F-46-151A



Fig. 6

SI-F-46-152
SI-F-46-152A

Pinces à disséquer et à sutures
Dissecting and ligature forceps
Pinzas para preparación y suturas
Pinze per preparazioni e suture



Overholt-Fino



Fig. 0
215 mm
SI-F-46-153



Fig. 1
210 mm
SI-F-46-154



Fig. 2
220 mm
SI-F-46-155

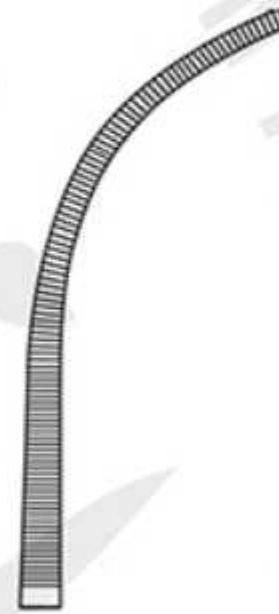

Fig. 3
230 mm
SI-F-46-156



Fig. 6
225 mm
SI-F-46-157

Pinces à disséquer et à sutures
Dissecting and ligature forceps
Pinzas para preparación y suturas
Pinze per preparazioni e suture



Overholt

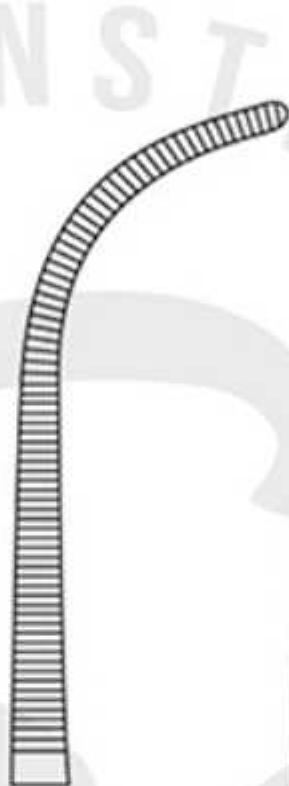

Fig. 0
295 mm

SI-F-46-158

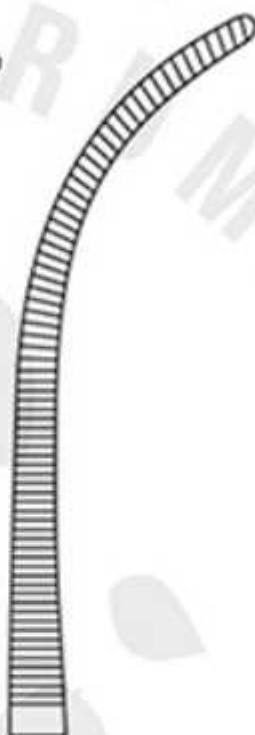

Fig. 1
295 mm

SI-F-46-159



Fig. 6
300 mm

SI-F-46-160

Pinces à disséquer et à sutures
Dissecting and ligature forceps
Pinzas para preparación y suturas
Pinze per preparazioni e suture



185 mm **SI-F-46-161** 205 mm **SI-F-46-162** 210 mm **SI-F-46-163** 215 mm **SI-F-46-164**

Overholt-Modifiziert
S-Curved



Overholt-Mixer
210 mm – 8 1/4" **SI-F-46-165**

Pinces à disséquer et à sutures
Dissecting and ligature forceps
Pinzas para preparación y suturas
Pinze per preparazioni e suture



SI-F-46-166

SI-F-46-167

Bridge
280 mm – 11 "

Pinces à disséquer et à sutures
Dissecting and ligature forceps
Pinzas para preparación y suturas
Pinze per preparazioni e suture



Gemini



130 mm

SI-F-46-168



160 mm

SI-F-46-169



180 mm

SI-F-46-170



200 mm

SI-F-46-171

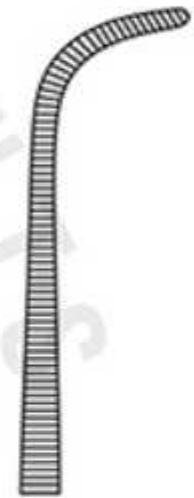

230 mm

SI-F-46-172



250 mm

SI-F-46-173

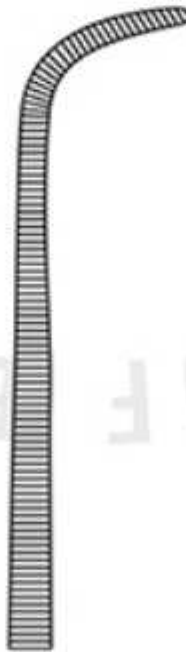

280 mm

SI-F-46-174

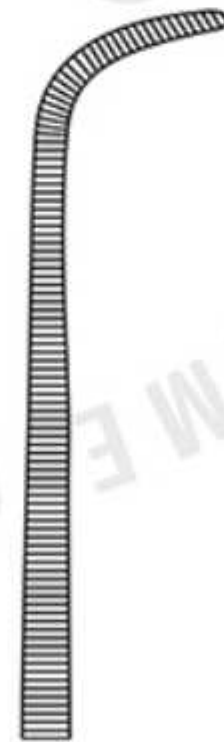

350 mm

SI-F-46-175

Pinces à disséquer et à sutures
Dissecting and ligature forceps
Pinzas para preparación y suturas
Pinze per preparazioni e suture



Mini-Gemini



180 mm
SI-F-46-176

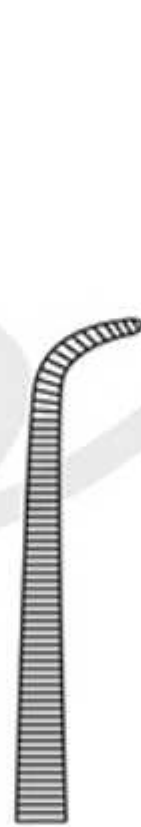

220 mm
SI-F-46-177



250 mm
SI-F-46-178

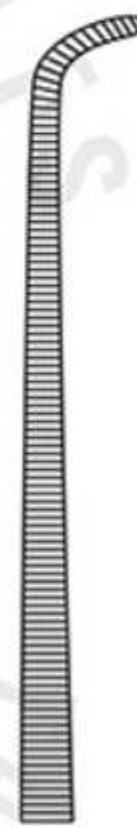

280 mm
SI-F-46-179

Pinces à disséquer et à sutures
Dissecting and ligature forceps
Pinzas para preparación y suturas
Pinze per preparazioni e suture



Zenker
295 mm – 11 1/2 "



SI-F-46-180



SI-F-46-181

Pinces à disséquer et à sutures
Dissecting and ligature forceps
Pinzas para preparación y suturas
Pinze per preparazioni e suture



Roberts
220 mm – 8 3/4 "



Straight
SI-F-46-182



Curved
SI-F-46-183



Mixer
155 mm – 6 " SI-F-46-184
190 mm – 7 1/2 " SI-F-46-184A

Pinces à disséquer et à sutures
Dissecting and ligature forceps
Pinzas para preparación y suturas
Pinze per preparazioni e suture



Kantrowitz
190 mm – 7 1/2 " **SI-F-46-185**
240 mm – 9 1/2 " **SI-F-46-185A**
265 mm – 10 1/2 " **SI-F-46-185B**



Mixer
220 mm – 8 3/4 " **SI-F-46-186**
350 mm – 14 " **SI-F-46-186A**

Pinces à disséquer et à sutures
Dissecting and ligature forceps
Pinzas para preparación y suturas
Pinze per preparazioni e suture



Fickling
180 mm – 7"



SI-F-46-187

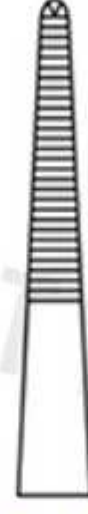

SI-F-46-188

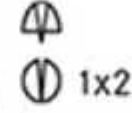

Mixer
230 mm – 9"
SI-F-46-189

Pinces à disséquer et à sutures
Dissecting and ligature forceps
Pinzas para preparación y suturas
Pinze per preparazioni e suture



O'Shaughnessy

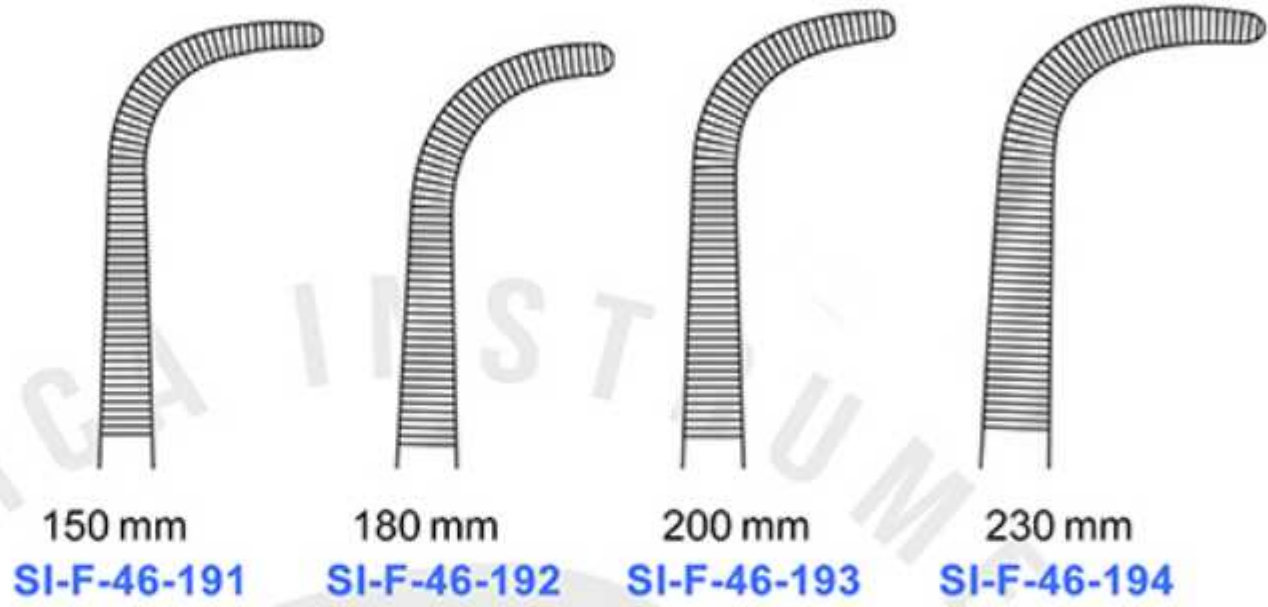

Johns-Hopkins
200 mm – 8" **SI-F-46-190**

Pinces à disséquer et à sutures
Dissecting and ligature forceps
Pinzas para preparación y suturas
Pinze per preparazioni e suture



Mixer-O'Shaughnessy
190 mm – 7 1/2 "
SI-F-46-195

Wickström
210 mm – 8 1/4 " **SI-F-46-196**
240 mm – 9 1/2 " **SI-F-46-196A**

Pinces à disséquer et à sutures
Dissecting and ligature forceps
Pinzas para preparación y suturas
Pinze per preparazioni e suture



Crafoord
180 mm – 7 "
240 mm – 9 1/2 "

SI-F-46-197
SI-F-46-197A

Sarot
240 mm
350 mm

Straight
SI-F-46-198
SI-F-46-198A

Curved
SI-F-46-199
SI-F-46-199A

Pinces à disséquer et à sutures
Dissecting and ligature forceps
Pinzas para preparación y suturas
Pinze per preparazioni e suture



Dean-Shallcross
180 mm – 7 "
SI-F-46-200



Negus
190 mm – 7 1/2 "

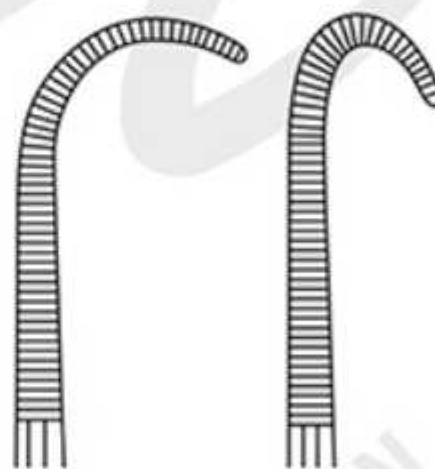

SI-F-46-201

SI-F-46-202

Pinces pour pédicules renaux et voies biliaires
Kidney pedicle and gall duct forceps
Pinzas para pediculos renales y conductos biliares
Pinze per peduncoli renali e vie biliari



Lower
180 mm – 7" **SI-F-46-203**

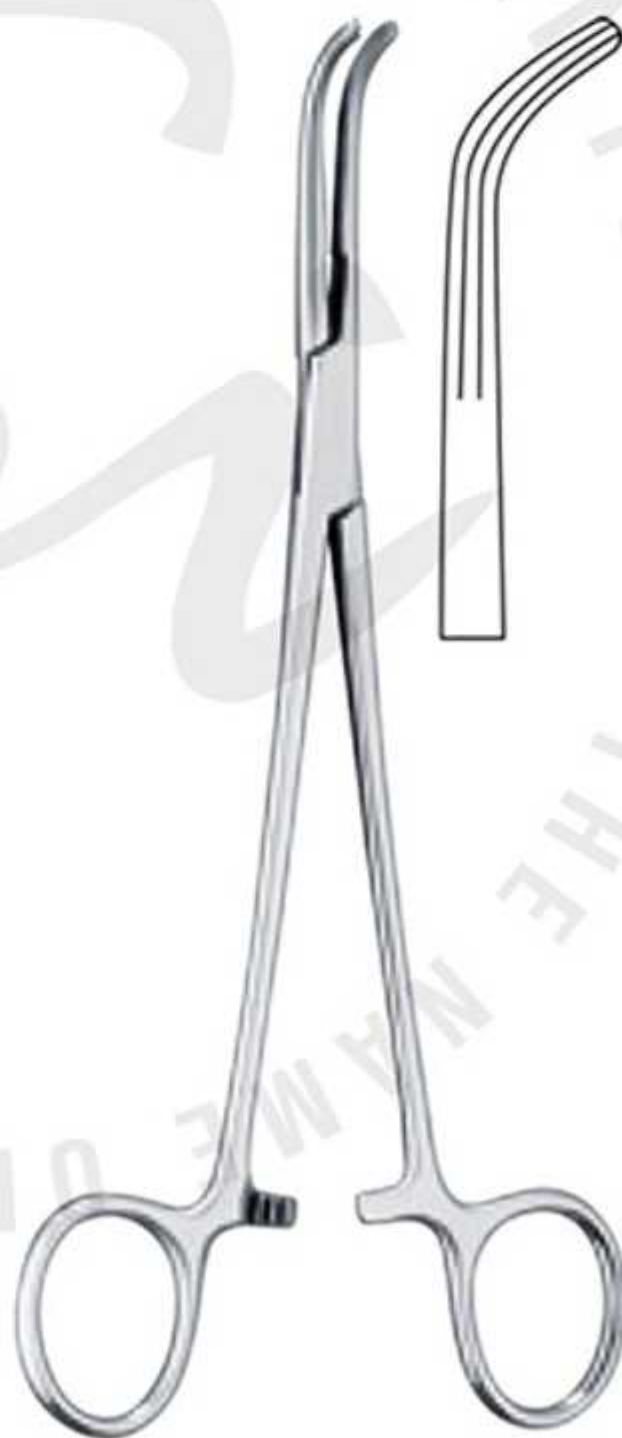

Lahey
190 mm – 7 1/2" **SI-F-46-204**
230 mm – 9" **SI-F-46-204A**

Pinces pour pédicules renaux et voies biliaires
Kidney pedicle and gall duct forceps
Pinzas para pediculos renales y conductos biliares
Pinze per peduncoli renali e vie biliari

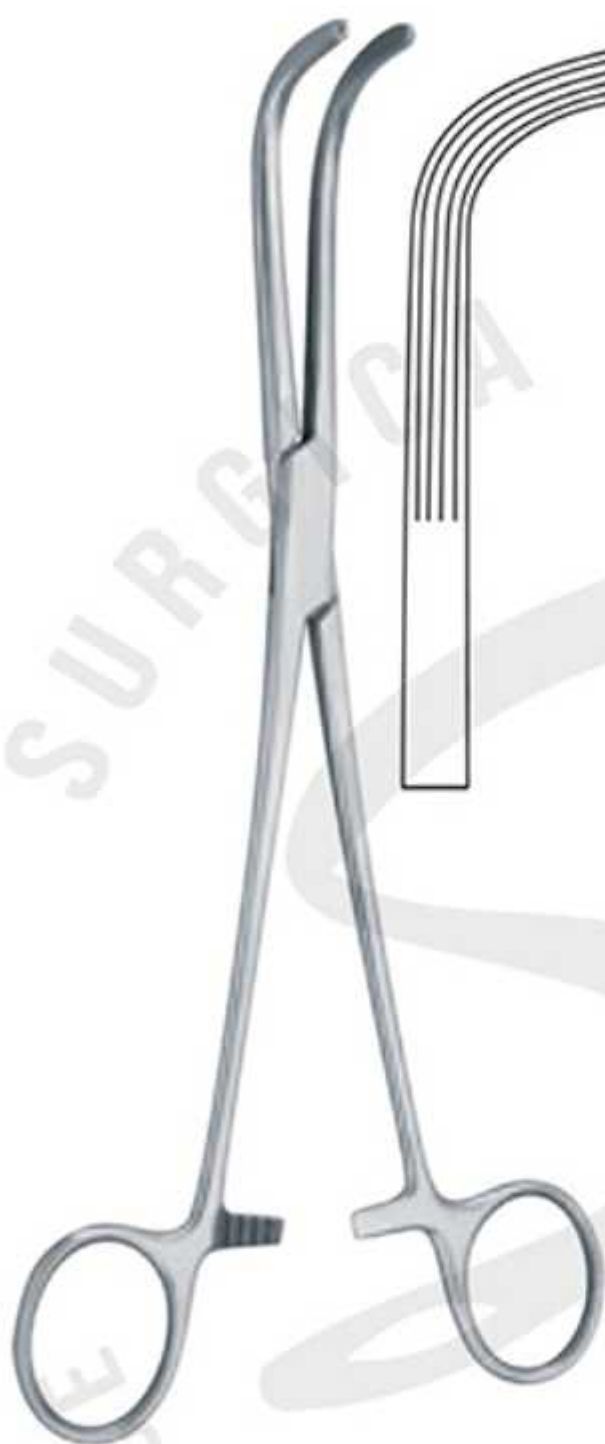

Mc Quigg-Mixter
220 mm – 8 3/4 " **SI-F-46-205**



Finochietto
240 mm – 9 1/2 " **SI-F-46-206**

Pinces pour pédicules renaux et voies biliaires
Kidney pedicle and gall duct forceps
Pinzas para pediculos renales y conductos biliares
Pinze per peduncoli renali e vie biliari



Pinces pour pédicules renaux et voies biliaires
Kidney pedicle and gall duct forceps
Pinzas para pediculos renales y conductos biliares
Pinze per peduncoli renali e vie biliari



Guyon

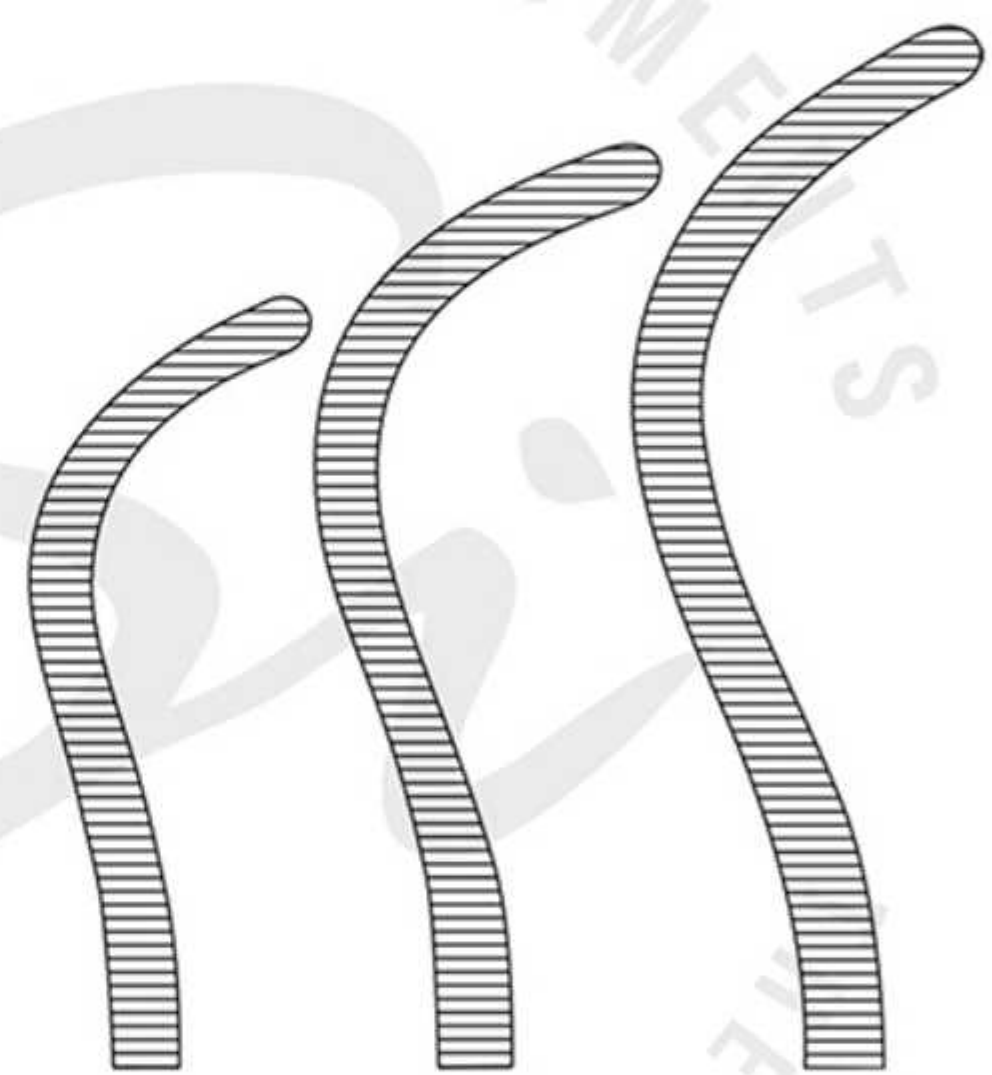

200 mm
SI-F-46-210

220 mm
SI-F-46-211

240 mm
SI-F-46-212

Pinces pour pédicules renaux et voies biliaires
Kidney pedicle and gall duct forceps
Pinzas para pediculos renales y conductos biliares
Pinze per peduncoli renali e vie biliari

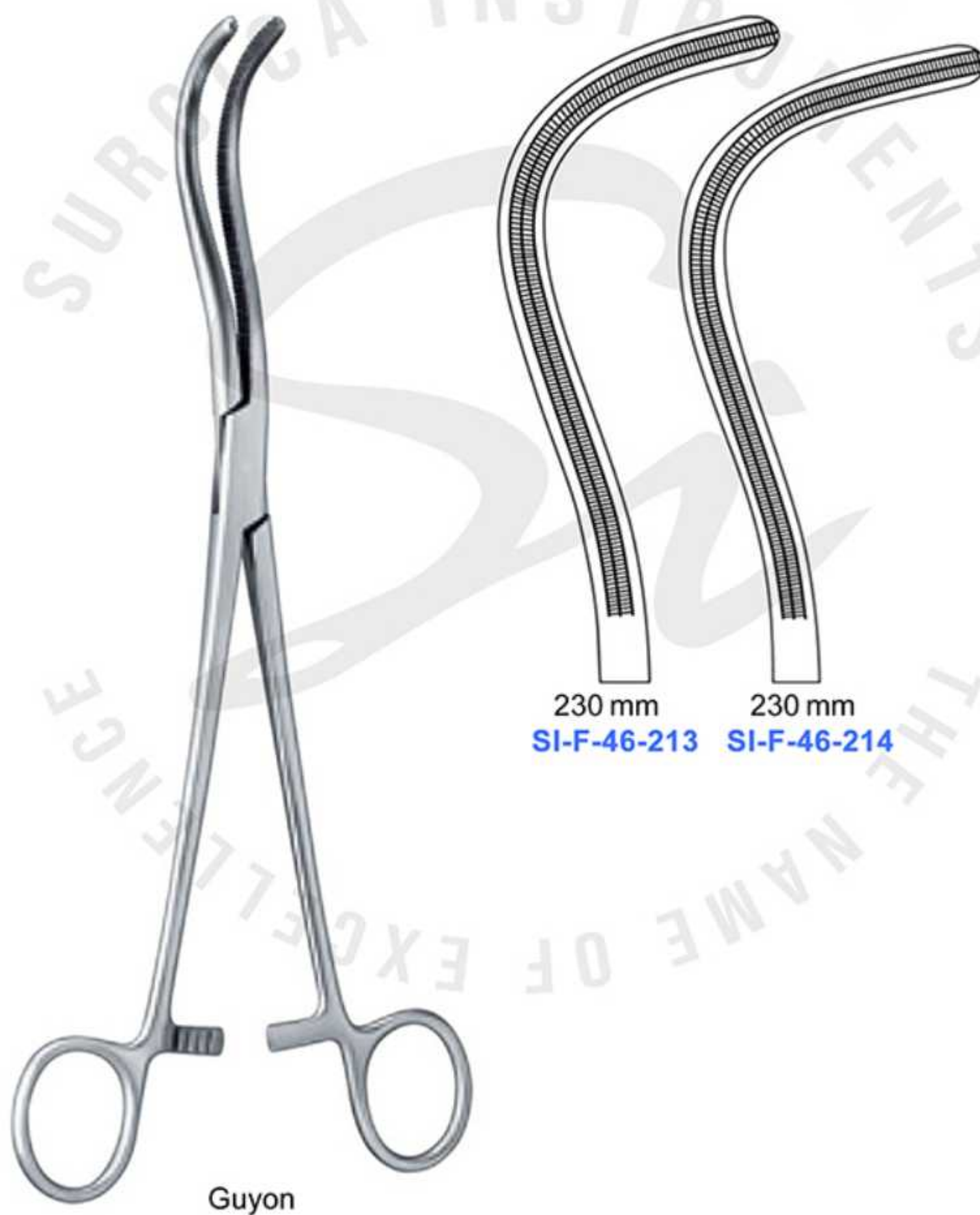

Pinces pour pédicules renaux et voies biliaires
Kidney pedicle and gall duct forceps
Pinzas para pediculos renales y conductos biliares
Pinze per peduncoli renali e vie biliari



Fig. 1
220 mm
SI-F-46-215

Fig. 2
230 mm
SI-F-46-216

Gray

Pinces pour pédicules renaux et voies biliaires
Kidney pedicle and gall duct forceps
Pinzas para pediculos renales y conductos biliares
Pinze per peduncoli renali e vie biliari



Gray

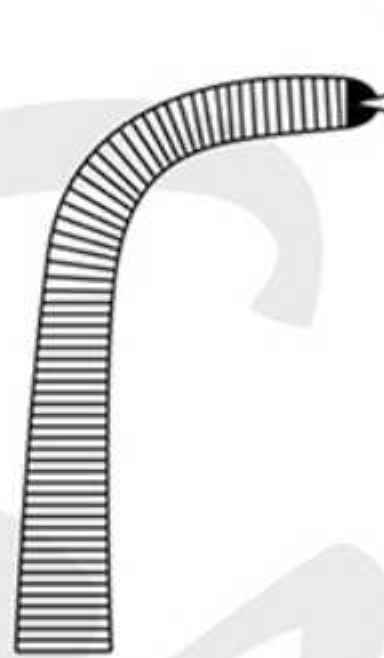

Fig. 1
220 mm
SI-F-46-217
1 x 2

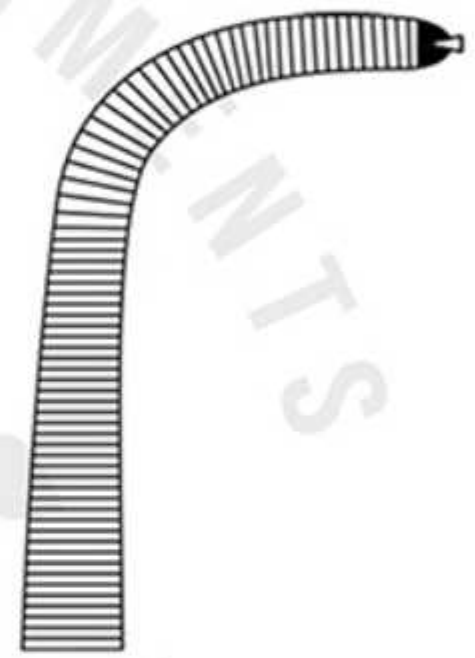

Fig. 2
230 mm
SI-F-46-218
1 x 2

Pinces pour pédicules renaux et voies biliaires
Kidney pedicle and gall duct forceps
Pinzas para pediculos renales y conductos biliares
Pinze per peduncoli renali e vie biliari



Herrick
230 mm – 9 " **SI-F-46-219**



Guyon
230 mm – 9 " **SI-F-46-220**

Pinces pour pédicules renaux et voies biliaires
Kidney pedicle and gall duct forceps
Pinzas para pediculos renales y conductos biliares
Pinze per peduncoli renali e vie biliari



Mayo-Guyon
230 mm – 9 " **SI-F-46-221**

Pinces-clamps – Pinces pour le péritoine
Clamp forceps – Peritoneal forceps
Pinzas-clamps – Pinzas para peritoneo
Pinze per peritoneo



Faure
200 mm – 8 "
SI-F-46-222
1x2



Wertheim
220 mm **SI-F-46-223**
230 mm **SI-F-46-223A**
350 mm **SI-F-46-223B**
1 x 2

Pinces-clamps – Pinces pour le péritoine
Clamp forceps – Peritoneal forceps
Pinzas-clamps – Pinzas para peritoneo
Pinze per peritoneo



Desjardins
200 mm – 8 " **SI-F-46-224**



Desjardins
200 mm – 8 " **SI-F-46-225**

Pinces-clamps – Pinces pour le péritoine
Clamp forceps – Peritoneal forceps
Pinzas-clamps – Pinzas para peritoneo
Pinze per peritoneo



Phaneuf
215 mm – 8 1/2 "

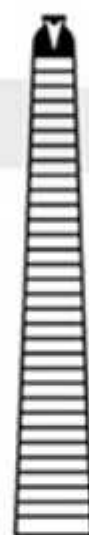

SI-F-46-226
1 x 2



SI-F-46-227
1 x 2

Pinces-clamps – Pinces pour le péritoine
Clamp forceps – Peritoneal forceps
Pinzas-clamps – Pinzas para peritoneo
Pinze per peritoneo



Moynihan

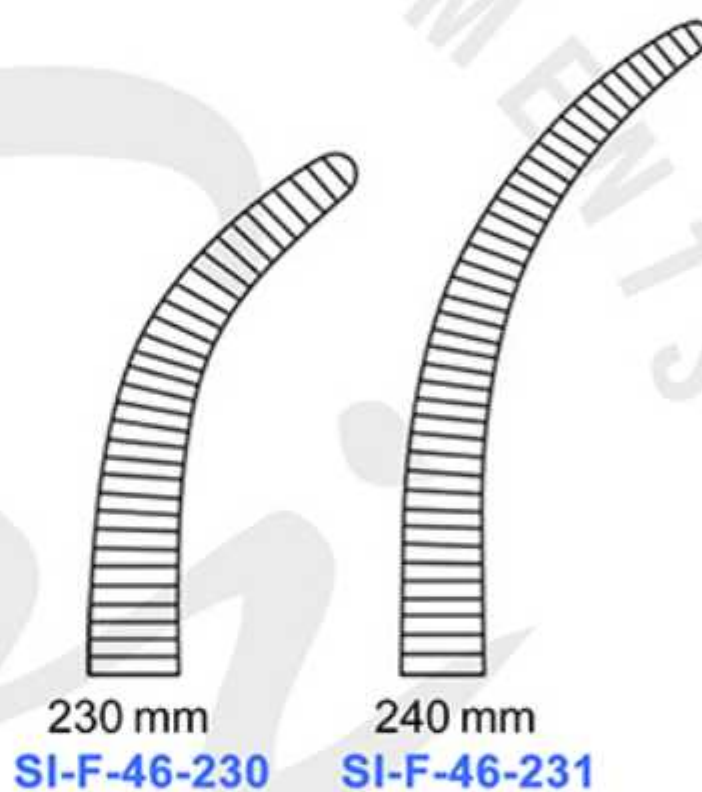

Pinces-clamps – Pinces pour le péritoine
Clamp forceps – Peritoneal forceps
Pinzas-clamps – Pinzas para peritoneo
Pinze per peritoneo



Second-Landau
230 mm – 9"



Curved
SI-F-46-228

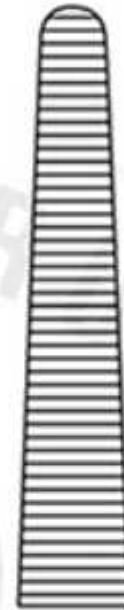

Straight
SI-F-46-229

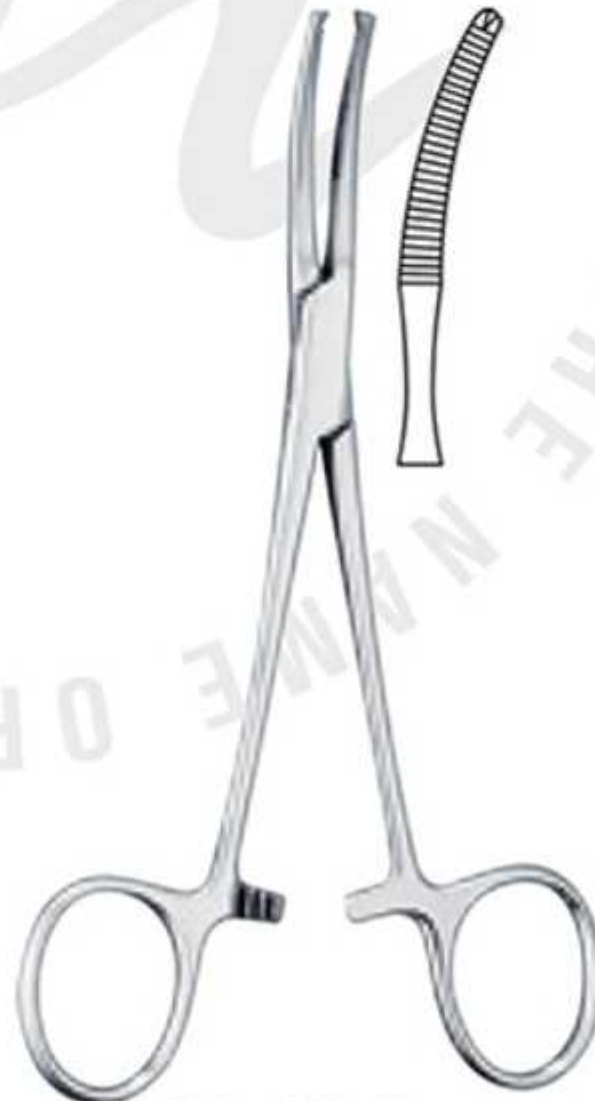

Baby-Mikulicz
140 mm – 4 1/2"
SI-F-46-232
1x2

Pinces-clamps – Pinces pour le péritoine
Clamp forceps – Peritoneal forceps
Pinzas-clamps – Pinzas para peritoneo
Pinze per peritoneo



Mikulicz
180 mm – 7" **SI-F-46-233**



Mikulicz
200 mm – 8" **SI-F-46-234**



Mikulicz
200 mm – 8" **SI-F-46-235**

Pinces-clamps – Pinces pour le péritoine
Clamp forceps – Peritoneal forceps
Pinzas-clamps – Pinzas para peritoneo
Pinze per peritoneo



Maingot
205 mm – 8 "
250 mm – 9 3/4 "
1x2

SI-F-46-236
SI-F-46-236A



Wertheim
250 mm – 9 3/4 " **SI-F-46-237**

Pinces-clamps – Pinces pour le péritoine
Clamp forceps – Peritoneal forceps
Pinzas-clamps – Pinzas para peritoneo
Pinze per peritoneo



Wertheim-Cullen
215 mm – 8 1/2" **SI-F-46-238**

Pinces pour hystérectomie
Hysterectomy forceps
Pinzas para histerecctomia
Pinze per isterectomia



Heaney
210 mm – 8 1/4 " **SI-F-46-239**
230 mm – 9 " **SI-F-46-239A**



Heaney
210 mm – 8 1/4 " **SI-F-46-240**
230 mm – 9 " **SI-F-46-240A**

Pinces pour hystérectomie
Hysterectomy forceps
Pinzas para histerectomia
Pinze per isterectomia



Heaney-Ballantine
210 mm – 8 1/4"

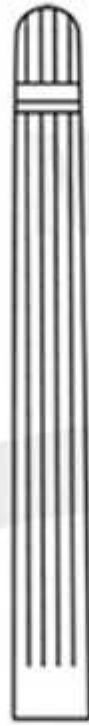

Straight
SI-F-46-242



Curved
SI-F-46-243



Heaney-Rezek
210 mm – 8 1/4" SI-F-46-241

Pinces pour hystérectomie
Hysterectomy forceps
Pinzas para histerectomia
Pinze per isterectomia

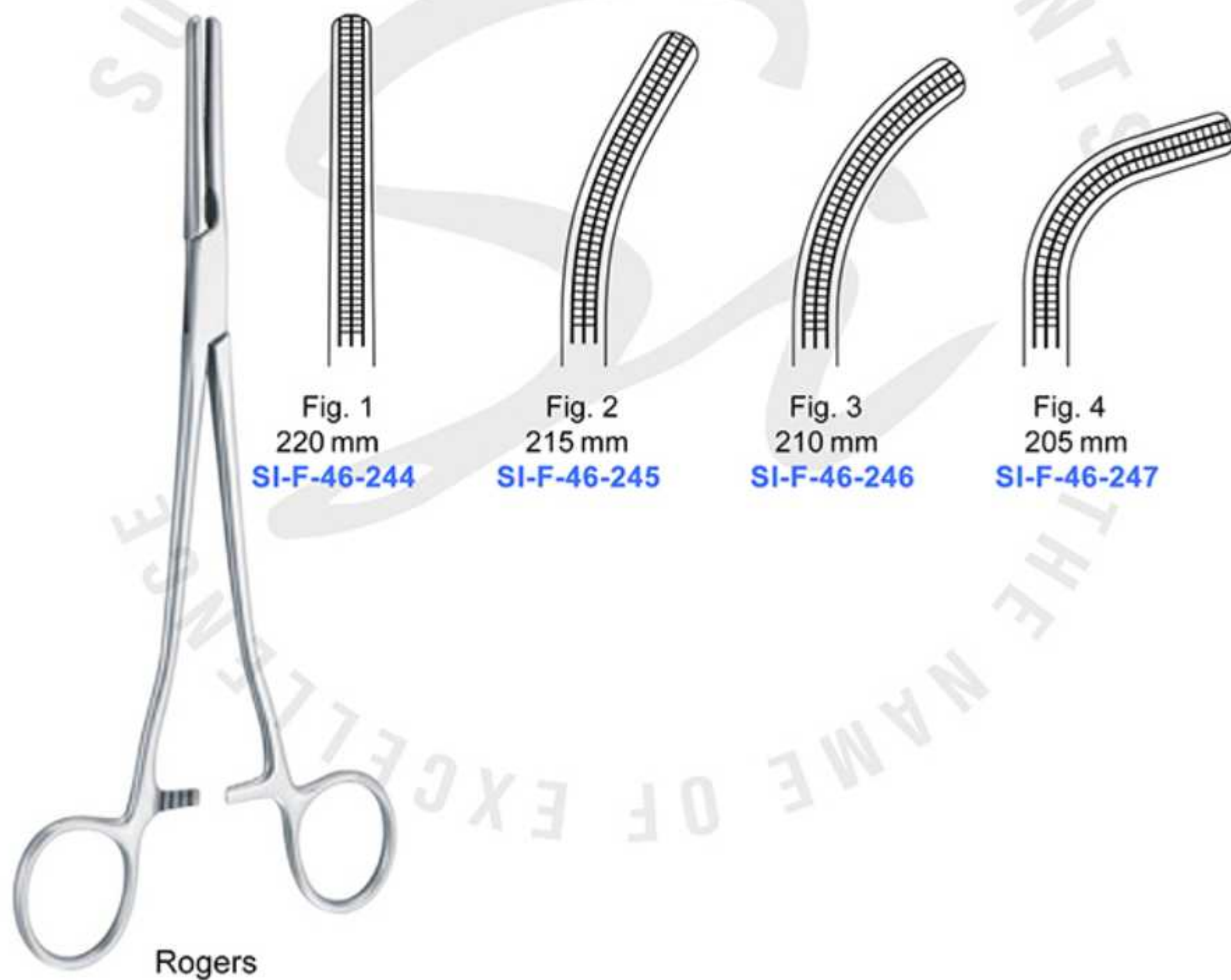

Pinces pour hystérectomie
Hysterectomy forceps
Pinzas para histerectomia
Pinze per isterectomia

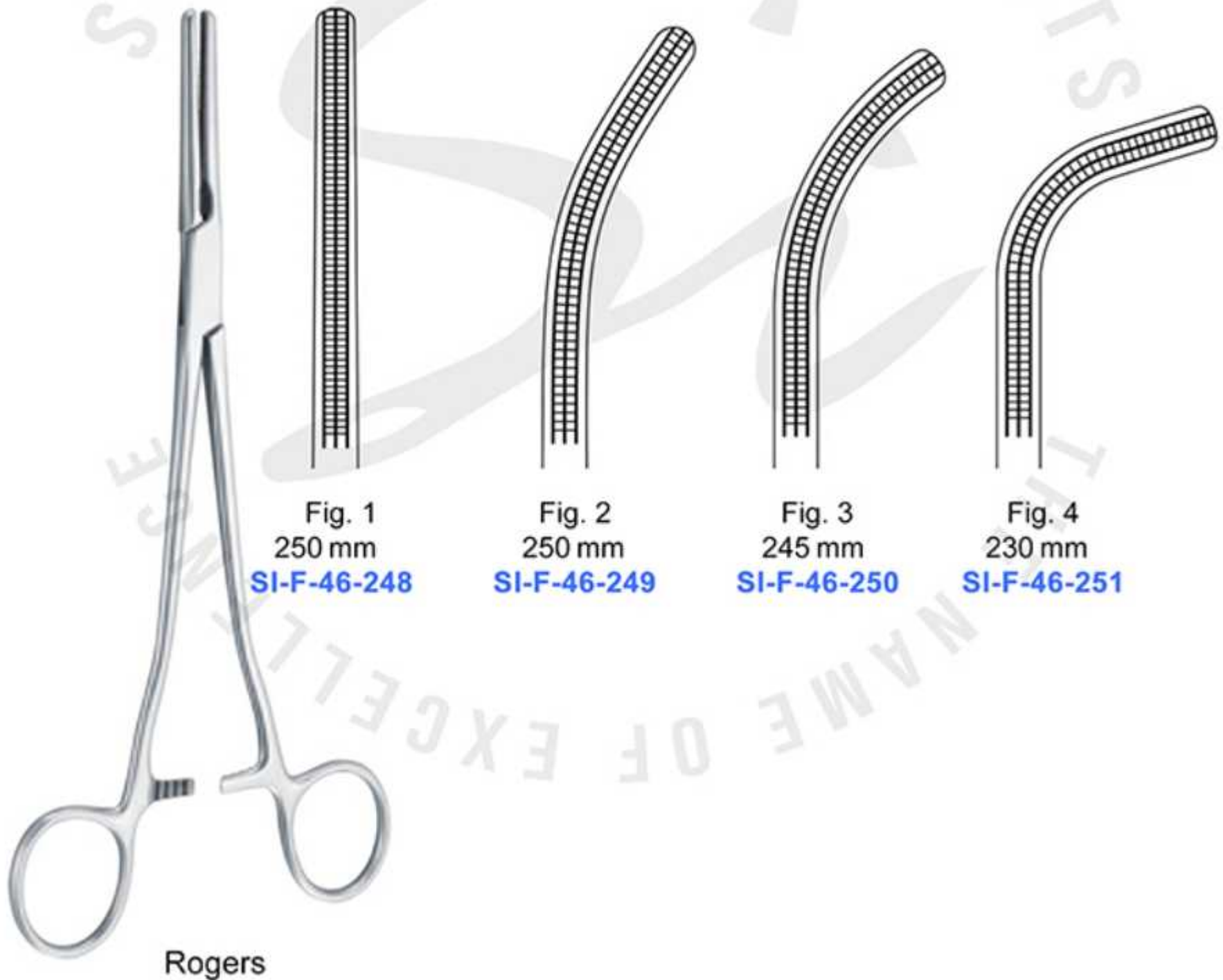

Pinces parametrium
Parametrium forceps
Pinzas parametrium
Pinze parametrium



210 mm
240 mm
300 mm
350 mm

SI-F-46-252
SI-F-46-252A
SI-F-46-252B
SI-F-46-252C



SI-F-46-253
SI-F-46-253A
SI-F-46-253B
SI-F-46-253C

SI-F-46-254
SI-F-46-254A
SI-F-46-254B
SI-F-46-254C

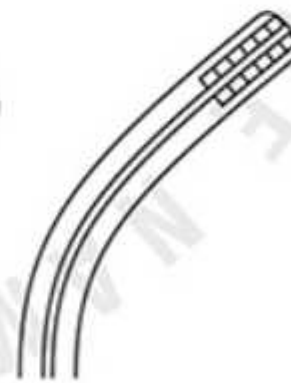
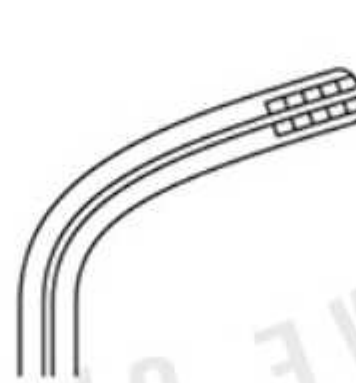

210 mm
240 mm
300 mm
350 mm

SI-F-46-255
SI-F-46-255A
SI-F-46-255B
SI-F-46-255C

SI-F-46-256
SI-F-46-256A
SI-F-46-256B
SI-F-46-256C

Pinces vasculaires et pour bronches
Bronchus- and vascular clamps
Pinzas vasculares y bronquiales
Pinze vascolari e per bronchi



Price-Thomas
220 mm – 8 3/4 "



SI-F-46-258
Pins left

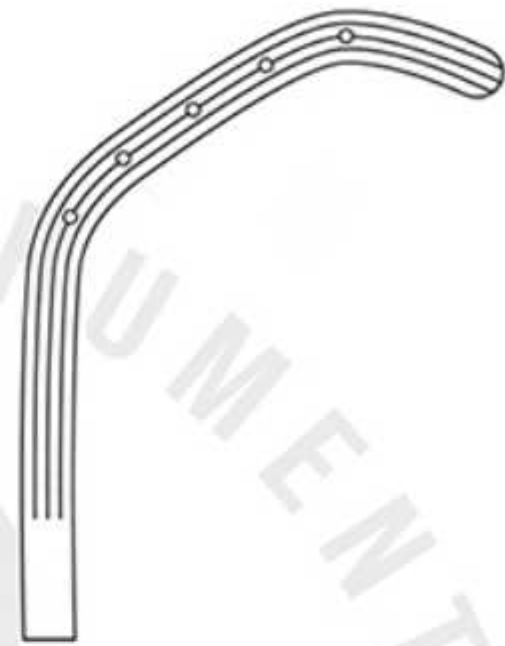

SI-F-46-259
Pins right



Price-Thomas
220 mm – 8 3/4 " **SI-F-46-257**

Pinces vasculaires et pour bronches
Bronchus- and vascular clamps
Pinzas vasculares y bronquiales
Pinze vascolari e per bronchi



Pinces vasculaires et pour bronches
Bronchus- and vascular clamps
Pinzas vasculares y bronquiales
Pinze vascolari e per bronchi



SI-F-46-262

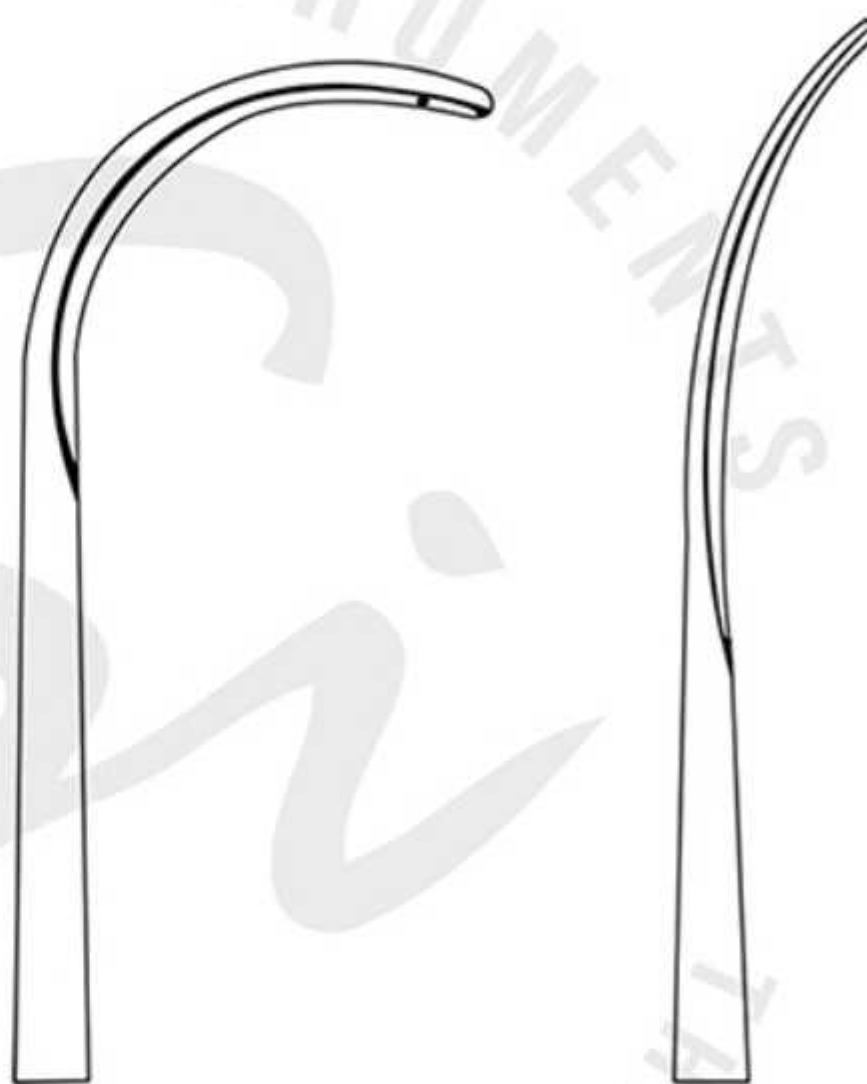

SI-F-46-263

Semb
240 mm – 9 1/2 "

Pinces vasculaires et pour bronches
Bronchus- and vascular clamps
Pinzas vasculares y bronquiales
Pinze vascolari e per bronchi



Satinsky
265 mm – 10 1/2"

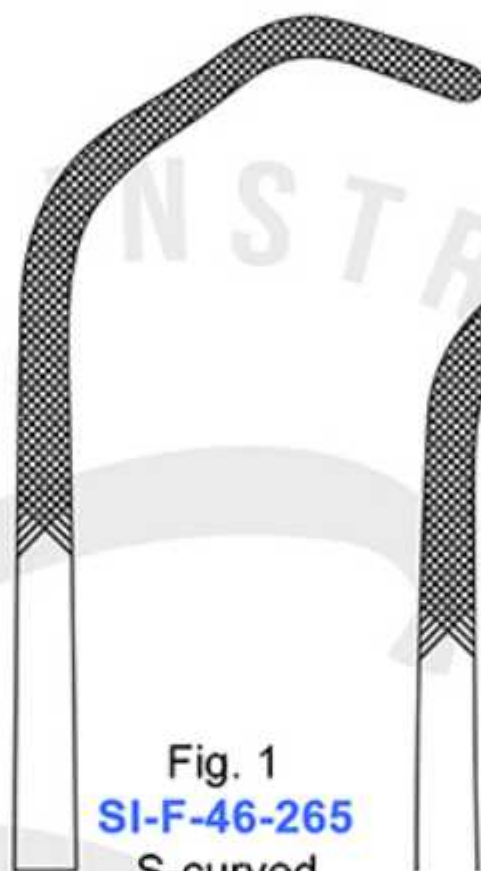

Fig. 1
SI-F-46-265
S-curved

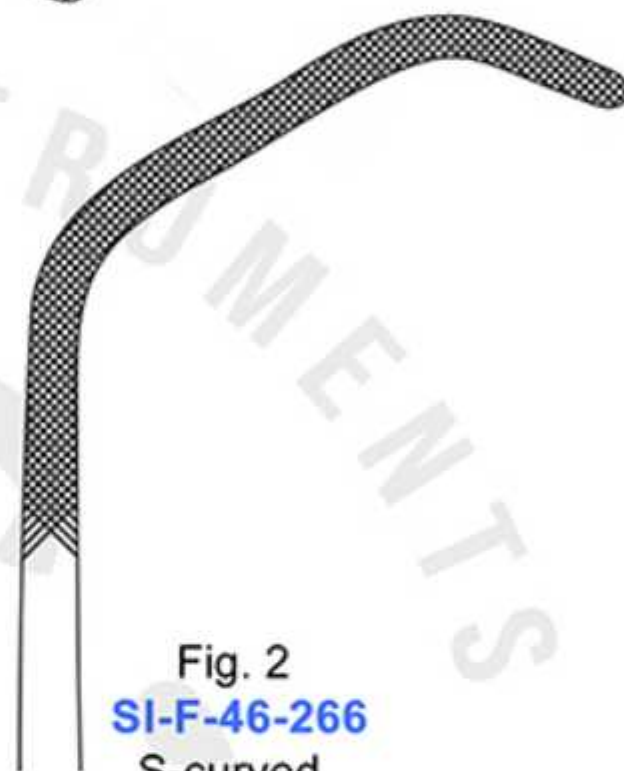

Fig. 2
SI-F-46-266
S-curved



Baby-Satinsky
150 mm – 6" **SI-F-46-264**

Pinces à champs
Towel forceps
Pinzas de campo
Pinze fissateli



Bernhard
100 mm – 4 "
120 mm – 4 3/4 "
140 mm – 5 1/2 "
165 mm – 6 1/2 "
180 mm – 7 "

SI-F-46-267
SI-F-46-267A
SI-F-46-267B
SI-F-46-267C
SI-F-46-267D



Roeder
130 mm – 5 "
150 mm – 6 "

SI-F-46-269
SI-F-46-269A



Backhaus
90 mm – 3 1/2 "
110 mm – 4 1/4 "
130 mm – 5 "
150 mm – 6 "

SI-F-46-268
SI-F-46-268A
SI-F-46-268B
SI-F-46-268C



Towel Forceps
110 mm – 4 "
SI-F-46-270
With clip for tube

Pinces à champs
Towel forceps
Pinzas de campo
Pinze fissateli



Robin
135 mm – 5 1/4 "
SI-F-46-271
with clip for tube up to 5mm Ø



Lane
130 mm – 5 " **SI-F-46-273**
150 mm – 6 " **SI-F-46-273A**
200 mm – 8 " **SI-F-46-273B**



Lorna
100 mm – 4 " **SI-F-46-272**
130 mm – 5 " **SI-F-46-272A**

Pinces à champs
Towel forceps
Pinzas de campo
Pinze fissateli



Tohoku-Japan
100 mm – 4 " **SI-F-46-274**
130 mm – 5 " **SI-F-46-274A**



Towel Forcep
90 mm – 3 1/2 " **SI-F-46-276**
115 mm – 4 1/2 " **SI-F-46-276A**
130 mm – 5 1/4 " **SI-F-46-276B**
For paper clothes



Peers-Bertram
145 mm – 5 3/4 " **SI-F-46-275**

Presse-tubes
Tubing clamps
Pinzas para tubos
Pinze serratubi



Tubing Clamp
150 mm – 6 " **SI-F-46-277**
160 mm – 6 1/4 " **SI-F-46-277A**
190 mm – 7 1/2 " **SI-F-46-277B**
240 mm – 9 1/2 " **SI-F-46-277C**



Tubing Clamp
150 mm – 6 " **SI-F-46-278**
160 mm – 6 1/4 " **SI-F-46-278A**
190 mm – 7 1/2 " **SI-F-46-278C**
With protection

Presse-tubes
Tubing clamps
Pinzas para tubos
Pinze serratubi



Tubing Clamp
165 mm – 6 1/2 " **SI-F-46-279**
180 mm – 7 " **SI-F-46-279A**



Klinikum-Berlin
145 mm – 5 3/4 "
SI-F-46-280
With extra long ratchet

Pinces à polypes et à pansements
Polypus and dressing forceps
Pinzas para pólipos y vendajes
Pinze per medicazione e polipi



Gross-Maier
200 mm – 8" **SI-F-47-01**
220 mm – 8 3/4" **SI-F-47-01A**
250 mm – 9 3/4" **SI-F-47-01B**
270 mm – 10 3/4" **SI-F-47-01C**
350 mm – 13 3/4" **SI-F-47-01D**



Gross-Maier
200 mm – 8" **SI-F-47-02**
220 mm – 8 3/4" **SI-F-47-02A**
250 mm – 9 3/4" **SI-F-47-02B**
270 mm – 10 3/4" **SI-F-47-02C**
350 mm – 13 3/4" **SI-F-47-02D**



Maier
200 mm – 8" **SI-F-47-03**
250 mm – 9 3/4" **SI-F-47-03A**

Pinces à polypes et à pansements
Polypus and dressing forceps
Pinzas para pólipos y vendajes
Pinze per medicazione e polipi



Maier
200 mm – 8 "
250 mm – 9 3/4 "

SI-F-47-04
SI-F-47-04A



Ulrich
220 mm – 8 3/4 "
250 mm – 9 3/4 "
270 mm – 10 3/4 "
350 mm – 14 "

SI-F-47-05
SI-F-47-05A
SI-F-47-05B
SI-F-47-05C



Ulrich
220 mm – 8 3/4 "
250 mm – 9 3/4 "
270 mm – 10 3/4 "
350 mm – 14 "

SI-F-47-06
SI-F-47-06A
SI-F-47-06B
SI-F-47-06C

Pinces à éponges
Sponge holding forceps
Pinzas para esponjas
Pinze per tamponi



Rampley
180 mm – 7 "
250 mm – 9 3/4 "

SI-F-47-07
SI-F-47-07A



Rampley
180 mm – 7 "
250 mm – 9 3/4 "

SI-F-47-08
SI-F-47-08A



Collin
250 mm – 9 3/4 " **SI-F-47-09**

Pinces à éponges
Sponge holding forceps
Pinzas para esponjas
Pinze per tamponi



Cheron
250 mm – 9 3/4 "
SI-F-47-10



Bergmann-Foerster
250 mm – 9 3/4 "
SI-F-47-11



Bergmann-Foerster
250 mm – 9 3/4 "
SI-F-47-12

Pinces à éponges
Sponge holding forceps
Pinzas para esponjas
Pinze per tamponi



Foerster (Ballenger)
180 mm – 7" **SI-F-47-13**
200 mm – 8" **SI-F-47-13A**
250 mm – 9 3/4" **SI-F-47-13B**
300 mm – 12" **SI-F-47-13C**
350 mm – 14" **SI-F-47-13D**
400 mm – 16" **SI-F-47-13E**



Foerster (Ballenger)
180 mm – 7" **SI-F-47-14**
200 mm – 8" **SI-F-47-14A**
250 mm – 9 3/4" **SI-F-47-14B**
300 mm – 12" **SI-F-47-14C**
350 mm – 14" **SI-F-47-14D**
400 mm – 16" **SI-F-47-14E**
Serrated

Pinces à éponges
Sponge holding forceps
Pinzas para esponjas
Pinze per tamponi



Foerster (Ballenger)
180 mm – 7" **SI-F-47-15**
200 mm – 8" **SI-F-47-15A**
250 mm – 9 3/4" **SI-F-47-15B**
300 mm – 12" **SI-F-47-15C**
350 mm – 14" **SI-F-47-15D**
400 mm – 16" **SI-F-47-15E**



Foerster (Ballenger)
180 mm – 7" **SI-F-47-16**
200 mm – 8" **SI-F-47-16A**
250 mm – 9 3/4" **SI-F-47-16B**
300 mm – 12" **SI-F-47-16C**
350 mm – 14" **SI-F-47-16D**
400 mm – 16" **SI-F-47-16E**
Serrated

Pinces à éponges
Sponge holding forceps
Pinzas para esponjas
Pinze per tamponi



Bozemann
260 mm – 10 1/4 "
SI-F-47-17
S-curved



Bozemann-Douglas
260 mm – 10 1/4 "
SI-F-47-18
S-curved

Pinces à éponges
Sponge holding forceps
Pinzas para esponjas
Pinze per tamponi



Pelkman
250 mm – 9 3/4 "
SI-F-47-19



Martin
170 mm – 6 3/4 " **SI-F-47-20**
255 mm – 10 " **SI-F-47-20A**



Martin
170 mm – 6 3/4 " **SI-F-47-21**
255 mm – 10 " **SI-F-47-21A**

Pinces à éponges
Sponge holding forceps
Pinzas para esponjas
Pinze per tamponi



Bryant
130 mm – 5"
SI-F-47-22

Lister (Sinus)
130 mm – 5"
160 mm – 6 1/4"
180 mm – 7"
Sinus forceps

SI-F-47-23
SI-F-47-23A
SI-F-47-23B



Duplay
200 mm – 8"
SI-F-47-24



Duplay
200 mm – 8"
SI-F-47-25

S*i* SURGICA
INSTRUMENTS
THE NAME OF EXCELLENCE



DRESSING AND DISSECTING FORCEPS

- DRESSING FORCEPS
- TISSUE FORCEPS
- EAR AND NOSE DRESSING FORCEPS
- IRIS FORCEPS
- GRASPING FORCEPS
- ATRAUMATIC TISSUE FORCEPS

Pinces à dissection
Dressing forceps
Pinzas de disección
Pinze anatomiche



Standard

- 105 mm – 4 1/4 "
- 115 mm – 4 1/2 "
- 130 mm – 5 "
- 145 mm – 5 3/4 "
- 150 mm – 6 "
- 160 mm – 6 1/4 "
- 180 mm – 7 "
- 200 mm – 8 "
- 250 mm – 10 "
- 300 mm – 12 "
- 350 mm – 14 "

- SI-DF-48-01
- SI-DF-48-01A
- SI-DF-48-01B
- SI-DF-48-01C
- SI-DF-48-01D
- SI-DF-48-01E
- SI-DF-48-01F
- SI-DF-48-01G
- SI-DF-48-01H
- SI-DF-48-01I
- SI-DF-48-01J

- SI-DF-48-02
- SI-DF-48-02A
- SI-DF-48-02B
- SI-DF-48-02C
- SI-DF-48-02D
- SI-DF-48-02E
- SI-DF-48-02F
- SI-DF-48-02G
- SI-DF-48-02H
- SI-DF-48-02I
- SI-DF-48-02J

- SI-DF-48-03
- SI-DF-48-03A
- SI-DF-48-03B
- SI-DF-48-03C
- SI-DF-48-03D
- SI-DF-48-03E
- SI-DF-48-03F
- SI-DF-48-03G
- SI-DF-48-03H
- SI-DF-48-03I
- SI-DF-48-03J

DRESSING FORCEPS

Pinces à dissection
Dressing forceps
Pinzas de disección
Pinze anatomiche



Mod. USA
120 mm – 4 3/4"
130 mm – 5"
145 mm – 5 3/4"
155 mm – 6"
180 mm – 7"
210 mm – 8 1/4"
250 mm – 9 3/4"
310 mm – 12 1/4"

SI-DF-48-04
SI-DF-48-04A
SI-DF-48-04B
SI-DF-48-04C
SI-DF-48-04D
SI-DF-48-04E
SI-DF-48-04F
SI-DF-48-04G

SI-DF-48-05
SI-DF-48-05A
SI-DF-48-05B
SI-DF-48-05C
SI-DF-48-05D
SI-DF-48-05E
SI-DF-48-05F
SI-DF-48-05G

Narrow

Dressing Forceps
130 mm – 5"
145 mm – 5 3/4"
160 mm – 6 1/4"
Cross Serated

SI-DF-48-06
SI-DF-48-06A
SI-DF-48-06B



Stille
150 mm – 6"
180 mm – 7"
200 mm – 8"

SI-DF-48-07
SI-DF-48-07A
SI-DF-48-07B



Semken
125 mm – 5"
150 mm – 6"

SI-DF-48-08
SI-DF-48-08A

Pinces à dissection
Dressing forceps
Pinzas de disección
Pinze anatomiche



Adson
120 mm – 4 3/4 "
150 mm – 6 "

SI-DF-48-09
SI-DF-48-09A



Micro-Adson
120 mm – 4 3/4 "
150 mm – 6 "

SI-DF-48-10
SI-DF-48-10A



Adson
120 mm – 4 3/4 "
SI-DF-48-11
Cross serrated



Hudson (Ewald)
120 mm – 4 3/4 "
SI-DF-48-12

Pinces à dissection
Dressing forceps
Pinzas de disección
Pinze anatomiche



Cushing
175 mm – 7"
SI-DF-48-13
Straight

Cushing
175 mm – 7"
SI-DF-48-14
Curved



Brophy
200 mm – 8"
SI-DF-48-16
Curved



Brophy
200 mm – 8"
SI-DF-48-15
Straight

Pinces à dissection
Dressing forceps
Pinzas de disección
Pinze anatomiche



Wangensteen
150 mm – 6"
230 mm – 9"

SI-DF-48-17

SI-DF-48-17A



Waugh

150 mm – 6"

200 mm – 8"

250 mm – 9 3/4"

SI-DF-48-18

SI-DF-48-18A

SI-DF-48-18B



Potts-Smith

180 mm – 7"

210 mm – 8 1/4"

250 mm – 9 3/4"

SI-DF-48-19

SI-DF-48-19A

SI-DF-48-19B



SI-DF-48-20

SI-DF-48-20A

SI-DF-48-20B

Pinces à dissection
Dressing forceps
Pinzas de disección
Pinze anatomiche



Taylor
175 mm – 7"
SI-DF-48-21



Gerald
180 mm – 7"
SI-DF-48-22
Straight



Gerald
180 mm – 7"
SI-DF-48-23
Curved



Gerald
180 mm – 7"
SI-DF-48-24
Angular

Pinces à dissection à griffes
Tissue forceps
Pinzas de disección con dientes
Pinze chirurgiche



Standard

105 mm	SI-DF-48-25	SI-DF-48-26	SI-DF-48-27	SI-DF-48-28	SI-DF-48-29
115 mm	SI-DF-48-25A	SI-DF-48-26A	SI-DF-48-27A	SI-DF-48-28A	SI-DF-48-29A
130 mm	SI-DF-48-25B	SI-DF-48-26B	SI-DF-48-27B	SI-DF-48-28B	SI-DF-48-29B
145 mm	SI-DF-48-25C	SI-DF-48-26C	SI-DF-48-27C	SI-DF-48-28C	SI-DF-48-29C
150 mm	SI-DF-48-25D	SI-DF-48-26D	SI-DF-48-27D	SI-DF-48-28D	SI-DF-48-29D
160 mm	SI-DF-48-25E	SI-DF-48-26E	SI-DF-48-27E	SI-DF-48-28E	SI-DF-48-29E
180 mm	SI-DF-48-25F	SI-DF-48-26F	SI-DF-48-27F	SI-DF-48-28F	SI-DF-48-29F
200 mm	SI-DF-48-25G	SI-DF-48-26G	SI-DF-48-27G	SI-DF-48-28G	SI-DF-48-29G
250 mm	SI-DF-48-25H	SI-DF-48-26H	SI-DF-48-27H	SI-DF-48-28H	SI-DF-48-29H
300 mm	SI-DF-48-25I	SI-DF-48-26I	SI-DF-48-27I	SI-DF-48-28I	SI-DF-48-29I
350 mm	SI-DF-48-25J	SI-DF-48-26J	SI-DF-48-27J	SI-DF-48-28J	SI-DF-48-29J

Narrow



Stille
150 mm – 6"

SI-DF-48-30



SI-DF-48-31

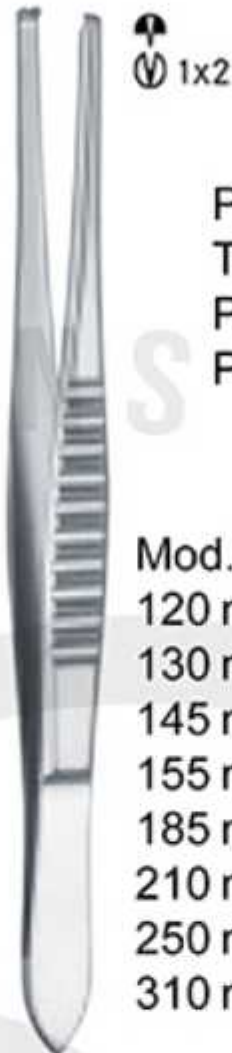

Mod. USA

120 mm – 4 3/4 "

130 mm – 5 "

145 mm – 5 3/4 "

155 mm – 6 "

185 mm – 7 "

210 mm – 8 "

250 mm – 9 3/4 "

310 mm – 12 1/4 "

SI-DF-48-32

SI-DF-48-32A

SI-DF-48-32B

SI-DF-48-32C

SI-DF-48-32D

SI-DF-48-32E

SI-DF-48-32F

SI-DF-48-32G

Pinces à dissection à griffes
Tissue forceps
Pinzas de disección con dientes
Pinze chirurgiche



Stone
150 mm – 6 "
SI-DF-48-33



Lerche
150 mm – 6 "
SI-DF-48-34

Pinces à dissection à griffes
Tissue forceps
Pinzas de disección con dientes
Pinze chirurgiche



Pinces à dissection à griffes
Tissue forceps
Pinzas de disección con dientes
Pinze chirurgiche



Adson-Graefe
120 mm – 4 3/4 "
SI-DF-48-43

Adson
120 mm – 4 3/4 "
150 mm – 6 "



SI-DF-48-41
SI-DF-48-41A



SI-DF-48-42
SI-DF-48-42A



Adson-Micro
120 mm – 4 3/4 "
150 mm – 6 "

SI-DF-48-44
SI-DF-48-44A



SI-DF-48-45
SI-DF-48-45A



AdsonBrown
120 mm – 4 3/4 "
SI-DF-48-46

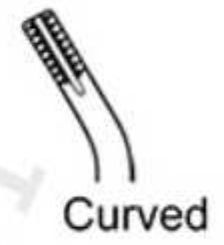

Pinces à dissection à griffes
Tissue forceps
Pinzas de disección con dientes
Pinze chirurgiche



Hudson (Ewald)
120 mm – 4 "
SI-DF-48-47



Adson
120 mm – 4 3/4 "
SI-DF-48-48



Ultra-Micro-Adson (Braka)
120 mm – 4 3/4 "
SI-DF-48-49



Gillies
150 mm – 6 "
SI-DF-48-50



Semken
125 mm – 5 " **SI-DF-48-51**
150 mm – 6 " **SI-DF-48-51A**



Duval
145 mm – 5 3/4 "
SI-DF-48-52

Pinces à dissection à griffes
Tissue forceps
Pinzas de disección con dientes
Pinze chirurgiche



Pinces à dissection à griffes
Tissue forceps
Pinzas de disección con dientes
Pinze chirurgiche



Lane
145 mm – 5 1/2 "
200 mm – 8 "

SI-DF-48-58
SI-DF-48-58A

SI-DF-48-59
SI-DF-48-59A

Brown
150 mm – 6 "
200 mm – 8 "
250 mm – 9 3/4 "

SI-DF-48-60
SI-DF-48-60A
SI-DF-48-60B

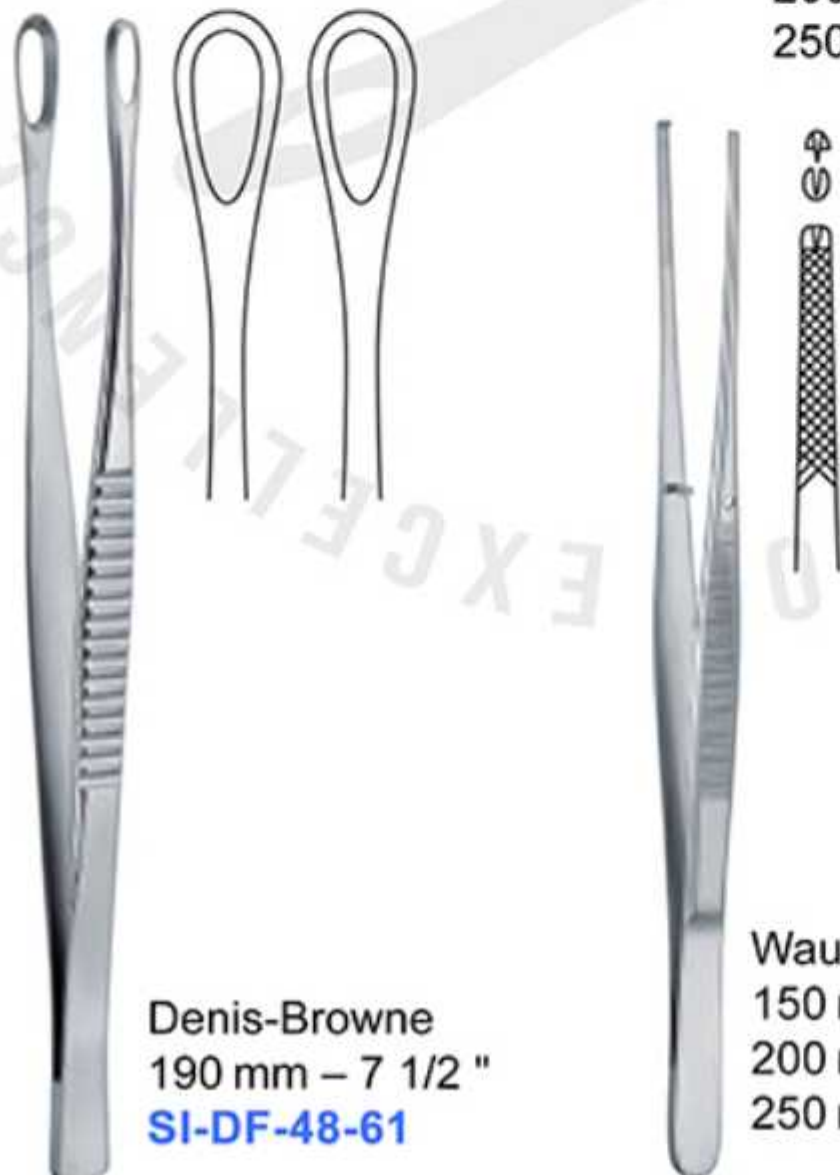

Denis-Browne
190 mm – 7 1/2 "
SI-DF-48-61

Waugh
150 mm – 6 "
200 mm – 8 "
250 mm – 9 3/4 "

SI-DF-48-62
SI-DF-48-62A
SI-DF-48-62B

Pinces à dissection à griffes
Tissue forceps
Pinzas de disección con dientes
Pinze chirurgiche



Taylor
175 mm SI-DF-48-64 SI-DF-48-64A SI-DF-48-64B

Stille-Barraya
180 mm – 7"
200 mm – 8"
250 mm – 9 3/4" SI-DF-48-63
SI-DF-48-63A
SI-DF-48-63B



Cushing
170 mm SI-DF-48-68 SI-DF-48-69

Gerald
170 mm SI-DF-48-65 SI-DF-48-66 SI-DF-48-67
180 mm SI-DF-48-65A SI-DF-48-66A SI-DF-48-67A

Pinces auriculaires et nasaux
Ear and nose dressing forceps
Pinzas auriculares y nasales
Pinze auricolari e nasali



Pinces à iridectomie
Iris forceps
Pinzas para Iris
Pinze per iridectomia



Graefe
105 mm

SI-DF-48-77 SI-DF-48-78 SI-DF-48-79 SI-DF-48-80 SI-DF-48-81 SI-DF-48-82

Pinces à iridectomie
Iris forceps
Pinzas para Iris
Pinze per iridectomia



Graefe
70 mm – 2 3/4"
0.7 mm
1.0 mm

SI-DF-48-83
SI-DF-48-83A

SI-DF-48-84
SI-DF-48-84A

SI-DF-48-85
SI-DF-48-85A

SI-DF-48-86
SI-DF-48-86A

Pinces à saisir
Grasping forceps
Pinzas para coger
Pinze da presa



Durante
145 mm – 5 3/4" **SI-DF-48-87**
160 mm – 6 1/4" **SI-DF-48-87A**
200 mm – 8" **SI-DF-48-87B**



Mayo-Russ.
230 mm – 9"
SI-DF-48-89



Russ. Modell
150 mm – 6" **SI-DF-48-88**
200 mm – 8" **SI-DF-48-88A**
250 mm – 9 3/4" **SI-DF-48-88B**
300 mm – 11 3/4" **SI-DF-48-88C**

Pinces à saisir
Grasping forceps
Pinzas para coger
Pinze da presa



Nelson
230 mm – 9"
SI-DF-48-90



Singley-Tuttle
180 mm – 7" **SI-DF-48-91**
230 mm – 9" **SI-DF-48-91A**
350 mm – 14" **SI-DF-48-91B**

Pinces à saisir
Grasping forceps
Pinzas para coger
Pinze da presa



Collin-Duval
200 mm – 8"
x = 14 mm
SI-DF-48-92



Collin-Duval
200 mm – 8"
x = 18 mm
SI-DF-48-93



Collin-Duval
200 mm – 8"
x = 27 mm
SI-DF-48-94

Pinces atraumatiques
Atraumatic tissue forceps
Pinzas de disección atraumáticas
Pinze per dissezione atraumatiche

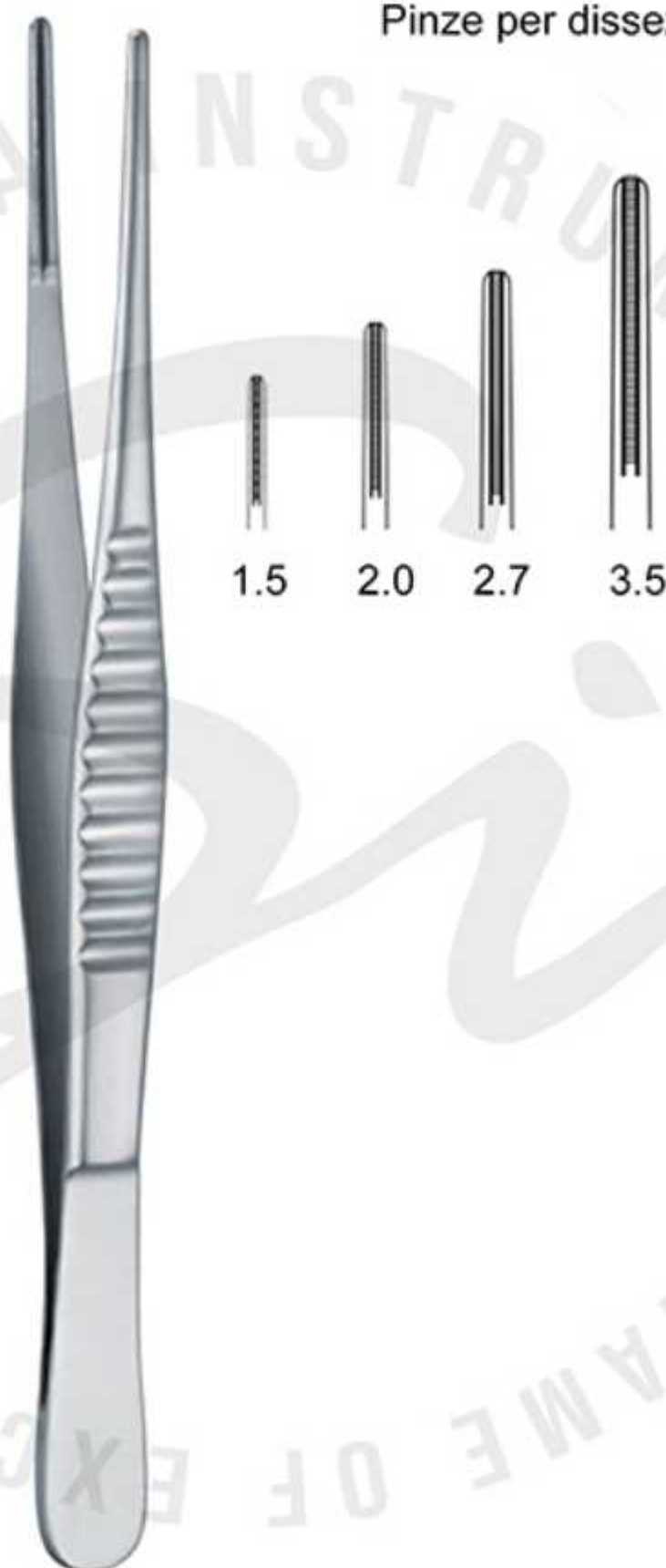

De Bakey

	x = 1.5 mm	x = 2.0 mm	x = 2.7 mm	x = 3.5 mm
120 mm	SI-DF-48-95	SI-DF-48-95A	SI-DF-48-95B	SI-DF-48-95C
145 mm	SI-DF-48-95D	SI-DF-48-95E	SI-DF-48-95F	SI-DF-48-95G
160 mm	SI-DF-48-95H	SI-DF-48-95I	SI-DF-48-95J	SI-DF-48-95K
200 mm	SI-DF-48-95L	SI-DF-48-95M	SI-DF-48-95N	SI-DF-48-95O
240 mm	SI-DF-48-95P	SI-DF-48-95Q	SI-DF-48-95R	SI-DF-48-95S
300 mm	SI-DF-48-95T	SI-DF-48-95U	SI-DF-48-95V	SI-DF-48-95W
350 mm	SI-DF-48-95X	SI-DF-48-95Y	SI-DF-48-95Z	SI-DF-48-95Aa

Pinces atraumatiques
Atraumatic tissue forceps
Pinzas de disección atraumáticas
Pinze per dissezione atraumatiche

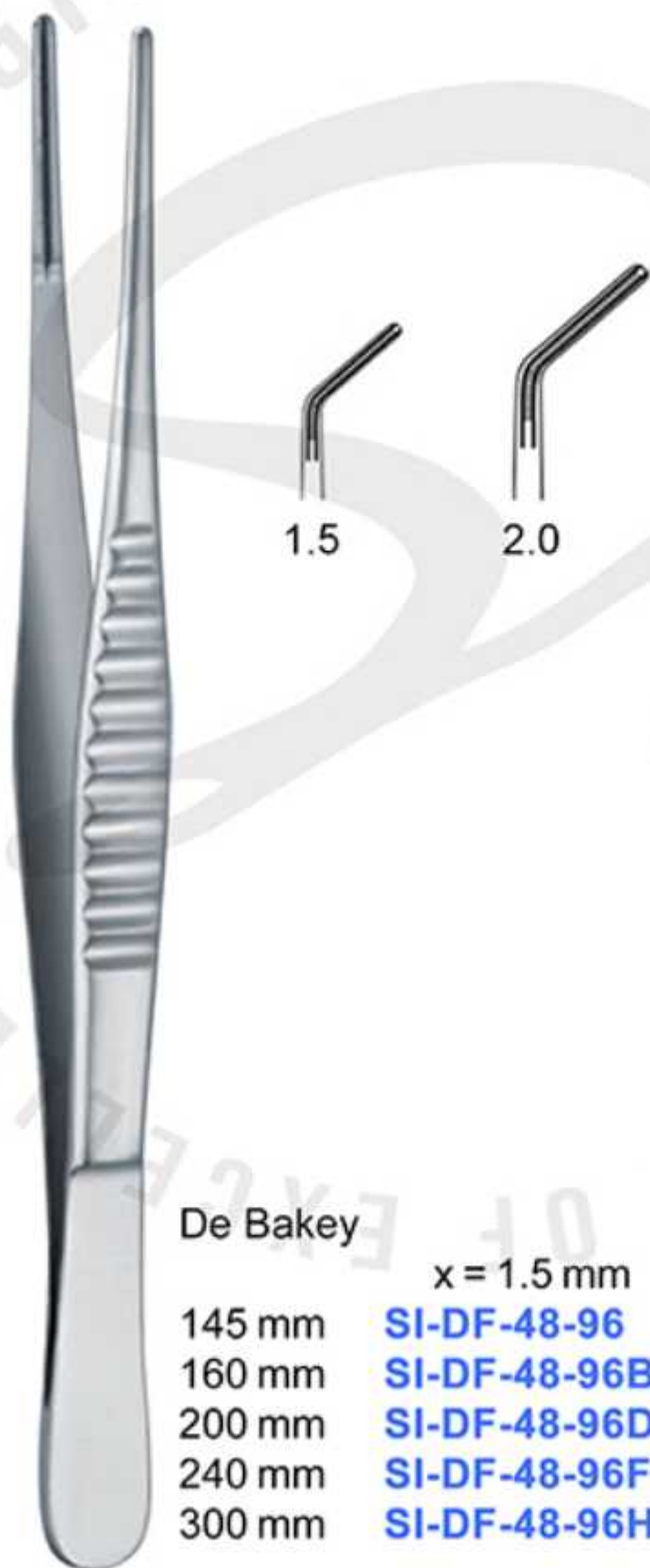

De Bakey

x = 1.5 mm

x = 2.0 mm

145 mm

SI-DF-48-96

SI-DF-48-96A

160 mm

SI-DF-48-96B

SI-DF-48-96C

200 mm

SI-DF-48-96D

SI-DF-48-96E

240 mm

SI-DF-48-96F

SI-DF-48-96G

300 mm

SI-DF-48-96H

SI-DF-48-96I

S*i* SURGICA
INSTRUMENTS
THE NAME OF EXCELLENCE



GYNECOLOGY INSTRUMENTS

- VAGINAL SPECULA
- UTERINE SOUNDS
- UTERINE DILATOR
- TENACULUM FORCEPS
- UTERINE SEIZING FORCEPS
- MYOMA INSTRUMENTS
- FISTULA HOOKS
- & MORE

Spéculum vaginal
Vaginal specula
Espéculos vaginales
Specoli vaginali



Standard Vaginal Specula

(1) Small

SI-786-4-101

(2) Medium

SI-786-4-101A

(3) Large

SI-786-4-101B



Cusco Vaginal Speculum with
Smoke Evacuation Tube

(1) Small

SI-786-4-102

(2) Medium

SI-786-4-102A

(3) Large

SI-786-4-102B



Cusco Vaginal Speculum with
Smoke Evacuation Tube

(1) Small

SI-786-4-103

(2) Medium

SI-786-4-103A

(3) Large

SI-786-4-103B



Cusco Vaginal Speculum

(1) 75 mm x 17 mm

SI-786-4-104

(2) 75 mm x 32 mm

SI-786-4-104A

(3) 85 mm x 35 mm

SI-786-4-104B

(4) 100 mm x 35 mm

SI-786-4-104C

Spéculums vaginaux
Vaginal specula
Espéculos vaginales
Specoli vaginali



Cusco Vaginal Speculum
75 mm x 32 mm
SI-786-4-105
85 mm x 35 mm
SI-786-4-105A
100 mm x 37 mm
SI-786-4-105B



Cusco Vaginal Speculum
80 mm x 22 mm
SI-786-4-106
100 mm x 25 mm
SI-786-4-106A
105 mm x 27 mm
SI-786-4-106B
Swiss pattern



Grave Vaginal Speculum
75 mm x 20 mm
SI-786-4-107
95 mm x 35 mm
SI-786-4-107A
115 mm x 35 mm
SI-786-4-107B

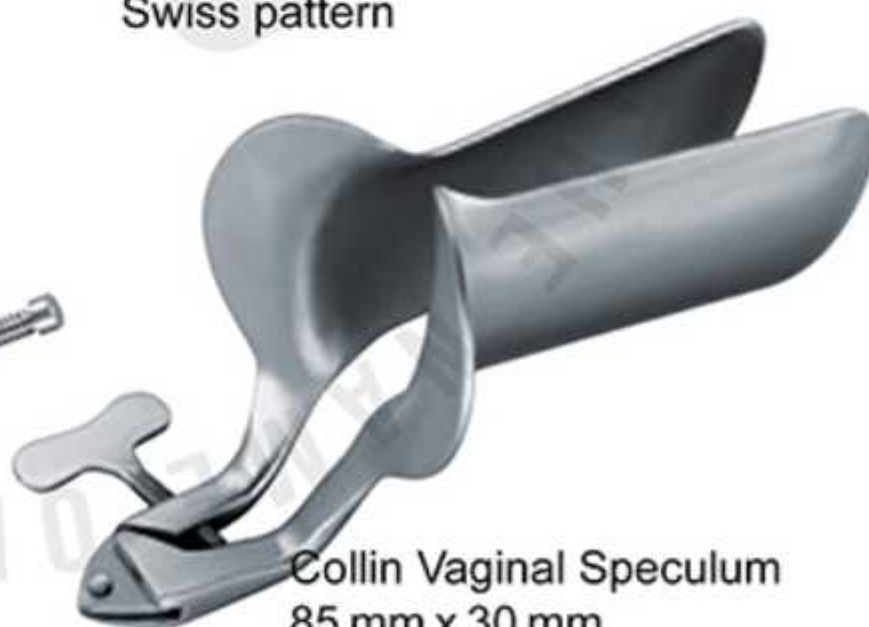

Collin Vaginal Speculum
85 mm x 30 mm
SI-786-4-108
100 mm x 35 mm
SI-786-4-108A
110 mm x 40 mm
SI-786-4-108B

Spéculums vaginaux
Vaginal specula
Espéculos vaginales
Specoli vaginali



Semm Vaginal Speculum
90 mm x 14 / 18 mm
SI-786-4-109
100 mm x 17 / 20 mm
SI-786-4-109A
100 mm x 25 / 30 mm
SI-786-4-109B



Trelat Vaginal speculum
85 mm x 30 mm
SI-786-4-110
95 mm x 35 mm
SI-786-4-110A
115 mm x 43 mm
SI-786-4-110B



Pederson Vaginal speculum
75 mm x 13 mm
SI-786-4-111
100 mm x 22 mm
SI-786-4-111A
120 mm x 25 mm
SI-786-4-111B

Spéculums vaginaux
Vaginal specula
Espéculos vaginales
Specoli vaginali



Kristeller Vaginal Speculum
70 x 27 mm **SI-786-4-112**
80 x 30 mm **SI-786-4-112A**
90 x 36 mm **SI-786-4-112B**
110 x 27 mm **SI-786-4-112C**
110 x 30 mm **SI-786-4-112D**
110 x 36 mm **SI-786-4-112E**



Kristeller Vaginal Retractor
75 x 23 mm **SI-786-4-113**
85 x 26 mm **SI-786-4-113A**
100 x 32 mm **SI-786-4-113B**
115 x 23 mm **SI-786-4-113C**
115 x 26 mm **SI-786-4-113D**
115 x 32 mm **SI-786-4-113E**



**Kristeller Vaginal Speculum
Retractor Set**
SI-786-4-114
SI-786-4-114A
SI-786-4-114B
SI-786-4-114C
SI-786-4-114D
SI-786-4-114E



Kristeller Vaginal Speculum
105 x 18 mm **SI-786-4-115**
105 x 21 mm **SI-786-4-115A**



Kristeller Vaginal Retractor
105 x 18 mm **SI-786-4-116**
105 x 21 mm **SI-786-4-116A**



Kristeller Vaginal Set
SI-786-4-117
SI-786-4-117A

Spéculums vaginaux
Vaginal specula
Espéculos vaginales
Specoli vaginali



Jackson Vaginal speculum
75 x 35 mm **SI-786-4-118**
75 x 40 mm **SI-786-4-118A**
90 x 35 mm **SI-786-4-118B**
90 x 40 mm **SI-786-4-118C**
100 x 35 mm **SI-786-4-118D**
100 x 40 mm **SI-786-4-118E**



Auvard Weighted
80 mm x 38 mm
220 mm – 8 3/4"
SI-786-4-119



Sims Vaginal speculum Set
60 x 25 mm / 30 mm
SI-786-4-120
70 x 30 mm / 35 mm
SI-786-4-120A
80 x 35 mm / 40 mm
SI-786-4-120B



Kallmorgen Vaginal speculum
70 x 40 mm **SI-786-4-121**
90 x 40 mm **SI-786-4-121A**



Kallmorgen Vaginal Retractor
70 x 33 mm **SI-786-4-122**
90 x 33 mm **SI-786-4-122A**



Kallmorgen Vaginal Set
SI-786-4-123
SI-786-4-123A

Spéculums vaginaux
Vaginal specula
Espéculos vaginales
Specoli vaginali



Breisky Vaginal speculum
320 mm – 12 3/4"
130 mm x 20 mm
SI-786-4-125
130 mm x 25 mm
SI-786-4-125A
130 mm x 30 mm
SI-786-4-125B
130 mm x 35 mm
SI-786-4-125C
130 mm x 40 mm
SI-786-4-125D



Breisky Vaginal speculum
300 mm – 12"
100 mm x 20 mm
SI-786-4-126
100 mm x 25 mm
SI-786-4-126A
100 mm x 30 mm
SI-786-4-126B
100 mm x 35 mm
SI-786-4-126C
100 mm x 40 mm
SI-786-4-126D

Landau Vaginal speculum
290 mm – 11 1/2"
100 mm x 28 mm
SI-786-4-124
110 mm x 38 mm
SI-786-4-124A



Breisky Vaginal speculum
350 mm – 13 3/4"
160 mm x 40 mm
SI-786-4-127
180 mm x 40 mm
SI-786-4-127A



Doyen Vaginal speculum
240 mm – 9 1/2"
55 mm x 35 mm
85 mm x 35 mm
115 mm x 35 mm
55 mm x 45 mm
85 mm x 45 mm
115 mm x 45 mm
160 mm x 45 mm
55 mm x 60 mm
85 mm x 60 mm
115 mm x 60 mm
160 mm x 60 mm

SI-786-4-128
SI-786-4-128A
SI-786-4-128B
SI-786-4-128C
SI-786-4-128D
SI-786-4-128E
SI-786-4-128F
SI-786-4-128G
SI-786-4-128H
SI-786-4-128I
SI-786-4-128J

Spéculums vaginaux
Vaginal specula
Espéculos vaginales
Specoli vaginali



Mathieu Vaginal Retractor speculum Set

Fig.1 95 x 13mm x100 x 11 mm

SI-786-41-128

Fig.2 95 x 16 mm x100 x 14 mm

SI-786-41-128A



Jayle Vaginal Retractor

60 x 40 mm

SI-786-41-131

90 x 40 mm

SI-786-41-131A



Doyen Lateral Vaginal Retractor

80 x 30 mm

SI-786-41-129

DOYEN LATERAL Vaginal Retractor

70 x 30 mm

SI-786-41-130

GYNECOLOGY INSTRUMENTS

Spéculums vaginaux
Vaginal specula
Espéculos vaginales
Specoli vaginali



Weissbarth Vaginal Speculum
80 x 42 mm
SI-786-41-132

Landon Vaginal Retractor
89 x 25 mm
SI-786-41-133

Tuebingen Vaginal Retractor
95 x 20 mm
SI-786-41-134

GYNECOLOGY INSTRUMENTS

Spéculums vaginaux
Vaginal specula
Espéculos vaginales
Specoli vaginali



Scherbak Vaginal Speculum Set
SI-786-41-135



80 x 30 mm



55 x 40 / 60 mm



85 x 35 mm

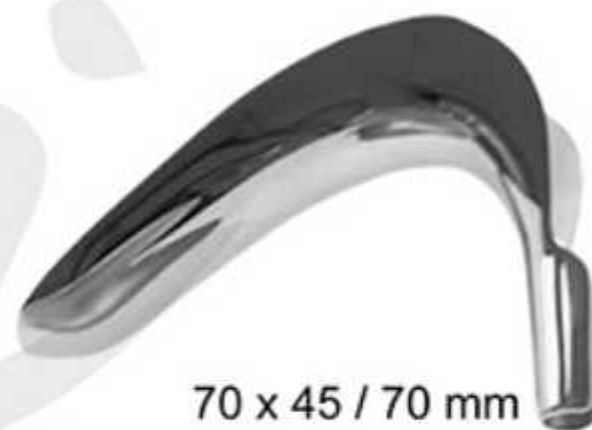

70 x 45 / 70 mm



90 x 40 mm



400 Gram
800 Gram

Spéculums vaginaux
Vaginal specula
Espéculos vaginales
Specoli vaginali



Bozemann Vaginal Speculum Set
23 cm
SI-786-41-136

Spéculums vaginaux
Vaginal specula
Espéculos vaginales
Specoli vaginali



Bozemann Vaginal Speculum Set
22 cm
SI-786-41-137

GYNECOLOGY INSTRUMENTS

Hystéromètres du col de l'utérus
Uterine sounds
Histerómetros uterinos
Isterometri uterini



Valleix
250 mm – 9 3/4"
SI-US-34-01
Graduated, with slider



Sims
33 cm - 13"
SI-US-34-02
Malleable



Sims
33 cm - 13"
SI-US-34-03
Rigid



Sims
33 cm - 13"
SI-US-34-04
Malleable, Silver Plated

Dilatateurs du col de l'utérus
Uterine Dilators
Dilatadores uterinos
Dilatatori uterini

Hegar Uterine Dilators
185 mm – 7 1/4 "

1.0 mm Ø	SI-786-4-129
2.0 mm Ø	SI-786-4-129A
3.0 mm Ø	SI-786-4-129B
4.0 mm Ø	SI-786-4-129C
5.0 mm Ø	SI-786-4-129D
6.0 mm Ø	SI-786-4-129E
7.0 mm Ø	SI-786-4-129F
8.0 mm Ø	SI-786-4-129G
9.0 mm Ø	SI-786-4-129H
10.0 mm Ø	SI-786-4-129I
11.0 mm Ø	SI-786-4-129J
12.0 mm Ø	SI-786-4-129K
13.0 mm Ø	SI-786-4-129L
14.0 mm Ø	SI-786-4-129M
15.0 mm Ø	SI-786-4-129N
16.0 mm Ø	SI-786-4-129O
17.0 mm Ø	SI-786-4-129P
18.0 mm Ø	SI-786-4-129Q
19.0 mm Ø	SI-786-4-129R
20.0 mm Ø	SI-786-4-129S
21.0 mm Ø	SI-786-4-129T
22.0 mm Ø	SI-786-4-129W
23.0 mm Ø	SI-786-4-129X
24.0 mm Ø	SI-786-4-129Y
25.0 mm Ø	SI-786-4-129Z
26.0 mm Ø	SI-786-4-129AA
27.0 mm Ø	SI-786-4-129AB
28.0 mm Ø	SI-786-4-129AC
29.0 mm Ø	SI-786-4-129AD
30.0 mm Ø	SI-786-4-129AE
31.0 mm Ø	SI-786-4-129AF
32.0 mm Ø	SI-786-4-129AG
33.0 mm Ø	SI-786-4-129AH
34.0 mm Ø	SI-786-4-129AI
35.0 mm Ø	SI-786-4-129AJ
36.0 mm Ø	SI-786-4-129AK

Hegar Uterine Dilators
185 mm – 7 1/4 "

1.5 mm Ø	SI-786-4-1219
2.5 mm Ø	SI-786-4-1219A
3.5 mm Ø	SI-786-4-1219B
4.5 mm Ø	SI-786-4-1219C
5.5 mm Ø	SI-786-4-1219D
6.5 mm Ø	SI-786-4-1219E
7.5 mm Ø	SI-786-4-1219F
8.5 mm Ø	SI-786-4-1219G
9.5 mm Ø	SI-786-4-1219H
10.5 mm Ø	SI-786-4-1219I
11.5 mm Ø	SI-786-4-1219J
12.5 mm Ø	SI-786-4-1219K
13.5 mm Ø	SI-786-4-1219L
14.5 mm Ø	SI-786-4-1219M
15.5 mm Ø	SI-786-4-1219N
16.5 mm Ø	SI-786-4-1219O
17.5 mm Ø	SI-786-4-1219P
18.5 mm Ø	SI-786-4-1219Q
19.5 mm Ø	SI-786-4-1219R
20.5 mm Ø	SI-786-4-1219S
21.5 mm Ø	SI-786-4-1219T
22.5 mm Ø	SI-786-4-1219W
23.5 mm Ø	SI-786-4-1219X
24.5 mm Ø	SI-786-4-1219Y
25.5 mm Ø	SI-786-4-1219Z
26.5 mm Ø	SI-786-4-1219AA



Dilatateurs du col de l'utérus
Uterine Dilators
Dilatadores uterinos
Dilatatori uterini



Hegar Uterine Dilators
200 mm - 8"

1 / 2 mm Ø	SI-786-4-130
3 / 4 mm Ø	SI-786-4-130A
5 / 6 mm Ø	SI-786-4-130B
7 / 8 mm Ø	SI-786-4-130C
9 / 10 mm Ø	SI-786-4-130D
11 / 12 mm Ø	SI-786-4-130E
13 / 14 mm Ø	SI-786-4-130F
15 / 16 mm Ø	SI-786-4-130G
17 / 18 mm Ø	SI-786-4-130H
19 / 20 mm Ø	SI-786-4-130I
21 / 22 mm Ø	SI-786-4-130J
23 / 24 mm Ø	SI-786-4-130K
25 / 26 mm Ø	SI-786-4-130L
27 / 28 mm Ø	SI-786-4-130M
29 / 30 mm Ø	SI-786-4-130N
31 / 32 mm Ø	SI-786-4-130O
33 / 34 mm Ø	SI-786-4-130P
35 / 36 mm Ø	SI-786-4-130Q



Hegar Uterine Dilators
200 mm - 8"
Set Of 13 Pcs
1 / 2 mm – 25 / 26 mm Ø
SI-786-5-132

Hegar Uterine Dilators
200 mm - 8"
Set Of 8 Pcs
3 / 4 mm – 17 / 18 mm Ø
SI-786-4-131

Dilatateurs du col de l'utérus
Uterine Dilators
Dilatadores uterinos
Dilatatori uterini



Hank Uterine Dilator
280 mm – 11 "
Set Of 6 Pcs
4.5 / 5 mm – 9.5 / 10 mm Ø

Fig 09/10	4.5 / 5.0 mm Ø	SI-786-4-132
Fig. 11/12	5.5 / 6.0 mm Ø	SI-786-4-132A
Fig. 13/14	6.5 / 7.0 mm Ø	SI-786-4-132B
Fig. 15/16	7.5 / 8.0 mm Ø	SI-786-4-132C
Fig. 17/18	8.5 / 9.0 mm Ø	SI-786-4-132D
Fig. 19/20	9.5 / 10.0 mm Ø	SI-786-4-132E

GYNECOLOGY INSTRUMENTS

Dilatateurs du col de l'utérus
Uterine Dilators
Dilatadores uterinos
Dilatatori uterini



Hegar Uterine Dilators
185 mm – 7 1/4 "
Set Of 14 Pcs
4 mm To 17 mm
SI-786-S-4-129

Hegar Uterine Dilators
185 mm – 7 1/4 "
Set Of 26 Pcs
1 mm To 26 mm
SI-786-S-4-130

Dilatateurs du col de l'utérus
Uterine Dilators
Dilatadores uterinos
Dilatatori uterini



Pratt Uterine Dilator Set
290 mm – 11 1/2"
13/15 mm To 41/43 mm
SI-786-SET-12

13/15 mm	SI-786-PD-4-12
17/19 mm	SI-786-PD-4-12A
21/23 mm	SI-786-PD-4-12B
25/27 mm	SI-786-PD-4-12C
29/31 mm	SI-786-PD-4-12D
33/35 mm	SI-786-PD-4-12E
37/39 mm	SI-786-PD-4-12F
41/43 mm	SI-786-PD-4-12G

Pinces pour l'abaissement du col de l'utérus
Tenaculum Forceps
Pinzas para coger el cuello del útero
Pinze per abbassare il collo dell'utero



Staude-Moore
170 mm – 6 3/4 "
SI-786-4-133



Barrett
180 mm – 7 "
SI-786-4-134



Skene
240 mm – 9 1/2 "
SI-786-4-135



Braun
250 mm – 9 3/4 "
SI-786-4-136



Pozzi
255 mm – 10 "
SI-786-4-137



SCHROEDER
250 mm – 9 3/4 "
SI-786-4-138

Pinces pour l'abaissement du col de l'utérus
Tenaculum Forceps
Pinzas para coger el cuello del útero
Pinze per abbassare il collo dell'utero



SCHROEDER
240 mm – 9 1/2 "
SI-786-4-139



Duplay
280 mm – 11 "
SI-786-4-141



Iova
260 mm – 10 1/4 "
SI-786-4-142



SCHROEDER
240 mm – 9 1/2 "
SI-786-4-140

Pinces hystérolabes
Uterine seizing forceps
Histerólabos
Pinze isterolabi



Dartigues
270 mm – 10 3/4 "
SI-USF-1-01



Somer
230 mm – 9 "
SI-USF-1-02



Collin
250 mm – 9 3/4 "
SI-USF-1-03

Instruments pour myomes
Myoma instruments
Instrumentos para fibroma
Strumenti per miomi

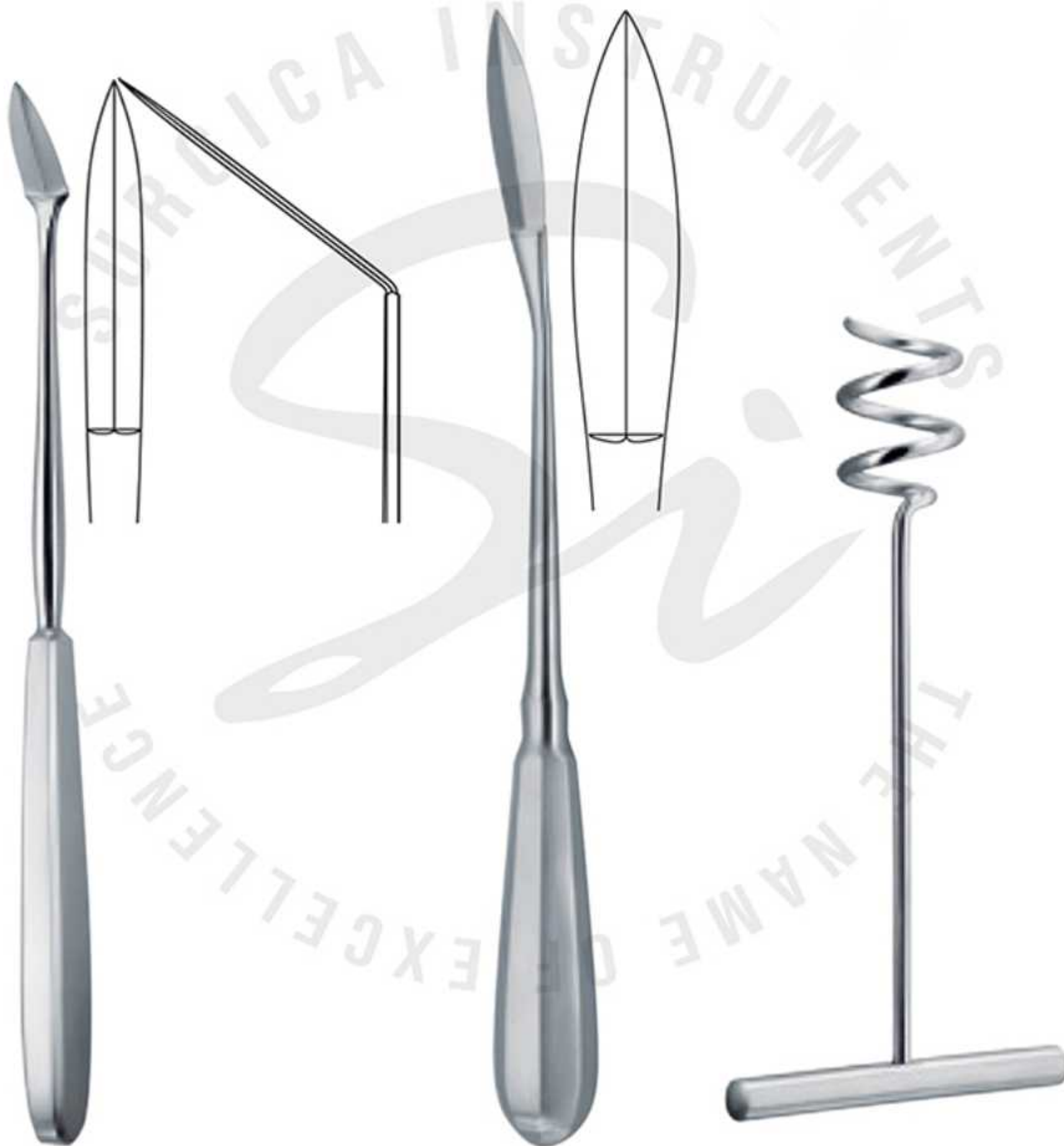

Ayre
230 mm – 9"
SI-MI-14-01

Segond
270 mm – 10 3/4"
SI-MI-14-02

Doyen
170 mm – 6 3/4"
SI-MI-14-03

Crochets pour fistules
Fistula hooks
Ganchos para fístulas
Uncini per fistole



Pinces emporte-pièces à biopsie
Cervical biopsy and specimen forceps
Pinzas saca-bocados para biopsia
Pinze taglianti per biopsia



Schubert
210 mm
280 mm

SI-CB-SF-01
SI-CB-SF-01A



Faure
210 mm – 8 1/2 "

SI-CB-SF-02



Schubert
260 mm – 10 1/4 "

SI-CB-SF-03

Pinces emporte-pièces à biopsie
Cervical biopsy and specimen forceps
Pinzas saca-bocados para biopsia
Pinze taglianti per biopsia



Gellhorn
230 mm – 9"
SI-CB-SF-04



Thoms-Gaylor
220 mm **SI-CB-SF-05**
240 mm **SI-CB-SF-05A**

Pinces emporte-pièces à biopsie
Cervical biopsy and specimen forceps
Pinzas saca-bocados para biopsia
Pinze taglianti per biopsia



Pinces emporte-pièces à biopsie
Cervical biopsy and specimen forceps
Pinzas saca-bocados para biopsia
Pinze taglianti per biopsia

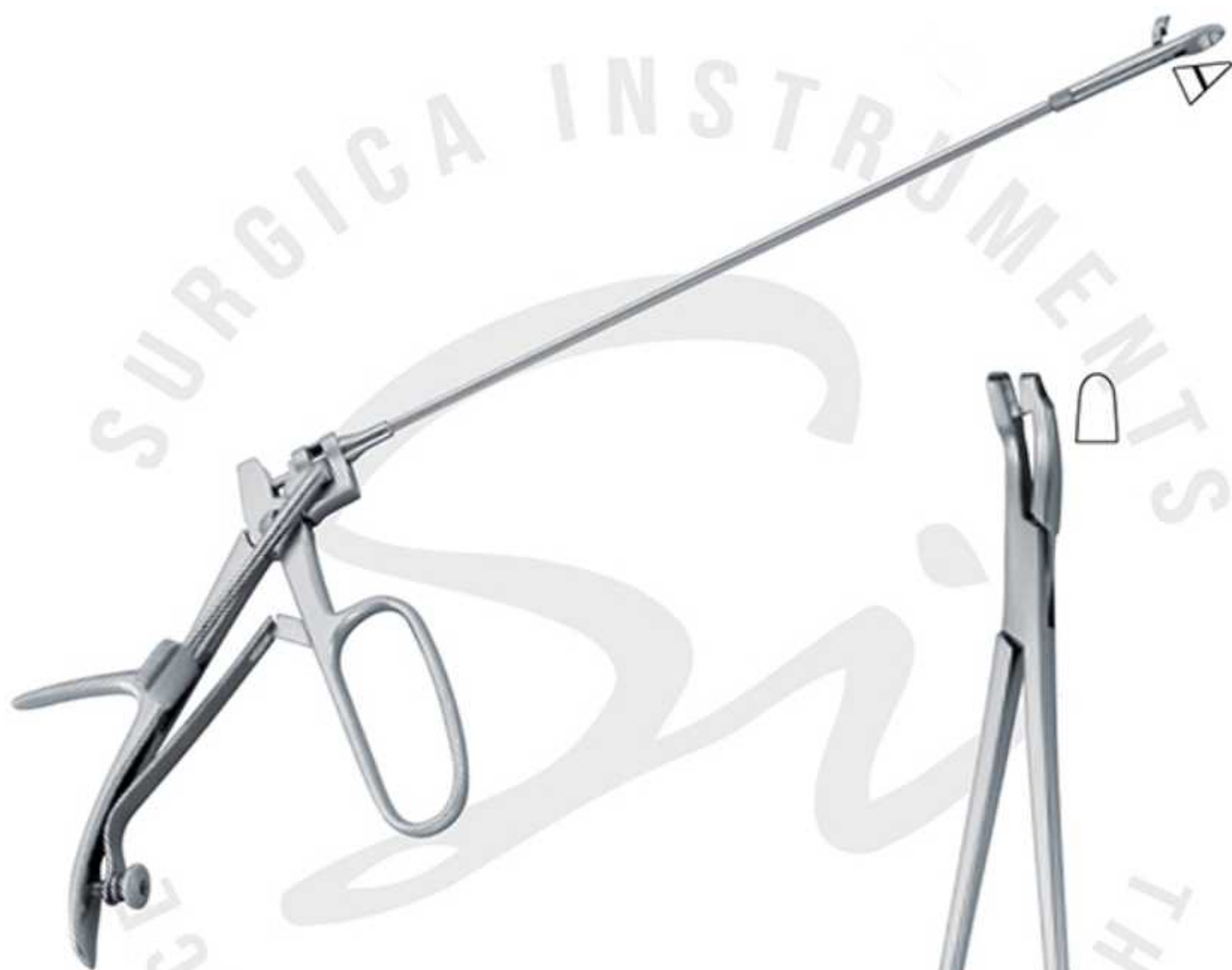

Schumacher
x = 230 mm – 9"
SI-CB-SF-09
Complete



Van Doren
240 mm – 9 1/2"
SI-CB-SF-10

Pinces emporte-pièces à biopsie
Cervical biopsy and specimen forceps
Pinzas saca-bocados para biopsia
Pinze taglianti per biopsia



Schumacher
Fig. 1
240 mm – 9 1/2"
SI-CB-SF-11



Schumacher
Fig. 2
240 mm – 9 1/2"
SI-CB-SF-12

Pinces emporte-pièces à biopsie
Cervical biopsy and specimen forceps
Pinzas saca-bocados para biopsia
Pinze taglianti per biopsia

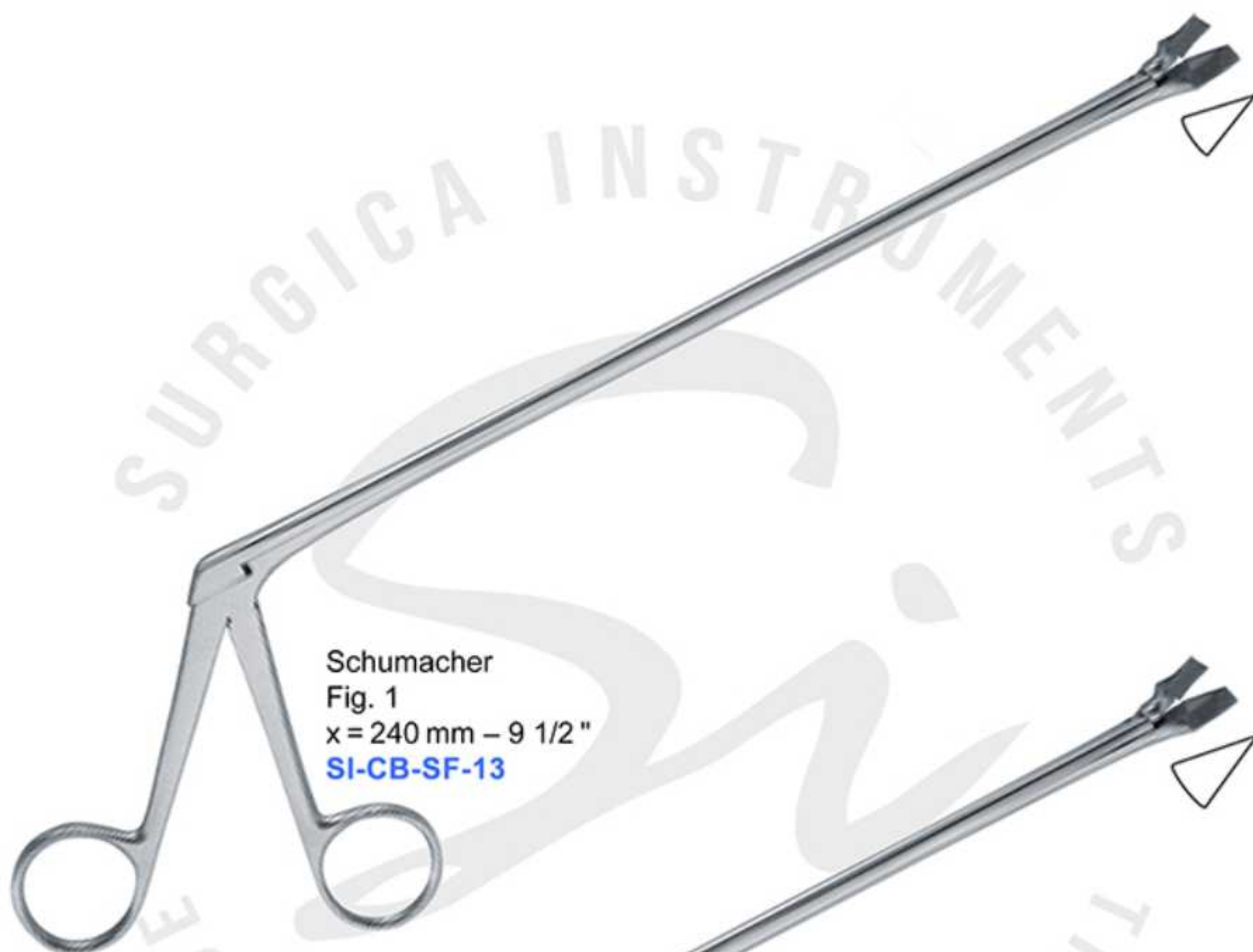

Schumacher
Fig. 1
x = 240 mm – 9 1/2 "
SI-CB-SF-13

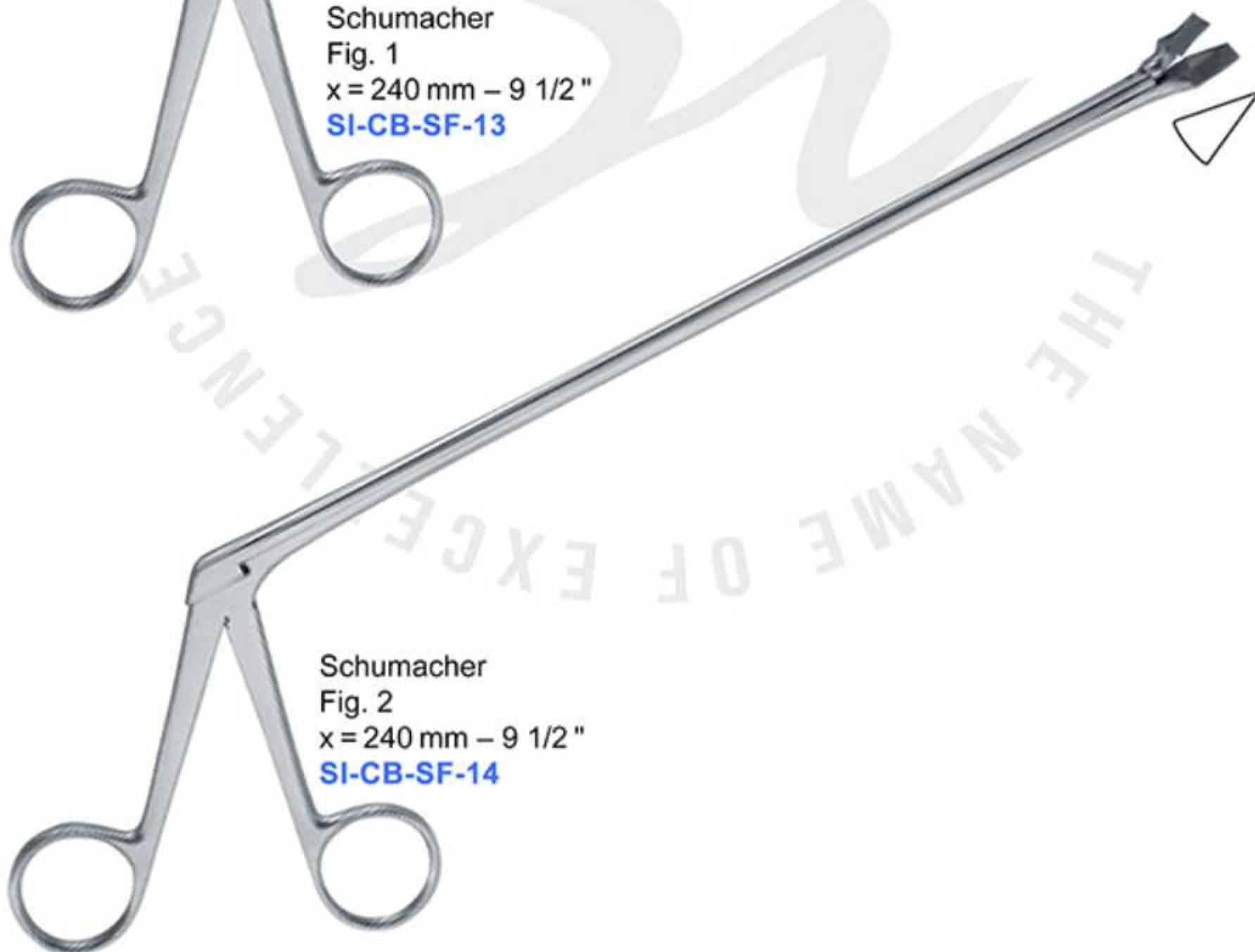

Schumacher
Fig. 2
x = 240 mm – 9 1/2 "
SI-CB-SF-14

Pinces emporte-pièces à biopsie
Cervical biopsy and specimen forceps
Pinzas saca-bocados para biopsia
Pinze taglianti per biopsia

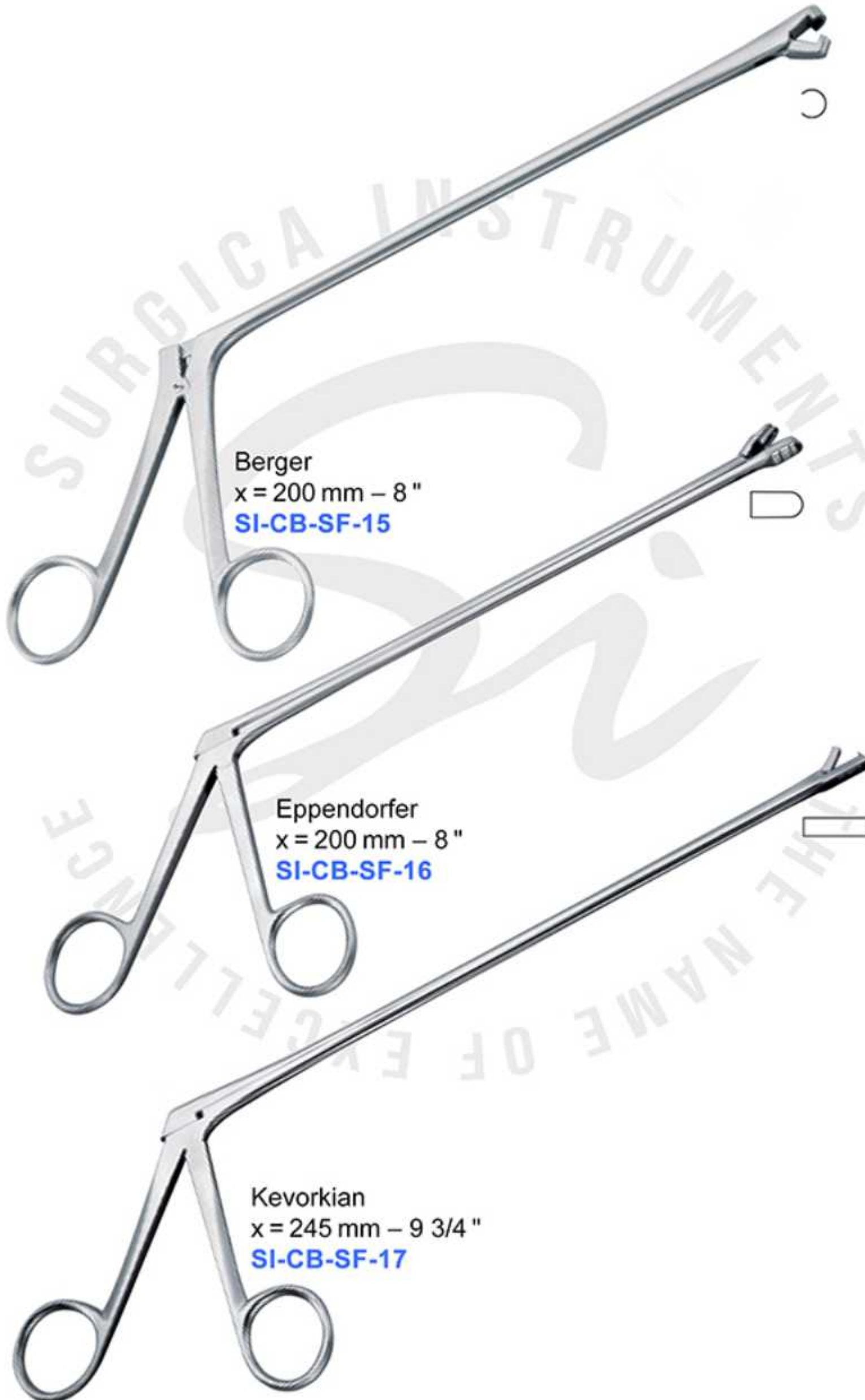

Pinces emporte-pièces à biopsie
Cervical biopsy and specimen forceps
Pinzas saca-bocados para biopsia
Pinze taglianti per biopsia



Tischler-Morgan
USA Modell
x = 200 mm **SI-CB-SF-18**
x = 250 mm **SI-CB-SF-18A**



Mini-Tischler
USA Modell
x = 200 mm **SI-CB-SF-19**
x = 250 mm **SI-CB-SF-19A**

Curettes de biopsie
Biopsy Curretes
Biopsie-Küretten
curetas de biopsia



Randall
240 mm - 9-1/2"
Diameter:
2 mm **SI-BC-15-01**
3 mm **SI-BC-15-01A**
4 mm **SI-BC-15-01B**



NOVAK
230 mm - 9"
Diameter:
2 mm **SI-BC-15-02**
3 mm **SI-BC-15-02A**
4 mm **SI-BC-15-02B**

GYNECOLOGY INSTRUMENTS

Curettes utérines Sharp, Malleable
Uterine curettes Blunt, Malleable
Curetas uterinas Sharp, Rigid
Curette uterine Blunt, Rigid



Curettes utérines Sharp, Malleable
Uterine curettes Blunt, Malleable
Curetas uterinas Sharp, Rigid
Curette uterine Blunt, Rigid

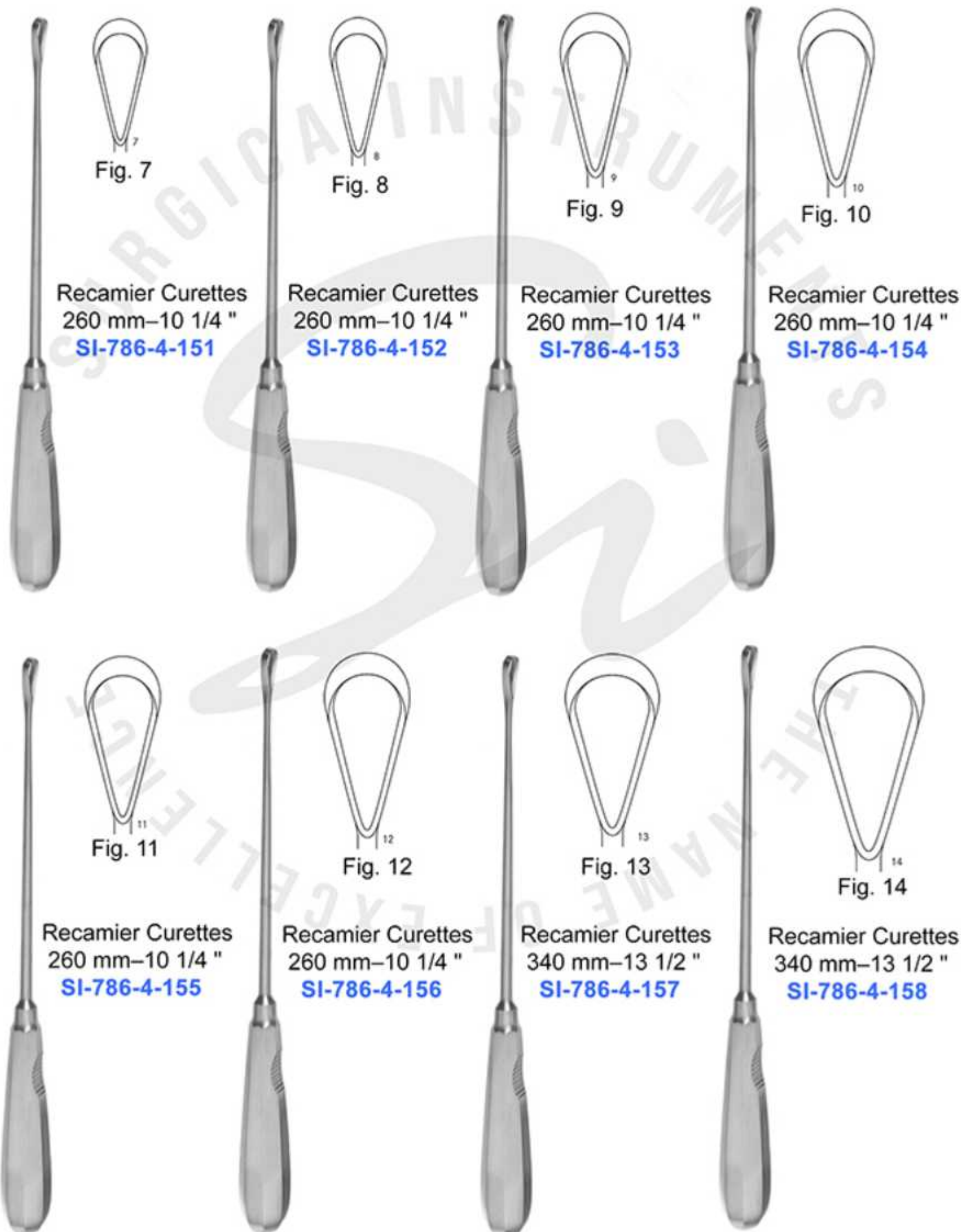

GYNECOLOGY INSTRUMENTS

Curettes utérines Sharp, Malleable
Uterine curettes Blunt, Malleable
Curetas uterinas Sharp, Rigid
Curette uterine Blunt, Rigid

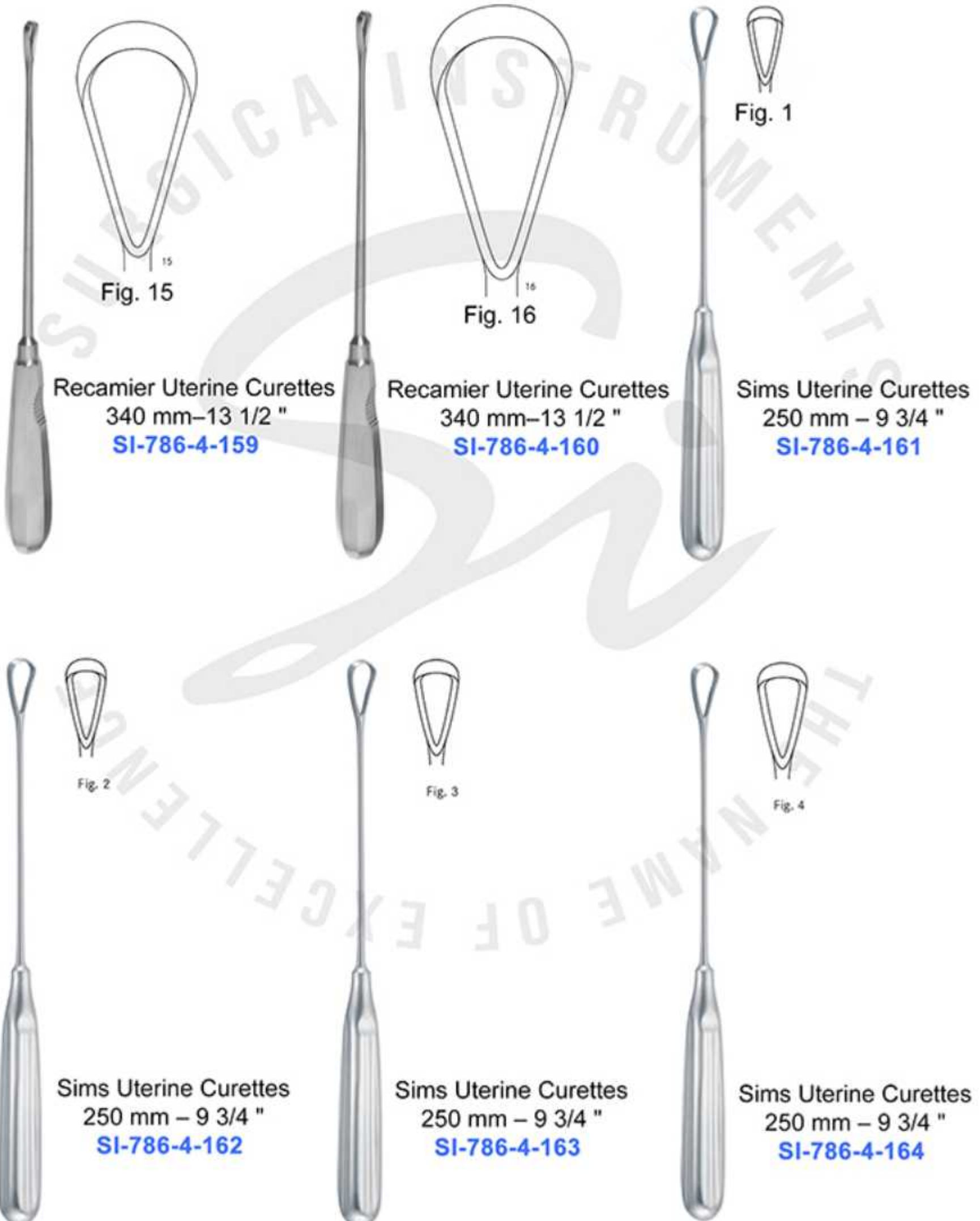

GYNECOLOGY INSTRUMENTS

Curettes utérines Sharp, Malleable
Uterine curettes Blunt, Malleable
Curetas uterinas Sharp, Rigid
Curette uterine Blunt, Rigid



Sims Uterine Curettes
250 mm – 9 3/4 "
SI-786-4-165



Sims Uterine Curettes
250 mm – 9 3/4 "
SI-786-4-166



Saenger Abortion Forceps
270 mm – 10 3/4 "
SI-786-4-167

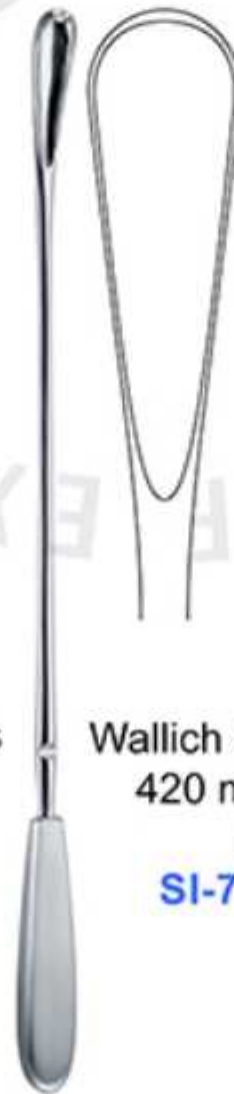

Wallich Ovum Curette
420 mm – 16 1/2 "
Blunt
SI-786-4-168



Pestaloza Ovum Curette
300 mm – 12 "
SI-786-4-169

Curettes tranchantes
Uterine spoons
Cucharillas cortantes
Cucchiai taglienti



Curettes tranchantes
Uterine spoons
Cucharillas cortantes
Cucchiai taglienti



Fig. 1

Schroder Uterine spoon
300 mm – 12 "
SI-786-4-176



Fig. 2

Schroder Uterine spoon
300 mm – 12 "
SI-786-4-177



Fig. 3

Schroder Uterine spoon
300 mm – 12 "
SI-786-4-178



Fig. 4

Schroder Uterine spoon
300 mm – 12 "
SI-786-4-179



Fig. 5

Schroder Uterine spoon
300 mm – 12 "
SI-786-4-180



Fig. 6

Schroder Uterine spoon
300 mm – 12 "
SI-786-4-181

Forceps obstétriques
Obstetrical forceps
Forceps obstétricos
Forcipi



Simpson obstetrical forceps
300 mm – 12"
SI-786-4-182



Simpson-Braun
330 mm – 13"
SI-786-4-183
360 mm – 14 1/4"
SI-786-4-183A



Naegele Obstetrical Forceps
360 mm – 14 1/4"
SI-786-4-184
400 mm – 16"
SI-786-4-184A



Piper Obstetrical Forceps
440 mm – 17 1/4"
SI-786-4-185

Forceps obstétriques
Obstetrical forceps
Forceps obstétricos
Forcipi



Wrigley Obstetrical Forceps
for caesarian section
230 mm – 9"
SI-786-4-187



Simpson-Luikart Obstetrical Forceps
360 mm – 14 1/4"
SI-786-4-186



DeLee Obstetrical Forceps
300 mm – 12"
SI-786-4-188



DeLee Obstetrical Forceps
360 mm – 14 1/4"
SI-786-4-189
390 mm – 15 1/2"
SI-786-4-189A

Forceps obstétriques
Obstetrical forceps
Forceps obstétricos
Forcipi



Elliot Obstetrical Forceps
320 mm – 12 1/2 "
SI-786-4-190
380 mm – 15 "
SI-786-4-190A



Mclean Obstetrical Forceps
360 mm – 14 1/4 "
SI-786-4-191



Kielland Obstetric Forceps
410 mm – 16 1/4 "
SI-786-4-192



KIELLAND-LUIKART
400 mm – 16 "
SI-786-4-193

Obstétrique
Obstetrics
Obstetricia
Ostetricia



Sellheim Obstetrical Lever
280 mm – 11 "
SI-786-4-194



Braun Decapitation Hook
325 mm – 12 3/4 "
SI-786-4-195



Green Armytage Uterine
Elevating Forceps
210 mm – 8 1/4 "
SI-786-4-196



Smellie's obstetrical perforator
250 mm – 10 "
SI-786-4-197

Obstétrique
Obstetrics
Obstetricia
Ostetricia



Braun Cranioclast one jaw fenestrated
420 mm – 16 1/2 "
SI-786-4-198



Tarnier Basiotribe
460 mm – 17 1/4 "
SI-786-4-199

Pinces à faux germes – Curette d'avortement
 Abortion forceps – Ovum curettes
 Pinzas para aborto – Curetas para aborto
 Pinze per placenta ed aborto – Curette per placenta ed aborto



Fig. 1

WINTER
280 mm – 11 "
SI-786-4-200



Fig. 2

WINTER
280 mm – 11 "
SI-786-4-201



Fig. 3

WINTER
280 mm – 11 "
SI-786-4-202

Pinces à faux germes – Curette d'avortement
 Abortion forceps – Ovum curettes
 Pinzas para aborto – Curetas para aborto
 Pinze per placenta ed aborto – Curette per placenta ed aborto



Canules d'insufflation à cône métallique Provis
Provis Metal Cone Insufflation Cannulas
Provis Metallkegel-Insufflationskanülen
Cánulas de insuflación de cono metálico Provis



Spackman
12 Fg. 4 mm
37.5 cm – 14 3/4"
SI-786-8-206



LEECH WILKINSON
Small 10 x 25 mm
SI-786-8-207
Medium 13 x 30 mm
SI-786-8-207A
Large 16 x 30 mm
SI-786-8-207B



Spackman
12 Fg. 4 mm
37.5 cm – 14 3/4"
SI-786-8-208

Clamps pour le cordon ombilical
Umbilical cord clamps
Clamps umbilicales
Pinze ombelicali

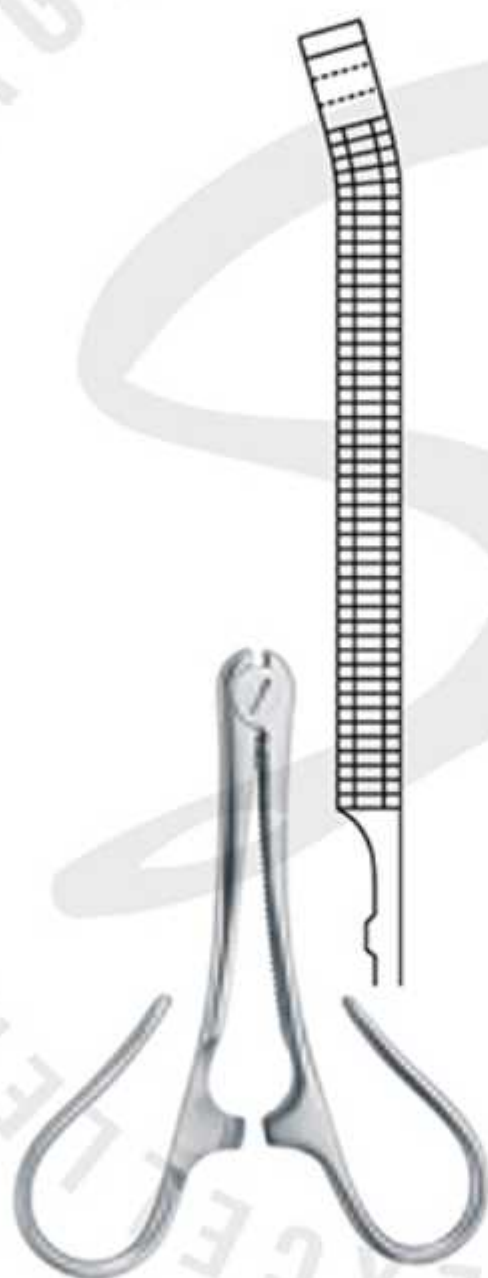

Kane
85 mm – 3 1/4 "
SI-UCC-01



Collin
90 mm – 3 1/2 "
SI-UCC-02

Pelvimètres
Pelvimeters
Pelvimetros
Pelvimetri



Martin
340 mm – 13 1/2 "
SI-P-15-01
cm / inch-scale



Collin
350 mm – 13 3/4 "
SI-P-15-02
cm-scale

Si **SURGICA**
INSTRUMENTS
THE NAME OF EXCELLENCE



UROLOGY INSTRUMENTS

- GALL DUCT DILATORS
- KIDNEY STONE FORCEPS
- GALL STONE SCOOPS
- GALL STONE FORCEPS
- PROSTATIC RETRACTORS
- PROSTATECTOMY FORCEPS
- BLADDER RETRACTORS
- & MORE

Instruments pour calculs biliaires
Gall stone instruments
Instrumental para coger cálculos biliares
Strumenti per canali bilari



Fig. 1
SI-786-3-294



Fig. 2
SI-786-3-295



Fig. 3
SI-786-3-296



Fig. 4
SI-786-3-297

Bakes Gall Duck Dilators 300 mm – 12 " Malleable



Fig. 5
SI-786-3-298

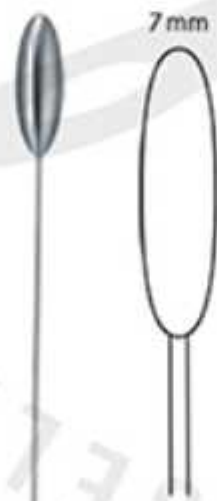

Fig. 6
SI-786-3-299

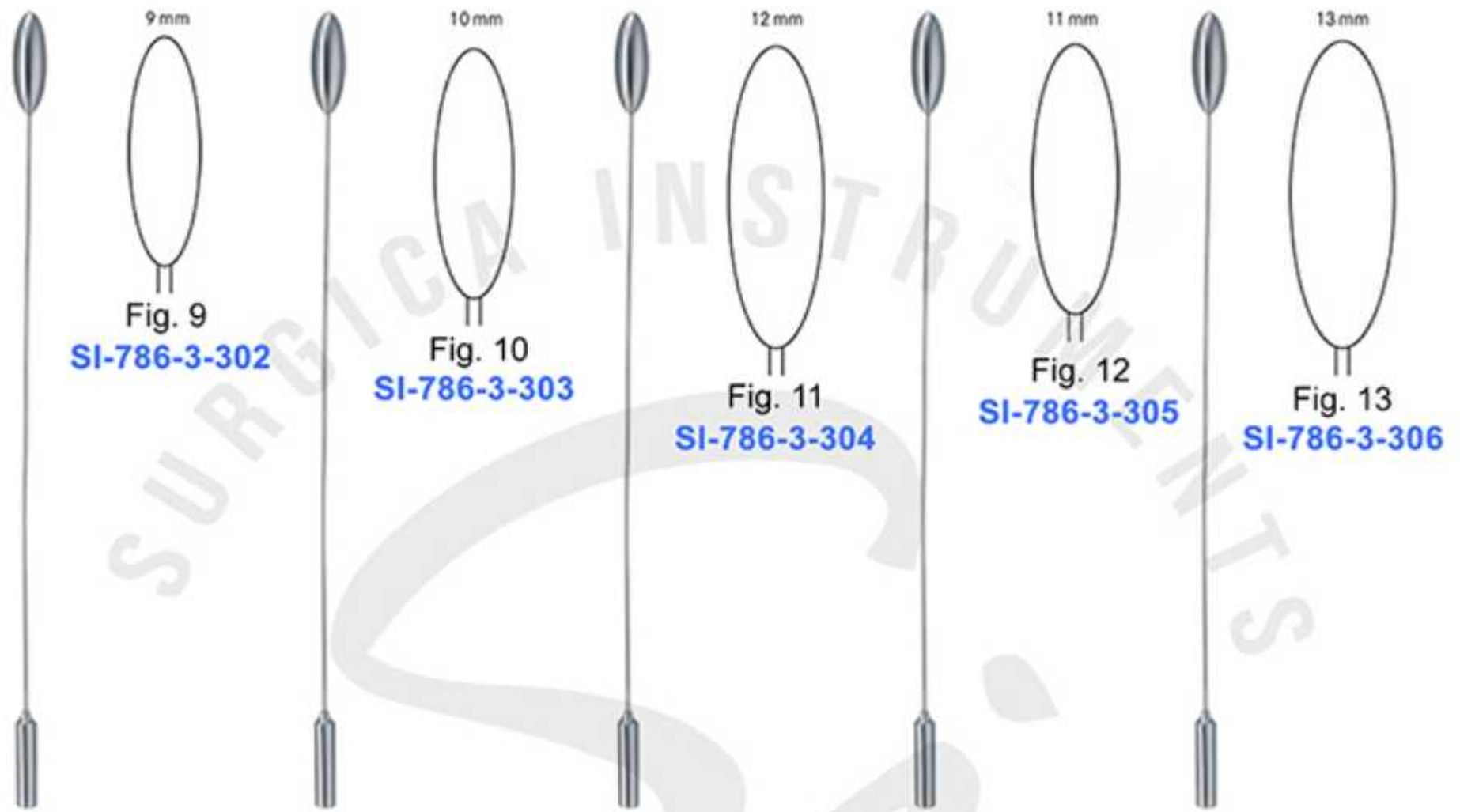

Fig. 7
SI-786-3-300

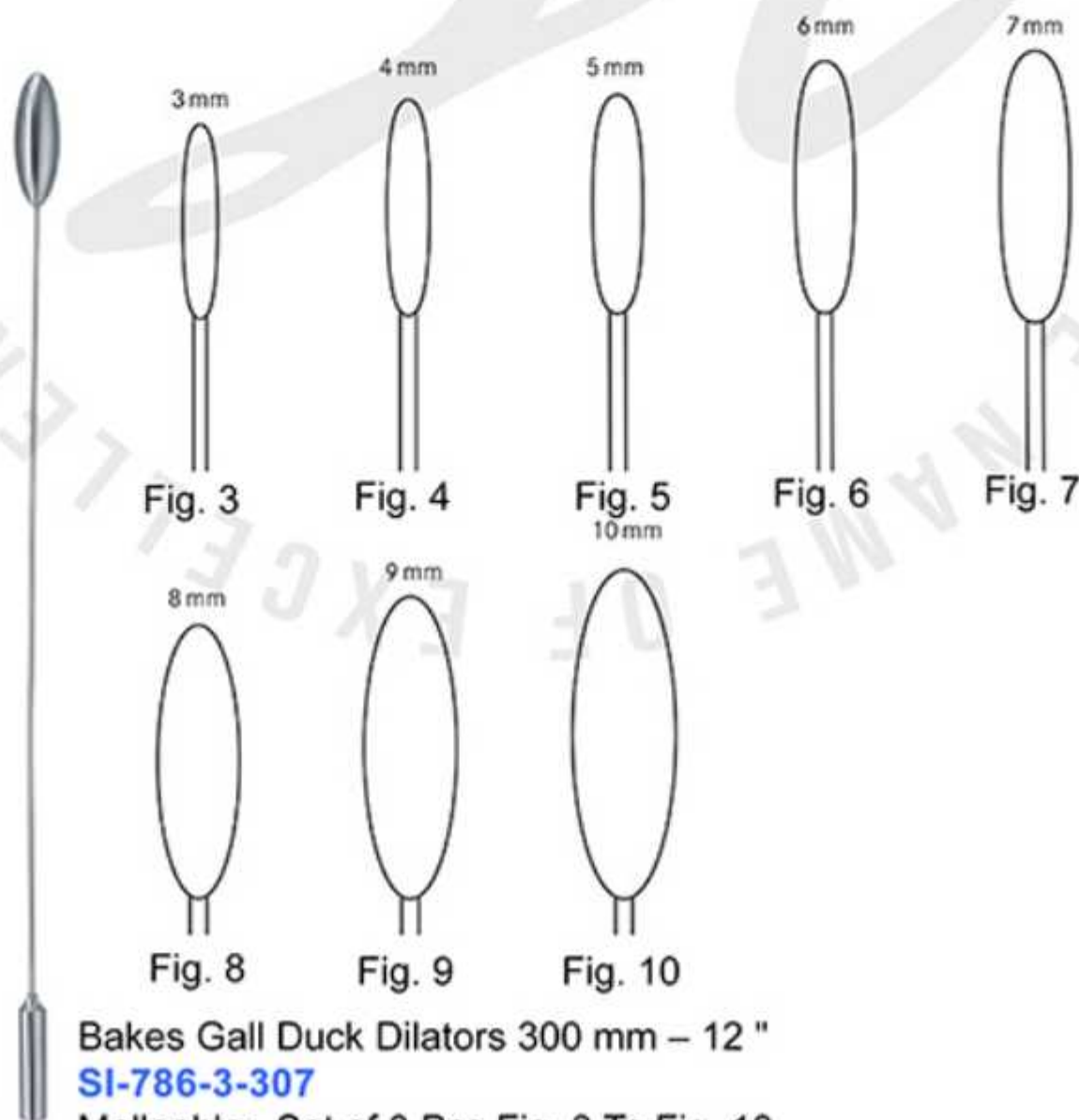

Fig. 8
SI-786-3-301

Instruments pour calculs biliaires
Gall stone instruments
Instrumental para coger cálculos biliares
Strumenti per canali bilari



Bakes Gall Duck Dilators 300 mm – 12 "
Malleable



Bakes Gall Duck Dilators 300 mm – 12 "
SI-786-3-307
Malleable: Set of 8 Pcs Fig. 3 To Fig. 10

Instruments pour calculs biliaires
Gall stone instruments
Instrumental para coger cálculos biliares
Strumenti per canali bilari

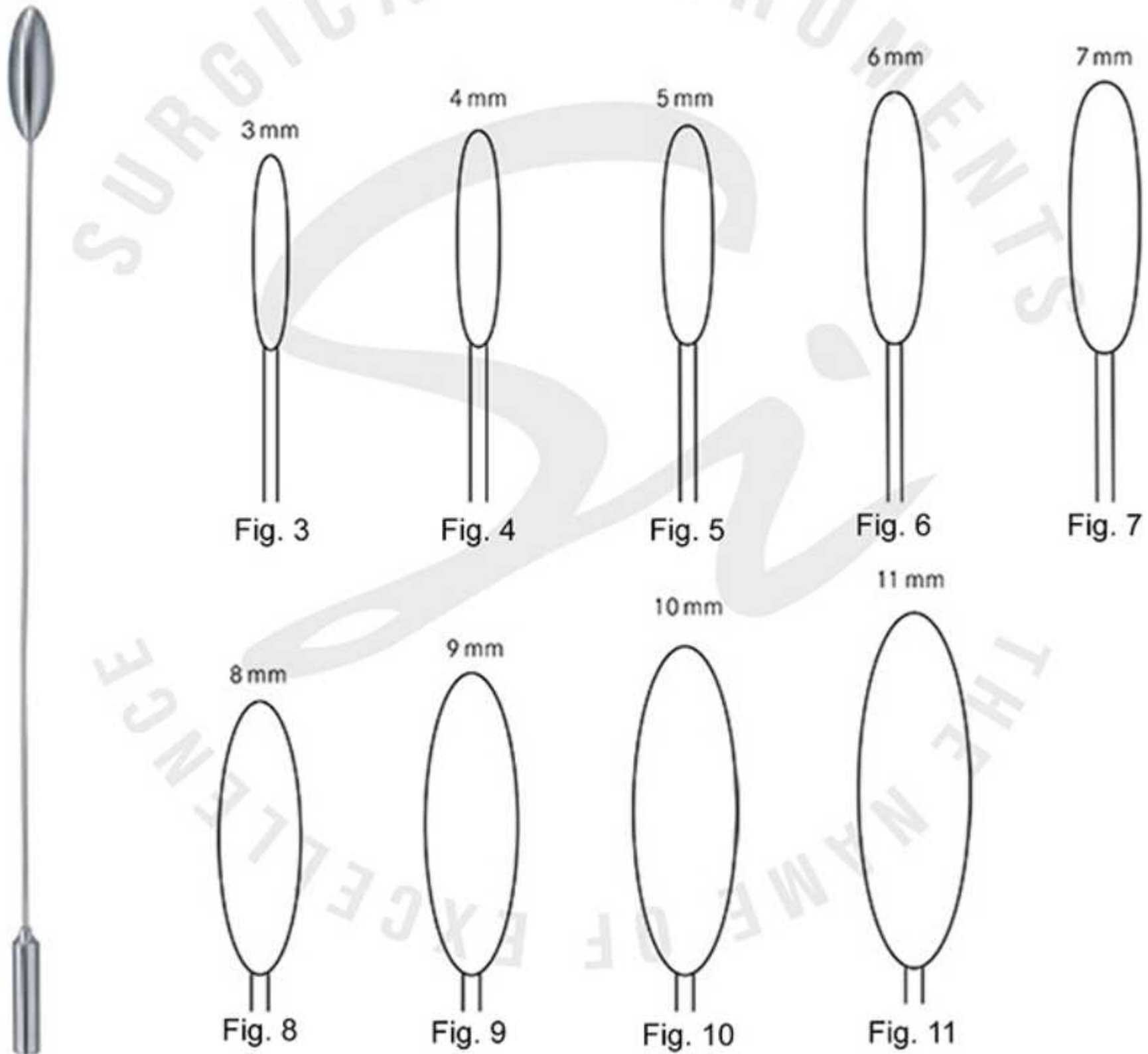

Bakes Gall Duck Dilators 300 mm – 12 "

SI-786-3-308

Malleable: Set of 9 Pcs Fig. 3 To Fig. 11

Instruments pour calculs biliaires
Gall stone instruments
Instrumental para coger cálculos biliares
Strumenti per canali bilari

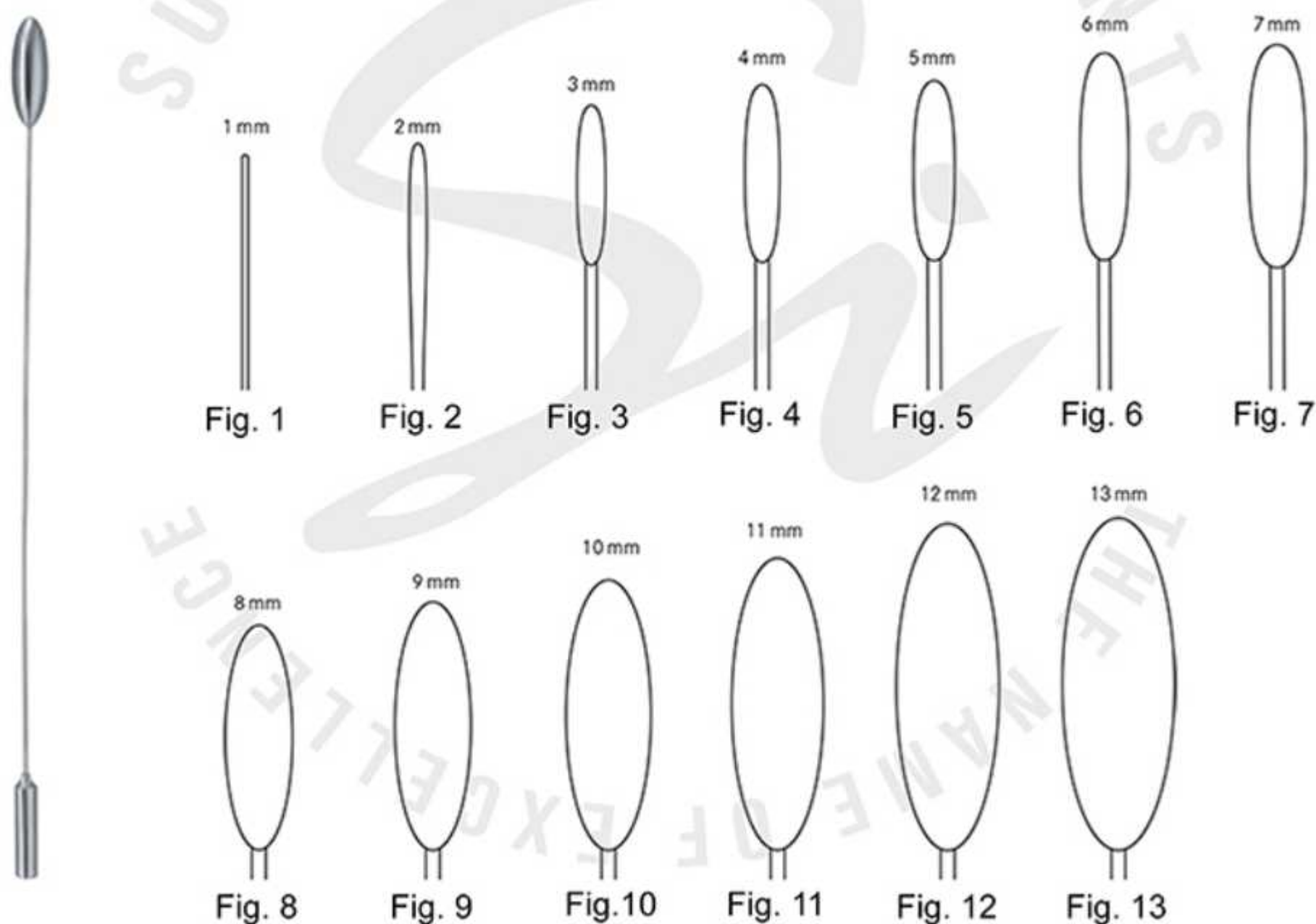

Bakes Gall Duck Dilators 300 mm – 12 "

SI-786-3-309

Malleable: Set of 13 Pcs Fig. 1 To Fig. 13

Instruments pour calculs biliaires
Gall stone instruments
Instrumental para coger cálculos biliares
Strumenti per canali bilari



Fig. 1
4 mm Ø
SI-786-3-310



Fig. 2
6mm Ø
SI-786-3-311



Fig. 3
8 mm Ø
SI-786-3-312

Desjardins Gall Duct Dilator 280 mm – 11 "
Elastic



Fig. 1
4 mm Ø Fig. 2
6mm Ø Fig. 3
8 mm Ø

Desjardins Gall Duct Dilator 280 mm – 11 "
SI-786-3-313
Elastic: Set of 3 Pcs Fig. 1 To Fig. 3



Fig. 1
6mm Ø

Desjardins Gall Duct Dilator
230 mm – 12 "
Elastic: **SI-786-3-314**

Instruments pour calculs biliaires
Gall stone instruments
Instrumental para coger cálculos biliares
Strumenti per canali bilari



Fig. 2
8mm Ø
SI-786-3-314



Fig. 3
10mm Ø
SI-786-3-315



Fig. 4
12mm Ø
SI-786-3-316

Desjardins Gall Duct Dilator 230 mm – 12 "
Elastic



Moynihan Gall Stone Probe 340 mm – 13 1/2 "
Malleable: x = 5 mm: **SI-786-3-318**



Pinces pour les calculs rénaux
Kidney stone forceps
Pinzas para cálculos renales
Pinze per calcoli renali



Randall Kidney Stone Forceps
230 mm – 9 "
SI-786-3-288



Randall Kidney Stone Forceps
220 mm – 8 3/4 "
SI-786-3-289



Randall Kidney Stone Forceps
190 mm – 7 1/2 "
SI-786-3-290

Pinces pour les calculs rénaux
Kidney stone forceps
Pinzas para cálculos renales
Pinze per calcoli renali



Fig. 4

Randall Kidney Stone Forceps
190 mm – 7 1/2 "
SI-786-3-291

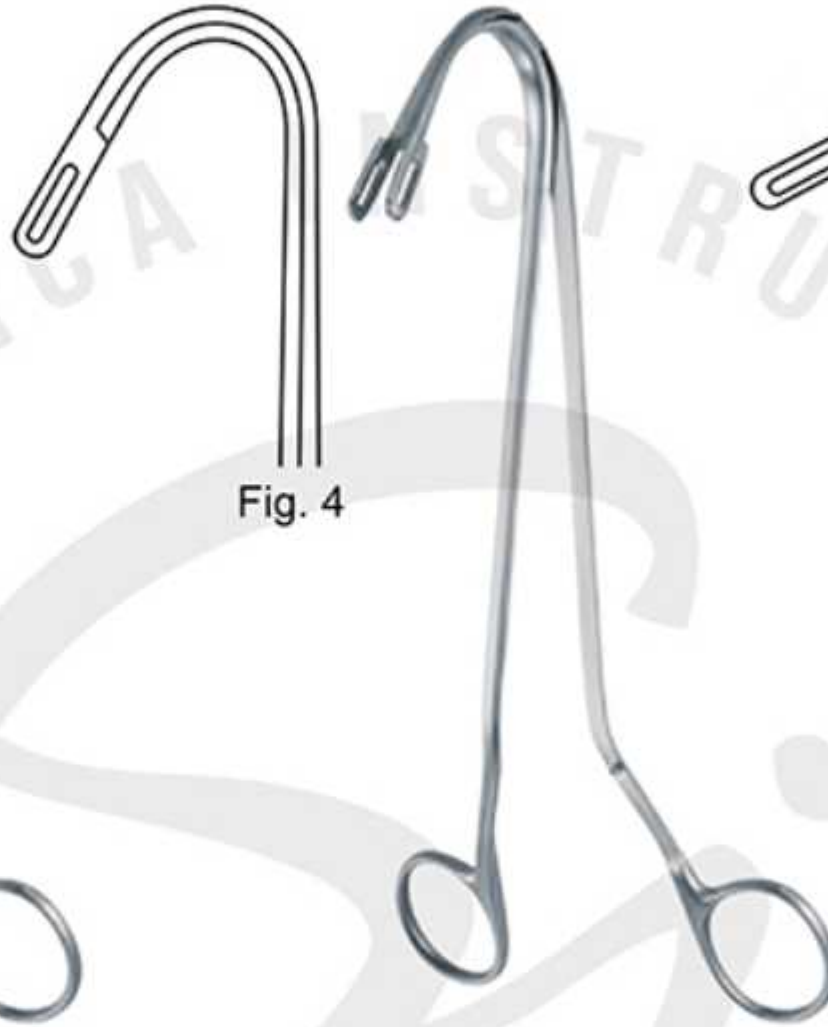

Fig. 5

Randall Kidney Stone Forceps
190 mm – 7 1/2 "
SI-786-3-292



Fig. 6

Randall Kidney Stone Forceps
190 mm – 7 1/2 "
SI-786-3-293

Curettes pour calculs biliaires
Gall stone scoops
Cucharillas para coger cálculos biliares
Cucchiai per colcoli bilari



Fig. 000
SI-786-3-317



Fig. 00
SI-786-3-318



Fig. 0
SI-786-3-319

Luer-Koerte Gall Stone Scoops 320 mm – 12 1/2 "
Malleable, Blunt:



Fig. 1
SI-786-3-320



Fig. 2
SI-786-3-323



Fig. 3
SI-786-3-324

Curettes pour calculs biliaires
Gall stone scoops
Cucharillas para coger cálculos biliares
Cucchiai per colcoli bilari

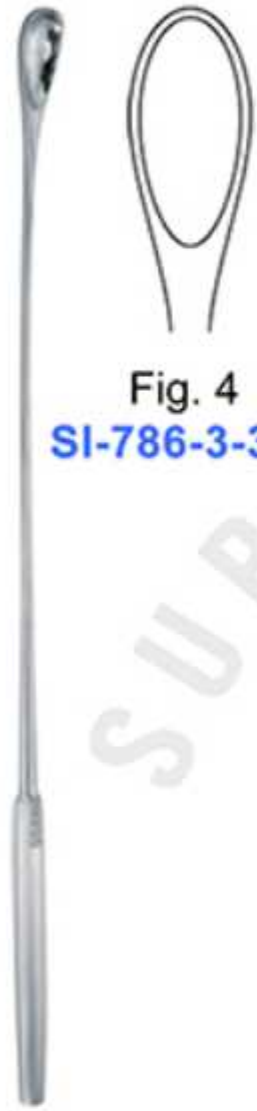

Fig. 4
SI-786-3-325



Fig. 5
SI-786-3-326

Luer-Koerte Gall Stone Scoops 320 mm – 12 1/2 "
Malleable, Blunt:



Fig. 000



Fig. 00



Fig. 0



Fig. 1



Fig. 2



Fig. 3



Fig. 4



Fig. 5

Luer-Koerte Gall Stone Scoops 320 mm – 12 1/2 "
Malleable, Blunt: Set Of 8 Pcs Fig. 000 To Fig. 5
SI-786-3-327

Curettes pour calculs biliaires
Gall stone scoops
Cucharillas para coger cálculos biliares
Cucchiai per colcoli bilari



Fergusson Gall Stone Scoops
215 mm – 8 1/2 "
SI-786-3-328



Fergusson Gall Stone Scoops
220 mm – 8 3/4 "
SI-786-3-329



Fergusson Gall Stone Scoops
235 mm – 9 1/4 "
SI-786-3-330

Curettes pour calculs biliaires
Gall stone scoops
Cucharillas para coger cálculos biliares
Cucchiai per colcoli bilari



Fergusson Gall Stone Scoops Set of 3 Pcs
SI-786-3-331

Mayo Gall Stone Scoops
280 mm – 11 "
SI-786-3-332

Instruments pour calculs biliaires
Gall stone instruments
Instrumental para coger cálculos biliares
Strumenti per canali bilari



Blake Gull Stone Forceps 200 mm – 8 "

Desjardins Gull Stone Forceps
230 mm – 9 "
SI-786-3-335



Instruments pour calculs biliaires
Gall stone instruments
Instrumental para coger cálculos biliares
Strumenti per canali bilari



Czerny Gull Stone Forceps
245 mm – 9 3/4 "
SI-786-3-336



Turner Warwick Gull Stone Forceps
180 mm – 7 "
SI-786-3-337



Turner Warwick Gull Stone Forceps
190 mm – 7 1/2 "
SI-786-3-338

Ecarteurs prostatiques
Separadores para la próstata
Divaricatori prostatici



Young Prostatic Retractor
210 mm – 8 1/4 "
SI-786-3-339



Young Prostatic Retractor
220 mm – 8 3/4 "
SI-786-3-340



Young Prostatic Retractor
210 mm – 8 1/4 "
SI-786-3-341



Young Prostatic Retractor
210 mm – 8 1/4 "
SI-786-3-342

Instruments pour prostatectomie
Prostatectomy Forceps
Instrumentos para prostatectomía
Strumenti per operazioni della prostata



Millin Prostatectomy Forceps
230 mm – 9 "
SI-786-3-343

Millin Prostatic Lobe Holding Forceps
230 mm – 9 "
SI-786-3-344



Millin Ligatur Carrying Forceps
240 mm – 9 1/2 "
SI-786-3-345



Young Prostate Holding Forceps
205 mm – 8 "
SI-786-3-346

Ecarteurs vésicaux
Bladder Retractors
Separadores vesicales
Divaricatori vescicali

160 MM Opening



Thomson-Walker Bladder Retractor
Complete With 2 Pairs of Lateral Blades
1 Central Blade:
SI-786-3-347

120 MM Opening



Millin Bladder Retractor
Complete:
2 Blades Size:
57 mm x 25 mm
2 Blades Size:
80 mm x 25 mm
1 Center Blade:
120 mm x 45 mm
SI-786-3-348

70 MM Opening



Legueu Bladder Retractor
SI-786-3-349

Ecarteurs vésicaux
Bladder Retractors
Separadores vesicales
Divaricatori vescicali

90 MM Opening



Judd-Masson Bladder Retractor
SI-786-3-350



Legueu Bladder Retractor
270 mm – 10 3/4 "
x = 35 mm
SI-786-3-351



Kocher Bladder Retractor
260 mm – 10 1/4 "
x = 67 mm
SI-786-3-352



Millin Bladder Retractor
285 mm – 11 1/4 "
SI-786-3-353

Bougies dilatatrices
Dilating Bougies
Bujías dilatadoras
Candelette dilatatrici



Dittel Dilating Bougies
190 mm – 7 1/2"
Straight

2 2/3 mm Ø	8 Charr./Fr.	SI-786-3-354
3 mm Ø	9 Charr./Fr.	SI-786-3-354A
3 1/3 mm Ø	10 Charr./Fr.	SI-786-3-354B
3 2/3 mm Ø	11 Charr./Fr.	SI-786-3-354C
4 mm Ø	12 Charr./Fr.	SI-786-3-354D
4 1/3 mm Ø	13 Charr./Fr.	SI-786-3-354E
4 2/3 mm Ø	14 Charr./Fr.	SI-786-3-354F
5 mm Ø	15 Charr./Fr.	SI-786-3-354G
5 1/3 mm Ø	16 Charr./Fr.	SI-786-3-354H
5 2/3 mm Ø	17 Charr./Fr.	SI-786-3-354I
6 mm Ø	18 Charr./Fr.	SI-786-3-354J
6 1/3 mm Ø	19 Charr./Fr.	SI-786-3-354K
6 2/3 mm Ø	20 Charr./Fr.	SI-786-3-354L
7 mm Ø	21 Charr./Fr.	SI-786-3-354M
7 1/3 mm Ø	22 Charr./Fr.	SI-786-3-354N
7 2/3 mm Ø	23 Charr./Fr.	SI-786-3-354O
8 mm Ø	24 Charr./Fr.	SI-786-3-354P
8 1/3 mm Ø	25 Charr./Fr.	SI-786-3-354Q
8 2/3 mm Ø	26 Charr./Fr.	SI-786-3-354R
9 mm Ø	27 Charr./Fr.	SI-786-3-354S
9 1/3 mm Ø	28 Charr./Fr.	SI-786-3-354T
9 2/3 mm Ø	29 Charr./Fr.	SI-786-3-354U
10 mm Ø	30 Charr./Fr.	SI-786-3-354V
10 2/3 mm Ø	32 Charr./Fr.	SI-786-3-354W
11 mm Ø	33 Charr./Fr.	SI-786-3-354X
11 1/3 mm Ø	34 Charr./Fr.	SI-786-3-354Y
12 mm Ø	36 Charr./Fr.	SI-786-3-354Z

Bougies dilatatrices
Dilating Bougies
Bujías dilatadoras
Candelette dilatatrici



2 2/3 mm Ø	8 Charr./Fr.	SI-786-3-355
3 mm Ø	9 Charr./Fr.	SI-786-3-355A
3 1/3 mm Ø	10 Charr./Fr.	SI-786-3-355B
3 2/3 mm Ø	11 Charr./Fr.	SI-786-3-355C
4 mm Ø	12 Charr./Fr.	SI-786-3-355D
4 1/3 mm Ø	13 Charr./Fr.	SI-786-3-355E
4 2/3 mm Ø	14 Charr./Fr.	SI-786-3-355F
5 mm Ø	15 Charr./Fr.	SI-786-3-355G
5 1/3 mm Ø	16 Charr./Fr.	SI-786-3-355H
5 2/3 mm Ø	17 Charr./Fr.	SI-786-3-355I
6 mm Ø	18 Charr./Fr.	SI-786-3-355J
6 1/3 mm Ø	19 Charr./Fr.	SI-786-3-355K
6 2/3 mm Ø	20 Charr./Fr.	SI-786-3-355L
7 mm Ø	21 Charr./Fr.	SI-786-3-355M
7 1/3 mm Ø	22 Charr./Fr.	SI-786-3-355N
7 2/3 mm Ø	23 Charr./Fr.	SI-786-3-355O
8 mm Ø	24 Charr./Fr.	SI-786-3-355P
8 1/3 mm Ø	25 Charr./Fr.	SI-786-3-355Q
8 2/3 mm Ø	26 Charr./Fr.	SI-786-3-355R
9 mm Ø	27 Charr./Fr.	SI-786-3-355S
9 1/3 mm Ø	28 Charr./Fr.	SI-786-3-355T
9 2/3 mm Ø	29 Charr./Fr.	SI-786-3-355U
10 mm Ø	30 Charr./Fr.	SI-786-3-355V
10 2/3 mm Ø	32 Charr./Fr.	SI-786-3-355W
11 mm Ø	33 Charr./Fr.	SI-786-3-355X
11 1/3 mm Ø	34 Charr./Fr.	SI-786-3-355Y
12 mm Ø	36 Charr./Fr.	SI-786-3-355Z

Dittel Dilating Bougies
350mm-13 3/4 "
Curved

Bougies dilatatrices
Dilating Bougies
Bujías dilatadoras
Candelette dilatatrici



Van Buren Dilating Bougies
280 mm – 11 "
Set, Fig. 08 – Fig. 36
SI-786-3-356S



Van Buren Dilating Bougies
270 mm – 10 3/4 "
Set, Fig. 8 – Fig. 30
Without Inner Thread
SI-786-3-357SET

2 2/3 mm Ø	8 Charr./Fr.	SI-786-3-356
3 1/3 mm Ø	10 Charr./Fr.	SI-786-3-356A
4 mm Ø	12 Charr./Fr.	SI-786-3-356B
4 2/3 mm Ø	14 Charr./Fr.	SI-786-3-356C
5 1/3 mm Ø	16 Charr./Fr.	SI-786-3-356D
6 mm Ø	18 Charr./Fr.	SI-786-3-356E
6 2/3 mm Ø	20 Charr./Fr.	SI-786-3-356F
7 1/3 mm Ø	22 Charr./Fr.	SI-786-3-356G
8 mm Ø	24 Charr./Fr.	SI-786-3-356H
8 2/3 mm Ø	26 Charr./Fr.	SI-786-3-356I
9 1/3 mm Ø	28 Charr./Fr.	SI-786-3-356J
10 mm Ø	30 Charr./Fr.	SI-786-3-356K
10 2/3 mm Ø	32 Charr./Fr.	SI-786-3-356L
11 1/3 mm Ø	34 Charr./Fr.	SI-786-3-356M
12 mm Ø	36 Charr./Fr.	SI-786-3-356N

2 2/3 mm Ø	8 Charr./Fr.	SI-786-3-357
3 mm Ø	9 Charr./Fr.	SI-786-3-357A
3 1/3 mm Ø	10 Charr./Fr.	SI-786-3-357B
3 2/3 mm Ø	11 Charr./Fr.	SI-786-3-357C
4 mm Ø	12 Charr./Fr.	SI-786-3-357D
4 1/3 mm Ø	13 Charr./Fr.	SI-786-3-357E
4 2/3 mm Ø	14 Charr./Fr.	SI-786-3-357F
5 mm Ø	15 Charr./Fr.	SI-786-3-357G
5 1/3 mm Ø	16 Charr./Fr.	SI-786-3-357H
5 2/3 mm Ø	17 Charr./Fr.	SI-786-3-357I
6 mm Ø	18 Charr./Fr.	SI-786-3-357J
6 1/3 mm Ø	19 Charr./Fr.	SI-786-3-357K
6 2/3 mm Ø	20 Charr./Fr.	SI-786-3-357L
7 mm Ø	21 Charr./Fr.	SI-786-3-357M
7 1/3 mm Ø	22 Charr./Fr.	SI-786-3-357N
7 2/3 mm Ø	23 Charr./Fr.	SI-786-3-357O
8 mm Ø	24 Charr./Fr.	SI-786-3-357P
8 1/3 mm Ø	25 Charr./Fr.	SI-786-3-357Q
8 2/3 mm Ø	26 Charr./Fr.	SI-786-3-357R
9 mm Ø	27 Charr./Fr.	SI-786-3-357S
9 1/3 mm Ø	28 Charr./Fr.	SI-786-3-357T
9 2/3 mm Ø	29 Charr./Fr.	SI-786-3-357U
10 mm Ø	30 Charr./Fr.	SI-786-3-357V

Metallkatheter für Frauen
Metal catheters for women
Sondes métalliques pour femmes
Sondas metálicas para mujeres
Sonde metalliche per donne



- SI-786-3-358
- SI-786-3-358A
- SI-786-3-358B
- SI-786-3-358C
- SI-786-3-358D
- SI-786-3-358E
- SI-786-3-358F
- SI-786-3-358G
- SI-786-3-358H
- SI-786-3-358I
- SI-786-3-358J
- SI-786-3-358K
- SI-786-3-358L
- SI-786-3-358M
- SI-786-3-358N
- SI-786-3-358O
- SI-786-3-358P
- SI-786-3-358Q
- SI-786-3-358R

Guyon Metal catheters for women
160 mm – 6 1/4 "

- 2 mm Ø
- 2 1/3 mm Ø
- 2 2/3 mm Ø
- 3 mm Ø
- 3 1/3 mm Ø
- 3 2/3 mm Ø
- 4 mm Ø
- 4 1/3 mm Ø
- 4 2/3 mm Ø
- 5 mm Ø
- 5 1/3 mm Ø
- 5 2/3 mm Ø
- 6 mm Ø
- 6 1/3 mm Ø
- 6 2/3 mm Ø
- 7 mm Ø
- 7 1/3 mm Ø
- 7 2/3 mm Ø
- 8 mm Ø



- SI-786-5-359
- SI-786-5-359A
- SI-786-5-359B
- SI-786-5-359C
- SI-786-5-359D
- SI-786-5-359E
- SI-786-5-359F
- SI-786-5-359G
- SI-786-5-359H
- SI-786-5-359I
- SI-786-5-359J
- SI-786-5-359K
- SI-786-5-359L
- SI-786-5-359M
- SI-786-5-359N
- SI-786-5-359O
- SI-786-5-359P
- SI-786-5-359Q
- SI-786-5-359R

Guyon Metal catheters for Male
280 mm – 11 "

- 6 Charr./Fr.
- 7 Charr./Fr.
- 8 Charr./Fr.
- 9 Charr./Fr.
- 10 Charr./Fr.
- 11 Charr./Fr.
- 12 Charr./Fr.
- 13 Charr./Fr.
- 14 Charr./Fr.
- 15 Charr./Fr.
- 16 Charr./Fr.
- 17 Charr./Fr.
- 18 Charr./Fr.
- 19 Charr./Fr.
- 20 Charr./Fr.
- 21 Charr./Fr.
- 22 Charr./Fr.
- 23 Charr./Fr.
- 24 Charr./Fr.

Bougies dilatatrices
Dilating Bougies
Bujías dilatadoras
Candelette dilatatrici



Clutton Urethral Bougies
280 mm – 11 "
SI-SET-786-4-160
6 - 10 FG To 28 - 32 FG
Set Of 12 Pcs



Clutton Urethral Bougies
280 mm – 11 "

6 - 10 FG	SI-CB-786-4-160
8 - 12 FG	SI-CB-786-4-160A
10 - 14 FG	SI-CB-786-4-160B
12 - 16 FG	SI-CB-786-4-160C
14 - 18 FG	SI-CB-786-4-160D
16 - 20 FG	SI-CB-786-4-160E
18 - 22 FG	SI-CB-786-4-160F
20 - 24 FG	SI-CB-786-4-160G
22 - 26 FG	SI-CB-786-4-160H
24 - 28 FG	SI-CB-786-4-160I
26 - 30 FG	SI-CB-786-4-160J
28 - 32 FG	SI-CB-786-4-160K

Bougies dilatatrices
Dilating Bougies
Bujías dilatadoras
Candelette dilatatrici



McCREA Dilating Bougies
195mm – 8³/₄"

2 2/3 mm Ø	8 Charr./Fr.	SI-786-30-358
3 1/3 mm Ø	10 Charr./Fr.	SI-786-30-358A
4 mm Ø	12 Charr./Fr.	SI-786-30-358B
4 2/3 mm Ø	14 Charr./Fr.	SI-786-30-358C
5 1/3 mm Ø	16 Charr./Fr.	SI-786-30-358D
6 mm Ø	18 Charr./Fr.	SI-786-30-358E
6 2/3 mm Ø	20 Charr./Fr.	SI-786-30-358F
7 1/3 mm Ø	22 Charr./Fr.	SI-786-30-358G
8 mm Ø	24 Charr./Fr.	SI-786-30-358H
8 2/3 mm Ø	26 Charr./Fr.	SI-786-30-358I
9 1/3 mm Ø	28 Charr./Fr.	SI-786-30-358J
10 mm Ø	30 Charr./Fr.	SI-786-30-358K
10 2/3 mm Ø	32 Charr./Fr.	SI-786-30-358L
11 1/3 mm Ø	34 Charr./Fr.	SI-786-30-358M
12 mm Ø	36 Charr./Fr.	SI-786-30-358N



WALTHER Dilating Bougies
240 mm – 9 1/2 "
[SI-786-30-359](#)

2 2/3 mm Ø	8 Charr./Fr.	SI-786-30-359
3 1/3 mm Ø	10 Charr./Fr.	SI-786-30-359A
4 mm Ø	12 Charr./Fr.	SI-786-30-359B
4 2/3 mm Ø	14 Charr./Fr.	SI-786-30-359C
5 1/3 mm Ø	16 Charr./Fr.	SI-786-30-359D
6 mm Ø	18 Charr./Fr.	SI-786-30-359E
6 2/3 mm Ø	20 Charr./Fr.	SI-786-30-359F
7 1/3 mm Ø	22 Charr./Fr.	SI-786-30-359G
8 mm Ø	24 Charr./Fr.	SI-786-30-359H
8 2/3 mm Ø	26 Charr./Fr.	SI-786-30-359I
9 1/3 mm Ø	28 Charr./Fr.	SI-786-30-359J
10 mm Ø	30 Charr./Fr.	SI-786-30-359K
10 2/3 mm Ø	32 Charr./Fr.	SI-786-30-359L
11 1/3 mm Ø	34 Charr./Fr.	SI-786-30-359M
12 mm Ø	36 Charr./Fr.	SI-786-30-359N

Bougies dilatatrices
Dilating Bougies
Bujías dilatadoras
Candelette dilatatrici

Utrine Dilator
220 mm – 8 3/4 "

1 mm Ø	SI-786-8-35
2 mm Ø	SI-786-8-35A
3 mm Ø	SI-786-8-35B
4 mm Ø	SI-786-8-35C
5 mm Ø	SI-786-8-35D
6 mm Ø	SI-786-8-35E
7 mm Ø	SI-786-8-35F
8 mm Ø	SI-786-8-35G
9 mm Ø	SI-786-8-35H
10 mm Ø	SI-786-8-35I
11 mm Ø	SI-786-8-35J
12 mm Ø	SI-786-8-35K
13 mm Ø	SI-786-8-35L
14 mm Ø	SI-786-8-35M
15 mm Ø	SI-786-8-35N
16 mm Ø	SI-786-8-35O
17 mm Ø	SI-786-8-35P
18 mm Ø	SI-786-8-35Q
19 mm Ø	SI-786-8-35R
20 mm Ø	SI-786-8-35S
21 mm Ø	SI-786-8-35T
22 mm Ø	SI-786-8-35U
23 mm Ø	SI-786-8-35V
24 mm Ø	SI-786-8-35W
25 mm Ø	SI-786-8-35X
26 mm Ø	SI-786-8-35Y



Van Buren Dilating Bougies
180 mm – 7 "
Set, Fig. 08 – Fig. 30
SI-786-3-3520

2 2/3 mm Ø	8 Charr./Fr.	SI-786-3-3520
3 1/3 mm Ø	10 Charr./Fr.	SI-786-3-3521A
4 mm Ø	12 Charr./Fr.	SI-786-3-3522B
4 2/3 mm Ø	14 Charr./Fr.	SI-786-3-3523C
5 1/3 mm Ø	16 Charr./Fr.	SI-786-3-3524D
6 mm Ø	18 Charr./Fr.	SI-786-3-3525E
6 2/3 mm Ø	20 Charr./Fr.	SI-786-3-3526F
7 1/3 mm Ø	22 Charr./Fr.	SI-786-3-3527G
8 mm Ø	24 Charr./Fr.	SI-786-3-3528H
8 2/3 mm Ø	26 Charr./Fr.	SI-786-3-3529I
9 1/3 mm Ø	28 Charr./Fr.	SI-786-3-3530J
10 mm Ø	30 Charr./Fr.	SI-786-3-3531K



Bougies dilatatrices
Dilating Bougies
Bujías dilatadoras
Candelette dilatatrici



Hawkin Ambler Dialtor
180 mm – 7 "
3/6 mm To 18/21 mm
SI-786-SET-30-360

3/6 mm	SI-786-30-360
4/7 mm	SI-786-30-360A
5/8 mm	SI-786-30-360B
6/9 mm	SI-786-30-360C
7/10 mm	SI-786-30-360D
8/11 mm	SI-786-30-360E
9/12 mm	SI-786-30-360F
10/13 mm	SI-786-30-360G
11/14 mm	SI-786-30-360H
12/15 mm	SI-786-30-360I
13/16 mm	SI-786-30-360J
14/17 mm	SI-786-30-360K
15/18 mm	SI-786-30-360L
16/19 mm	SI-786-30-360M
17/20 mm	SI-786-30-360N
18/21 mm	SI-786-30-360O



Lister Urethral Bougies
280 mm – 11 "
00/1 To 15/18
Set of 18 Pcs
SI-786-SET-30-361

00 - 1 EG	SI-786-30-361
0 - 2 EG	SI-786-30-361A
0.5 - 3 EG	SI-786-30-361B
1 - 4 EG	SI-786-30-361C
2 - 5 EG	SI-786-30-361D
3 - 6 EG	SI-786-30-361E
4 - 7 EG	SI-786-30-361F
5 - 8 EG	SI-786-30-361G
6 - 9 EG	SI-786-30-361H
7 - 10 EG	SI-786-30-361I
8 - 11 EG	SI-786-30-361J
9 - 12 EG	SI-786-30-361K
10 - 13 EG	SI-786-30-361L
11 - 14 EG	SI-786-30-361M
12 - 15 EG	SI-786-30-361N
13 - 16 EG	SI-786-30-361O
14 - 17 EG	SI-786-30-361P
15 - 18 EG	SI-786-30-361Q

Bougies dilatatrices
Dilating Bougies
Bujías dilatadoras
Candelette dilatatrici



Filiform Guides
Olive Tip
330 mm - 14"
SI-786-30-30

Guyon
250 mm - 10"
SI-786-30-31
Urethral Bougies and
Dilating Sounds
Without Filiform Guides
With Thread in Tip

8 Charr./Fr.	SI-786-30-31
9 Charr./Fr.	SI-786-30-31A
10 Charr./Fr.	SI-786-30-31B
11 Charr./Fr.	SI-786-30-31C
12 Charr./Fr.	SI-786-30-31D
13 Charr./Fr.	SI-786-30-31E
14 Charr./Fr.	SI-786-30-31F
15 Charr./Fr.	SI-786-30-31G
16 Charr./Fr.	SI-786-30-31H
17 Charr./Fr.	SI-786-30-31I
18 Charr./Fr.	SI-786-30-31J
19 Charr./Fr.	SI-786-30-31K
20 Charr./Fr.	SI-786-30-31L
21 Charr./Fr.	SI-786-30-31M
22 Charr./Fr.	SI-786-30-31N
23 Charr./Fr.	SI-786-30-31O
24 Charr./Fr.	SI-786-30-31P
25 Charr./Fr.	SI-786-30-31Q
26 Charr./Fr.	SI-786-30-31R
27 Charr./Fr.	SI-786-30-31S
28 Charr./Fr.	SI-786-30-31T
29 Charr./Fr.	SI-786-30-31U
30 Charr./Fr.	SI-786-30-31V

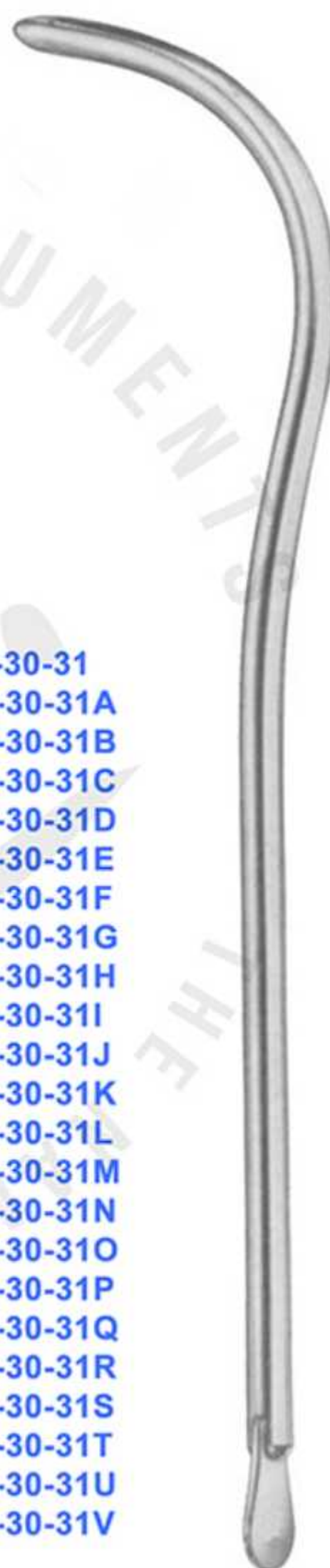

Instruments de circoncision
Circumcision instruments
Instrumentos para circuncisión
Strumenti per circoncisione



Gomco Circumcision Clamp

8 mm	SI-786-3-360
11 mm	SI-786-3-360A
13 mm	SI-786-3-360B
16 mm	SI-786-3-360C
21 mm	SI-786-3-360D
26 mm	SI-786-3-360E
32 mm	SI-786-3-360F



Winkelmann Circumcision Clamps

8 mm	SI-786-3-361
10 mm	SI-786-3-361A
12 mm	SI-786-3-361B
14 mm	SI-786-3-361C
16 mm	SI-786-3-361D
18 mm	SI-786-3-361E
20 mm	SI-786-3-361F



MOGEN CIRCUMCISION CLAMP

Small	SI-786-3-362
Medium	SI-786-3-362A
Large	SI-786-3-362B

Si **SURGICA**
INSTRUMENTS
THE NAME OF EXCELLENCE



MAGEN, DARM – STOMACH, INTESTINES

- TISSUE AND INTESTINAL HOLDING FORCEPS
- INTESTINAL AND STOMACH CLAMPS
- GATRAUMATIC INTESTINAL CLAMP FORCEPS
- RECTAL SPECULA
- ANUSCOPES, PROCTOSCOPES, RECTOSCOPES, SPHINCTEROSCOPES
- HAEMORRHOIDAL FORCEPS
- HAEMORRHOIDAL LIGATORS

Pinces intestinales et de tissue
Tissue and intestinal holding forceps
Pinzas para tejidos y intestinos
Pinze per tessuti ed intestinali



Allis-Baby
140 mm – 5 1/2 "
SI-786-6-01
Teeth 4x5



Allis
150 mm – 6" **SI-786-6-02**
190 mm – 7 1/2 " **SI-786-6-02A**
250 mm – 9 3/4 " **SI-786-6-02B**
Teeth 4x5 / 5x6



Allis-Adair
155 mm – 6 "
SI-786-6-03
Teeth 10x11



Thoms-Allis
200 mm – 8 "
SI-786-6-04
Teeth 6x7



Lockwood
200 mm – 8 "
SI-786-6-05

Pinces intestinales et de tissue
Tissue and intestinal holding forceps
Pinzas para tejidos y intestinos
Pinze per tessuti ed intestinali



Williams
160 mm – 6 1/4 "
SI-786-6-06



Littlewood
190 mm – 7 1/2 "
SI-786-6-07
Teeth 2x3



Boys-Allis
150 mm – 6 "
SI-786-6-08
Teeth 5x6



Judd-Allis
150 mm – 6 "
190 mm – 7 1/2 "
Teeth 3x4
SI-786-6-09
SI-786-6-09A

Pinces intestinales et de tissue
Tissue and intestinal holding forceps
Pinzas para tejidos y intestinos
Pinze per tessuti ed intestinali



Babcock
160 mm – 6 1/4" **SI-786-6-10**
180 mm – 7" **SI-786-6-10A**
200 mm – 8" **SI-786-6-10B**
240 mm – 9 1/2" **SI-786-6-10C**



Babcock
160 mm – 6 1/4" **SI-786-6-11**



Babcock
200 mm – 8" **SI-786-6-12**



Duval
180 mm – 7" **SI-786-6-13**
200 mm – 8" **SI-786-6-13A**
230 mm – 9" **SI-786-6-13B**

Pinces intestinales et de tissue
Tissue and intestinal holding forceps
Pinzas para tejidos y intestinos
Pinze per tessuti ed intestinali



Duval
180 mm – 7" **SI-786-6-14**
200 mm – 8" **SI-786-6-14A**
230 mm – 9" **SI-786-6-14B**



Duval
180 mm – 7" **SI-786-6-15**
200 mm – 8" **SI-786-6-15A**
230 mm – 9" **SI-786-6-15B**



Duval
200 mm – 8" **SI-786-6-16**



Babcock-Atrauma
160 mm – 6 1/4" **SI-786-6-17**

Pincas intestinales et de tissue
Tissue and intestinal holding forceps
Pinzas para tejidos y intestinos
Pinze per tessuti ed intestinali



Babcock-Atrauma
200 mm – 8"
SI-786-6-18



Duval-Atrauma
200 mm – 8"
SI-786-6-19



Duval-Atrauma
230 mm – 9"
SI-786-6-20

Pinces intestinales et de tissue
Tissue and intestinal holding forceps
Pinzas para tejidos y intestinos
Pinze per tessuti ed intestinali



Allis-Atrauma
160 mm – 6 1/4 "
SI-786-6-21



Allis-Atrauma
200 mm – 8 "
SI-786-6-22



Allis-Atrauma
250 mm – 9 3/4 "
SI-786-6-23

MAGEN, DARM – STOMACH, INTESTINES

Pinces-clamps pour l'intestin et l'estomac
Intestinal and stomach clamps
Pinzas-clamps para el intestino y el estomago
Pinze per intestino e stomaco

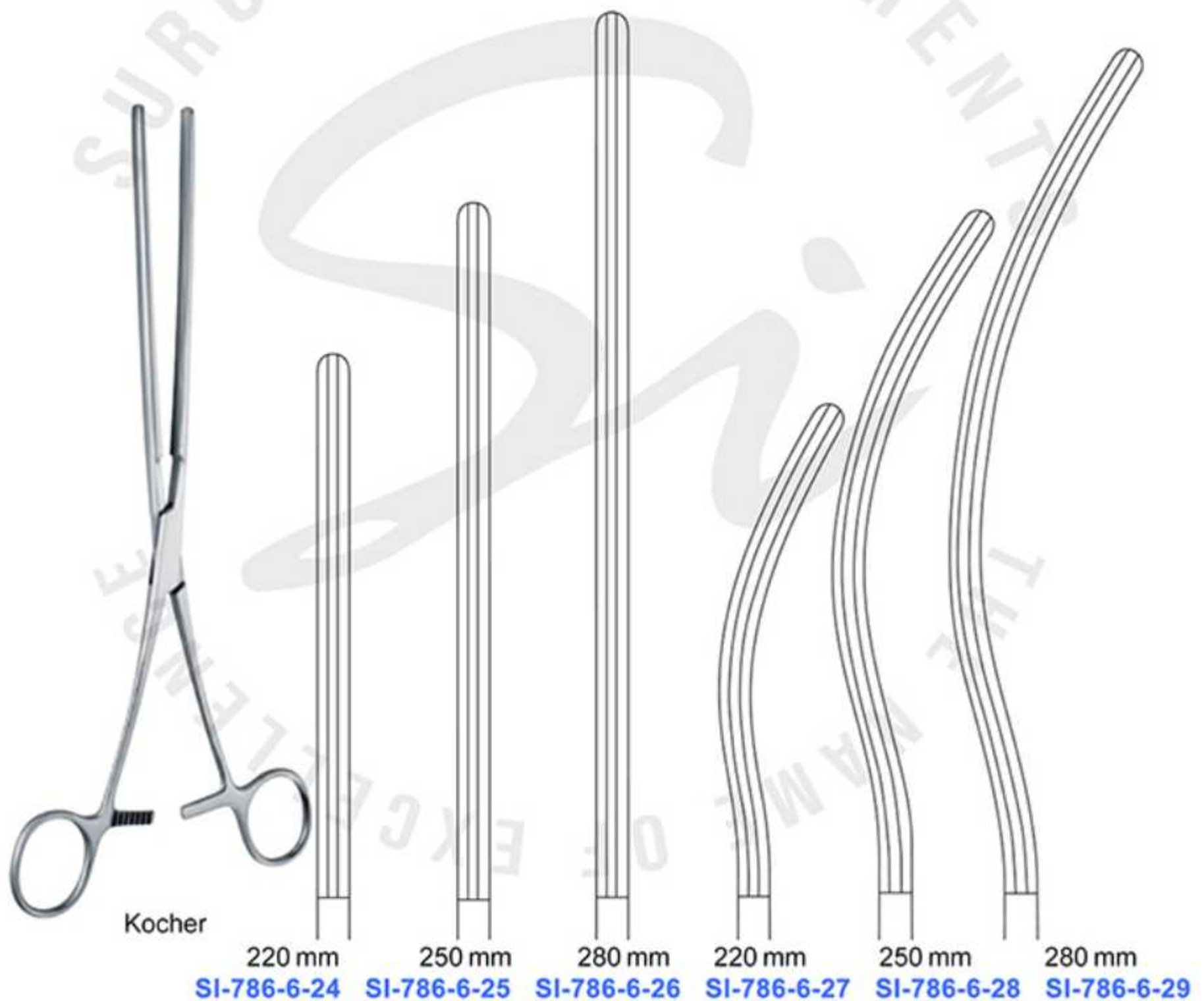

MAGEN, DARM – STOMACH, INTESTINES

Pinces-clamps pour l'intestin et l'estomac
Intestinal and stomach clamps
Pinzas-clamps para el intestino y el estomago
Pinze per intestino e stomaco



Allen
155 mm – 6 "
SI-786-6-30
1x2
Intestinal clamp for children



Baby-Kocher
130 mm – 5 "
SI-786-6-31
Intestinal clamp for children,
very elastic blades



Baby-Kocher
130 mm – 5 "
SI-786-6-32
Intestinal clamp for
children, very elastic blades



Baby-Doyen
180 mm – 7 "
SI-786-6-33
Straight



Baby-Doyen
180 mm – 7 "
SI-786-6-34
Curved

MAGEN, DARM – STOMACH, INTESTINES

Pinces-clamps pour l'intestin et l'estomac

Intestinal and stomach clamps

Pinzas-clamps para el intestino y el estomago

Pinze per intestino e stomaco



Doyen
210 mm – 8 1/4 " **SI-786-6-35**
230 mm – 9 " **SI-786-6-35A**
Straight



Doyen
210 mm – 8 1/4 " **SI-786-6-36**
230 mm – 9 " **SI-786-6-36A**
Curved

MAGEN, DARM – STOMACH, INTESTINES

Pinces-clamps pour l'intestin et l'estomac
Intestinal and stomach clamps
Pinzas-clamps para el intestino y el estomago
Pinze per intestino e stomaco

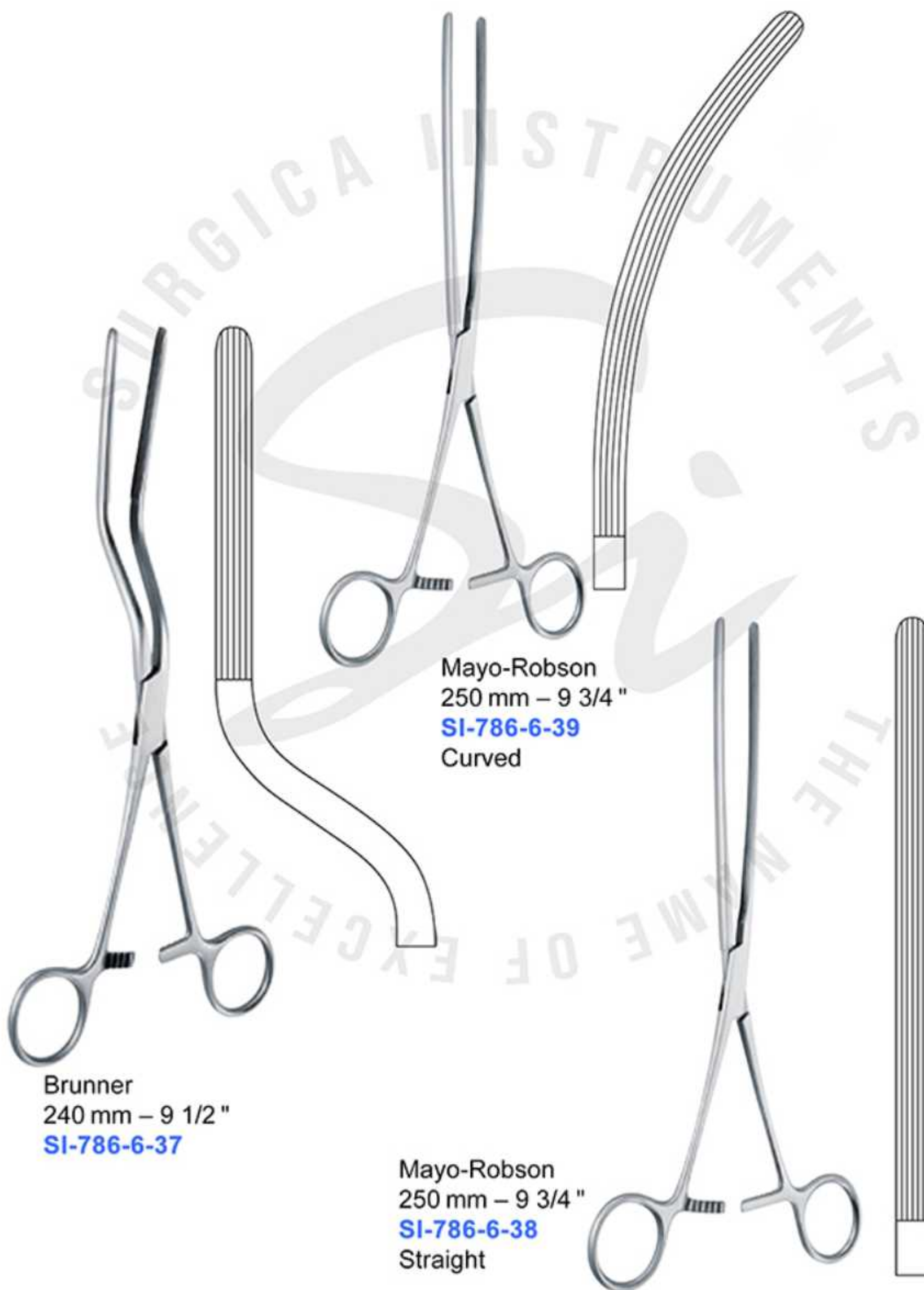

Brunner
240 mm – 9 1/2 "
SI-786-6-37

Mayo-Robson
250 mm – 9 3/4 "
SI-786-6-39
Curved

Mayo-Robson
250 mm – 9 3/4 "
SI-786-6-38
Straight

MAGEN, DARM – STOMACH, INTESTINES

Pinces-clamps pour l'intestin et l'estomac

Intestinal and stomach clamps

Pinzas-clamps para el intestino y el estomago

Pinze per intestino e stomaco



Lane
300 mm – 12"
SI-786-6-41
Curved



Lane
300 mm – 12"
SI-786-6-40
Straight

MAGEN, DARM – STOMACH, INTESTINES

Pinces-clamps pour l'intestin et l'estomac

Intestinal and stomach clamps

Pinzas-clamps para el intestino y el estomago

Pinze per intestino e stomaco



Doyen
140 mm – 5 1/2 "
SI-786-6-42
Straight



Doyen
160 mm – 6 1/4 "
SI-786-6-43
Straight



Doyen
180 mm – 7 "
SI-786-6-44
Straight



Doyen
210 mm – 8 1/4 "
SI-786-6-45
Straight

MAGEN, DARM – STOMACH, INTESTINES

Pinces-clamps pour l'intestin et l'estomac
Intestinal and stomach clamps
Pinzas-clamps para el intestino y el estomago
Pinze per intestino e stomaco



Doyen
230 mm – 9"
SI-786-6-46
Straight



Doyen
140 mm – 5 1/2"
SI-786-6-47
Curved



Doyen
160 mm – 6 1/4"
SI-786-6-48
Curved

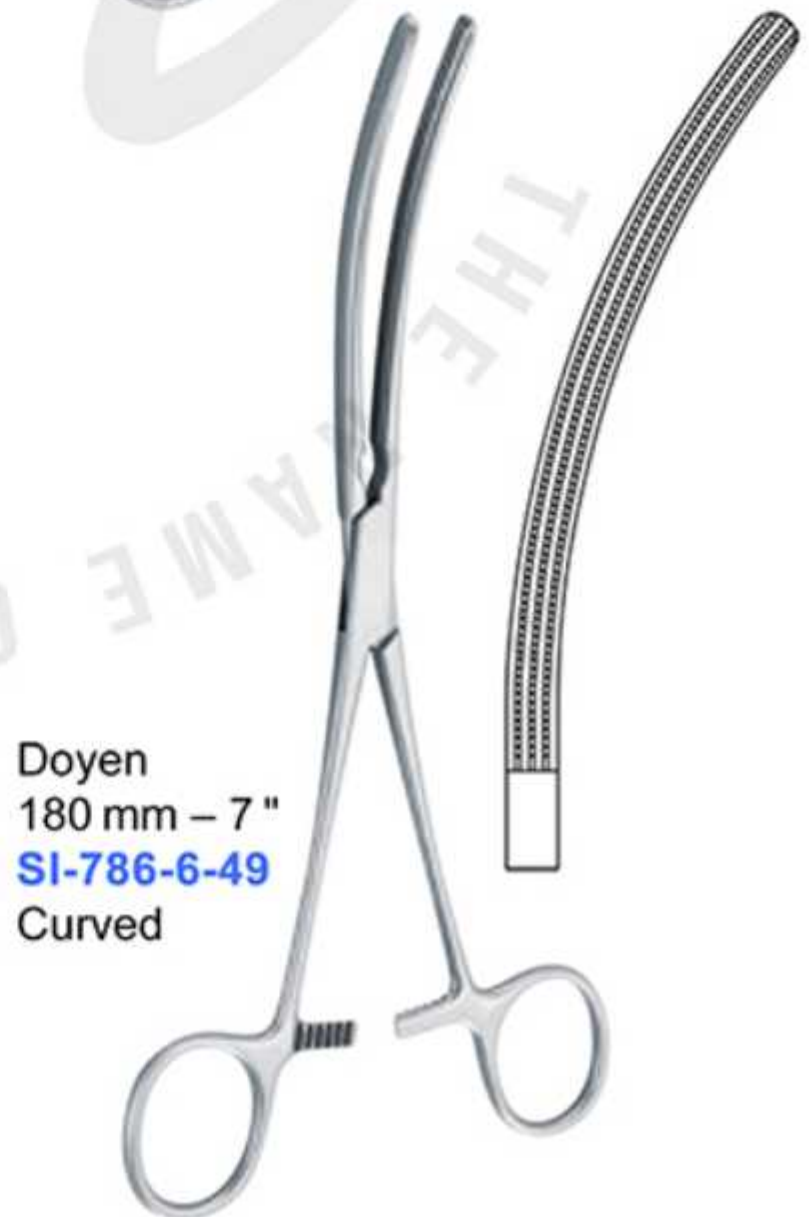

Doyen
180 mm – 7"
SI-786-6-49
Curved

MAGEN, DARM – STOMACH, INTESTINES

Pinces-clamps pour l'intestin et l'estomac
Intestinal and stomach clamps
Pinzas-clamps para el intestino y el estomago
Pinze per intestino e stomaco



Doyen
210 mm – 8 1/4 "
SI-786-6-50
Curved

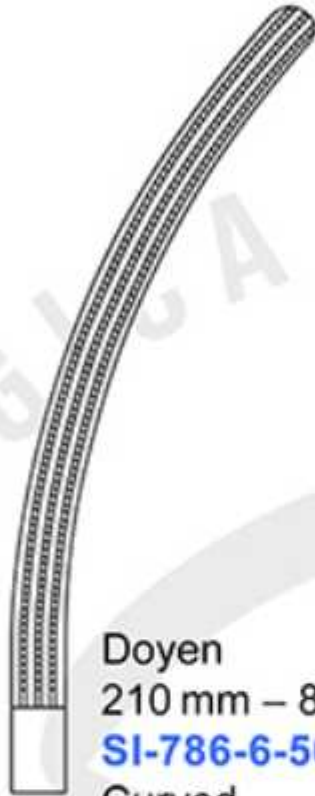

Doyen
230 mm – 9 "
SI-786-6-51
Curved



Mayo-Robson
250 mm – 9 3/4 "
SI-786-6-52
Straight



Mayo-Robson
250 mm – 9 3/4 "
SI-786-6-53
Curved



MAGEN, DARM – STOMACH, INTESTINES

Pinces-clamps pour l'intestin et l'estomac
Intestinal and stomach clamps
Pinzas-clamps para el intestino y el estomago
Pinze per intestino e stomaco

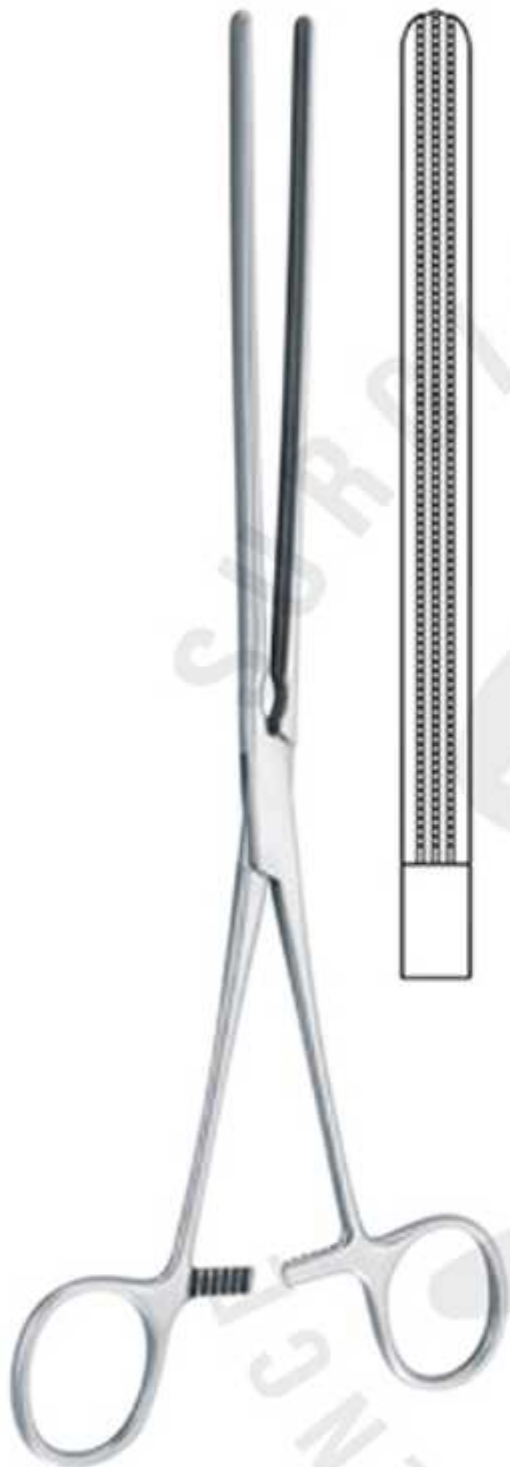

Kocher
220 mm – 8 3/4 "
SI-786-6-54

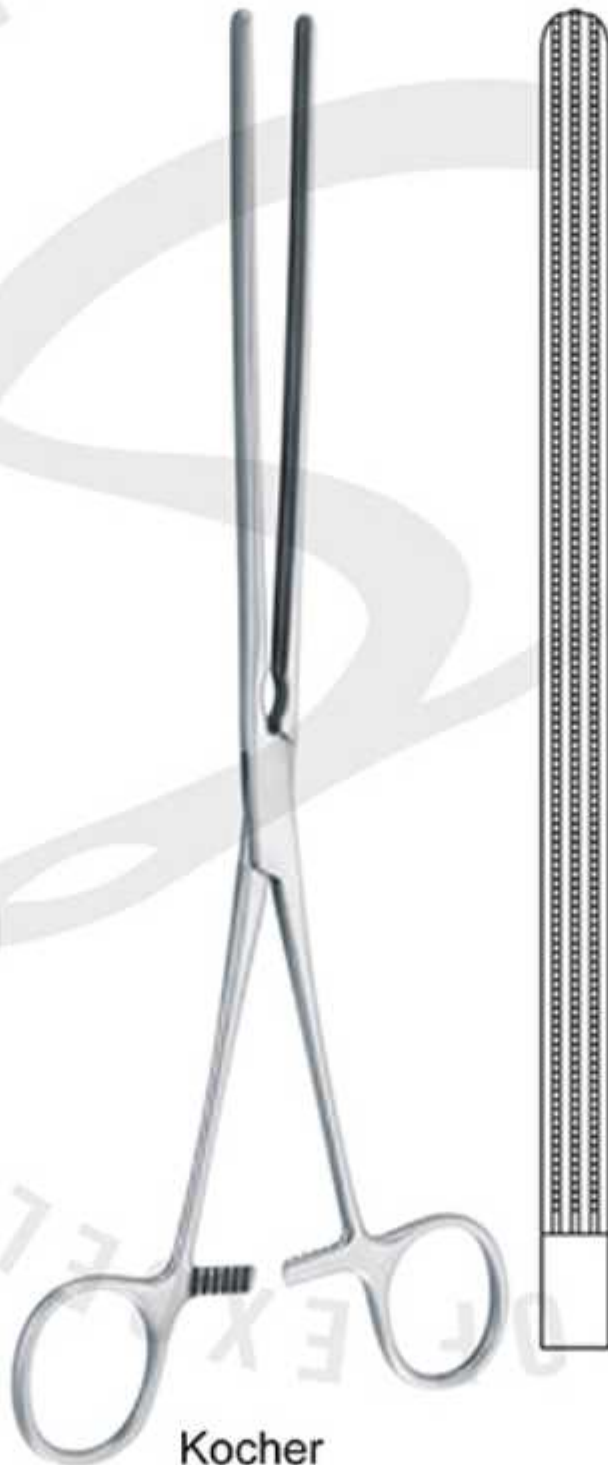

Kocher
250 mm – 9 3/4 "
SI-786-6-55



Kocher
280 mm – 11 "
SI-786-6-56

MAGEN, DARM – STOMACH, INTESTINES

Pinces-clamps pour l'intestin et l'estomac
Intestinal and stomach clamps
Pinzas-clamps para el intestino y el estomago
Pinze per intestino e stomaco

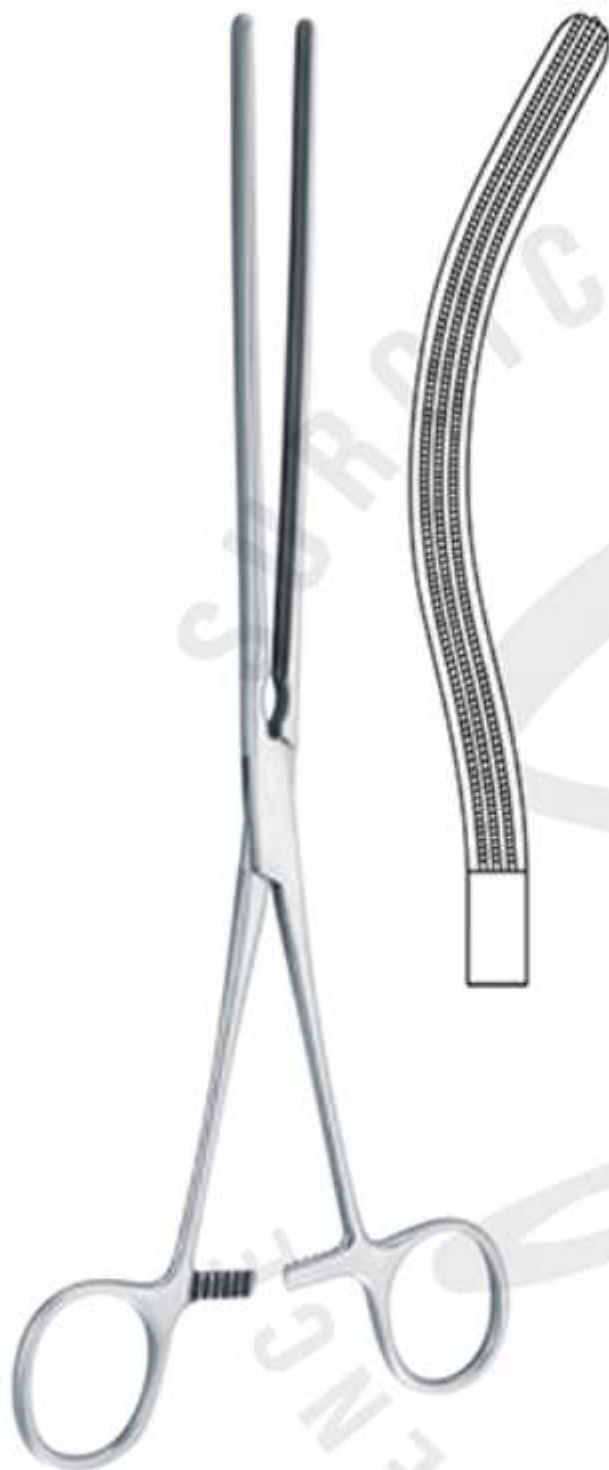

Kocher
220 mm – 8 3/4 "
SI-786-6-57



Kocher
250 mm – 9 3/4 "
SI-786-6-58

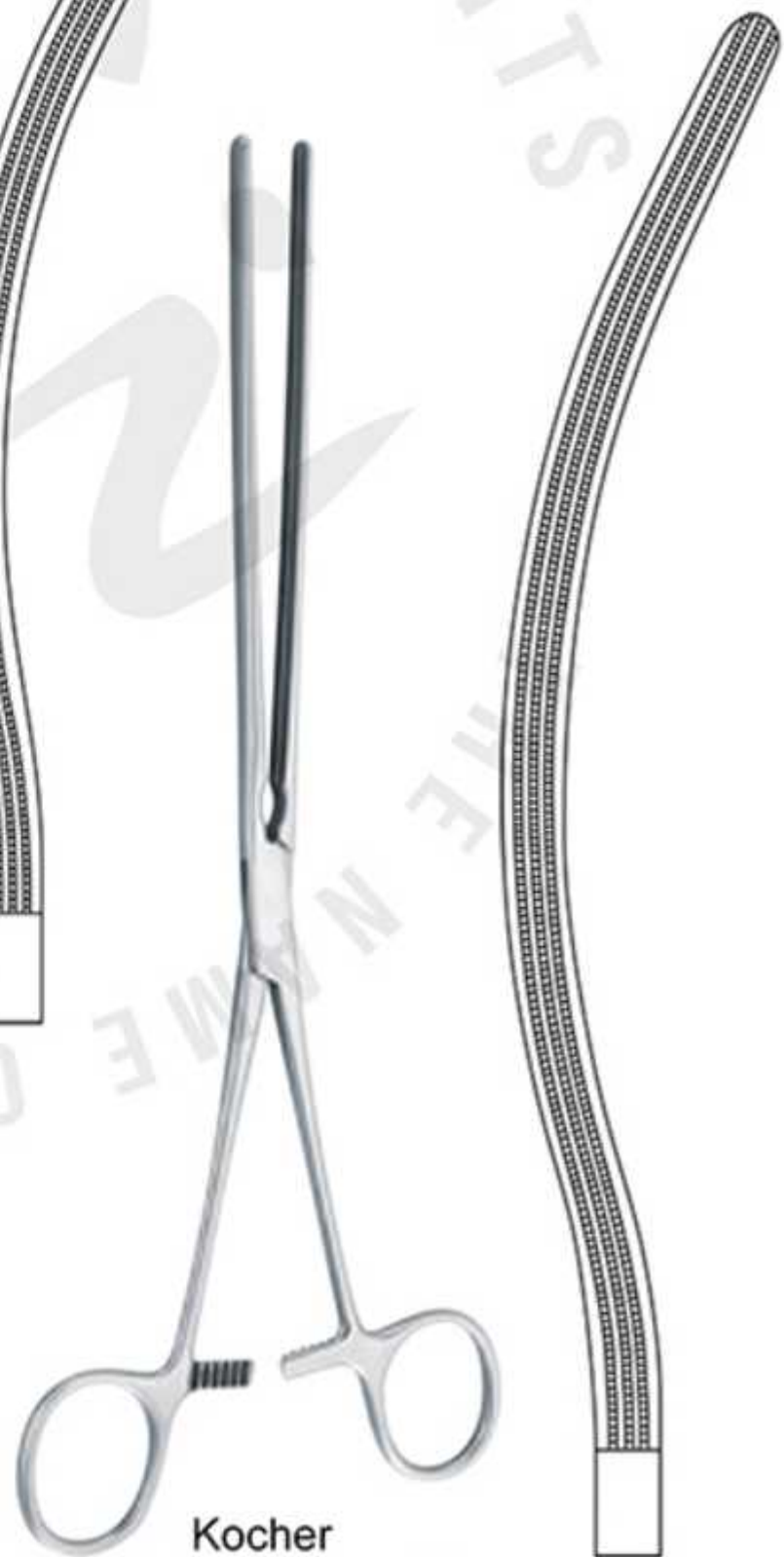

Kocher
280 mm – 11 "
SI-786-6-59

MAGEN, DARM – STOMACH, INTESTINES

Pinces-clamps pour l'intestin et l'estomac
Intestinal and stomach clamps
Pinzas-clamps para el intestino y el estomago
Pinze per intestino e stomaco

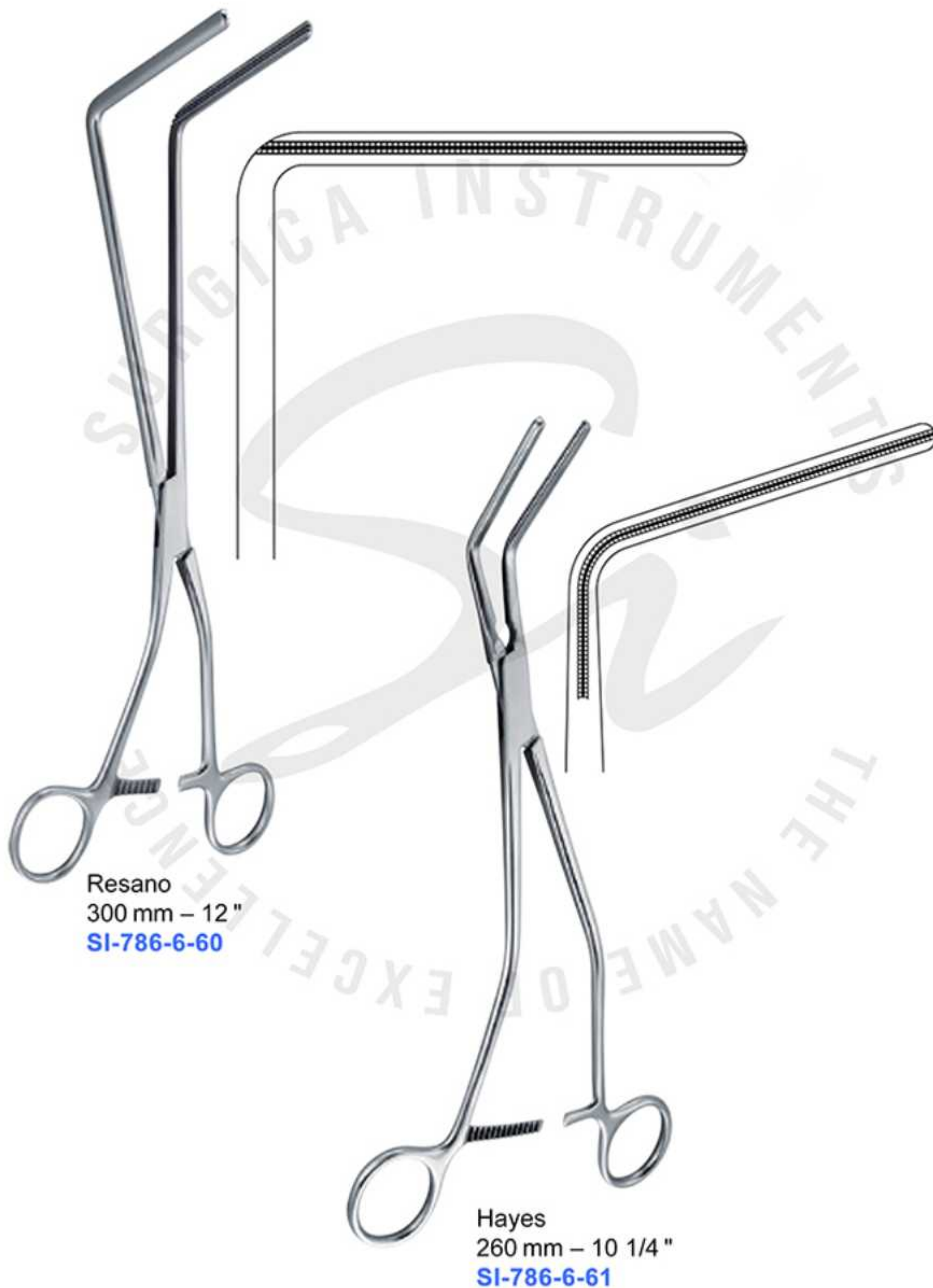

MAGEN, DARM – STOMACH, INTESTINES

Pinces-clamps pour l'intestin et l'estomac
Intestinal and stomach clamps
Pinzas-clamps para el intestino y el estomago
Pinze per intestino e stomaco

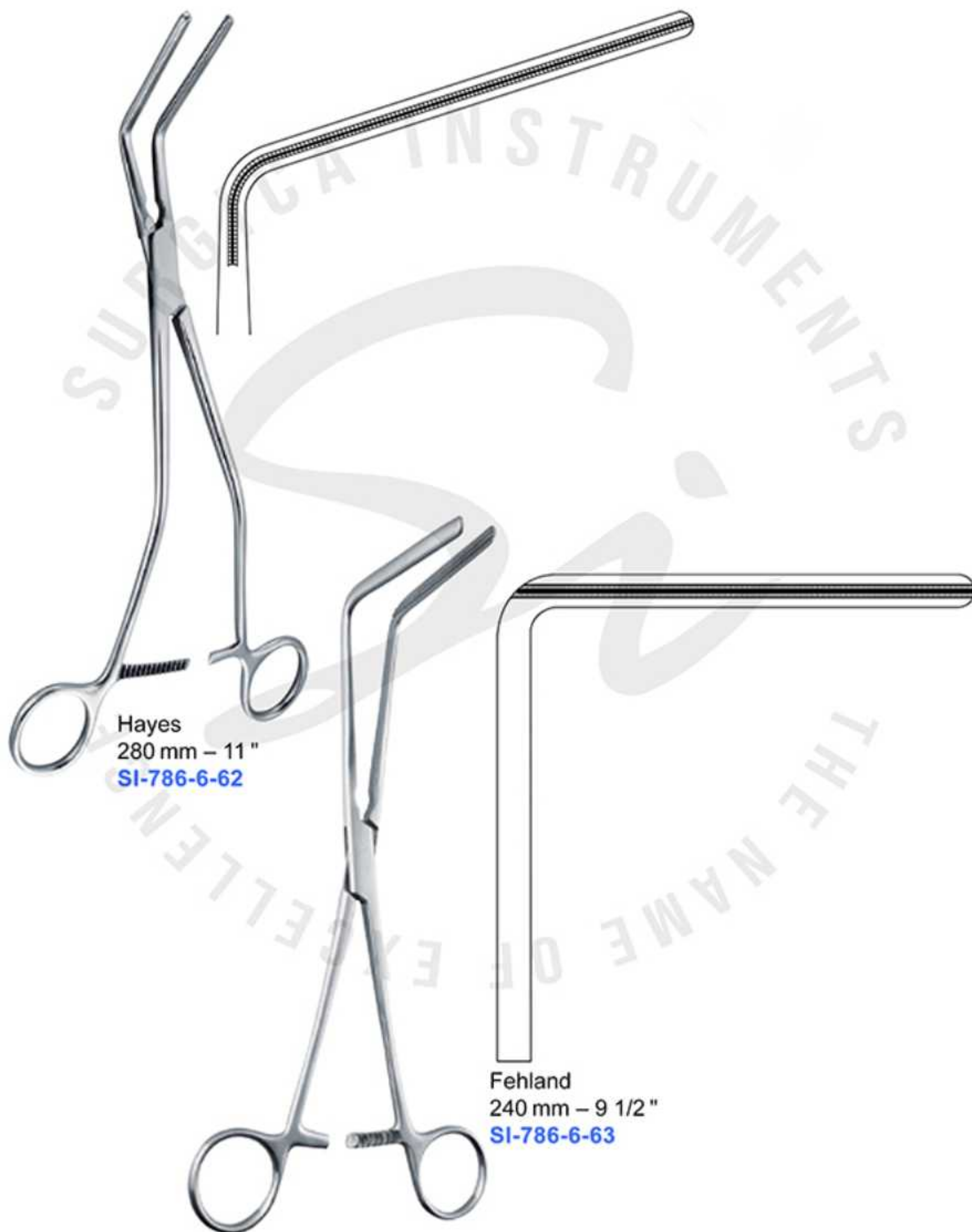

Hayes
280 mm – 11 "
SI-786-6-62

Fehland
240 mm – 9 1/2 "
SI-786-6-63

MAGEN, DARM – STOMACH, INTESTINES

Pinces-clamps pour l'intestin et l'estomac
Intestinal and stomach clamps
Pinzas-clamps para el intestino y el estomago
Pinze per intestino e stomaco



Brunner
240 mm – 9 1/2 "
SI-786-6-64

Organ grasping forceps
250 mm – 9 3/4 "
SI-786-6-65
Medium

Organ grasping forceps
260 mm – 10 1/4 "
SI-786-6-66
Large

Pinces-clamps pour l'intestin et l'estomac
Intestinal and stomach clamps
Pinzas-clamps para el intestino y el estomago
Pinze per intestino e stomaco



Payr-Baby
150 mm – 6 "
SI-786-6-67
with pin



Payr
210 mm – 8 1/4 "
SI-786-6-68
with pin



Payr
290 mm – 11 1/2 "
SI-786-6-69
with pin

Spéculums pour le rectum
Rectal specula
Espéculos rectales
Specoli rettali



Sims
150 mm –6"
x = 80 mm x 15 mm
SI-786-6-70



Sims
150 mm –6"
x = 80 mm x 15 mm
SI-786-6-70A



Sims
150 mm –6"
x = 80 mm x 15 mm
SI-786-6-71
Fenestrated



Sims
150 mm –6"
x = 80 mm x 15 mm
SI-786-6-71A
Fenestrated

Spéculums pour le rectum
Rectal specula
Espéculos rectales
Specoli rettali



Mathieu
195 mm – 7 3/4 "
x = 90 mm
SI-786-6-72



Pratt
205 mm – 8 "
x = 80 mm x 25 mm
SI-786-6-73



Czerny
220 mm – 8 3/4 "
x = 110 mm x 25 mm
SI-786-6-74

Spéculums pour le rectum
Rectal specula
Espéculos rectales
Specoli rettali



Smith-Buie
150 mm – 6 "
x = 75 mm x 23 mm
SI-786-6-75
Max. spread 115mm



Alan Parks
140 mm – 5 1/2 "
SI-786-6-76
complete with 2 pair of blades and
1 center blade, with cold light connector



Alan Parks
140 mm – 5 1/2 "
SI-786-6-77
complete with 2 pair of blades
and 1 center blade

Anusopes, Proctoscopes, Rectoscopes, Sphinctérosopes
Anusopes, Proctoscopes, Rectoscopes, Sphincterosopes
Anoscopios, Proctoscopios, Rectoscopios, Esfinteroscopios
Anoscopi, Proctoscopios, Rectoscopios, Sfinteroscopi



Ives-Fansler
22 mm x 90 mm **SI-786-6-75**
25 mm x 90 mm **SI-786-6-75A**



Fansler
25 mm x 65 mm **SI-786-6-76**
29 mm x 65 mm **SI-786-6-76A**
25 mm x 65 mm **SI-786-6-76B**
38 mm x 65 mm **SI-786-6-76C**



Bensaude
185 mm – 7 1/4"
20 mm x 55 mm **SI-786-6-77**
23 mm x 55 mm **SI-786-6-77A**



Kelly
21 mm x 50 mm **SI-786-6-78**
22 mm x 50 mm **SI-786-6-78A**
27 mm x 50 mm **SI-786-6-78B**

Anoscopes, Proctoscopes, Rectoscopes, Sphinctérosopes
Anuscosopes, Proctoscopes, Rectoscopes, Sphincteroscopes
Anoscopios, Proctoscopios, Rectoscopios, Esfinteroscopios
Anoscopi, Proctoscopios, Rectoscopios, Sfinteroscopi



Kelly
22 x 50 mm **SI-786-6-79**
22 x 100 mm **SI-786-6-79A**
22 x 140 mm **SI-786-6-79B**
22 x 200 mm **SI-786-6-79C**



Hirschmann
16 mm Ø x 65 mm **SI-786-6-80**
19 mm Ø x 65 mm **SI-786-6-80A**
22 mm Ø x 65 mm **SI-786-6-80B**
25 mm Ø x 65 mm **SI-786-6-80C**



Hirschmann
16 mm Ø x 65 mm **SI-786-6-81**
19 mm Ø x 65 mm **SI-786-6-81A**
22 mm Ø x 65 mm **SI-786-6-81B**
25 mm Ø x 65 mm **SI-786-6-81C**

Anusopes, Proctosopes, Rectosopes, Sphinctéscopes
Anusopes, Proctosopes, Rectosopes, Sphincterosopes
Anoscopios, Proctoscopios, Rectoscopios, Esfinteroscopios
Anoscopi, Proctoscopios, Rectoscopios, Sfinteroscopi



Proctoscope
22 mm Ø x 65 mm **SI-786-6-818**



Chelsea Eaton
22 mm Ø x 65 mm **SI-786-6-819**
30 mm Ø x 65 mm **SI-786-6-819A**

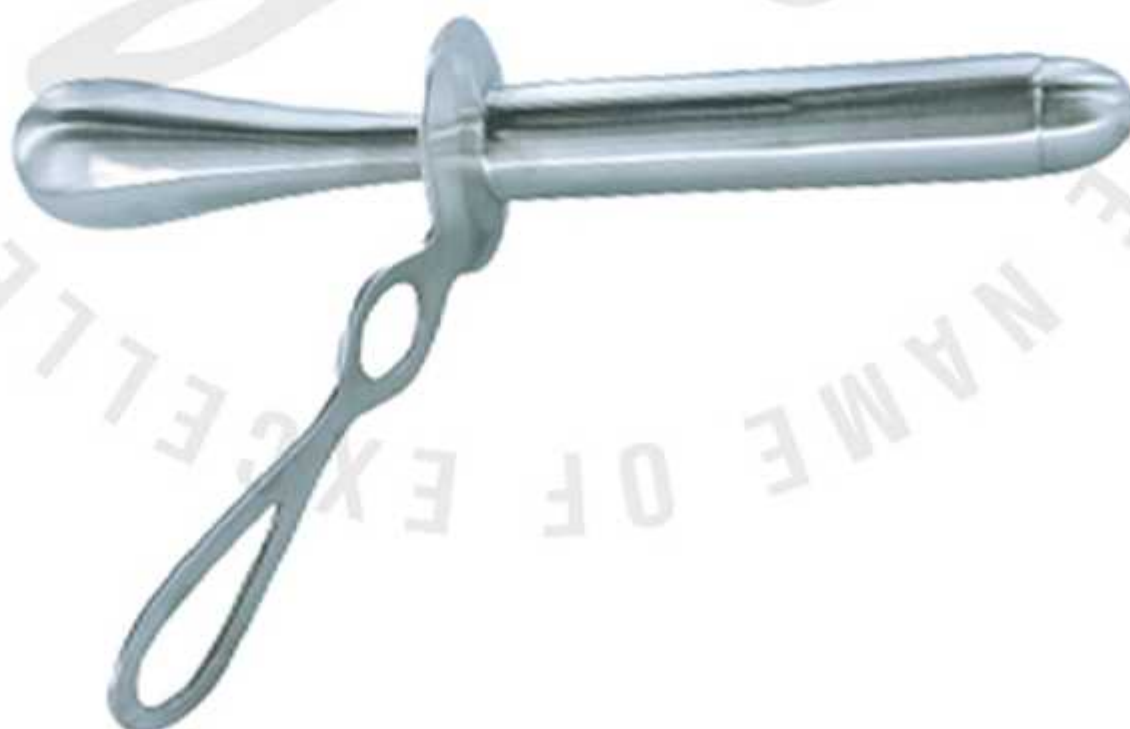

Kelly
22 x 50 mm **SI-786-6-820**
22 x 100 mm **SI-786-6-820A**
22 x 140 mm **SI-786-6-820B**

Anusopes, Proctoscopes, Rectoscopes, Sphinctérosopes
Anusopes, Proctoscopes, Rectoscopes, Sphincterosopes
Anoscopios, Proctoscopios, Rectoscopios, Esfinteroscopios
Anoscopi, Proctoscopios, Rectoscopios, Sfinteroscopi



Brinckerhoff Specula
Small [SI-786-6-822](#)
Medium [SI-786-6-822A](#)
Large [SI-786-6-822B](#)

Fansler
25 mm Ø x 65 mm [SI-786-6-821](#)
29 mm Ø x 65 mm [SI-786-6-821A](#)
38 mm Ø x 65 mm [SI-786-6-821B](#)



Yankauer Nasopharyngeal Speculum 19 cm
[SI-786-6-823](#)

Anuscopes, Proctoscopes, Rectoscopes, Sphinctérosopes
Anuscopes, Proctoscopes, Rectoscopes, Sphincteroscopes
Anoscopios, Proctoscopios, Rectoscopios, Esfinteroscopios
Anoscopi, Proctoscopios, Rectoscopios, Sfinteroscopi



Morgan
17 x 65 mm [SI-786-6-824](#)
17 x 80 mm [SI-786-6-824A](#)
20 x 65 mm [SI-786-6-824B](#)
20 x 80 mm [SI-786-6-824C](#)
24 x 65 mm [SI-786-6-824D](#)
24 x 80 mm [SI-786-6-824E](#)

Gebriel Rectal Speculum
19 x 49 mm [SI-786-6-825](#)
24 x 64 mm [SI-786-6-825A](#)

Kelly
22 x 75 mm [SI-786-6-826](#)
22 x 100 mm [SI-786-6-826A](#)
22 x 140 mm [SI-786-6-826B](#)

Pincas hémorroidales
Haemorrhoidal forceps
Pinzas hemorroidales
Pinze emorroidali



Luer
245 mm – 9 3/4 "
SI-786-6-78



Mc Givney
190 mm – 7 1/2 "
SI-786-6-79
Single curved



Mc Givney
190 mm – 7 1/2 "
SI-786-6-80
Double curved

Pinces hémorroidales
Haemorrhoidal forceps
Pinzas hemorroidales
Pinze emorroidali



Heywood-Smith
200 mm – 8 "
SI-786-6-81



Heywood-Smith
210 mm – 8 1/4 "
SI-786-6-82

Ligateurs hémorroïdales
Haemorrhoidal ligators
Ligadores hemorroidales
Legatori emorroidali



Lurz
x = 8 mm Ø **SI-786-6-83**
x = 10 mm Ø **SI-786-6-83A**
Complete



Mc Givney
x = 10 mm Ø
SI-786-6-84
Complete

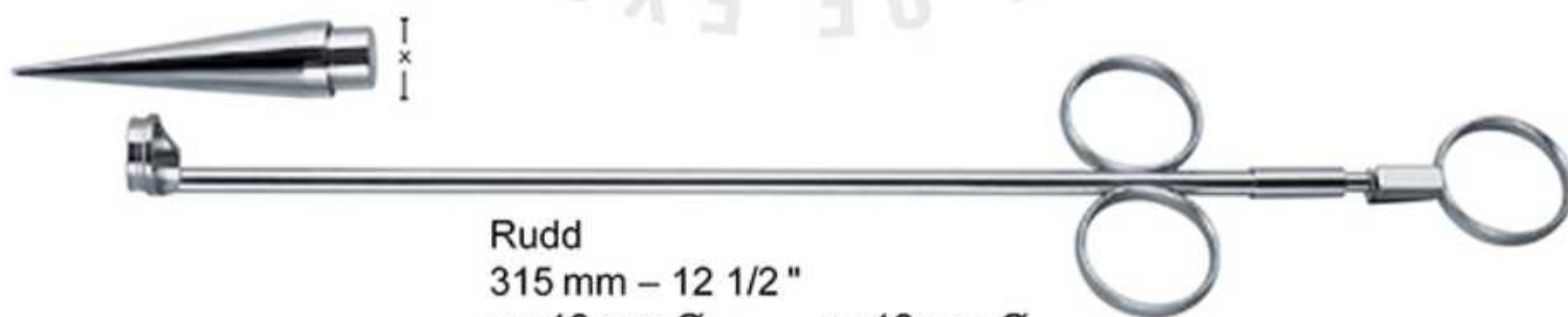

Rudd
315 mm – 12 1/2 "
x = 12 mm Ø x = 12 mm Ø
SI-786-6-85 **SI-786-6-85A**
Complete Cone piece only

S*i* SURGICA
INSTRUMENTS
THE NAME OF EXCELLENCE



WUNDHAKEN – RETRACTORS

- NASAL HOOKS
- TRACHEA AND NOSE RETRACTOR
- GENERAL WUNDHAKEN RETRACTOR
- SELF-RETAINING RETRACTORS
- ABDOMINAL RETRACTORS
- LAMINECTOMY RETRACTORS
- ABDOMINAL SPATULAS
- & MORE

WUNDHAKEN – RETRACTORS

Crochets nasales
Nasal hooks
Ganchitos nasales
Uncini nasali

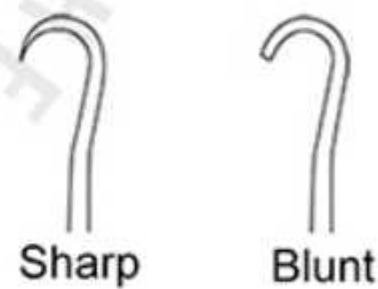
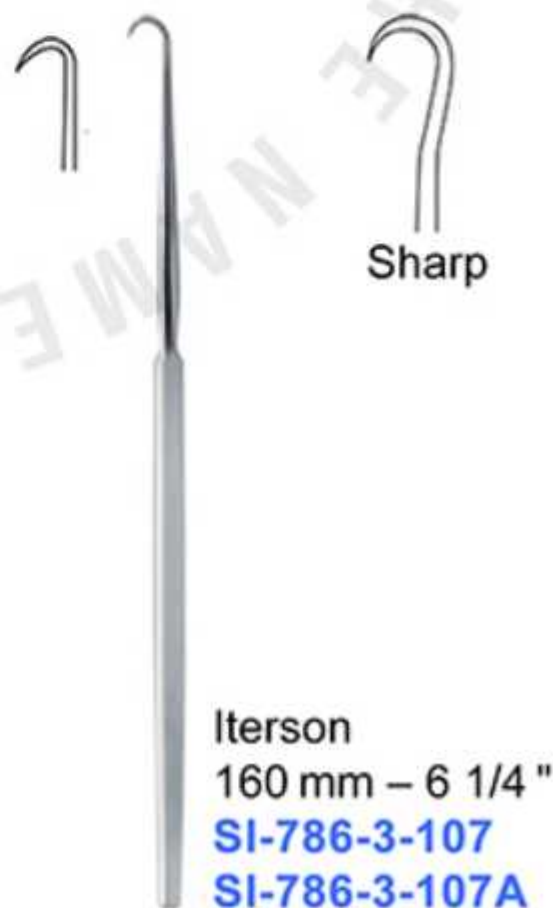

WUNDHAKEN - RETRACTORS

Crochets nasales
Nasal hooks
Ganchitos nasales
Uncini nasali

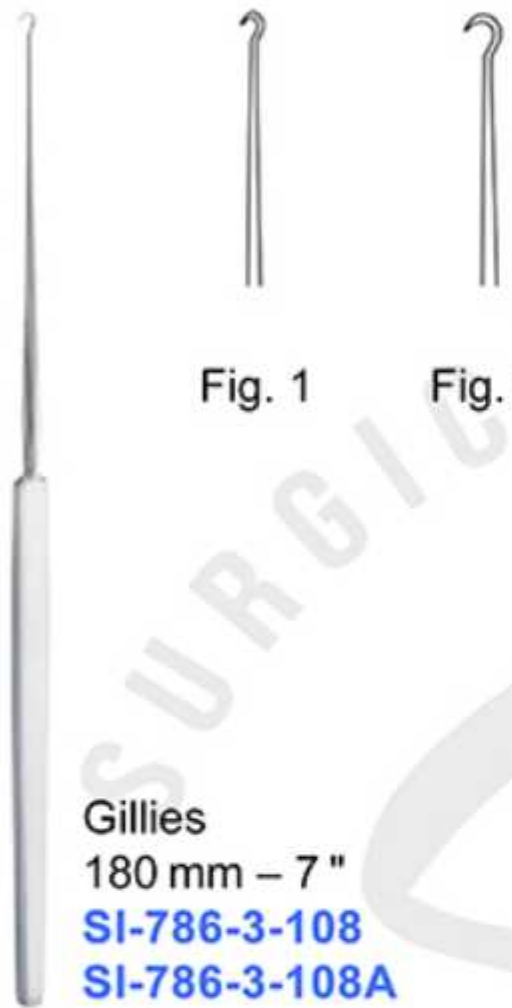
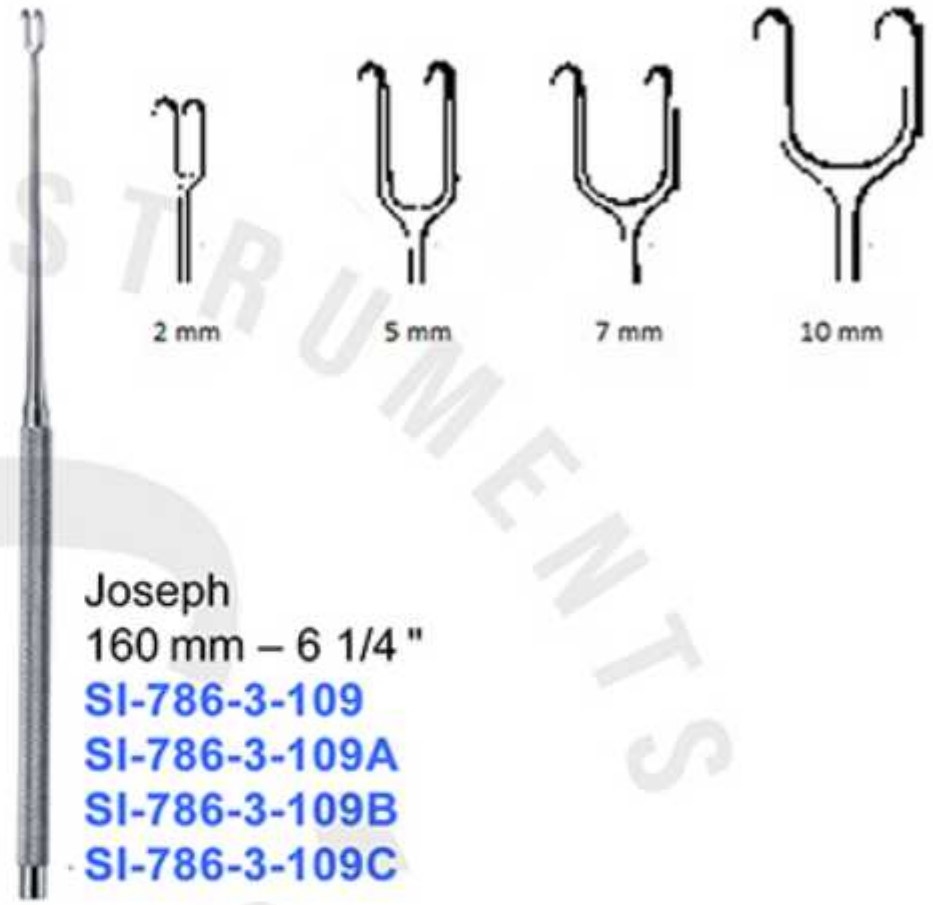

Fig. 1

Fig. 2

Gillies
180 mm – 7"
SI-786-3-108
SI-786-3-108A



Joseph
160 mm – 6 1/4"
SI-786-3-109
SI-786-3-109A
SI-786-3-109B
SI-786-3-109C



Cottle-Neivert
200 mm – 8"
SI-786-3-110



Fomon
160 mm – 6 1/4"
SI-786-3-111



Cottle
150 mm – 6"
SI-786-3-112
SI-786-3-112A
SI-786-3-112B



A



B



C



Neivert
160 mm – 6 1/4"
SI-786-3-113

WUNDHAKEN - RETRACTORS

Ecarteurs nasales et tracheales
Trachea and nose retractors
Separadores traqueales y nasales
Uncini tracheali e nasali



Cottle
150 mm – 6 "
SI-786-3-114



Cottle
150 mm – 6 "
SI-786-3-115



Kilner
100 mm – 4 "
SI-786-3-116



Converse
120 mm – 4 3/4 "
SI-786-3-117



Lukens
170 mm – 6 2/3 "
SI-786-3-118
Blunt



Aufricht
160 mm – 7 1/4 "
190 mm – 7 1/2 "
SI-786-3-119



Aufricht
160 mm – 7 1/4 "
190 mm – 7 1/2 "
SI-786-3-120

Ecarteurs tracheales
Trachea retractors
Separadores traqueales
Uncini tracheali



Jackson
170 mm – 6 2/3 "
SI-786-3-121



Jackson
150 mm – 6 "
SI-786-3-122



Jackson
180 mm – 7 "
SI-786-3-123
Sharp / Blunt



Rose
130 mm – 5 "
SI-786-3-124



Luer
110 mm – 4 1/4 "
SI-786-3-125



Schoenborn
210 mm – 8 1/4 "
SI-786-3-126

Ecarteurs
Retractors
Separadores
Divaricatori

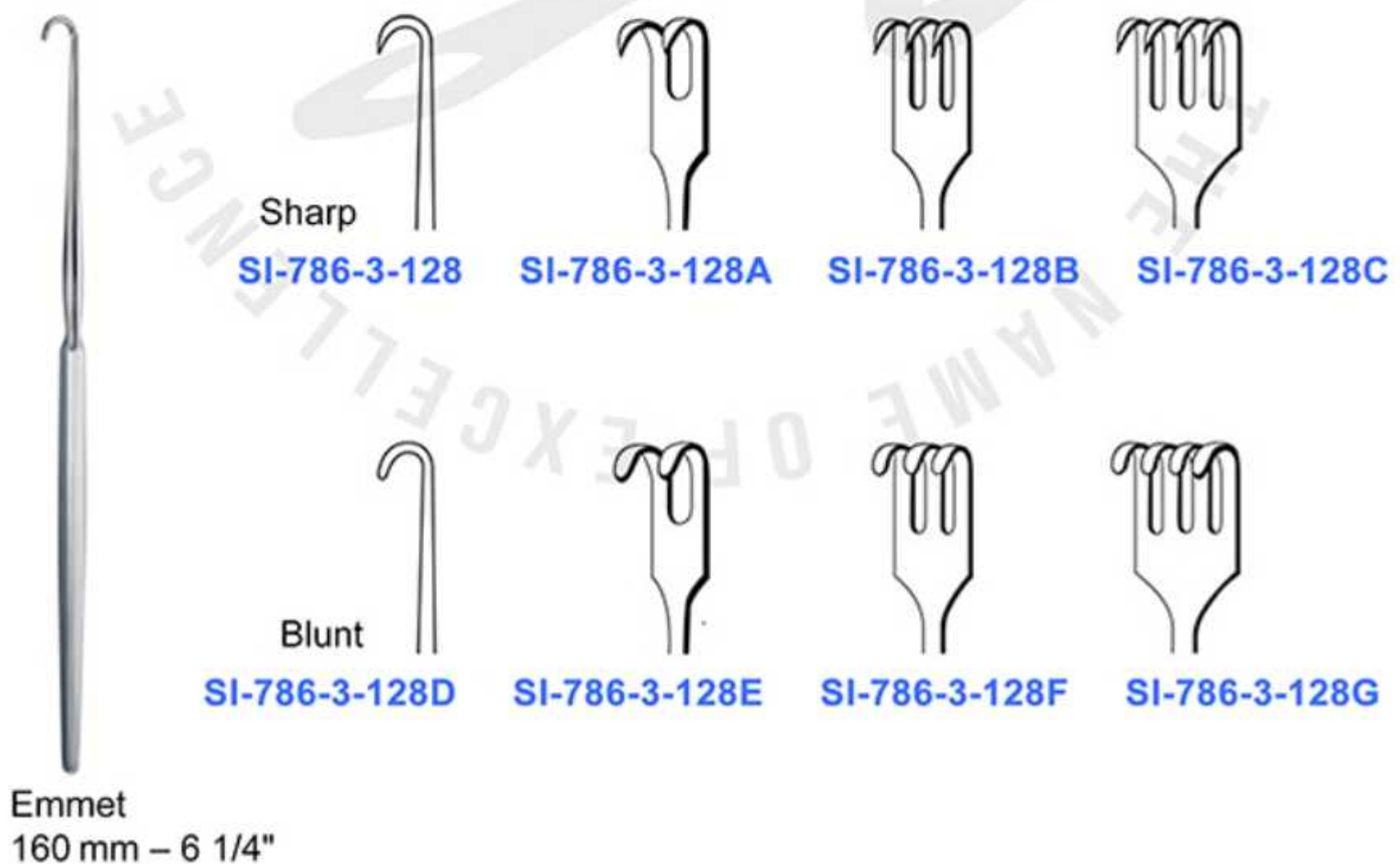
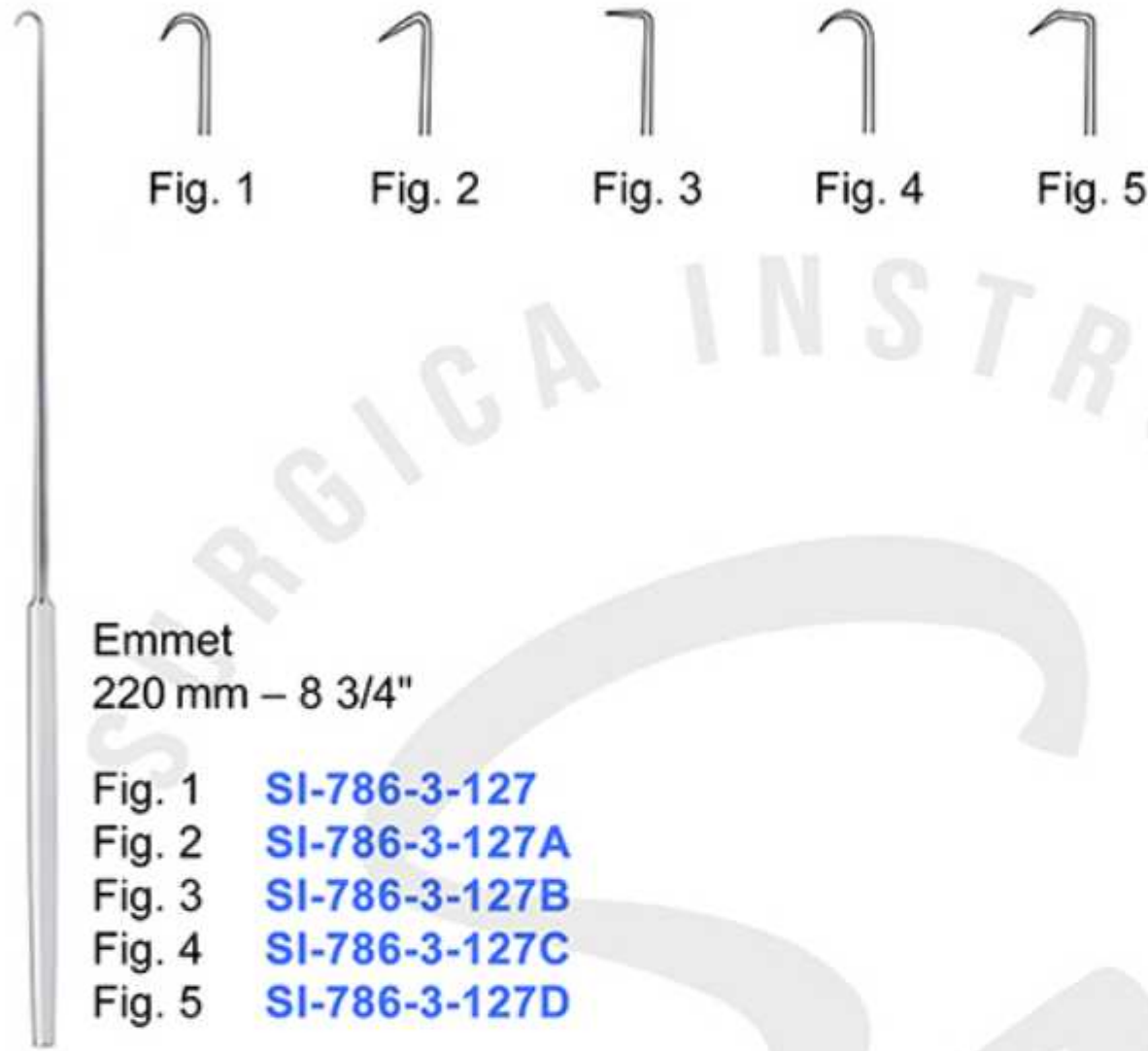

Ecarteurs
Retractors
Separadores
Divaricatori



Flexible, Sharp



SI-786-3-129 SI-786-3-129A SI-786-3-129B

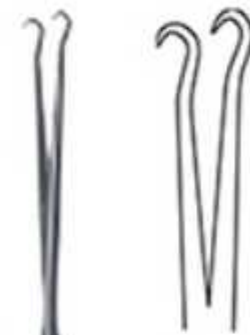

Flexible, Blunt



SI-786-3-129C SI-786-3-129D SI-786-3-129E

Emmet
160 mm – 6 1/4"

Barsky
155 mm – 6"
SI-786-3-130



Desmarres
160 mm – 6 1/4"



x = 8 mm



x = 10 mm



x = 12 mm



x = 14 mm



x = 16 mm



x = 18 mm

x = 8 mm SI-786-3-131
x = 10 mm SI-786-3-131A
x = 12 mm SI-786-3-131B
x = 14 mm SI-786-3-131C
x = 16 mm SI-786-3-131D
x = 16 mm SI-786-3-131E



Flexible, Sharp

Knapp Rollet
160 mm – 6 1/4"
SI-786-3-132

WUNDHAKEN - RETRACTORS

Ecarteurs
Retractors
Separadores
Divaricatori

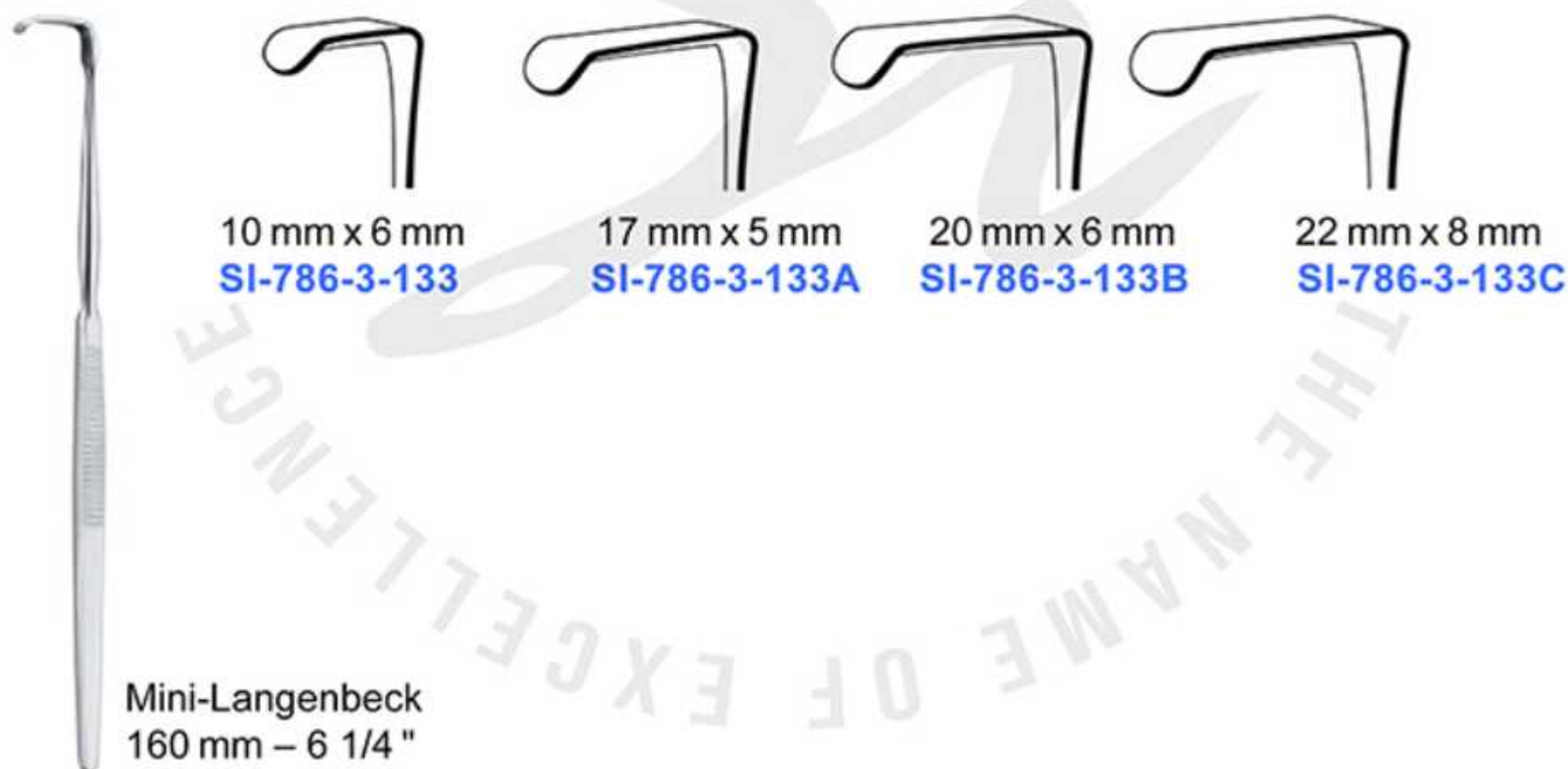

Ecarteurs
Retractors
Separadores
Divaricatori



SI-786-3-134 SI-786-3-134A SI-786-3-134B SI-786-3-134C SI-786-3-134D SI-786-3-134E



SI-786-3-134F SI-786-3-134G SI-786-3-134H SI-786-3-134I SI-786-3-134J SI-786-3-134K



SI-786-3-134L SI-786-3-134M SI-786-3-134N SI-786-3-134O SI-786-3-134P SI-786-3-134Q

Kocher
220 mm - 8 3/4"

WUNDHAKEN – RETRACTORS

Ecarteurs
Retractors
Separadores
Divaricatori

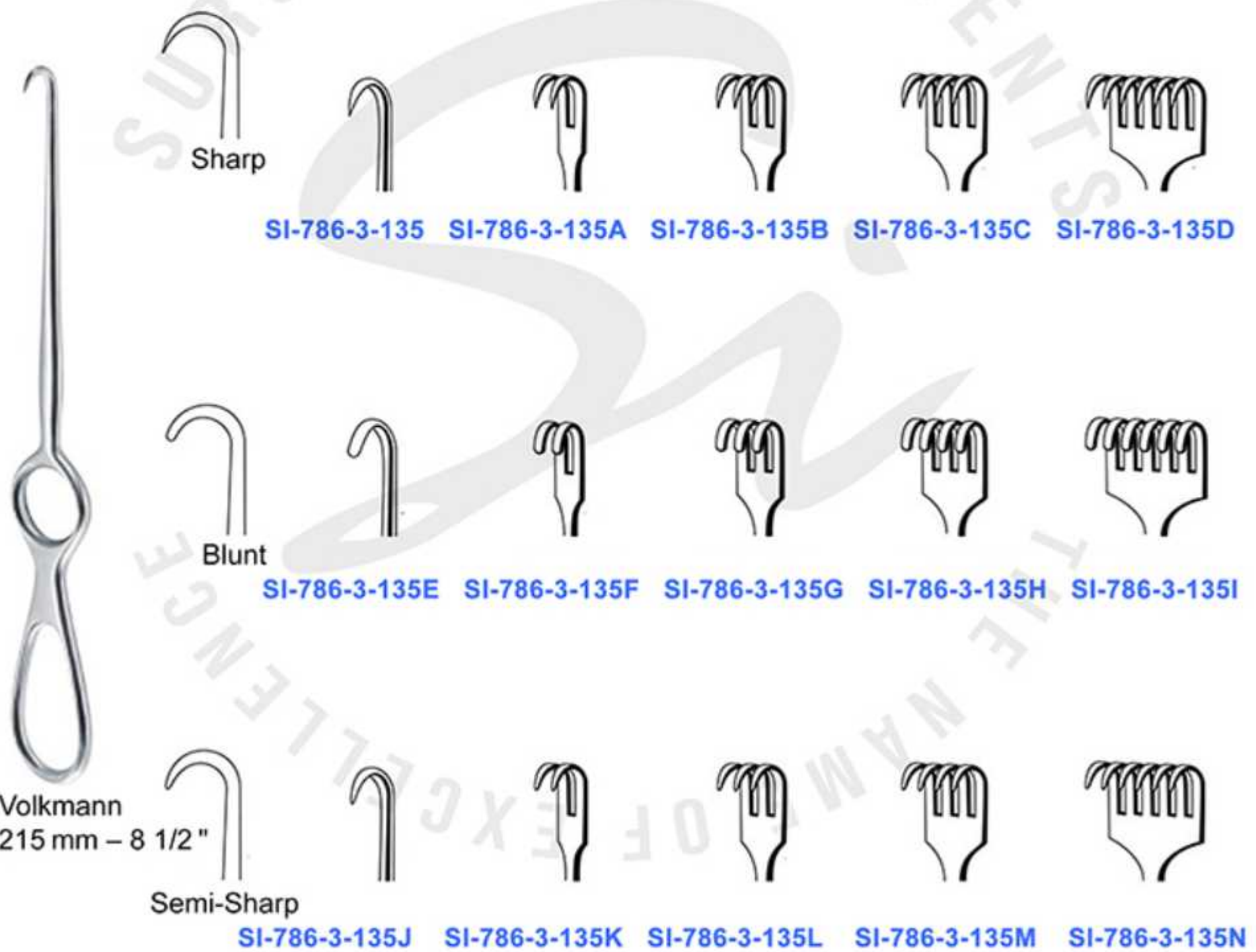

WUNDHAKEN - RETRACTORS

Ecarteurs
Retractors
Separadores
Divaricatori



Volkman
215 mm – 8 1/2 "

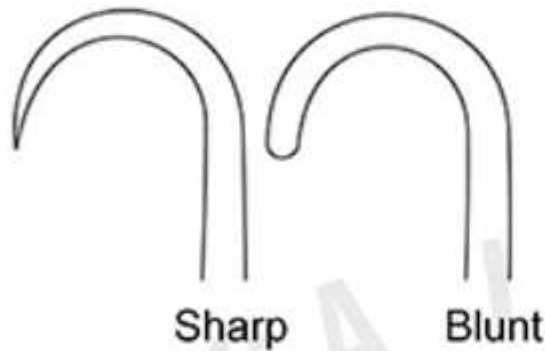

Sharp SI-786-3-136
Blunt SI-786-3-136A



Senn-Miller
160 mm – 6 1/4 "

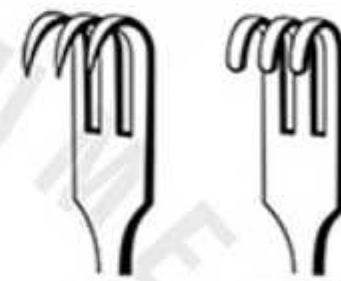

Sharp SI-786-3-137
Blunt SI-786-3-137A



Kilner
155 mm – 6 "

13 mm x 5 mm
SI-786-3-138



Strandell-Stille
190 mm – 7 1/2 "



20 mm x 6 mm SI-786-3-139
20 mm x 6 mm SI-786-3-139A

WUNDHAKEN - RETRACTORS

Ecarteurs
Retractors
Separadores
Divaricatori



Senn-Green
150 mm - 6"



20 mm x 6 mm
SI-786-3-140



10 mm x 6 mm
SI-786-3-140



Ragnell-Davis
140 mm - 5 1/2"
SI-786-3-141



8 mm x 4 mm

15 mm x 5,5 mm



Cottle
150 mm - 6"
SI-786-3-142



Crile
110 mm - 4 1/4"
SI-786-3-143



Middeldorpf



14 mm x 17 mm
215 mm - 8 1/2"
SI-786-3-144



20 mm x 22 mm
220 mm - 8 3/4"
SI-786-3-144A

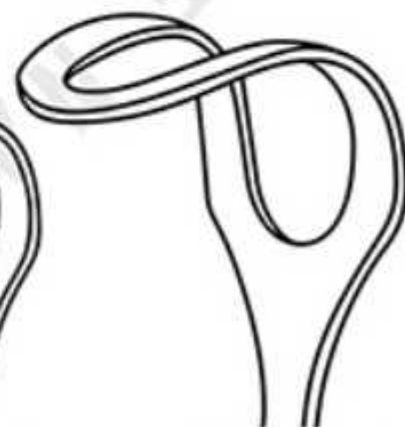

26 mm x 30 mm
235 mm - 9 1/4"
SI-786-3-144B

WUNDHAKEN - RETRACTORS

Ecarteurs
Retractors
Separadores
Divaricatori



Ecarteurs
Retractors
Separadores
Divaricatori



Ecarteurs
Retractors
Separadores
Divaricatori



Kocher-Langenbeck (Obwegeser)
215 mm – 8 1/2"



Cushing
200 mm – 8"
240 mm – 9 1/2"



Ecarteurs
Retractors
Separadores
Divaricatori



42 mm x 13 mm
SI-786-3-153

60 mm x 12 mm
SI-786-3-153A

80 mm x 16 mm
SI-786-3-153B

Obwegeser
220 mm – 8 3/4 "



44 mm x 9,5 mm
SI-786-3-154

70 mm x 11,5 mm
SI-786-3-154A

Obwegeser
220 mm – 8 3/4 "

Ecarteurs
Retractors
Separadores
Divaricatori



Obwegeser
155 mm – 6 "
SI-786-3-155



Obwegeser
160 mm – 6 1/4 "
SI-786-3-156
Malleable

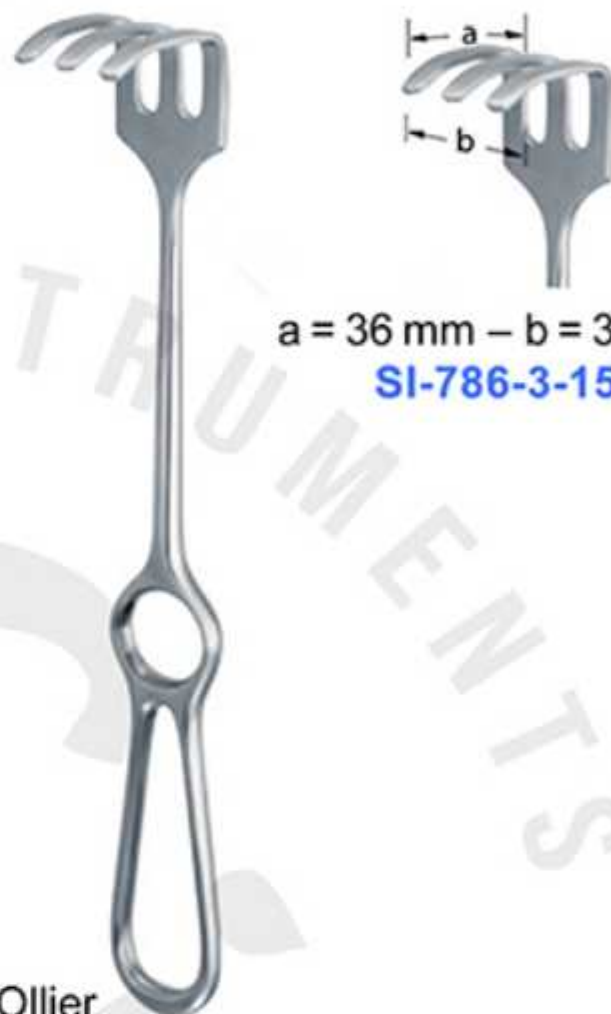

a = 36 mm – b = 30 mm
SI-786-3-157

Ollier
225 mm – 8 3/4 "



a = 36 mm – b = 60 mm
SI-786-3-158

Ollier
225 mm – 8 3/4 "



Kocher
210 mm – 8 1/4 "
55 mm x 11 mm SI-786-3-159
40 mm x 12 mm SI-786-3-159A

WUNDHAKEN - RETRACTORS

Ecarteurs
Retractors
Separadores
Divaricatori

60 mm x 20 mm



Langenbeck
210 mm – 8 1/4 "
SI-786-3-160

85 mm x 15 mm



Langenbeck
210 mm – 8 1/4 "
Handle vertical to the blade
SI-786-3-161

45 mm x 15 mm
SI-786-3-162

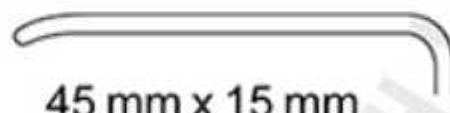

60 mm x 23 mm
SI-786-3-162A



75 mm x 20 mm
SI-786-3-162B

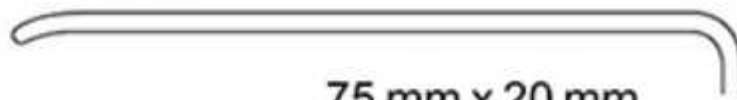

Sauerbruch
225 mm – 8 3/4 "
220 mm – 8 3/4 "



WUNDHAKEN - RETRACTORS

Ecarteurs
Retractors
Separadores
Divaricatori



Lahey
190 mm – 7 1/2 "
SI-786-3-163



Kocher
190 mm – 7 1/2 "



19 mm x 12 mm
SI-786-3-164

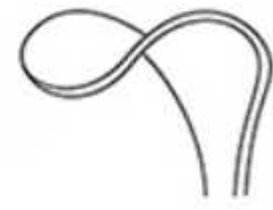

21 mm x 14 mm
SI-786-3-164A



Kocher
220 mm – 8 3/4 "
40 mm x 10 mm
40 mm x 15 mm
40 mm x 20 mm



40 mm x 10 mm 40 mm x 15 mm 40 mm x 20 mm

SI-786-3-165
SI-786-3-165A
SI-786-3-165B

WUNDHAKEN - RETRACTORS

Ecarteurs
Retractors
Separadores
Divaricatori



Kocher
230 mm - 9"

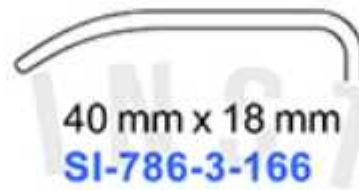

40 mm x 18 mm
SI-786-3-166



60 mm x 20 mm
SI-786-3-166A



60 mm x 25 mm
SI-786-3-166B



75 mm x 30 mm
SI-786-3-166C



75 mm x 40 mm
SI-786-3-166D



Richardson
240 mm - 9 1/2"



28 mm x 20 mm
SI-786-3-167

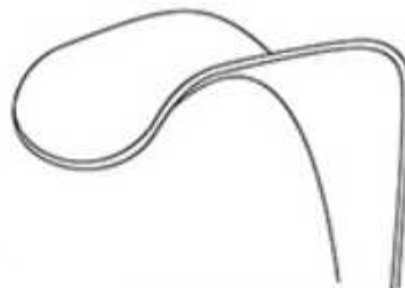

36 mm x 28 mm
SI-786-3-167A

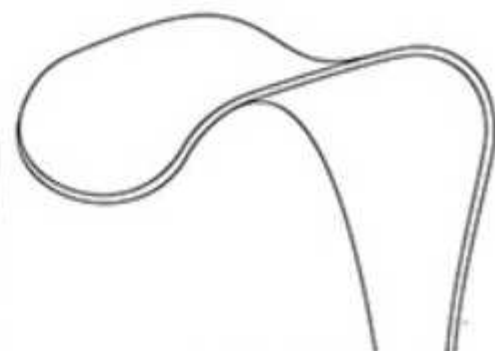

44 mm x 38 mm
SI-786-3-167B

Ecarteurs
Retractors
Separadores
Divaricatori



Richardson-Eastman

Fig. 1

280 mm – 11 "

SI-786-3-168

49 x 38 mm

63 x 49 mm



Fig. 2

260 mm – 10 1/4 "

SI-786-3-168A

36 x 28 mm

28 x 20 mm

Richardson
240 mm – 9 1/2 "
52 mm x 22 mm
SI-786-3-169



Kelly
260 mm – 10 1/4 "
65 mm x 50 mm
SI-786-3-170

WUNDHAKEN – RETRACTORS

Ecarteurs
Retractors
Separadores
Divaricatori



Hoesel
260 mm – 10 1/4"



63 mm x 21 mm
SI-786-3-171

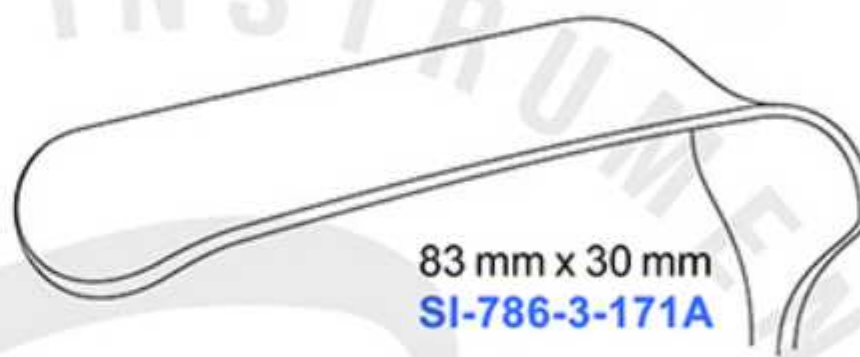

83 mm x 30 mm
SI-786-3-171A

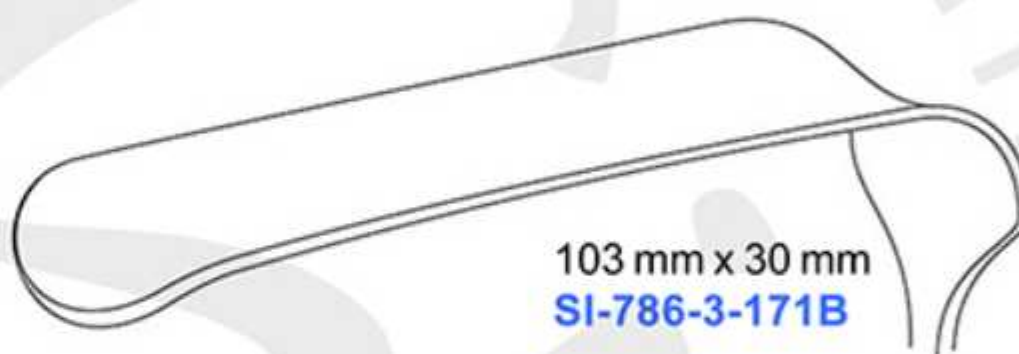

103 mm x 30 mm
SI-786-3-171B



Meyerding

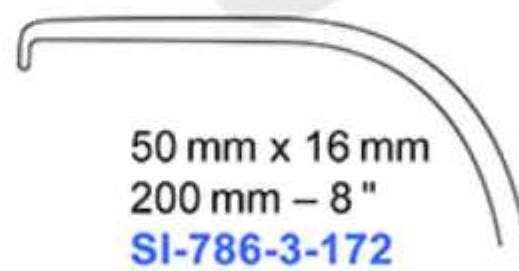

50 mm x 16 mm
200 mm – 8"
SI-786-3-172

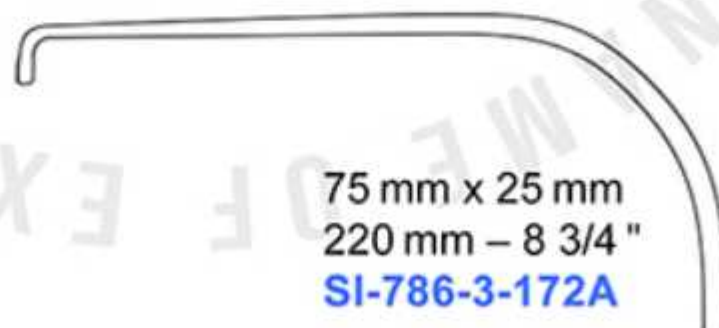

75 mm x 25 mm
220 mm – 8 3/4"
SI-786-3-172A

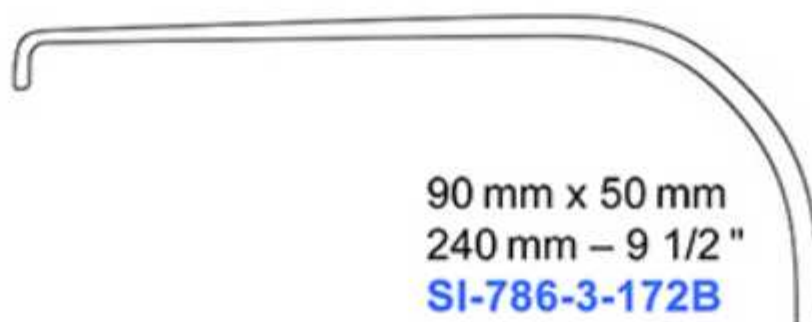

90 mm x 50 mm
240 mm – 9 1/2"
SI-786-3-172B

Ecarteurs
Retractors
Separadores
Divaricatori



Simon
280 cm – 11 "
115 mm x 22 mm
115 mm x 27 mm

SI-786-3-174
SI-786-3-174A



Harrington
320 mm – 12 1/2 "
127 mm x 40 mm
127 mm x 62 mm

SI-786-3-175
SI-786-3-175A

Ecarteurs
Retractors
Separadores
Divaricatori



95 mm x 35 mm
SI-786-3-176

120 mm x 50 mm
SI-786-3-176A

Mikulicz
260 mm – 10 1/4 "



Mikulicz
260 mm – 10 1/4 "
90 mm x 50 mm
SI-786-3-177

Ecarteurs
Retractors
Separadores
Divaricatori



Kelly
270 mm – 10 3/4"
190 mm x 38 mm
190 mm x 57 mm

SI-786-3-179
SI-786-3-179A



Davidson
160 mm – 6 1/4"
a = 75 mm – b = 50 mm
a = 75 mm – b = 90 mm

SI-786-3-178
SI-786-3-178A



Kader
270 mm
x = 20 mm
x = 30 mm
x = 40 mm

SI-786-3-180
SI-786-3-180A
SI-786-3-180B

WUNDHAKEN - RETRACTORS

Ecarteurs
Retractors
Separadores
Divaricatori

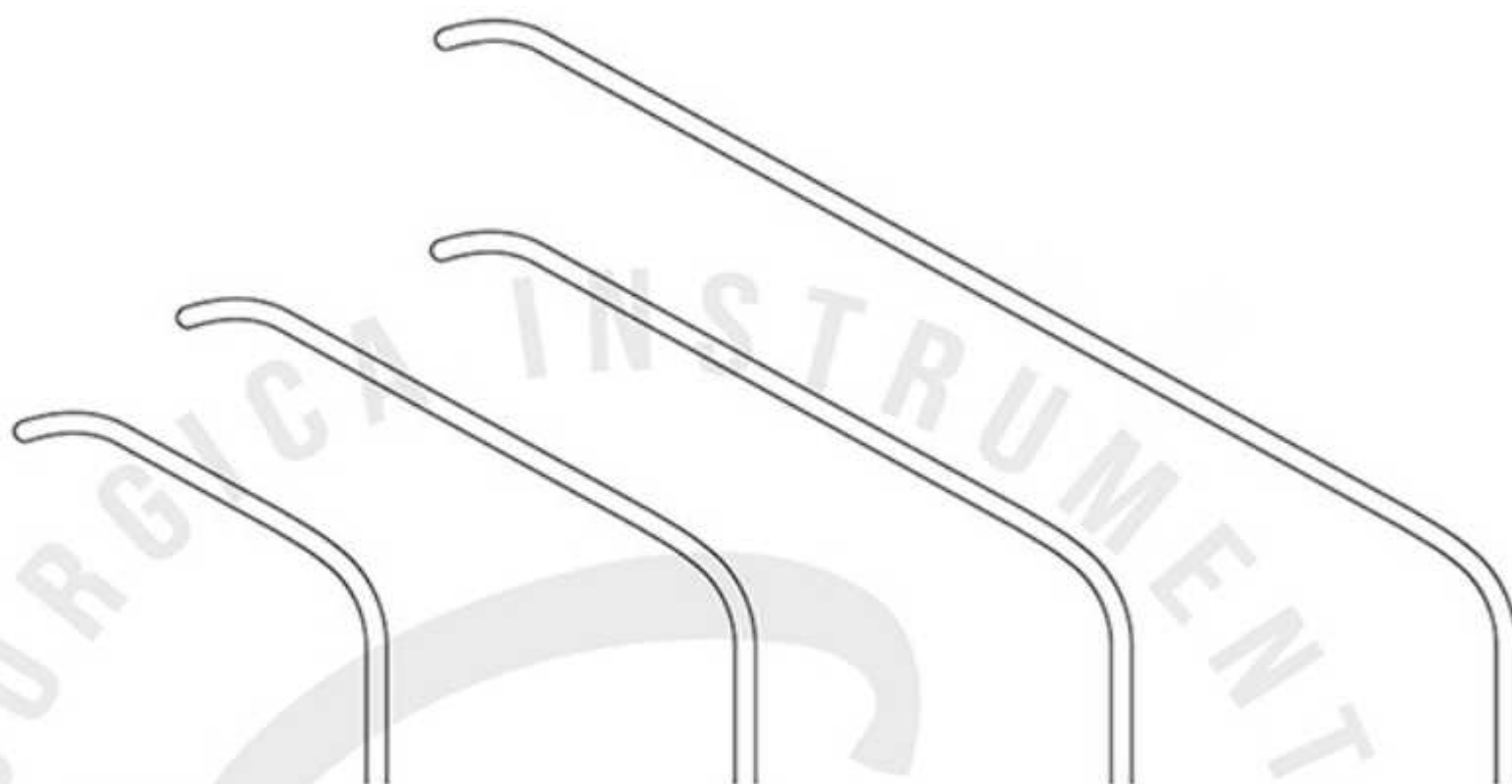

Zenker

250 mm – 9 3/4 "	260 mm – 10 1/4 "	275 mm – 10 3/4 "	290 mm – 11 1/2 "
35 mm x 8 mm	60 mm x 12 mm	75 mm x 12 mm	120 mm x 12 mm
SI-786-3-181	SI-786-3-181A	SI-786-3-181B	SI-786-3-181



Cooley
250 mm – 9 3/4 "
SI-786-3-182
Right



Cooley
250 mm – 9 3/4 "
SI-786-3-183
Right , Serrated



Cooley
270 mm – 10 1/2 "
SI-786-3-184
Left

Ecarteurs
Retractors
Separadores
Divaricatori



Middeldorpf
255 mm – 10"



45 mm x 45 mm
SI-786-3-185



45 mm x 50 mm
SI-786-3-185A



55 mm x 70 mm
SI-786-3-185B

Ecarteurs
Retractors
Separadores
Divaricatori



Doyen
250 mm – 9 3/4 "
50 mm x 85 mm
SI-786-3-186

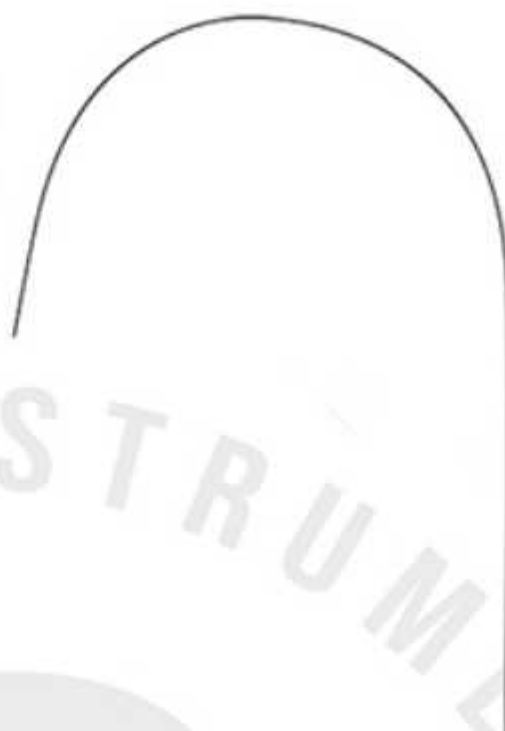

Kocher
250 mm – 9 3/4 "
80 mm x 45 mm **SI-786-3-188**
80 mm x 55 mm **SI-786-3-188A**
80 mm x 65 mm **SI-786-3-188B**



Kocher
225 mm – 8 3/4 "
70 mm x 25 mm
SI-786-3-187

Ecarteurs
Retractors
Separadores
Divaricatori



Tuffier
230 mm – 9"
64 mm x 60 mm
SI-786-3-189



Martin
250 mm – 9 3/4"
105 mm x 27 mm
SI-786-3-190



Sauerbruch
250 mm – 9 3/4"
125 mm x 37 mm
SI-786-3-191

WUNDHAKEN – RETRACTORS

Ecarteurs
Retractors
Separadores
Divaricatori

45 mm x 25 mm
SI-786-3-192

73 mm x 28 mm
SI-786-3-192A

82 mm x 28 mm
SI-786-3-192C

Heaney
270 mm – 10 3/4 "

82 mm x 22 mm
SI-786-3-193

108 mm x 43 mm
SI-786-3-193A

115 mm x 65 mm
SI-786-3-193B

Coryllos
240 mm – 9 1/2 "

WUNDHAKEN - RETRACTORS

Ecarteurs
Retractors
Separadores
Divaricatori



Brunner
250 mm – 9 3/4"

80 mm x 20 mm
SI-786-3-194

100 mm x 20 mm
SI-786-3-194A

120 mm x 25 mm
SI-786-3-194B

140 mm x 25 mm
SI-786-3-194C

Ecarteurs
Retractors
Separadores
Divaricatori

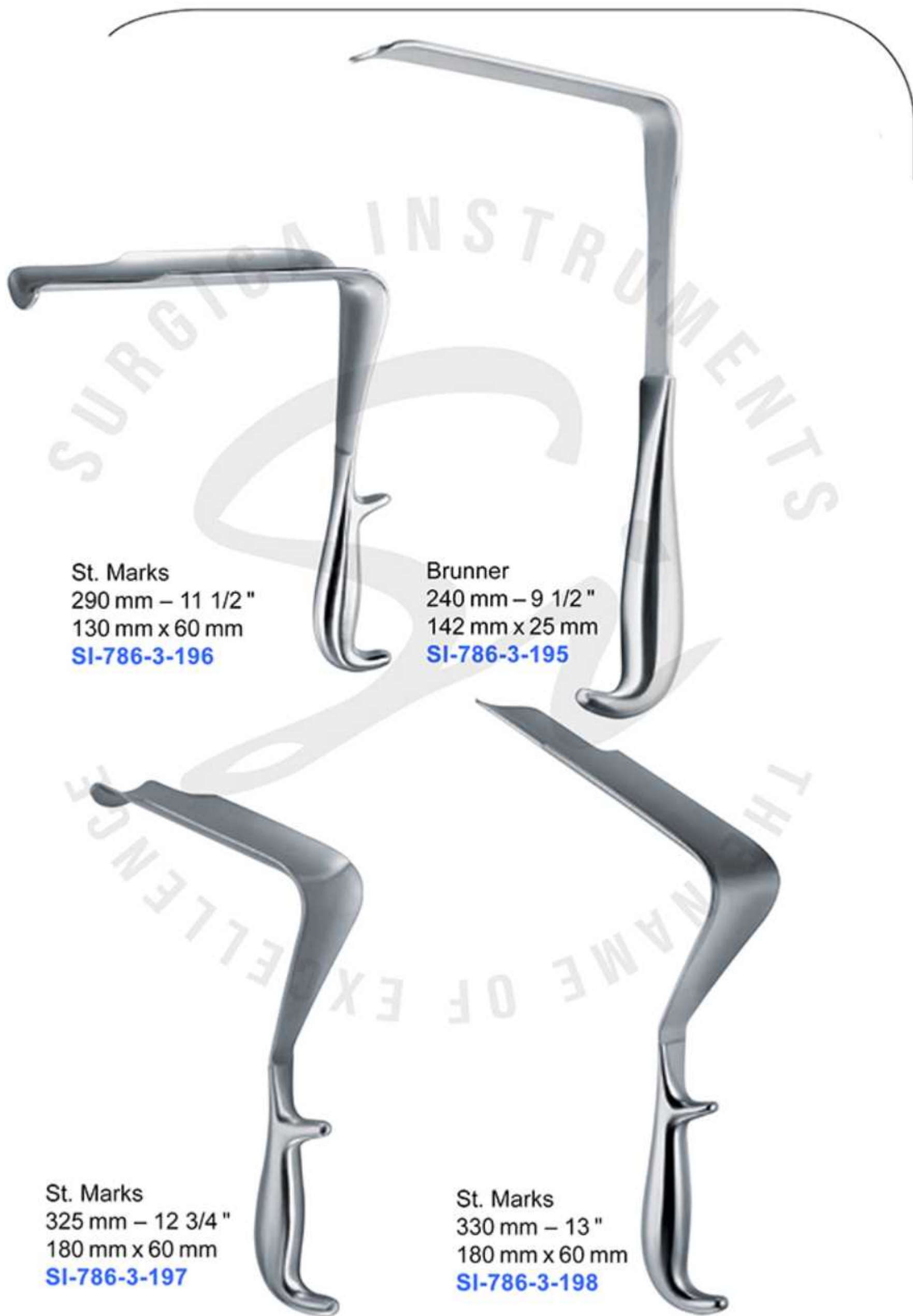

St. Marks
290 mm – 11 1/2"
130 mm x 60 mm
SI-786-3-196

Brunner
240 mm – 9 1/2"
142 mm x 25 mm
SI-786-3-195

St. Marks
325 mm – 12 3/4"
180 mm x 60 mm
SI-786-3-197

St. Marks
330 mm – 13"
180 mm x 60 mm
SI-786-3-198

WUNDHAKEN – RETRACTORS

Ecarteurs
Retractors
Separadores
Divaricatori



Cushing
200 mm – 8 "
SI-786-3-199



Koerte
280 mm – 11 "
120 mm x 47 mm
SI-786-3-200



Morris
210 mm – 8 1/4 "
50 mm x 55 mm
SI-786-3-201



Morris
245 mm – 9 3/4 "
70 mm x 40 mm
70 mm x 50 mm
70 mm x 65 mm

SI-786-3-202
SI-786-3-202A
SI-786-3-202B

Ecarteurs
Retractors
Separadores
Divaricatori



Deaver
315 mm – 12 1/2"

x = 25 mm
SI-786-3-203

x = 38 mm
SI-786-3-203A

x = 50 mm
SI-786-3-203B

x = 75 mm
SI-786-3-203C

x = 100 mm
SI-786-3-203D

Ecarteurs
Retractors
Separadores
Divaricatori



Deaver
180 mm – 7"
x = 19 mm
SI-786-3-204



Deaver
215 mm – 8 1/2"
x = 22 mm
SI-786-3-205



Deaver
230 mm – 9"
x = 25 mm
SI-786-3-206

Ecarteurs
Retractors
Separadores
Divaricatori



Deaver
300 mm – 12 "
x = 25 mm
SI-786-3-207

Deaver
330 mm – 13 "
x = 25 mm
SI-786-3-208

Deaver
360 mm – 14 1/4 "
x = 25 mm
SI-786-3-209

Ecarteurs
Retractors
Separadores
Divaricatori



Deaver
300 mm – 12"
x = 38 mm
SI-786-3-210

Deaver
300 mm – 12"
x = 50 mm
SI-786-3-211

Deaver
300 mm – 12"
x = 75 mm
SI-786-3-212

Ecarteurs
Retractors
Separadores
Divaricatori



Roux
Set
SI-786-3-213

Fig. 1
140 mm – 5 1/2 "
24 mm x 20 mm
30 mm x 28 mm
SI-786-3-213A

Fig. 2
150 mm – 6 "
29 mm x 26 mm
36 mm x 36 mm
SI-786-3-213B

Fig. 3
170 mm – 6 3/4 "
33 mm x 29 mm
38 mm x 43 mm
SI-786-3-213C



Parker
Set
SI-786-3-214

Fig. 1
135 mm – 5 1/4 "
18 mm x 15 mm

Fig. 2
135 mm – 5 1/4 "
22 mm x 15 mm

Ecarteurs
Retractors
Separadores
Divaricatori



Parker
180 mm – 7"
Set
SI-786-3-215



26 mm x 25 mm

27 mm x 25 mm

Fig. 1



29 mm x 25 mm

27 mm x 25 mm

Fig. 2



Mini-Roux
145 mm – 5 3/4"
8 mm x 6 mm
SI-786-3-216



Baby-Roux
130 mm – 5"
SI-786-3-217



17 mm x 16 mm

18 mm x 22 mm



Mayo-Collin
150 mm – 6"
Set
SI-786-3-218



25 mm x 18 mm

28 mm x 18 mm

Fig. 1



28 mm x 19 mm

32 mm x 19 mm

Fig. 2

WUNDHAKEN - RETRACTORS

Ecarteurs
Retractors
Separadores
Divaricatori



21 mm x 24 mm

25 mm x 24 mm

40 mm x 15 mm

45 mm x 15 mm

Fig. 1

Fig. 2

Parker-Langenbeck
(US Army)
210 mm – 8 1/4"
Set
SI-786-3-219



42 mm x 13 mm

47 mm x 13 mm

42 mm x 26 mm

46 mm x 26 mm

Fig. 1

Fig. 2

Mathieu
200 mm – 8"
Set
SI-786-3-220

WUNDHAKEN - RETRACTORS

Ecarteurs autostatiques
Self-retaining retractors
Separadores autoestáticos
Divaricatori autostatici



Alm
70 mm – 2 3/4 "
100 mm – 4 "
SI-786-3-231
Sharp
SI-786-3-231A
Semi Sharp
SI-786-3-231B
Blunt



Jansen
100 mm – 4 "
SI-786-3-232
Sharp
SI-786-3-232A
Blunt



Cloward-Contour
140 mm – 5 1/2 "
SI-786-3-233
Sharp 3x4
SI-786-3-233A
Blunt 3x4



Wullstein
100 mm – 4 "
SI-786-3-234
Sharp 3x3
SI-786-3-234A
Blunt 3x3



Weitlaner-Wullstein
130 mm – 5 "
SI-786-3-235
Sharp 3x3
SI-786-3-235A
Blunt 3x3



Milligan
130 mm – 5 "
SI-786-3-236
Blunt 3x3

WUNDHAKEN - RETRACTORS

Ecarteurs autostatiques
Self-retaining retractors
Separadores autoestáticos
Divaricatori autostatici



Belucci
110 mm – 4 1/4 "
130 mm – 5 "
SI-786-3-237
Right, Blunt 1x2



Belucci
110 mm – 4 1/4 "
130 mm – 5 "
SI-786-3-238
Left, Blunt 1x2



Mollison
150 mm – 6 "
SI-786-3-239
Sharp 4x4



Plester
130 mm – 5 "
SI-786-3-240
Sharp 2x2
SI-786-3-240A
blunt 2x2



Plester
110 mm – 4 1/4 "
SI-786-3-241
Left, Blunt 2x1



Plester
110 mm – 4 1/4 "
SI-786-3-242
Right, Blunt 2x1

WUNDHAKEN - RETRACTORS

Ecarteurs autostatiques
Self-retaining retractors
Separadores autoestáticos
Divaricatori autostatici

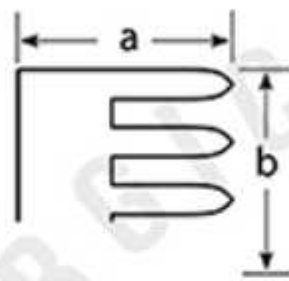

Weitlaner-Loktite
105 mm – 4 1/4 "
a = 17 mm – b = 13 mm
SI-786-3-243
Sharp 2 x 3
SI-786-3-243A
Semi Sharp 2 x 3
SI-786-3-243B
Blunt 2 x 3

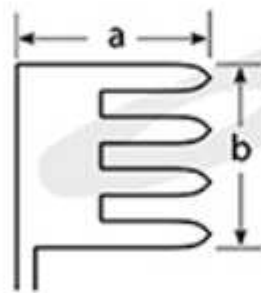

Weitlaner-Loktite
130 mm – 5 "
165 mm – 6 1/2 "
200 mm – 8 "
260 mm – 10 1/4 "

a = 17 mm – b = 17 mm
a = 17 mm – b = 17 mm
a = 20 mm – b = 19 mm
a = 26 mm – b = 21 mm

SI-786-3-244
SI-786-3-244C
SI-786-3-244F
SI-786-3-244I

3 x 4
Sharp

SI-786-3-244A
SI-786-3-244D
SI-786-3-244G
SI-786-3-244J

3 x 4
Semi Sharp

SI-786-3-244B
SI-786-3-244E
SI-786-3-244H
SI-786-3-244K

3 x 4
Blunt

WUNDHAKEN – RETRACTORS

Ecarteurs autostatiques
Self-retaining retractors
Separadores autoestáticos
Divaricatori autostatici



Norfolk and Norwich
220 mm – 8 3/4 "
SI-786-3-245
Blunt 4 x 5



Traves
215 mm – 8 1/2 "
SI-786-3-246
Blunt 4 x 5

WUNDHAKEN – RETRACTORS

Ecarteurs autostatiques
Self-retaining retractors
Separadores autoestáticos
Divaricatori autostatici



Anderson-Adson
195 mm – 7 3/4 "
SI-786-3-247
Sharp 4 x 4
SI-786-3-247A
Blunt 4 x 4



Mayo-Adams
165 mm – 6 1/2 "
SI-786-3-248
Blunt 2 x 2

WUNDHAKEN - RETRACTORS

Ecarteurs autostatiques
Self-retaining retractors
Separadores autoestáticos
Divaricatori autostatici

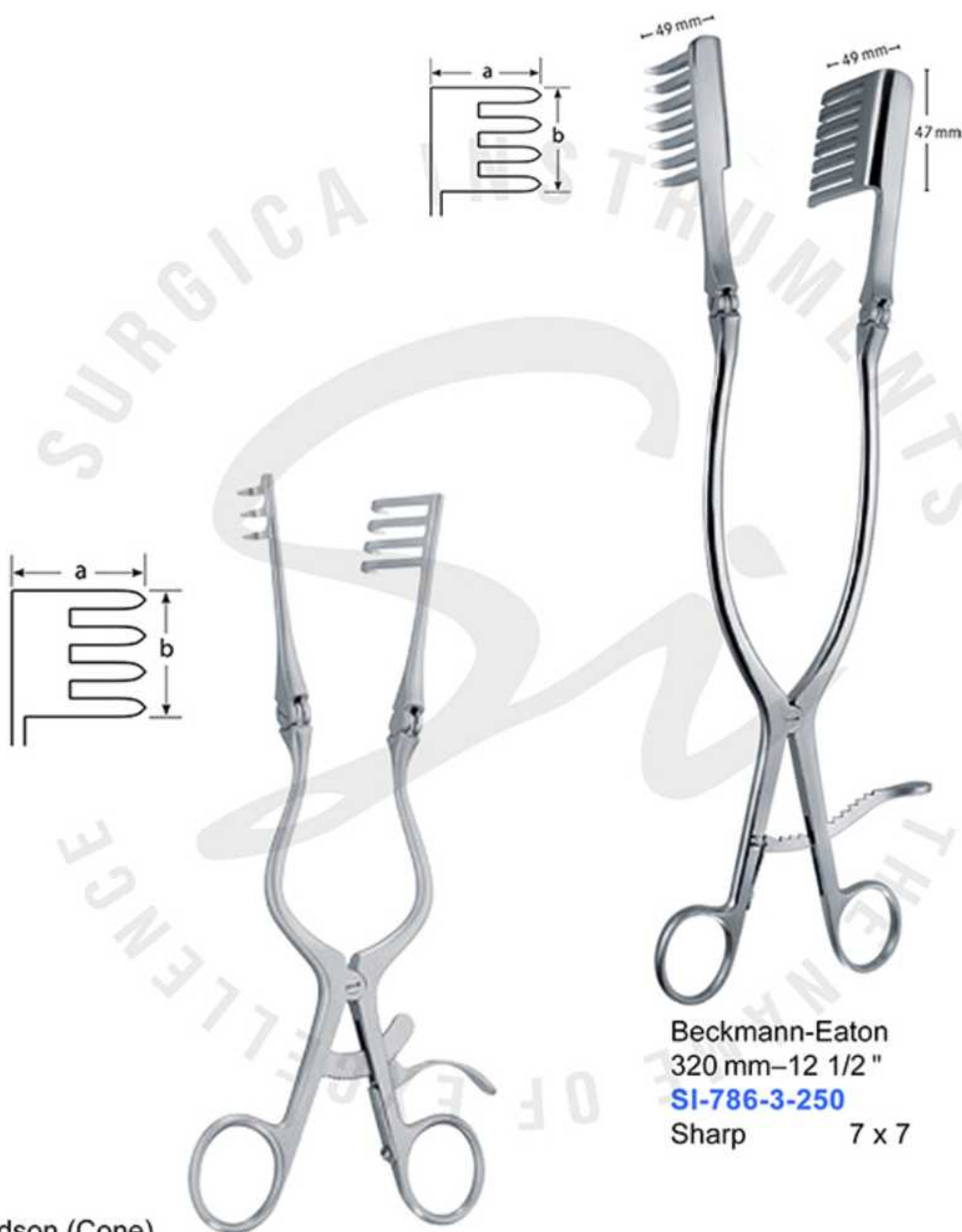

Adson (Cone)

130 mm – 5"

160 mm – 6 1/4"

200 mm – 8"

260 mm – 10 1/4"

a = 17 mm – b = 19 mm

a = 17 mm – b = 19 mm

a = 20 mm – b = 20 mm

a = 26 mm – b = 21 mm

SI-786-3-249

SI-786-3-249B

SI-786-3-249D

SI-786-3-249F

3 x 4

Sharp

SI-786-3-249A

SI-786-3-249C

SI-786-3-249E

SI-786-3-249G

3 x 4

Blunt

Beckmann-Eaton

320 mm – 12 1/2"

SI-786-3-250

Sharp

7 x 7

WUNDHAKEN - RETRACTORS

Ecarteurs autostatiques
Self-retaining retractors
Separadores autoestáticos
Divaricatori autostatici



Beckmann
310 mm – 12 1/4"
SI-786-3-251
Sharp 4 x 4
SI-786-3-251A
Semi Sharp 4 x 4
SI-786-3-251B
Blunt 4 x 4

Adson
3x4 a = 24 mm – b = 24 mm
6x6 a = 40 mm – b = 40 mm

265 mm – 10 1/2"
SI-786-3-252
SI-786-3-252B
Sharp

265 mm – 10 1/2"
SI-786-3-252A
SI-786-3-252C
Blunt

WUNDHAKEN - RETRACTORS

Ecarteurs autostatiques
Self-retaining retractors
Separadores autoestáticos
Divaricatori autostatici



Beckmann-Adson
310 mm - 12 1/4 "

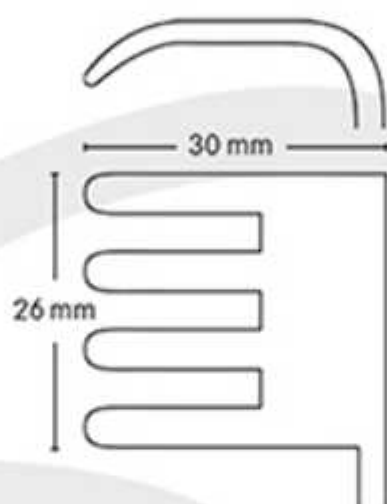

Blunt
SI-786-3-253

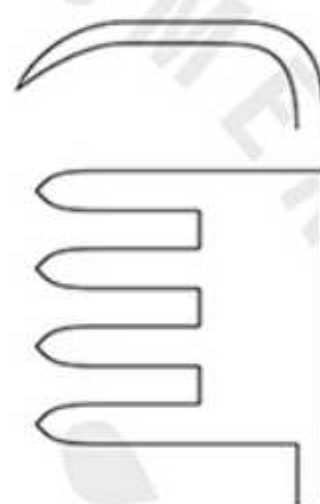

Sharp
SI-786-3-253A

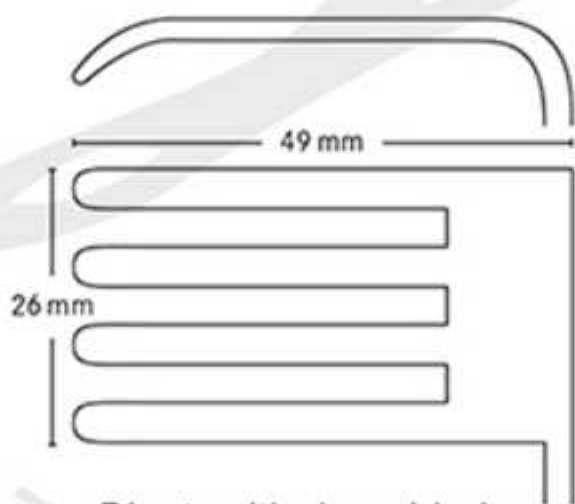

Blunt, with deep blades
SI-786-3-253B



Sharp, with deep blades
SI-786-3-253C

WUNDHAKEN – RETRACTORS

Ecarteurs autostatiques
Self-retaining retractors
Separadores autoestáticos
Divaricatori autostatici



Gelpi-Loktite
90 mm – 3 1/2 "
110 mm – 4 1/4 "
130 mm – 5 "
180 mm – 7 "

SI-786-3-254
SI-786-3-254A
SI-786-3-254B
SI-786-3-254C



Gelpi-Loktite
180 mm – 7 "
SI-786-3-255

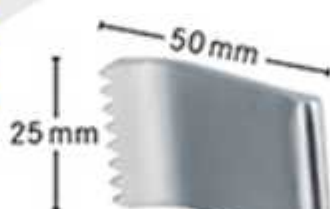

Markham-Meyerding
180 mm – 7 "

SI-786-3-256
Right

SI-786-3-256A
Left

WUNDHAKEN - RETRACTORS

Ecarteurs autostatiques
Self-retaining retractors
Separadores autoestáticos
Divaricatori autostatici



Rigby
180 mm – 7"
SI-786-3-257



Henley
165 mm – 6 1/2"
SI-786-3-258 SI-786-3-258A
3 x 4 3 x 4
Sharp Blunt
Complete with 3 center blades



19 mm x 16 mm
SI-786-3-258B
Center blades



25 mm x 16 mm
SI-786-3-258C



32 mm x 16 mm
SI-786-3-258D

WUNDHAKEN - RETRACTORS

Ecarteurs abdominaux
Separadores abdominales
Abdominal retractors
Divaricatori addominali



Baby-Collin

180 mm – 7 "

x = 80 mm

SI-786-3-259 40 mm x 18 mm

40 mm x 27 mm

Complete with 2 pairs of blades



Collin

220 mm – 8 3/4 "

x = 100 mm

SI-786-3-260

WUNDHAKEN - RETRACTORS

Ecarteurs abdominaux
Separadores abdominales
Abdominal retractors
Divaricatori addominali



Collin
225 mm – 8 3/4 "
x = 100 mm
SI-786-3-261
SI-786-3-261A
SI-786-3-261B
Complete with

a = 38 mm – b = 60 mm
a = 38 mm – b = 80 mm
a = 37 mm – b = 98 mm
Lateral blades

a = 38 mm – b = 55 mm
a = 50 mm – b = 75 mm
a = 53 mm – b = 76 mm
Center blade

WUNDHAKEN - RETRACTORS

Ecarteurs abdominaux
Separadores abdominales
Abdominal retractors
Divaricatori addominali



Collin
260 mm – 10 1/4"
x = 150 mm
SI-786-3-262
Complete with

60 mm x 80 mm
Lateral blades

60 mm x 75 mm
Center blade

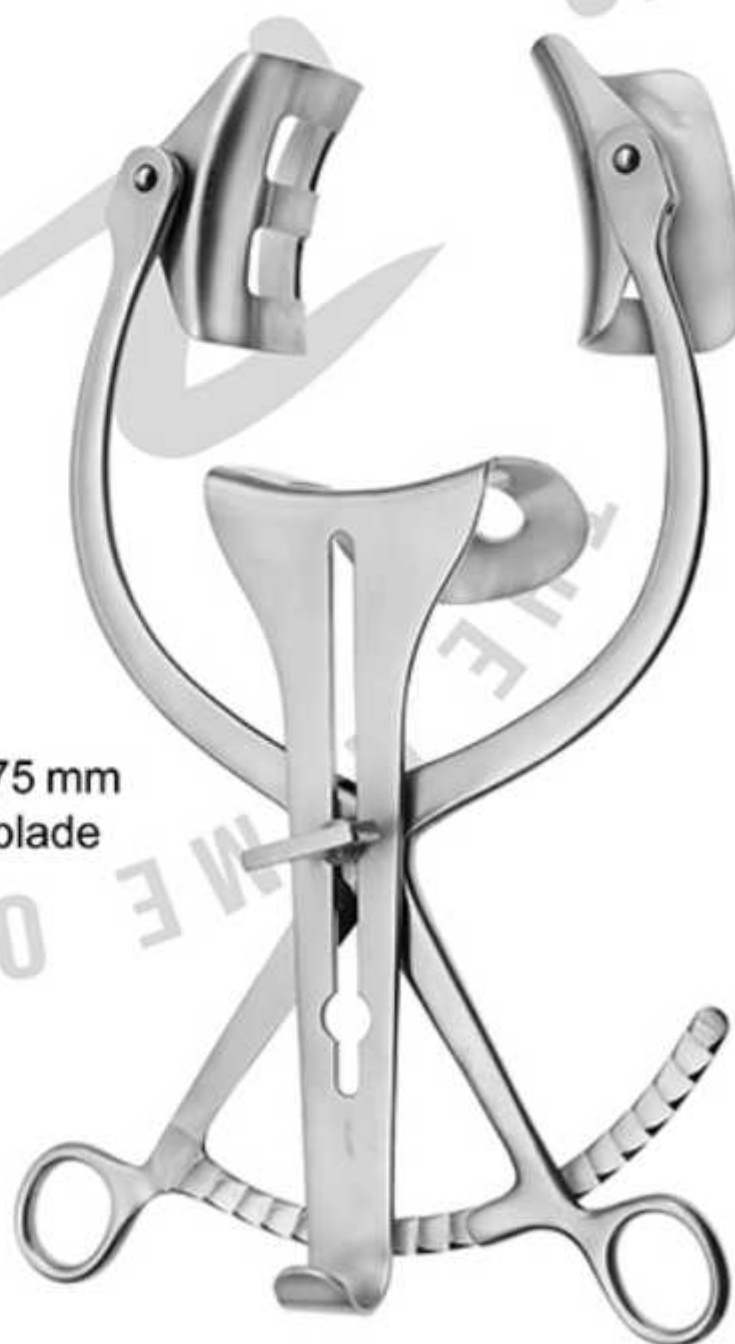

Holzbach
260 mm – 10 1/4"
x = 100 mm
SI-786-3-263
Complete with

62 mm x 80 mm
Lateral blades

80 mm x 80 mm
Center blade

WUNDHAKEN - RETRACTORS

Ecarteurs abdominaux
Separadores abdominales
Abdominal retractors
Divaricatori addominali

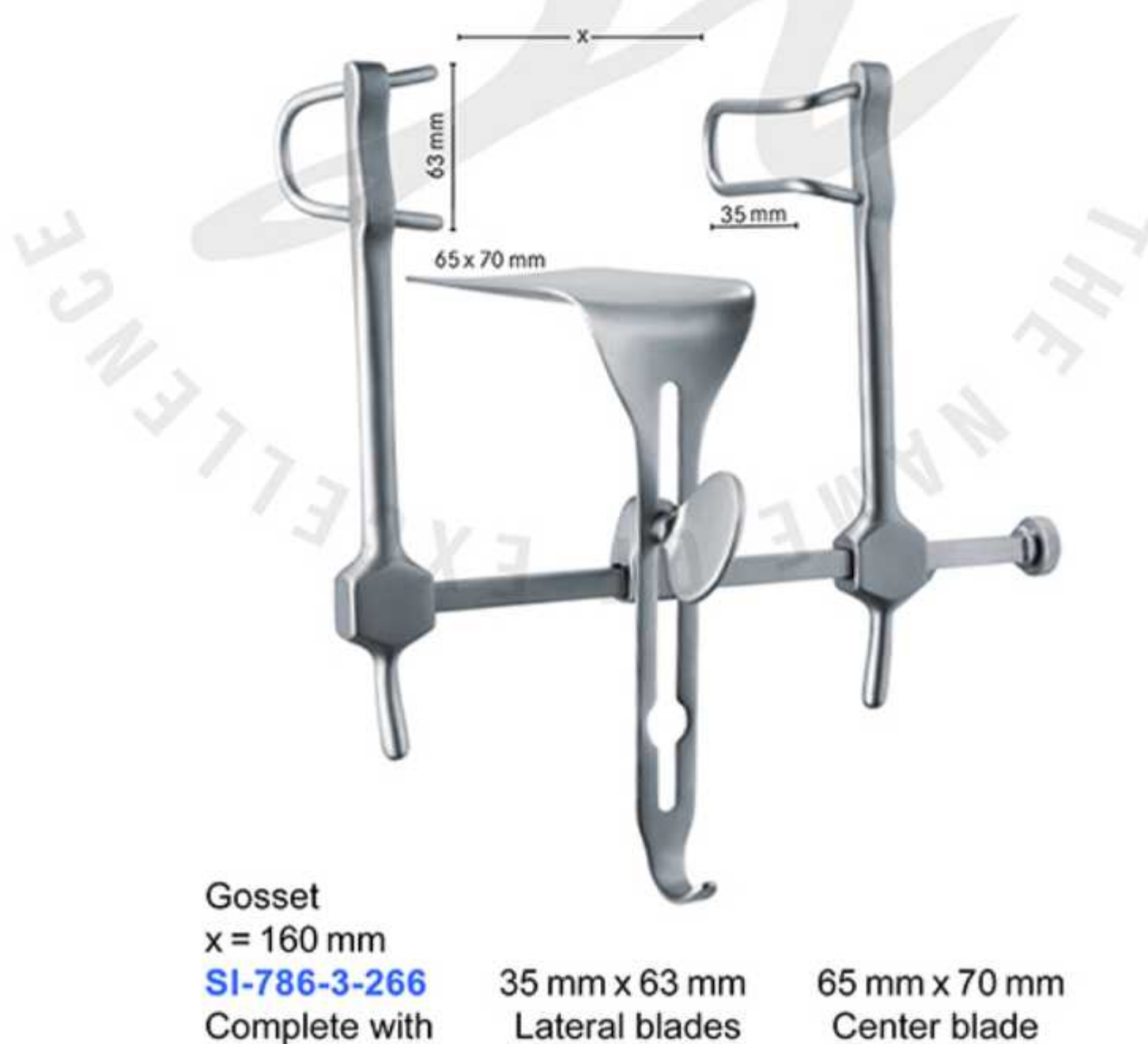
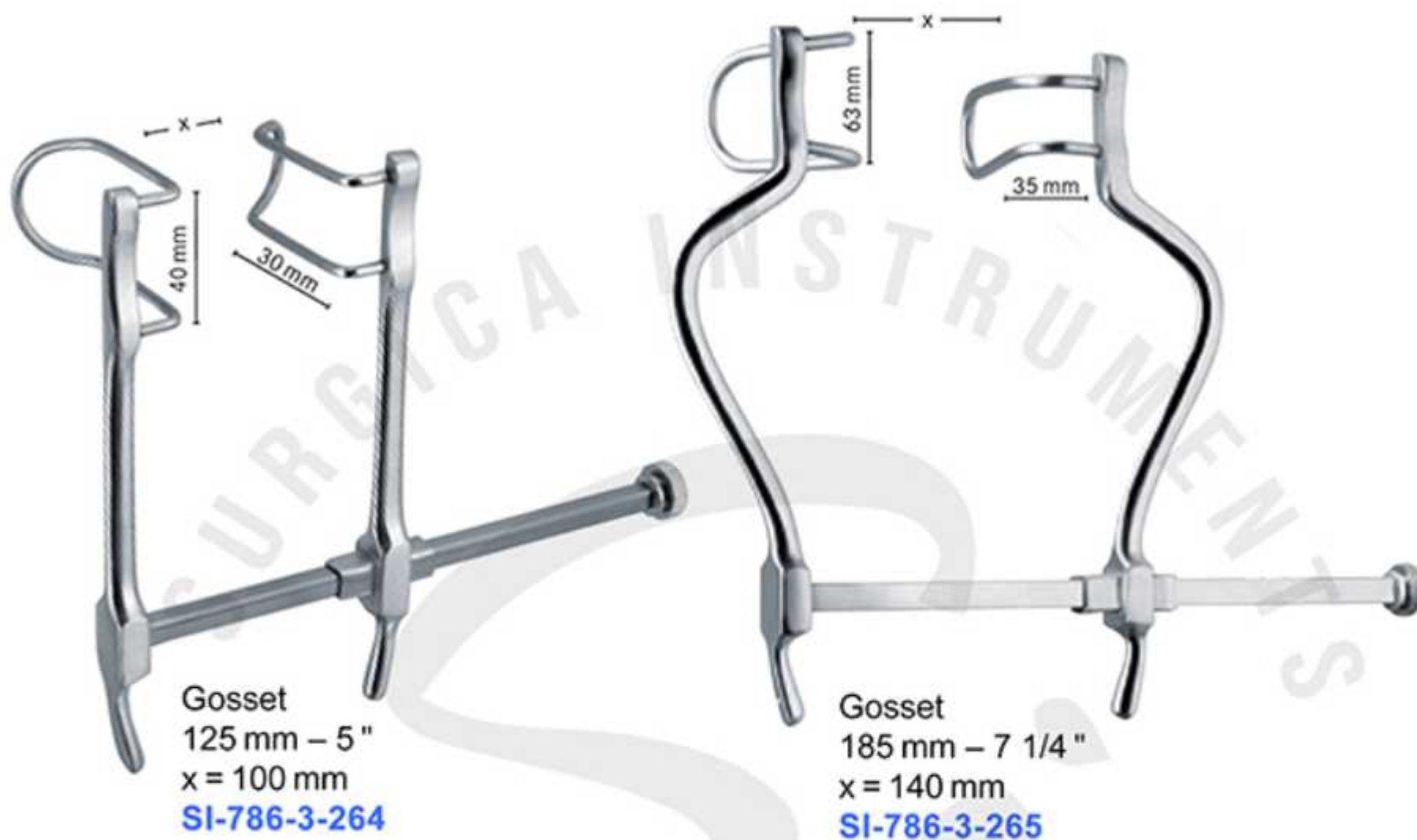

WUNDHAKEN - RETRACTORS

Ecarteurs abdominaux
Separadores abdominales
Abdominal retractors
Divaricatori addominali



Balfour
x = 200 mm
SI-786-3-267
Complete with

35 mm x 100 mm
Lateral blades

70 mm x 100 mm
Center blade



Balfour-Baby
x = 90 mm
SI-786-3-268
Complete with

27 mm x 27 mm
Lateral blades

20 mm x 24 mm
Center blade

WUNDHAKEN - RETRACTORS

Ecarteurs abdominaux
Separadores abdominales
Abdominal retractors
Divaricatori addominali



WUNDHAKEN - RETRACTORS

Ecarteurs abdominaux
Separadores abdominales
Abdominal retractors
Divaricatori addominali



Balfour US
x = 180 mm

SI-786-3-270

60 mm

70 mm x 85 mm

80 mm

Complete with 2 pairs of blades

Center blade

60 mm

SI-786-3-270A

80 mm

SI-786-3-270B

Lateral blades,

70 mm x 85 mm

SI-786-3-270C

Center blades, only



55 mm x 70 mm

Ricard

SI-786-3-271

Complete with

60 mm x 80 mm

Lateral blades

55 mm x 70 mm

Center blade

Ricard

SI-786-3-271A

Complete with

70 mm x 85 mm

Lateral blades

80 mm x 90 mm

Center blade

WUNDHAKEN - RETRACTORS

Ecarteurs abdominaux
Separadores abdominales
Abdominal retractors
Divaricatori addominali



O'Sullivan-O'Connor
SI-786-3-272
Complete with

45 mm x 90 mm
Lateral blades

70 mm x 100 mm
Center blades

80 mm x 90 mm



50 mm x 65 mm

50 mm x 65 mm

50 mm x 98 mm

35 mm x 105 mm

Kirschner, oval
240 mm x 300 mm
SI-786-3-273
1 Frame

50 mm x 65 mm
50 mm x 65 mm
SI-786-3-273A
3 Blades

80 mm x 90 mm
SI-786-3-273B
1 Blade

50 mm x 98 mm
SI-786-3-273C
1 Blade

35 mm x 105 mm
SI-786-3-273D
1 Blade

WUNDHAKEN - RETRACTORS

Ecarteurs abdominaux
Separadores abdominales
Abdominal retractors
Divaricatori addominali

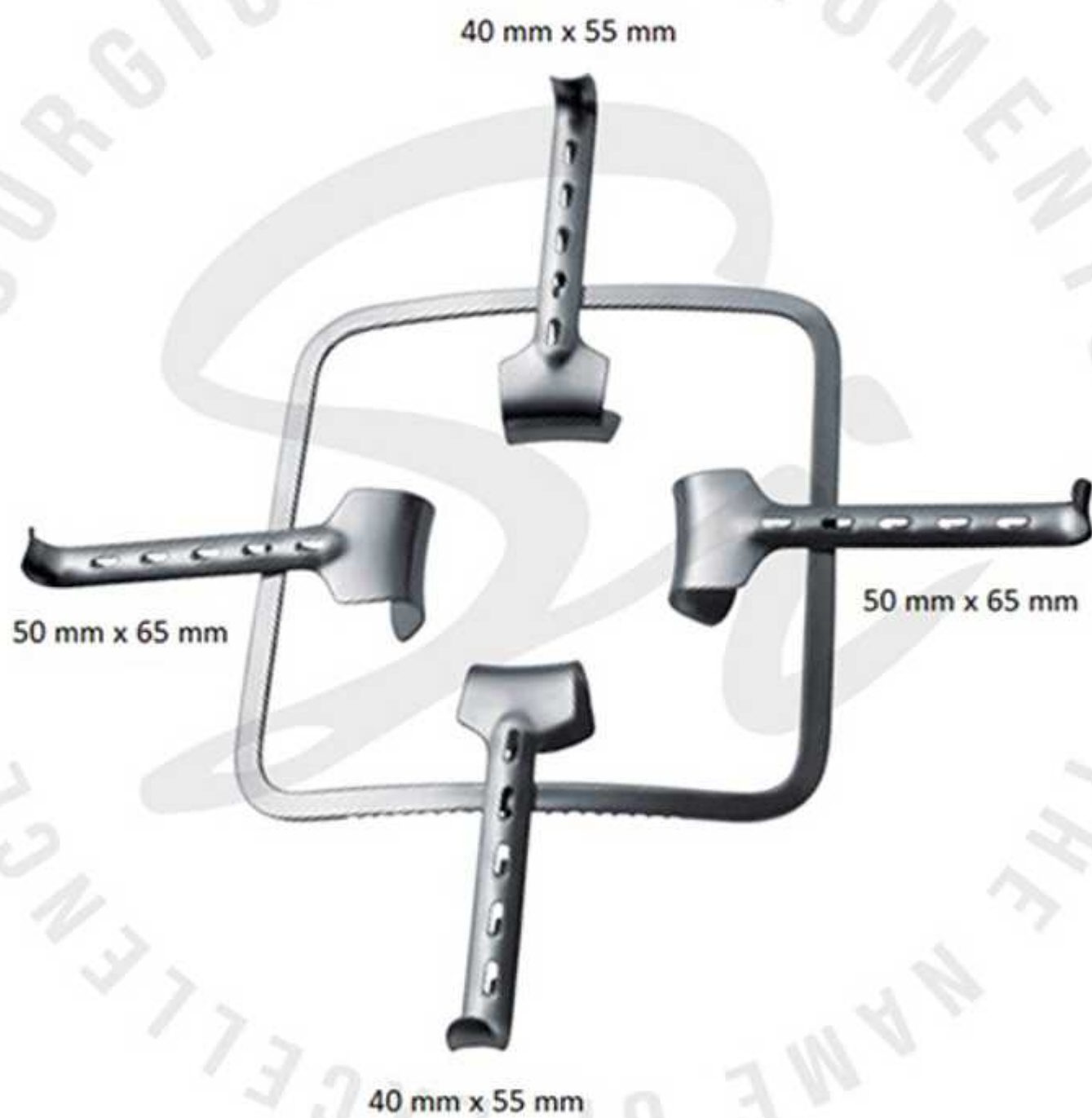

Kirschner
240 mm x 240 mm
SI-786-3-274
1 Frame, rigid

40 mm x 55 mm
SI-786-3-274A
2 Blades

50 mm x 65 mm
SI-786-3-274B
2 Blades

WUNDHAKEN - RETRACTORS

Ecarteurs abdominaux
Separadores abdominales
Abdominal retractors
Divaricatori addominali



Franz

300 mm x 300 mm

SI-786-3-275

1 Frame, foldable

40 mm x 60 mm

SI-786-3-275A

2 Blades

45 mm x 80 mm

SI-786-3-275B

2 Blades

50 mm x 65 mm

SI-786-3-275C

2 Blades

60 mm x 85 mm

SI-786-3-275D

2 Blades

WUNDHAKEN – RETRACTORS

Ecarteurs abdominaux
Separadores abdominales
Abdominal retractors
Divaricatori addominali



Rochard
SI-786-3-284
Fixing frame, one sided

Rochard
SI-786-3-284B
Fixing frame, double sided

Rochard
SI-786-3-284A
Fixing frame, double sided

Blade Sizes

50 x 95 mm	SI-786-3-284C
50 x 105 mm	SI-786-3-284D
60 x 120 mm	SI-786-3-284E
60 x 135 mm	SI-786-3-284F
60 x 155 mm	SI-786-3-284G

WUNDHAKEN - RETRACTORS

Ecarteurs abdominaux
Separadores abdominales
Abdominal retractors
Divaricatori addominali



O'Sullivan-O'Connor
Fig. 1
45 mm x 17 mm
SI-786-3-285



Fig. 2
90 mm x 37 mm
SI-786-3-285A

Fig. 3
90 mm x 45 mm
SI-786-3-285B



Friedmann
100 mm – 4"
SI-786-3-286



Percy
SI-786-BR-287
Handles detachable, simple pattern

Ecarteurs pour laminectomie
Laminectomy retractors
Separadores para laminectomia
Divaricatori per laminectomia



Blunt Blade

- Fig. 1 x = 60 mm [SI-786-4-291A](#)
- Fig. 2 x = 55 mm [SI-786-4-291B](#)
- Fig. 3 x = 50 mm [SI-786-4-291C](#)
- Fig. 4 x = 45 mm [SI-786-4-291D](#)
- Fig. 5 x = 40 mm [SI-786-4-291E](#)

Cloward

160 mm – 6 1/4 "

[SI-786-4-291](#)

Complete with 2 Blades ea. Fig. 1 - Fig. 5



Toothed Blade

- Fig. 1 x = 60 mm [SI-786-4-292A](#)
- Fig. 2 x = 55 mm [SI-786-4-292B](#)
- Fig. 3 x = 50 mm [SI-786-4-292C](#)
- Fig. 4 x = 45 mm [SI-786-4-292D](#)
- Fig. 5 x = 40 mm [SI-786-4-292E](#)

Cloward

250 mm – 9 3/4 "

[SI-786-4-292](#)

Complete with 2 Blades ea. Fig. 1 - Fig. 5

WUNDHAKEN – RETRACTORS

Ecarteurs pour laminectomie
Laminectomy retractors
Separadores para laminectomia
Divaricatori per laminectomia



Inge
165 mm – 6 1/2 "
SI-786-4-293



Inge
270 mm – 10 3/4 "
SI-786-4-294



Cloward-Vertebra
160 mm – 6 1/4 "
SI-786-4-295

WUNDHAKEN - RETRACTORS

Ecarteurs pour laminectomie
Laminectomy retractors
Separadores para laminectomia
Divaricatori per laminectomia

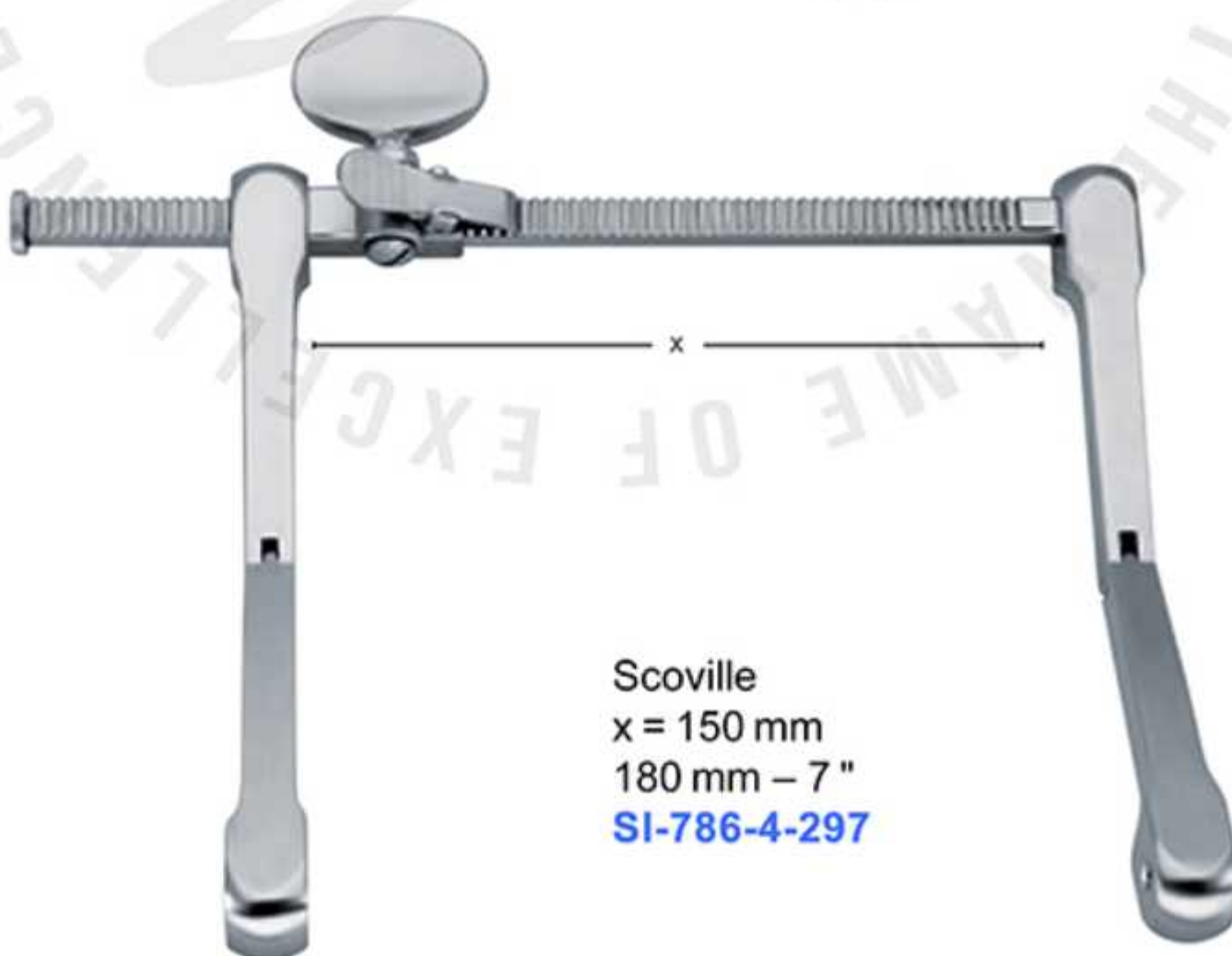
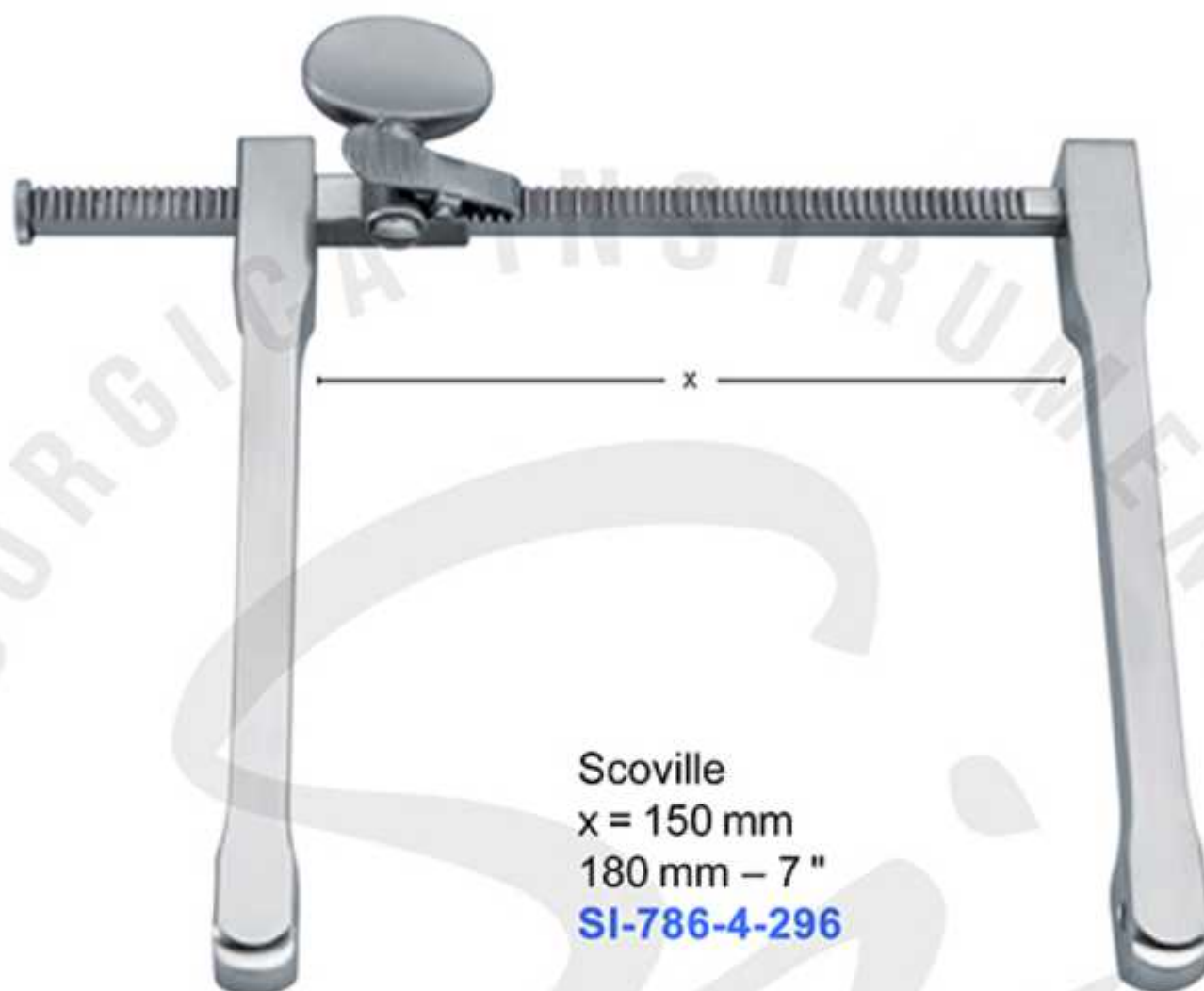

WUNDHAKEN - RETRACTORS

Ecarteurs pour laminectomie
Laminectomy retractors
Separadores para laminectomia
Divaricatori per laminectomia

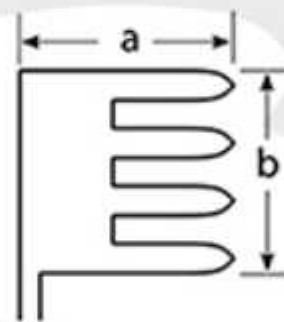

Taylor

a = 48 mm – b = 50 mm – 2" x 2" **SI-786-4-299**
a = 63 mm – b = 50 mm – 2 1/2" x 2" **SI-786-4-299A**
a = 64 mm – b = 64 mm – 3 1/4" x 2 1/4" **SI-786-4-299B**

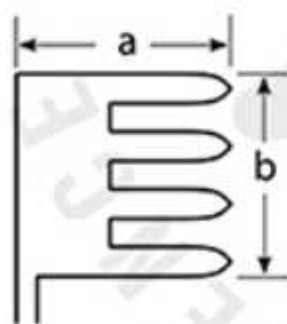

Scoville

a = 40 mm – b = 37 mm – 1 1/2" x 1 1/2" **SI-786-4-300**
a = 65 mm – b = 44 mm – 2 1/2" x 1 3/4" **SI-786-4-300A**

Taylor

a = 100 mm – b = 42 mm – 4" x 1 6/8" **SI-786-4-301**

WUNDHAKEN - RETRACTORS

Ecarteurs pour laminectomie
Laminectomy retractors
Separadores para laminectomia
Divaricatori per laminectomia



Meyerding

- a = 57 mm – b = 25 mm – 2 1/4 " x 1 " **SI-786-4-302**
- a = 76 mm – b = 25 mm – 3 " x 1 " **SI-786-4-302A**
- a = 88 mm – b = 51 mm – 3 1/2 " x 2 " **SI-786-4-302B**



Epstein

- a = 56 mm – b = 25 mm – 2 1/4 " x 1 " **SI-786-4-304**



Hibbs

- a = 50 mm – b = 20 mm – 2 " x 3/4 " **SI-786-4-305**
- a = 50 mm – b = 25 mm – 2 " x 1 " **SI-786-4-305A**
- a = 50 mm – b = 50 mm – 2 " x 2 " **SI-786-4-305B**
- a = 63 mm – b = 25 mm – 2 1/2 " x 1 " **SI-786-4-305C**
- a = 63 mm – b = 37 mm – 2 1/2 " x 1 1/2 " **SI-786-4-305D**
- a = 76 mm – b = 25 mm – 3 " x 1 " **SI-786-4-305E**
- a = 76 mm – b = 38 mm – 3 " x 1 1/2 " **SI-786-4-305F**
- a = 76 mm – b = 50 mm – 3 " x 2 " **SI-786-4-305G**
- a = 76 mm – b = 63 mm – 3 " x 2 1/2 " **SI-786-4-305H**
- a = 90 mm – b = 25 mm – 3 1/2 " x 1 " **SI-786-4-305I**
- a = 90 mm – b = 37 mm – 3 1/2 " x 1 1/2 " **SI-786-4-305J**
- a = 102 mm – b = 25 mm – 4 " x 1 " **SI-786-4-305K**
- a = 102 mm – b = 50 mm – 4 " x 2 " **SI-786-4-305L**

Scoville

- a = 57 mm – b = 25 mm – 2 1/4 " x 1 " **SI-786-4-303**
- a = 57 mm – b = 38 mm – 2 1/4 " x 1 1/2 " **SI-786-4-303A**
- a = 64 mm – b = 50 mm – 2 1/2 " x 2 " **SI-786-4-303B**
- a = 75 mm – b = 25 mm – 3 " x 1 " **SI-786-4-303C**



WUNDHAKEN - RETRACTORS

Ecarteurs pour laminectomie
Laminectomy retractors
Separadores para laminectomia
Divaricatori per laminectomia



Caspar
SI-786-4-306
Complete with 5 medial blades

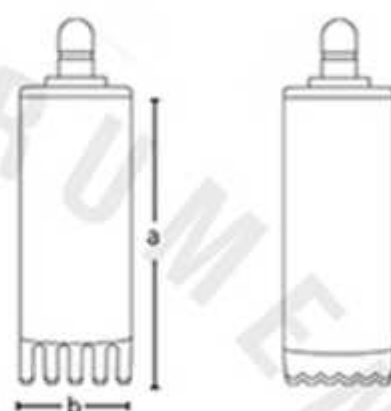

Medial

Lateral

SI-786-4-306A

SI-786-4-306F

SI-786-4-306B

SI-786-4-306G

SI-786-4-306C

SI-786-4-306H

SI-786-4-306D

SI-786-4-306I

SI-786-4-306E

SI-786-4-306J

a = 40 mm – b = 23 mm

a = 45 mm – b = 23 mm

a = 50 mm – b = 23 mm

a = 55 mm – b = 23 mm

a = 60 mm – b = 23 mm



Caspar
SI-786-4-307
Complete with 5 blades



Blunt

a = 45 mm – b = 23 mm **SI-786-4-307**

a = 50 mm – b = 23 mm **SI-786-4-307**

a = 55 mm – b = 23 mm **SI-786-4-307**

a = 60 mm – b = 23 mm **SI-786-4-307**

a = 65 mm – b = 23 mm **SI-786-4-307**

WUNDHAKEN – RETRACTORS

Ecarteurs pour laminectomie
Laminectomy retractors
Separadores para laminectomia
Divaricatori per laminectomia



Caspar
SI-786-4-308

Complete with 6 blades

Blade Options

a = 35 mm – b = 22 mm	SI-786-4-308C
a = 40 mm – b = 22 mm	SI-786-4-308D
a = 45 mm – b = 22 mm	SI-786-4-308E
a = 50 mm – b = 22 mm	SI-786-4-308F
a = 55 mm – b = 22 mm	SI-786-4-308G
a = 60 mm – b = 22 mm	SI-786-4-308H
a = 65 mm – b = 22 mm	SI-786-4-308I
a = 70 mm – b = 22 mm	SI-786-4-308J

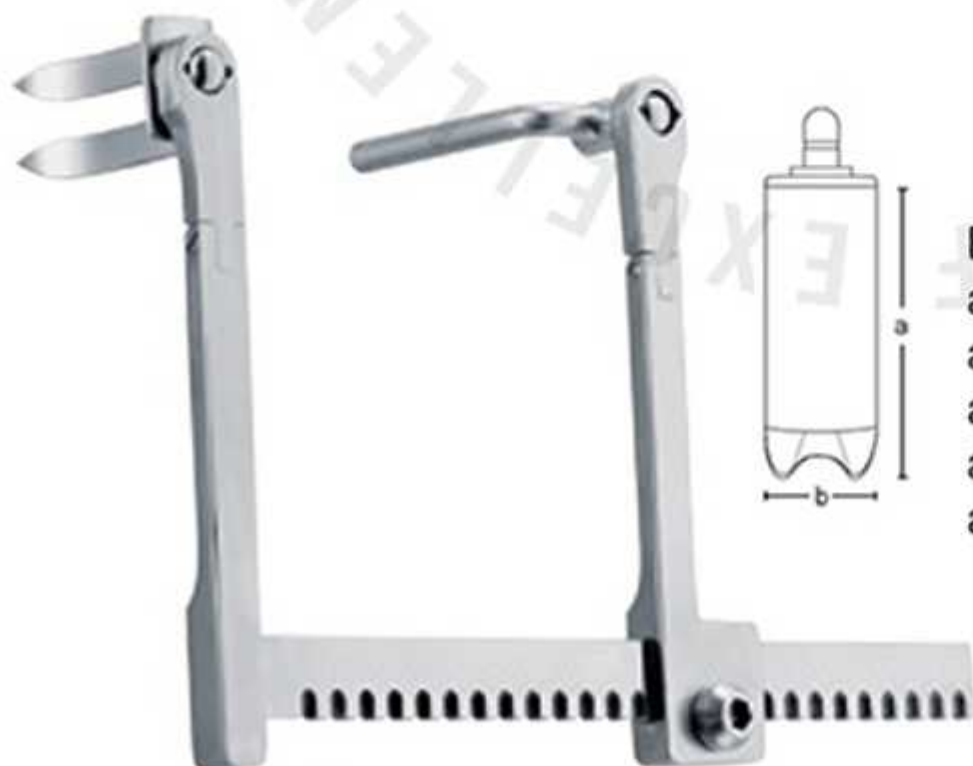

Caspar
SI-786-4-309

Complete with 5 blades

Blade Size

a = 45 mm – b = 23 mm	SI-786-4-309
a = 50 mm – b = 23 mm	SI-786-4-309A
a = 55 mm – b = 23 mm	SI-786-4-309B
a = 60 mm – b = 23 mm	SI-786-4-309C
a = 65 mm – b = 23 mm	SI-786-4-309D

Retracteurs pour la micro discectomie lumbaire
Retractors for Micro-Lumbar Discectomy
Retractor para la micro discectomia lumbar
Divaricatore per la micro dissezione lombare



Speculum for trans-sphenoidal hypophysectomy
x = 70 mm **SI-786-4-316**
x = 90 mm **SI-786-4-316A**
x = 110 mm **SI-786-4-316B**

WUNDHAKEN – RETRACTORS

Spatulas abdominales
Abdominal spatulas
Espátulas abdominales
Spatole addominali



Martin

330 mm – 13 "
Malleable

30 mm

SI-786-4-287

40 mm

SI-786-4-287A

50 mm

SI-786-4-287B



Martin

200 mm – 8 "
12 mm

SI-786-4-288

Soft

200 mm – 8 "
17 mm

SI-786-4-288A

250 mm – 9 3/4 "
25 mm

SI-786-4-288B

200 mm – 8 "
6,5 mm

SI-786-4-288C

9,5 mm

SI-786-4-288D

13 mm

SI-786-4-288E

16 mm

SI-786-4-288F

19 mm

SI-786-4-288G

25 mm

SI-786-4-288H

Malleable, Very Soft

WUNDHAKEN – RETRACTORS

Spatulas abdominales
Abdominal spatulas
Espátulas abdominales
Spatole addominali



Haberer
200 mm – 8 "
17 mm / 25 mm
SI-786-4-289

280 mm – 11 "
25 mm / 30 mm
SI-786-4-289A

300 mm – 12 "
37 mm / 45 mm
SI-786-4-289B



Reverdin
280 mm – 11 "
46 mm x 60 mm
SI-786-4-290

WUNDHAKEN - RETRACTORS

Abdominaux (Kits Bookwalter)
Abdominal (Bookwalter Kits)
Bauch (Bookwalter Kits)
Abdominales (Kits Bookwalter)



Bookwalter Retractor Kit II

SI-786-4-317

Includes Part Numbers and Quantities Listed Below:

DESCRIPTION	LENGTH	QTY
Table Post	12 in 304 mm	1
Post Coupling		1
Horizontal Bar	14 1/4 in 365 mm	1
Horizontal Flex Bar		1
Medium Oval Ring		1
Segmented Ring		1
Ratchet Mechanisms		2
Tilt Ratchet Mechanisms		6
Harrington Retractors		1
Balfour Retractors		1
Kelly Retractors	2 x 3 in 51 x 76 mm	2
Kelly Retractors	2 x 4 in 51 x 102 mm	1
Kelly Retractors	2 x 5 in 51 x 127 mm	1
Kelly Retractors	2 x 6 in 51 x 152 mm	1
Malleable Retractors	1 1/2 x 6 in 38 x 152 mm	1
Malleable Retractors	2 x 6 in 51 x 152 mm	2
Malleable Retractors	3 x 6 in 76 x 152 mm	1
Gelpi Retractor		1
ACCESSORIES		
Table Fixation and Ring Case		1
Blade and Accessories Case		1

WUNDHAKEN - RETRACTORS

Abdominaux (Kits Bookwalter)
Abdominal (Bookwalter Kits)
Bauch (Bookwalter Kits)
Abdominales (Kits Bookwalter)



Bookwalter Small Incision Kit

SI-786-4-318

DESCRIPTION

Includes Part Numbers Listed Below:

Round Ring

Retractor Gelpi Blade

Kelly Retractor Blades

Kelly Blade

LENGTH

QTY

8 1/2 in 216 mm

1

1 x 1 1/2 in 25 x 38 mm

1

1 x 2 1/2 in 25 x 64 mm

1

1

WUNDHAKEN – RETRACTORS

Abdominaux (Kits Bookwalter)
Abdominal (Bookwalter Kits)
Bauch (Bookwalter Kits)
Abdominales (Kits Bookwalter)



Bookwalter Obese Patient Retractor System, 18 Inch (458 mm) Table Post

SI-786-4-319

DESCRIPTION

Includes Part Numbers Listed Below:

Table Post Obese Patients

Malleable Blade

Malleable Blade

Malleable Blade

Kelly Blade

Balfour Blade

Harrington Blade

Ratchet Extender

Twister Ratchet

Horizontal Bar

Post Coupling

Retractor, Oval Ring Medium

Kelly Retractor Blades

Kelly Retractor Blades

Tilting Ratchet

DIMENSIONS

			QTY
	18 in	458 mm	1
	2 x 10 in	51 x 254 mm	1
	3 x 10 in	76 x 254 mm	1
	4 x 8 in	102 x 203 mm	1
	2 x 8 in	51 x 203 mm	1
	3 1/2 x 2 3/4 in	89 x 70 mm	1
	3 1/2 x 10 in	89 x 254 mm	1
			1
	14 1/4 in	365 mm	1
	1 x 1 in	25 x 25 mm	1
			1
	2 x 3 in	51 x 76 mm	1
	2 x 4 in	51 x 102 mm	1
			6

WUNDHAKEN - RETRACTORS

Abdominaux (Kits Bookwalter)
Abdominal (Bookwalter Kits)
Bauch (Bookwalter Kits)
Abdominales (Kits Bookwalter)



Bookwalter Obese Patient Accessory Kit, 18 Inch (458 mm) Table Post

SI-786-4-320

DESCRIPTION

Includes Part Numbers Listed Below:

Table Post

Malleable Blade

Malleable Blade

Malleable Blade

Kelly Blade

Balfour Blade

Harrington Blade

Ratchet Extender

Twister Ratchet

DIMENSIONS

QTY

Table Post			1
Malleable Blade	2 x 10 in	51 x 254 mm	1
Malleable Blade	3 x 10 in	76 x 254 mm	1
Malleable Blade	4 x 8 in	102 x 203 mm	1
Kelly Blade	2 x 8 in	51 x 203 mm	1
Balfour Blade	3 1/2 x 2 3/4 in	89 x 70 mm	1
Harrington Blade	3 1/2 x 10 in	89 x 254 mm	1
Ratchet Extender			1
Twister Ratchet			1



Bookwalter Obese Patient Accessory Kit, 24 Inch (610 mm) Table Post

SI-786-4-321

DESCRIPTION

Includes Part Numbers Listed Below:

Table Post

Malleable Blade

Malleable Blade

Malleable Blade

Kelly Blade

Balfour Blade

Harrington Blade

Ratchet Extender

Twister Ratchet

DIMENSIONS

QTY

Table Post	24 in	610 mm	1
Malleable Blade	2 x 10 in	51 x 254 mm	1
Malleable Blade	3 x 10 in	76 x 254 mm	1
Malleable Blade	4 x 8 in	102 x 203 mm	1
Kelly Blade	2 x 8 in	51 x 203 mm	1
Balfour Blade	3 1/2 x 2 3/4 in	89 x 70 mm	1
Harrington Blade	3 1/2 x 10 in	89 x 254 mm	1
Ratchet Extender			1
Twister Ratchet			1

WUNDHAKEN - RETRACTORS

Abdominaux (Kits Bookwalter)
Abdominal (Bookwalter Kits)
Bauch (Bookwalter Kits)
Abdominales (Kits Bookwalter)



Bookwalter Obese Patient Retractor System, 24 Inch (610 mm) Table Post

SI-786-4-322

DESCRIPTION

Includes Part Numbers Listed Below:

Table Post

Malleable Blade

Malleable Blade

Malleable Blade

Kelly Blade

Balfour Blade

Harrington Blade

Ratchet Extender

Twister Ratchet

Horizontal Bar

Post Coupling

Medium Oval Ring

Kelly Blade

Kelly Blade

Tilt Ratchet

LENGTH

QTY

24 in	610 mm	1
2 x 10 in	51 x 254 mm	1
3 x 10 in	76 x 254 mm	1
4 x 8 in	102 x 203 mm	1
2 x 8 in	51 x 203 mm	1
3 1/2 x 2 3/4 in	89 x 70 mm	1
3 1/2 x 10 in	89 x 254 mm	1
		1
14 1/4 in	365 mm	1
1 x 1 in	25 x 25 mm	1
		1
2 x 3 in	51 x 76 mm	1
2 x 4 in	51 x 102 mm	1
		6



Bookwalter Richardson Blade Kit

SI-786-4-323

DESCRIPTION

Includes One of the Following Three Blades:

Blade

Blade

Blade

LENGTH

3/4 x 1 in	19 x 25 mm
3/4 x 2 in	19 x 51 mm
1 x 1 1/4 in	25 x 32 mm

WUNDHAKEN - RETRACTORS

Abdominaux (Barres Bookwalter)
Abdominal (Bookwalter Bars)
Bauch (Bookwalter Bars)
Abdominales (barras Bookwalter)



Bookwalter Violi Gooseneck Table Post
DESCRIPTION
Table Post for 1 in (25 mm) System
[SI-786-4-327](#)



Bookwalter Lightweight Horizontal Bar
DESCRIPTION
Horizontal Bar
LENGTH
14 1/4 in 362 mm
[SI-786-4-328](#)



Bookwalter Lightweight Horizontal Flex Bar
DESCRIPTION
Lightweight Horizontal Flex Bar
[SI-786-4-329](#)

WUNDHAKEN - RETRACTORS

Abdominaux (Barres Bookwalter)
Abdominal (Bookwalter Bars)
Bauch (Bookwalter Bars)
Abdominales (barras Bookwalter)



Bookwalter Ironman Horizontal
DESCRIPTION
Violi Ironman Horizontal Ring Holder
SI-786-4-330



Bookwalter Lightweight Horizontal Bar
DESCRIPTION
Horizontal Bar
LENGTH
15 1/4 in 387 mm
SI-786-4-331



Bookwalter Lightweight Extension Bar
DIMENSIONS
12 in 305 mm
18 in 458 mm
SI-786-4-332



Bookwalter Gelpi Blade
DIMENSIONS
1 x 5 1n 25 x 127 mm
SI-786-4-333

WUNDHAKEN - RETRACTORS

Abdominal (Lames Bookwalter)
Abdominal (Bookwalter Blades)
Bauch (Bookwalter Blades)
Abdominales (Cuchillas Bookwalter)



Bookwalter Balfour Blade

DIMENSIONS

2 3/4 x 3in 70 x 76 mm
3 1/2 x 2 3/4 in 89 x 70 mm

SI-786-4-334



Bookwalter Harrington Blade

DIMENSIONS

2 1/2 x 5 5/8 in 63 x 143 mm
3 1/2 x 10 in 89 x 254 mm

SI-786-4-335

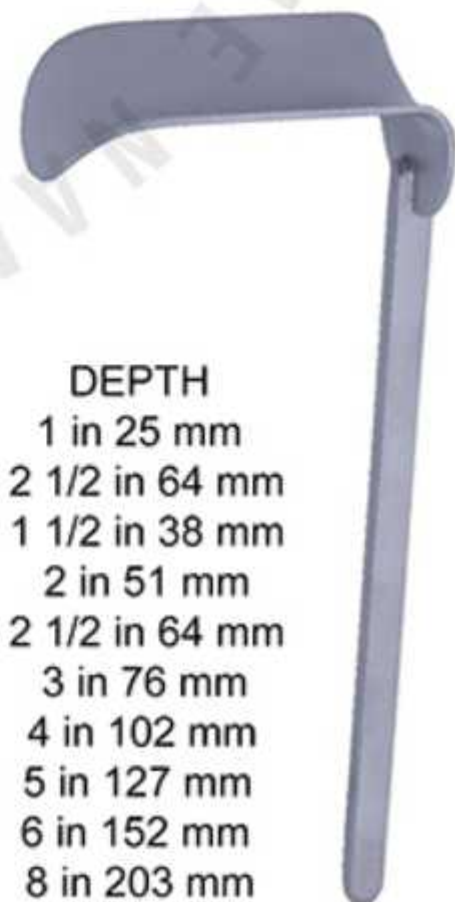

Bookwalter Kelly Blade

CODE

SI-786-4-336
SI-786-4-336A
SI-786-4-336B
SI-786-4-336C
SI-786-4-336D
SI-786-4-336E
SI-786-4-336F
SI-786-4-336G
SI-786-4-336H
SI-786-4-336I

DESCRIPTION

Kelly Blade
Kelly Blade
Kelly Blade
Kelly Blade
Kelly Blade
Kelly Blade
Kelly Blade
Kelly Blade
Kelly Blade
Kelly Blade

WIDTH

1 in 25 mm
1 in 25 mm
2 in 51 mm
2 in 51 mm
2 in 51 mm
2 in 51 mm
2 in 51 mm
2 in 51 mm
2 in 51 mm
2 in 51 mm

DEPTH

1 in 25 mm
2 1/2 in 64 mm
1 1/2 in 38 mm
2 in 51 mm
2 1/2 in 64 mm
3 in 76 mm
4 in 102 mm
5 in 127 mm
6 in 152 mm
8 in 203 mm

WUNDHAKEN – RETRACTORS

Abdominal (Lames Bookwalter)
Abdominal (Bookwalter Blades)
Bauch (Bookwalter Blades)
Abdominales (Cuchillas Bookwalter)



Bookwalter Opti-Length Retractor Blade
Malleable with Lip

CODE	DIMENSIONS	
SI-786-4-337	1 1/2 x 11 in	38 x 279 mm
SI-786-4-337A	2 x 11 in	51 x 279 mm
SI-786-4-337B	3 x 11 in	76 x 279 mm
SI-786-4-337C	4 x 11 in	102 x 279 mm



Bookwalter Rake Retractor

CODE	DESCRIPTION	WIDTH	DEPTH
SI-786-4-338	3 Prong	2/3 in 17 mm	3/4 in 19 mm
SI-786-4-338A	4 Prong	3/4 in 19 mm	1/3 in 8.4 mm
SI-786-4-338B	6 Prong	1 in 25 mm	1/3 in 8.4 mm

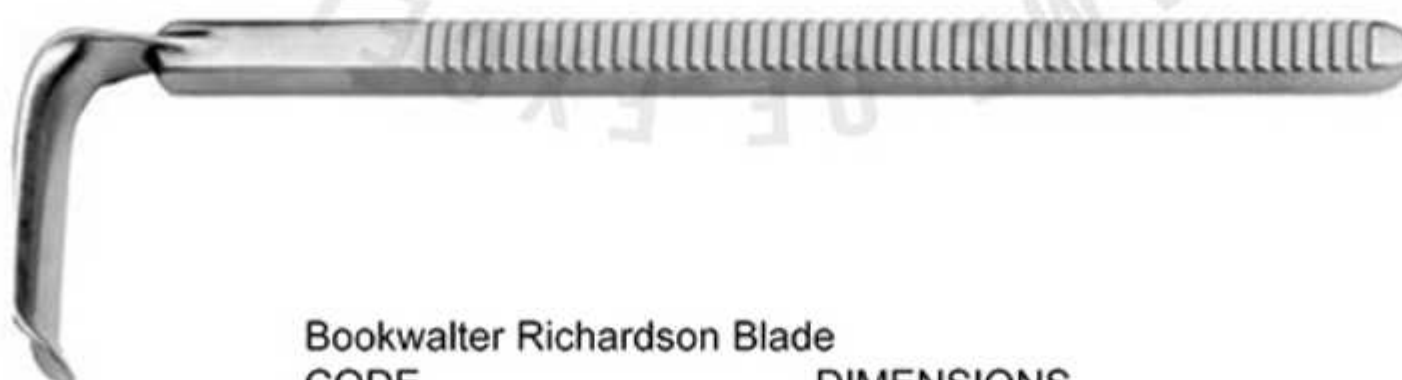

Bookwalter Richardson Blade

CODE	DIMENSIONS	
SI-786-4-339	3/4 x 1 in	19 x 25 mm
SI-786-4-339A	3/4 x 2 in	19 x 51 mm
SI-786-4-339B	1 x 1 1/4 in	25 x 32 mm

WUNDHAKEN - RETRACTORS

Abdominal (Lames Bookwalter)
Abdominal (Bookwalter Blades)
Bauch (Bookwalter Blades)
Abdominales (Cuchillas Bookwalter)

Bookwalter Scoville Hook
DESCRIPTION DIMENSIONS
Small 2 in 51 mm
Large 3 1/4 in 83 mm
SI-786-4-340

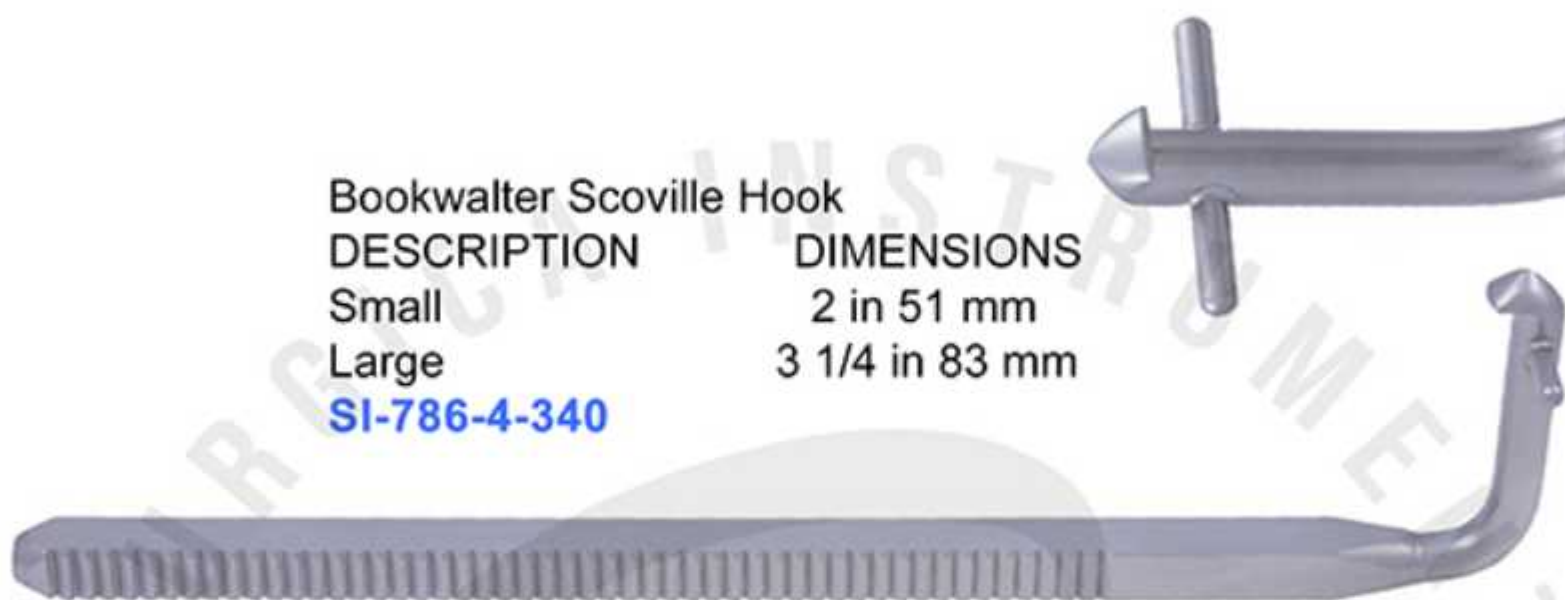

Bookwalter-Meyerding Retractor Blade
DESCRIPTION DIMENSIONS
Small 2/3 x 2 1/3 in 17 x 60 mm
Medium 1 x 3 1/3 in 25 x 85 mm
Large 2 x 3 3/4 in 51 x 95 mm
SI-786-4-341

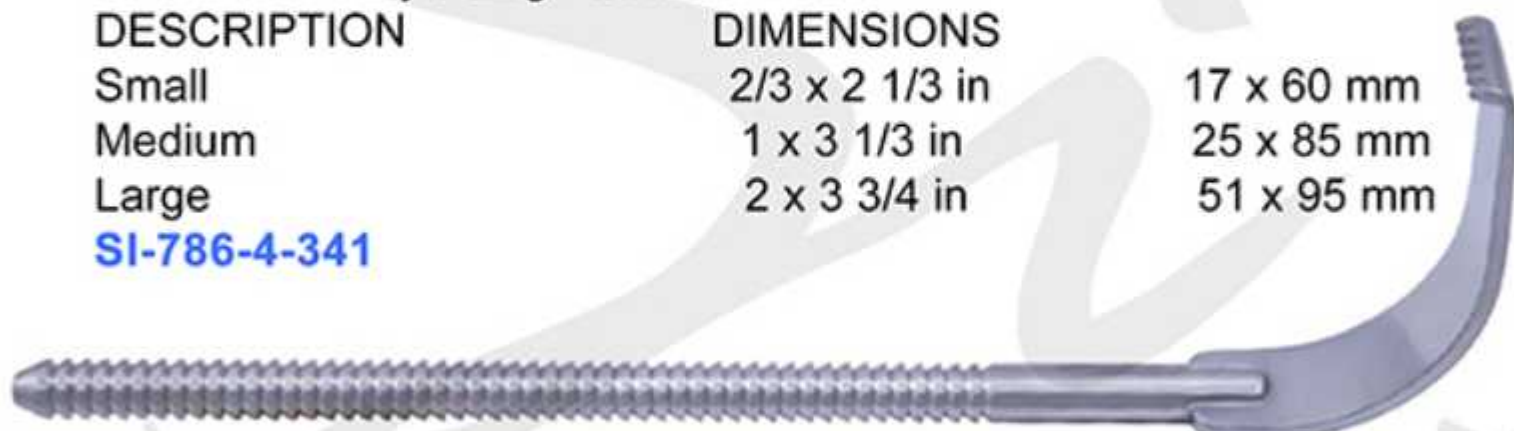

Bookwalter Malleable Retractor Blade
Stainless Steel Matte Finish

CODE	WIDTH	LENGTH
SI-786-4-342	2 x 6 in	51 x 152 mm
SI-786-4-342A	1 1/2 x 6 in	38 x 152 mm
SI-786-4-342B	3 x 6 in	76 x 152 mm
SI-786-4-342C	2 x 10 in	51 x 254 mm
SI-786-4-342D	3 x 10 in	76 x 254 mm
SI-786-4-342E	4 x 8 in	101 x 203 mm



WUNDHAKEN - RETRACTORS

Abdominal (Lames Bookwalter)
Abdominal (Bookwalter Blades)
Bauch (Bookwalter Blades)
Abdominales (Cuchillas Bookwalter)



Bookwalter Retractor Blade

Malleable with Lip

DESCRIPTION

Small

Medium

SI-786-4-343

DIMENSIONS

2 x 6 in 51 x 152 mm

1 1/2 x 6 in 38 x 152 mm



Bookwalter Retractor Blade

Malleable with Lip

DESCRIPTION

Short

Large

SI-786-4-344

DIMENSIONS

1 x 4 in 25 x 102 mm

3 x 6 in 76 x 152 mm



Bookwalter Retractor Blade

Malleable with Lip

DESCRIPTION

Small

Medium

Large

SI-786-4-345

DIMENSIONS

1 1/2 x 6 in 38 x 152 mm

2 x 6 in 51 x 152 mm

3 x 6 in 76 x 152 mm

WUNDHAKEN - RETRACTORS

Abdominal (Lames Bookwalter)
Abdominal (Bookwalter Blades)
Bauch (Bookwalter Blades)
Abdominales (Cuchillas Bookwalter)



Bookwalter-Magrina Retractor Blade

DESCRIPTION

Super Malleable with Lip

SI-786-4-346

DIMENSIONS

1 x 4 in 25 x 102 mm



Bookwalter Radiolucent Titanium Blade

Low Glare Gold Coating

CODE

SI-786-4-347

SI-786-4-347A

SI-786-4-347B

SI-786-4-347C

SI-786-4-347D

SI-786-4-347E

SI-786-4-347F

SI-786-4-347G

SI-786-4-347H

SI-786-4-347I

DESCRIPTION

Titanium Blade

Titanium Blade

Titanium Blade

Titanium Blade

Titanium Blade

Titanium Blade

Titanium Blade

Titanium Blade

Titanium Blade

Titanium Blade

DIMENSIONS

1 x 4 in 25 x 102 mm

1 x 5 in 25 x 127 mm

1 x 6 in 25 x 152 mm

1 x 7 in 25 x 178 mm

1 x 8 in 25 x 203 mm

2 x 4 in 51 x 102 mm

2 x 5 in 51 x 127 mm

2 x 6 in 51 x 152 mm

2 x 7 in 51 x 178 mm

2 x 8 in 51 x 203 mm

Bookwalter Lightweight Post Coupling

DESCRIPTION

For a 1 in (25 mm) System

SI-786-4-348



WUNDHAKEN - RETRACTORS

- Abdominaux (Cliquets Bookwalter)
- Abdominal (Bookwalter Ratchets)
- Bauch (Bookwalter Ratschen)
- Abdominal (trinquetes Bookwalter)



Bookwalter Flat Ratchet
DESCRIPTION
Basic Ratchet Provides Simple retraction at 0° angle .

SI-786-4-350
QTY
1/ Each
Sold Individually



Bookwalter Tilt Ratchet
DESCRIPTION
Tilt Ratchet articulates the blade

SI-786-4-351
QTY
1/ Each
Sold Individually



Bookwalter Rotilt Ratchet
DESCRIPTION
The Rotilt Ratchet twists the blade in 7 indexed positions along a 60° arch and has the ability to idependently articulate the blade .

SI-786-4-352
QTY
1/ Each
Sold Individually

WUNDHAKEN - RETRACTORS

Abdominaux (Cliquets Bookwalter)
Abdominal (Bookwalter Ratchets)
Bauch (Bookwalter Ratschen)
Abdominal (trinquetes Bookwalter)



Bookwalter Self -Retaining Low Profile Locking Rotilt Ratchet

SI-786-4-353

DESCRIPTION

Self -Retaining Low
Profile Locking Rotilt .

QTY

1/ Each

Sold Individually



Bookwalter Self -Retaining Tilt Ratchet

DESCRIPTION

Like the SI- 786-4-354 this Rathet articulates the blade, it also has an additional self -retention latch that holds the Ratchet onto the Bookwalter Retractor Ring.

SI-786-3-354

QTY

1/ Each

Sold Individually

WUNDHAKEN – RETRACTORS

Abdominaux (Cliquets Bookwalter)
Abdominal (Bookwalter Ratchets)
Bauch (Bookwalter Ratschen)
Abdominal (trinquetes Bookwalter)



Bookwalter Self -Retaining Low Profile Locking Rotilt Ratchet

SI-786-4-355

DESCRIPTION

The Bookwalter Self -retaining Low Profile Locking Rotilt Ratchet bring all of the best features of all other ratchets into one mechanism . The low profile design, inclusive of the capacity to tilt,rotate and Self-retention it is the one ratchet to build your Bookwalter set .

QTY
1/ Each
Sold Individually



Bookwalter Twister Ratchet

SI-786-4-356

DESCRIPTION
Twister Ratchet

QTY
1/ Each
Sold Individually



Bookwalter Ratchet Extender **SI-786-4-353**

DESCRIPTION
Ratchet Extender

WUNDHAKEN – RETRACTORS

Abdominaux (Anneaux Bookwalter)
Abdominal (Bookwalter Rings)
Bauch (Bookwalter Ringe)
Abdominales (Anillos Bookwalter)



Bookwalter Segmented Elliptical Ring

CODE	DESCRIPTION	DIMENSIONS	
SI-786-4-358	Elliptical Ring	14 1/2 x 15 in	368 x 380 mm



Bookwalter Oval Ring

CODE	DESCRIPTION	DIMENSIONS	
SI-786-4-359	Small	8 x 12 1/4 in	203 x 311 mm
SI-786-4-359A	Medium	10 1/2 x 14 1/2 in	267 x 368 mm
SI-786-4-359B	Large	12 x 18 1/2 in	305 x 470 mm

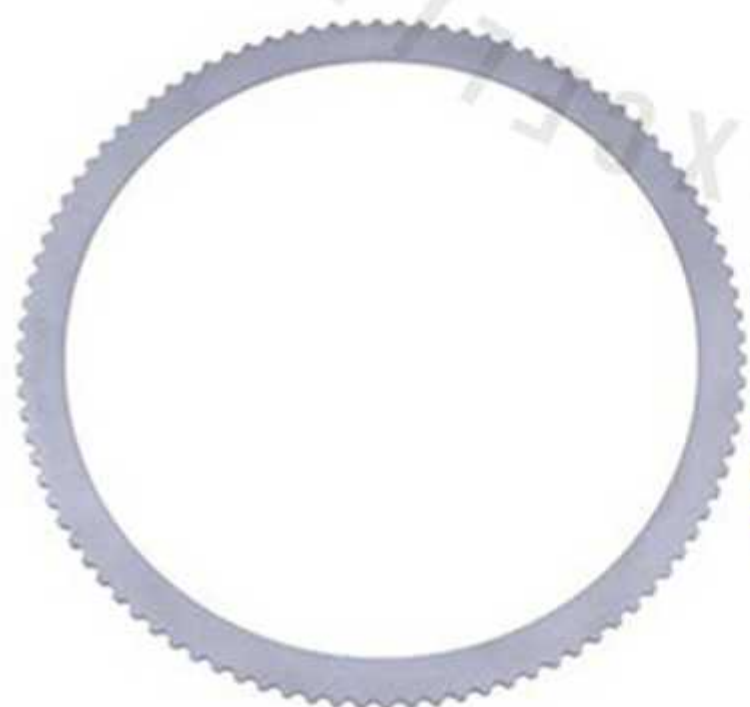

Bookwalter Round Ring
Table Mounted

CODE	DESCRIPTION	DIAMETER	
SI-786-4-360	Small	8 1/2 in	216 mm
SI-786-4-360A	Medium	10 1/2 in	267 mm
SI-786-4-360B	Large	12 1/2 in	318 mm

WUNDHAKEN - RETRACTORS

Abdominaux (Anneaux Bookwalter)
Abdominal (Bookwalter Rings)
Bauch (Bookwalter Ringe)
Abdominales (Anillos Bookwalter)

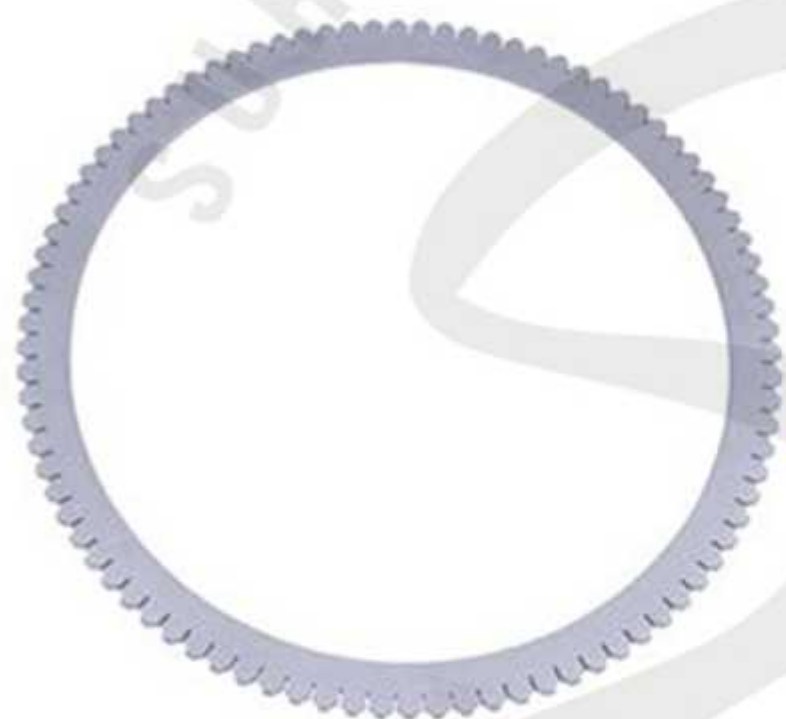

Bookwalter Suture Ring

CODE	DESCRIPTION	DIAMETER
SI-786-4-361	Small, Round	9 1/2 in 241 mm



Bookwalter Round Ring Segmented

CODE	DESCRIPTION	DIAMETER
SI-786-4-362	Small, 1 Pair	8 1/2 in 216 mm
SI-786-4-362A	Medium, 1 Pair	10 1/2 in 267 mm
SI-786-4-362B	Large, with Suture Slots	16 in 406 mm

WUNDHAKEN - RETRACTORS

Abdominaux (Anneaux Bookwalter)
Abdominal (Bookwalter Rings)
Bauch (Bookwalter Ringe)
Abdominales (Anillos Bookwalter)

Bookwalter Segmented Retractor Ring

CODE	DESCRIPTION	DIMENSIONS	
SI-786-4-363	Small, Consists of One 8 1/2 in Round Ring and Two 4 in Straight Segments	8 1/2 x 14 in	216 x 356 mm
SI-786-4-363A	Medium, Consists of One 10 1/2 in Round Ring and Two 8 in Straight Segments	10 1/2 x 19 1/2 in	267 x 495 mm
SI-786-4-363B	Large, Consists of One 12 1/2 in Round Ring and Two 6 in Straight Segments	12 1/2 x 19 1/2 in	318 x 495 mm

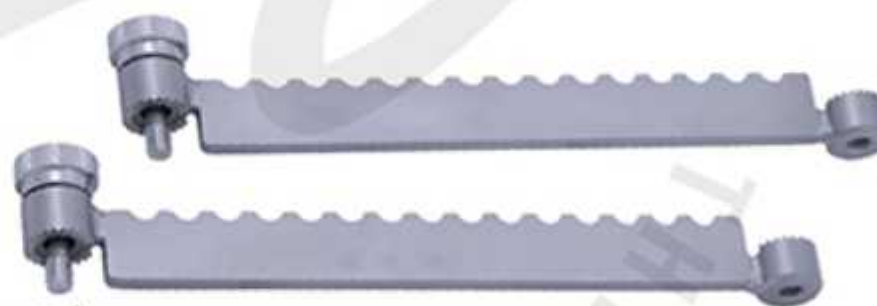
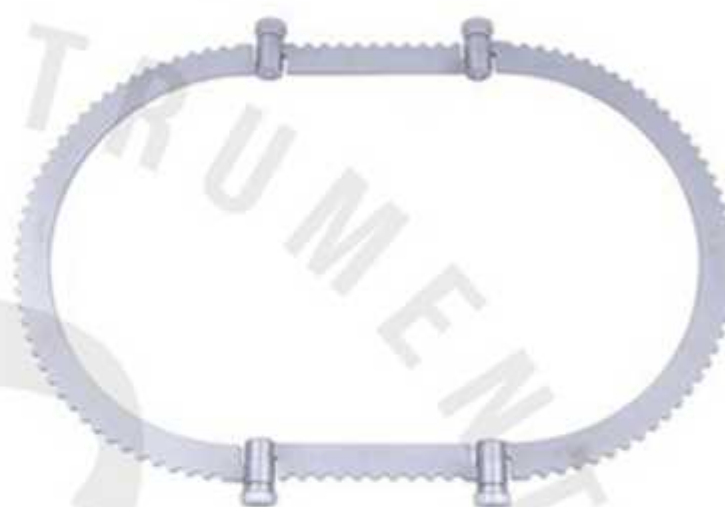

Bookwalter Segmented Ring (Straight Segments)

CODE	DESCRIPTION	LENGTH	
SI-786-4-364	Straight Ring Segment (Pair)	4 in	102 mm
SI-786-4-364A	Straight Ring Segment (Pair)	6 in	152 mm
SI-786-4-364B	Straight Ring Segment (Pair)	8 in	203 mm



Bookwalter Universal Ring Segmented Ring Screw

CODE	DESCRIPTION	LENGTH	
SI-786-4-365	Screw Only, One Each	15/16 in	24 mm

WUNDHAKEN - RETRACTORS

Abdominal (lames universelles)
Abdominal (Universal Blades)
Bauch (Universalklingen)
Abdominal (cuchillas universales)

Universal Ring Deaver Retractor Blade

CODE	DESCRIPTION	DIMENSIONS	
SI-786-3-367		1 x 3 1/2 in	25 x 89 mm
SI-786-3-367A		1 x 5 in	25 x 127 mm
SI-786-3-367B		2 x 6 1/2 in	51 x 165 mm
SI-786-3-367C	Titanium	2/3 x 2 1/4 in	16.9 x 57 mm
SI-786-3-367D	Titanium	1 x 5 in	25 x 127 mm
SI-786-3-367E	Titanium	2 x 3 1/2 in	51 x 89 mm
SI-786-3-367F	Titanium	3 x 6 1/2 in	76 x 165 mm



Universal Ring Big Boy Retractor Blade

CODE	DESCRIPTION	LENGTH
SI-786-3-366	Fenestrated	2 x 6 1/2 in
SI-786-3-366A	Fenestrated	3 x 6 1/2 in



Universal Ring Harrington Retractor Blade

CODE	DIMENSIONS	
SI-786-3-368	2/3 x 2 1/4 in	16.9 x 57 mm
SI-786-3-368A	3 x 10 1/2 in	76 x 267 mm

WUNDHAKEN - RETRACTORS

Abdominal (lames universelles)
Abdominal (Universal Blades)
Bauch (Universalklingen)
Abdominal (cuchillas universales)



Universal Ring Kelly Retractor Blade

CODE	DESCRIPTION	DIMENSIONS	
SI-786-3-369		1 x 3 in	51 x 76 mm
SI-786-3-369A	Aluminium	2 x 5 in	51 x 127 mm
SI-786-3-369B	Aluminium	2 x 6 in	51 x 152 mm
SI-786-3-369C	Aluminium	2 x 6 in	51 x 152 mm
SI-786-3-369D		1/2 x 5 x 3 1/2 in	64 x 127 x 89 mm
SI-786-3-369E	Titanium	2 1/2 x 8 x 3 1/2 in	64 x 203 x 89 mm
SI-786-3-369F	Titanium	3 x 10 1/2 in	76 x 267 mm



Universal Ring Meyerding Retractor Blade Without Teeth

CODE	DESCRIPTION	DIMENSIONS	
SI-786-3-370	Titanium	2 x 4 in	51 x 102 mm
SI-786-3-370A	Titanium	2 1/2 x 3 in	64 x 76 mm



Universal Ring Pediatric Harrington Retractor Blade

CODE	DESCRIPTION	DIMENSIONS	
SI-786-3-371	Ring Pediatric Harrington Retractor Blade	2 x 8 in	51 x 203 mm

WUNDHAKEN - RETRACTORS

Abdominal (lames universelles)
Abdominal (Universal Blades)
Bauch (Universalklingen)
Abdominal (cuchillas universales)



Universal Ring Retractor Blade

CODE

SI-786-3-372

SI-786-3-372A

DESCRIPTION

Fence, Rigid

Titanium

DIMENSIONS

2 x 3 3/4 in 51 x 95 mm

3 1/2 x 3 3/4 in 89 x 95 mm

Universal Ring Scoville Retractor Blade

CODE

SI-786-3-373

DESCRIPTION

Large



WUNDHAKEN - RETRACTORS

Abdominal (lames universelles)
Abdominal (Universal Blades)
Bauch (Universalklingen)
Abdominal (cuchillas universales)



Universal Ring Retractor Blade

CODE	DESCRIPTION	LENGTH	
SI-786-3-374	Malleable, With Lip	1 x 5 in	25 x127 mm
SI-786-3-374A	Malleable, With Lip	2 x 8 in	51 x203 mm
SI-786-3-374B	Malleable, With Lip	1 x 5 in	25 x127 mm
SI-786-3-374C	Malleable, With Lip	6 x 9 in	152 x228 mm
SI-786-3-374D	Malleable, With Lip	4 x 10 in	102 x254 mm



Universal Ring Retractor Blade

CODE	DESCRIPTION	LENGTH	
SI-786-3-375	Malleable, No Lip	6 x 9 in	152 x 229 mm
SI-786-3-375A	Malleable, No Lip	6 x 12 in	152 x 305 mm

WUNDHAKEN - RETRACTORS

Nervure (autorétentive)
Rib (Self-Retaining)
Rippe (selbsthaltend)
Costilla (autorretención)



Burford-Finochietto Rib Retractor

CODE	DESCRIPTION	TOTAL OPENING	BLADE	ARM LENGTH	LENGTH
SI-786-3-376	Child Model, Self-Retaining with rack and pinion Action, Aluminium	6 in 152 mm	Large: 1 5/8 x 1 7/8 in 41 x 48 mm Small: 1 5/8 x 1 3/8 in 41 x 35 mm	6 in 152 mm	6 in 152 mm
SI-786-3-376A	Self-Retaining, Two Sets of Detachable Blades, Curved Arms	10 in 254 mm	Large: 2 1/2 x 2 5/8 in 64 x 67 mm Small: 2 1/2 x 1 3/4 in 64 x 44 mm	9 1/2 in 241 mm	10 in 254 mm
SI-786-3-376B	Self-Retaining, Two Sets of Detachable Blades, Curved Arms	10 in 254 mm	Large: 2 1/2 x 2 4/5 in 64 x 71 mm Small: 2 1/2 x 1 3/5 in 64 x 41 mm	9 3/4 in 248 mm	10 in 254 mm



Cooley Rib Retractor

Aluminum Arms and Blades

CODE	DESCRIPTION	BLADE LENGTH	BLADE DEPTH	SPREAD ARM	LENGTH
SI-786-3-377	Pediatric	1 in 25 mm	5/8 in 16 mm	4 3/4 in 121 mm	3 1/8 in 79 mm
SI-786-3-377A	Adult	1 3/8 in 35 mm	1 3/8 in 35 mm	7 in 178 mm	4 1/4 in 108 mm

WUNDHAKEN – RETRACTORS

Nervure (autorétentive)
Rib (Self-Retaining)
Rippe (selbsthaltend)
Costilla (autorretención)



Finochietto Rib Retractor

Self-Retaining With Rack and Pinion Action

CODE	DESCRIPTION	TOTAL OPENING	BLADE (W X D)	ARM LENGTH	LENGTH
SI-786-3-378	Infant	2 1/2 in 64 mm	3/4 x 1 3/16 in 19 x 30 mm	3 in 76 mm	2 1/2 in 64 mm
SI-786-3-378A	Pediatric	6 1/2 in 165 mm	1 3/4 x 1 3/4 in 44 x 44 mm	6 in 152 mm	6 in 152 mm



Haight-Finochietto Rib Retractor

Self-Retaining With Rack and Pinion Action

CODE	DESCRIPTION	TOTAL OPENING	BLADE (W X D)	ARM LENGTH	LENGTH
SI-786-3-379	Rib Retractor	4 in 102 mm	1 1/4 x 1 3/16 in 32 x 30 mm	3 1/4 in 83 mm	4 in 102 mm

WUNDHAKEN - RETRACTORS

Nervure (autorétentive)
Rib (Self-Retaining)
Rippe (selbsthaltend)
Costilla (autorretención)



Rib Retractor
Infant, Self-Retaining With Rack and Pinion Action, Aluminium

CODE	ARM LENGTH	BLADE WIDTH	BLADE DEPTH	LENGTH
SI-786-3-380	3 in 76 mm	3/4 in 19 mm	13/16 in 21 mm	2 1/2 in 64 mm



Tuffier Rib Retractor
Self-Retaining

CODE	DESCRIPTION	LENGTH
SI-786-3-381	Roughened Blades	3 x 2 1/2 in 76 x 64 mm
SI-786-3-381A	Serrated Blades	4 3/4 x 6 in 146 x 152 mm

Costotomes
Rib shears
Costótomos
Costotomi

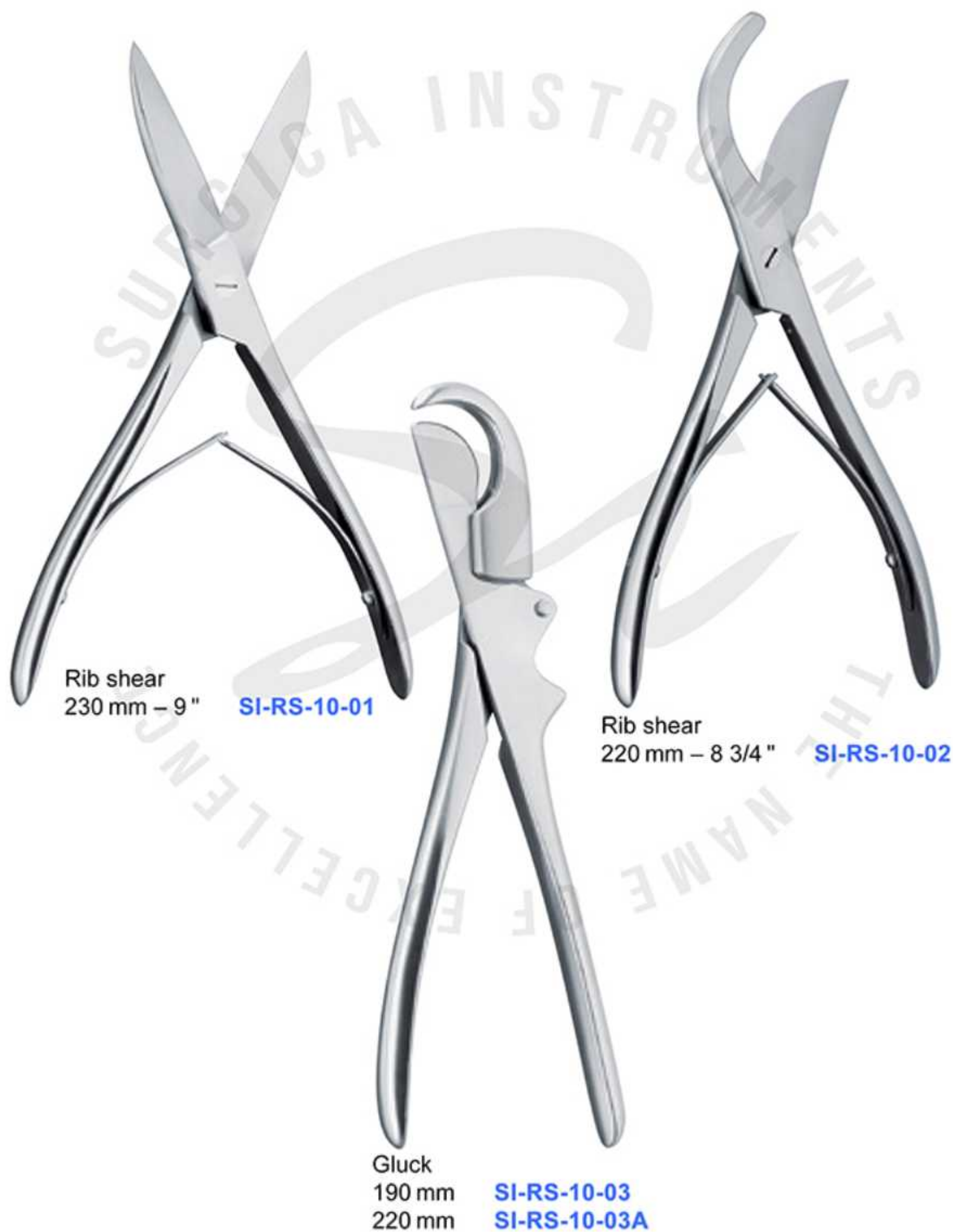

Costotomes
Rib shears
Costótomos
Costotomi



Stille
210 mm – 8 1/4"
SI-RS-10-04



Brunner
320 mm – 12 1/2"
SI-RS-10-06
For the right and left hand



Lebsche
245 mm – 9 3/4"
SI-RS-10-05

Costotomes
Rib shears
Costótomos
Costotomi



Sauerbruch-Frey
360 mm – 14 1/4"
SI-RS-10-07



Sauerbruch
260 mm – 10 1/4"
SI-RS-10-08

Costotomes
Rib shears
Costótomos
Costotomi



Giertz-Stille
270 mm – 10 3/4"
SI-RS-10-09



Bethune
340 mm – 13 1/2"
SI-RS-10-10

Ecarteurs des côtes
Rib retractors
Separadores costales
Divaricatori costali

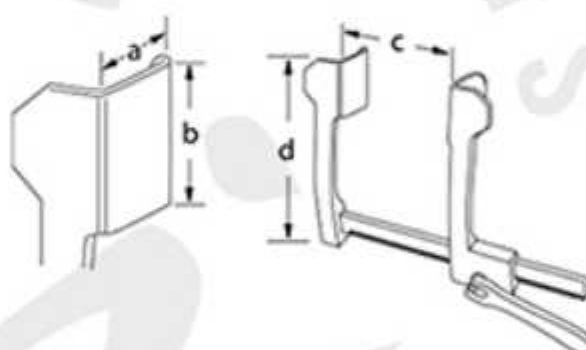

Mercedes Thoraxsperrer

	a	b	c	d
SI-RR-10-01	45 mm	68 mm	285 mm	185 mm
	70 mm	75 mm		

For adults, with 2 pairs of interchangeable blades with ball snap system, stainless steel

Pair of blades

	a	b
SI-RR-10-01A	45 mm	68 mm
SI-RR-10-01B	70 mm	75 mm

Stainless steel

Ecarteurs des côtes
Rib retractors
Separadores costales
Divaricatori costali



I.M.A.
SI-RR-10-02
Complete

1 x
SI-RR-10-02A
Frame

1 x
SI-RR-10-02B
Double blade

1 x
SI-RR-10-02C
Double blade with groove

1 x
SI-RR-10-02D
T-holder

2 x
SI-RR-10-02E
Universal clamp

2 x
SI-RR-10-02F
Cooley blade small

1 x
SI-RR-10-02G
Cooley blade medium

1 x
SI-RR-10-02H
Cooley blade large

2 x
SI-RR-10-02I
Ribbon blade malleable

THORAX, LUNG

Spatules pulmonaires
Lung spatula
Espátula pulmonar
Spatole per polmone



Allison
300 mm
320 mm
SI-LS-10-01
SI-LS-10-01A

Allison
260 mm
310 mm
SI-LS-10-02
SI-LS-10-02A

Rapprocheurs
Rib contractors
Aproximadores para costillas
Approssimatori costali



Bailey
160 mm – 6 1/4 "
SI-RC-10-01



Bailey-Baby
140 mm – 5 1/2 "
SI-RC-10-02



Bailey-Gibbon
160 mm – 6 1/4 "
SI-RC-10-03

Rapprocheurs
Rib contractors
Aproximadores para costillas
Approssimatori costali



Sellers
190 mm – 7 1/2 "
SI-RC-10-04



Lemmon
145 mm **SI-RC-10-05**
180 mm **SI-RC-10-05A**

Si **SURGICA**
INSTRUMENTS
THE NAME OF EXCELLENCE



ORTHOPEDIC — BONE SURGERY INSTRUMENTS

- AMPUTATING AND RESECTION SAWS
- RASPS AND FILES
- BONE MALLETS
- BONE CHISELS AND GOUGES
- BONE CURETTES
- PERIOSTEAL RESPIRATORIES - ELEVATOR
- ABDOMINAL SPATULAS
- & MORE

ORTHOPEDIC – BONE SURGERY

Scies à amputation et résection
Amputating and resection saws
Sierra para amputación y resección
Seghe per amputazione



Charriere
350 mm – 13 3/4"
SI-786-5-01



Spare saw blades
12 mm SI-786-5-02
15 mm SI-786-5-02A



Helferich-Bier
390 mm – 15 1/2"
SI-786-5-04



Spare saw blades
3 mm SI-786-5-03
5 mm SI-786-5-03A
7 mm SI-786-5-03B

Scies à amputation et résection
Amputating and resection saws
Sierra para amputación y resección
Seghe per amputazione



Satterlee
310 mm – 12 1/4 "
SI-786-5-05



Charrière
270 mm – 10 3/4 " SI-786-5-07
300 mm – 12 " SI-786-5-07A
340 mm – 13 1/2 " SI-786-5-07B



Langenbeck
230 mm – 9 "
SI-786-5-06

Râpes, limes
Rasps, files
Escofinas, limas
Raspe, lime



Putti
270 mm – 10 3/4 "
SI-786-5-08



Putti
300 mm – 12 "
SI-786-5-09



Semicircular
280 mm – 11 "
SI-786-5-10



Semicircular
245 mm – 9 3/4 "
x = 13 mm
SI-786-5-11



Flate
220 mm – 8 3/4 "
x = 20 mm
SI-786-5-12

Maillets
Mallets
Martillos
Martelli



Doyen
195 mm – 7 3/4"
25 mm Ø – 120 g
30 mm Ø – 180 g
35 mm Ø – 260 g

SI-786-5-13
SI-786-5-13A
SI-786-5-13B



Collin
200 mm – 8"
30 mm Ø – 220 g

SI-786-5-14



Hajek
215 mm – 8 1/2"
27 mm Ø – 140 g

SI-786-5-15



Kirk
190 mm – 7 1/2"
38 mm Ø – 750 g

SI-786-5-16



Partsch
180 mm – 7"
22 mm Ø – 200 g

SI-786-5-17

Maillets
Mallets
Martillos
Martelli



Lucae
190 mm – 7 1/2"
19 mm Ø – 230 g
25 mm Ø – 260 g

SI-786-5-18
SI-786-5-18A



Bergmann
245 mm – 9 3/4"
45 mm Ø – 300 g

SI-786-5-19



Ombredanne
240 mm – 9 1/2"
40 mm Ø – 550 g

SI-786-5-20



Heath
40 mm Ø – 700 g
45 mm Ø – 1000 g
Copper filled head

180 mm – 7" **SI-786-5-21**
200 mm – 8" **SI-786-5-21A**



Solid steel, with plastic faces
190 mm – 7 1/2"
25 mm Ø – 205 g
SI-786-5-22

Maillets
Mallets
Martillos
Martelli



Cottle
185 mm – 7 1/4 "
30 mm Ø – 240 g
SI-786-5-23
1 side flat/1 side convex



Mallet
280 mm – 11 "
35 mm Ø – 450 g
50 mm Ø – 900 g

SI-786-5-24
SI-786-5-24A



Williger
240 mm – 9 1/2 "
28 mm Ø – 340 g
30 mm Ø – 400 g
Lead filled

SI-786-5-25
SI-786-5-25A



Williger
165 mm – 6 1/2 "
20 mm Ø – 140 g
SI-786-5-26



Mead
170 mm – 6 3/4 "
26 mm Ø – 320 g
SI-786-5-27
Steel solid, with plastic faces

Maillets
Mallets
Martillos
Martelli



Mallet
225 mm – 8 3/4"
37 mm Ø – 370 g
SI-786-5-28
Head solid steel,
with Ferrozell faces



Mallet
240 mm – 9 1/2"
30 mm Ø – 480 g
SI-786-5-29
Head solid steel,
Ferozell handle



Mallet
260 mm – 10 1/4"
42 mm Ø – 250 g
SI-786-5-30
Ferozell, without
lead

42 mm Ø – 400 g
SI-786-5-30A
Plastic, lead filled



Mallet
265 mm – 10 1/2"
30 mm Ø – 450 g
50 mm Ø – 900 g
SI-786-5-31
SI-786-5-31A



Collin Bone Mallet
20 cm - 8"
30 mm Ø - 220 g
SI-786-5-32

Ciseaux-burins, gouges
Bone chisels and gouges
Cinceles, gubias
Scalpelli, sgorbi



Key
90 mm – 3 1/2 "
SI-786-5-32B

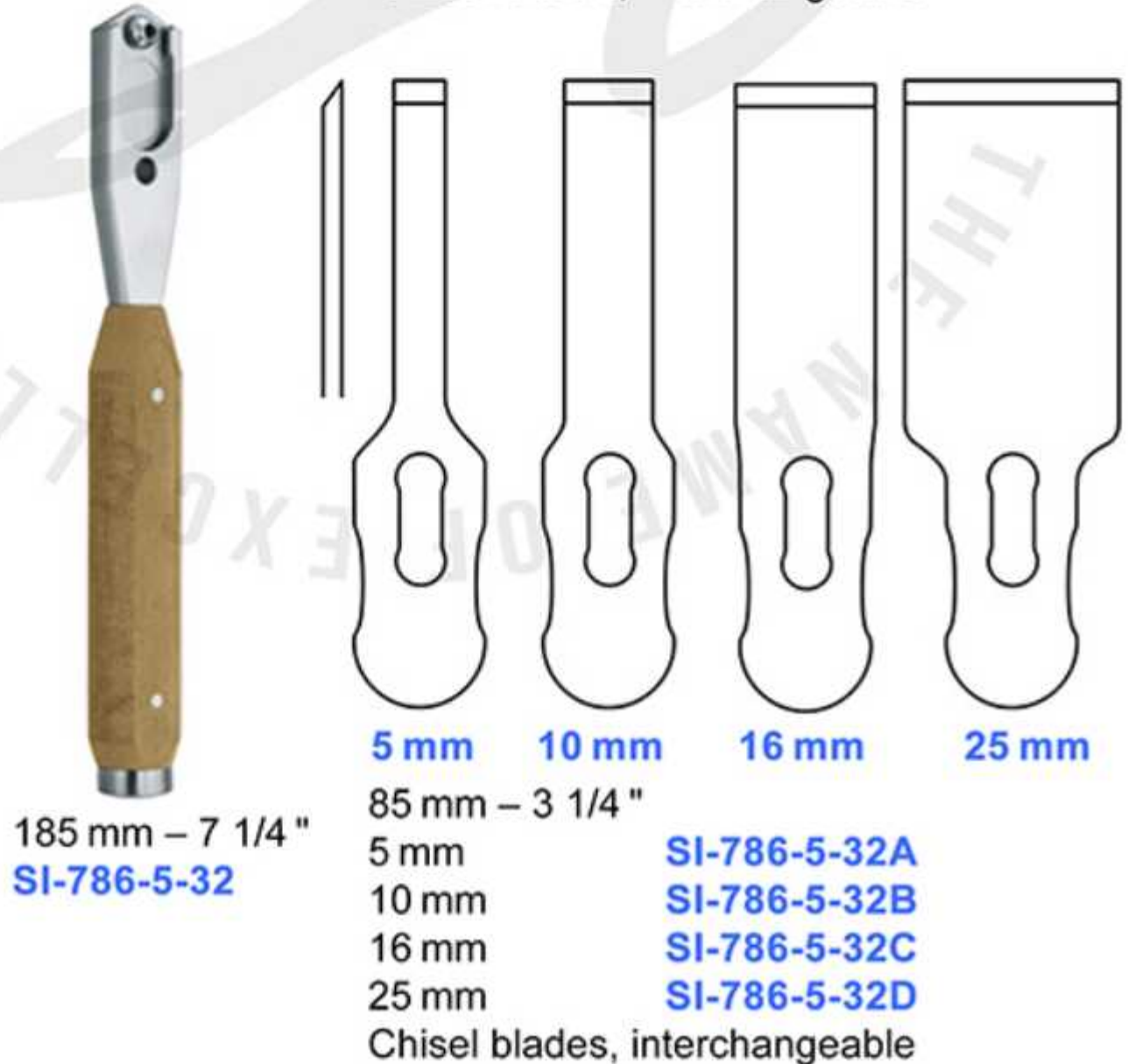

Ciseaux-burins, gouges
Bone chisels and gouges
Cinceles, gubias
Scalpelli, sgorbi



135 mm – 5 1/4 "

8 mm **SI-786-5-33**
10 mm **SI-786-5-33A**
12 mm **SI-786-5-33B**
14 mm **SI-786-5-33C**
16 mm **SI-786-5-33D**



135 mm – 5 1/4 "

8 mm **SI-786-5-34**
10 mm **SI-786-5-34A**
12 mm **SI-786-5-34B**
14 mm **SI-786-5-34C**
16 mm **SI-786-5-34D**



135 mm – 5 1/4 "

8 mm **SI-786-5-35**
10 mm **SI-786-5-35A**
12 mm **SI-786-5-35B**
14 mm **SI-786-5-35C**
16 mm **SI-786-5-35D**



Lucas
160 mm – 6 1/4 "

4 mm **SI-786-5-36**
6 mm **SI-786-5-36A**
Chisel



Lucas
160 mm – 6 1/4 "

3 mm **SI-786-5-37**
4 mm **SI-786-5-37A**
5 mm **SI-786-5-37B**
6 mm **SI-786-5-37C**
Gouge



Alexander

180 mm – 7 "
4 mm **SI-786-5-38**
6 mm **SI-786-5-38A**
8 mm **SI-786-5-38B**
10 mm **SI-786-5-38C**
12 mm **SI-786-5-38D**
14 mm **SI-786-5-38E**



180 mm – 7 "

SI-786-5-39
SI-786-5-39A
SI-786-5-39B
SI-786-5-39C
SI-786-5-39D
SI-786-5-39E

Ciseaux-burins, gouges
Bone chisels and gouges
Cinceles, gubias
Scalpelli, sgorbi



Partsch

	115 mm – 4 1/2 "	135 mm – 5 1/4 "	170 mm – 6 3/4 "
2 mm	SI-786-5-40	SI-786-5-40A	SI-786-5-40B
3 mm	SI-786-5-40C	SI-786-5-40D	SI-786-5-40E
4 mm	SI-786-5-40F	SI-786-5-40G	SI-786-5-40H
5 mm	SI-786-5-40I	SI-786-5-40J	SI-786-5-40K
6 mm	SI-786-5-40L	SI-786-5-40M	SI-786-5-40N
7 mm	SI-786-5-40O	SI-786-5-40P	SI-786-5-40Q
8 mm	SI-786-5-40R	SI-786-5-40S	SI-786-5-40T

Partsch

	115 mm – 4 1/2 "	135 mm – 5 1/4 "	170 mm – 6 3/4 "
2 mm	SI-786-5-41	SI-786-5-41A	SI-786-5-41B
3 mm	SI-786-5-41C	SI-786-5-41D	SI-786-5-41E
4 mm	SI-786-5-41F	SI-786-5-41G	SI-786-5-41H
5 mm	SI-786-5-41I	SI-786-5-41J	SI-786-5-41K
6 mm	SI-786-5-41L	SI-786-5-41M	SI-786-5-41N
7 mm	SI-786-5-41O	SI-786-5-41P	SI-786-5-41Q
8 mm	SI-786-5-41R	SI-786-5-41S	SI-786-5-41T



Ciseaux-burins, gouges
Bone chisels and gouges
Cinceles, gubias
Scalpelli, sgorbi



Lexer

220 mm – 8 3/4 "
7 mm SI-786-5-42
10 mm SI-786-5-42B
15 mm SI-786-5-42D
20 mm SI-786-5-42F
25 mm SI-786-5-42H
30 mm SI-786-5-42J

300 mm – 12 "
SI-786-5-42A
SI-786-5-42C
SI-786-5-42 E
SI-786-5-42G
SI-786-5-42 I
SI-786-5-42 K

220 mm – 8 3/4 "
SI-786-5-43
SI-786-5-43B
SI-786-5-43D
SI-786-5-43F
SI-786-5-43H
SI-786-5-43J

300 mm – 12 "
SI-786-5-43A
SI-786-5-43C
SI-786-5-43E
SI-786-5-43G
SI-786-5-43I
SI-786-5-43K

Ferrozell handle

Ciseaux-burins, gouges
Bone chisels and gouges
Cinceles, gubias
Scalpelli, sgorbi



Mini-Lexer

180 mm – 7 "

4 mm **SI-786-5-44**
6 mm **SI-786-5-44A**
8 mm **SI-786-5-44B**
10 mm **SI-786-5-44C**
12 mm **SI-786-5-44D**

Ferrozell handle

180 mm – 7 "

SI-786-5-45
SI-786-5-45A
SI-786-5-45B
SI-786-5-45C
SI-786-5-45D

Ciseaux-burins, gouges
Bone chisels and gouges
Cinceles, gubias
Scalpelli, sgorbi

SURGICA INSTRUMENTS



8 mm	SI-786-5-46	SI-786-5-47	SI-786-5-48	SI-786-5-49	SI-786-5-50
10 mm	SI-786-5-46A	SI-786-5-47A	SI-786-5-48A	SI-786-5-49A	SI-786-5-50A
12 mm	SI-786-5-46B	SI-786-5-47B	SI-786-5-48B	SI-786-5-49B	SI-786-5-50B
15 mm	SI-786-5-46C	SI-786-5-47C	SI-786-5-48C	SI-786-5-49C	SI-786-5-50C
20 mm	SI-786-5-46D	SI-786-5-47D	SI-786-5-48D	SI-786-5-49D	SI-786-5-50D
25 mm	SI-786-5-46E	SI-786-5-47E	SI-786-5-48E	SI-786-5-49E	SI-786-5-50E

Stille
200 mm – 8"

Ciseaux-burins, gouges
Bone chisels and gouges
Cinceles, gubias
Scalpelli, sgorbi



Smith-Petersen
200 mm – 8"

6 mm
9 mm
13 mm
16 mm
19 mm
25 mm
32 mm

SI-786-5-51
SI-786-5-51A
SI-786-5-51B
SI-786-5-51C
SI-786-5-51D
SI-786-5-51E
SI-786-5-51F

SI-786-5-52
SI-786-5-52A
SI-786-5-52B
SI-786-5-52C
SI-786-5-52D
SI-786-5-52E
SI-786-5-52F

SI-786-5-53
SI-786-5-53A
SI-786-5-53B
SI-786-5-53C
SI-786-5-53D
SI-786-5-53E
SI-786-5-53F

SI-786-5-54
SI-786-5-54A
SI-786-5-54B
SI-786-5-54C
SI-786-5-54D
SI-786-5-54E
SI-786-5-54F

Ciseaux-burins, gouges
Bone chisels and gouges
Cinceles, gubias
Scalpelli, sgorbi



6 mm	SI-786-5-55	SI-786-5-56	SI-786-5-57	SI-786-5-58	SI-786-5-59
13 mm	SI-786-5-55A	SI-786-5-56A	SI-786-5-57A	SI-786-5-58A	SI-786-5-59A
19 mm	SI-786-5-55B	SI-786-5-56B	SI-786-5-57B	SI-786-5-58B	SI-786-5-59B
25 mm	SI-786-5-55C	SI-786-5-56C	SI-786-5-57C	SI-786-5-58C	SI-786-5-59C
32 mm	SI-786-5-55D	SI-786-5-56D	SI-786-5-57D	SI-786-5-58D	SI-786-5-59D

Hibbs
240 mm–9 1/2 "

Ciseaux-burins, gouges
Bone chisels and gouges
Cinceles, gubias
Scalpelli, sgorbi



Obwegeser
235 mm – 9 1/4 "
11 mm
SI-786-5-60



Obwegeser
215 mm – 8 1/2 "

7 mm
SI-786-5-61



10 mm
SI-786-5-62

Curettes tranchantes
Bone cures
Cucharillas cortantes
Cucchiai taglienti



Volkman
170 mm – 6 3/4"

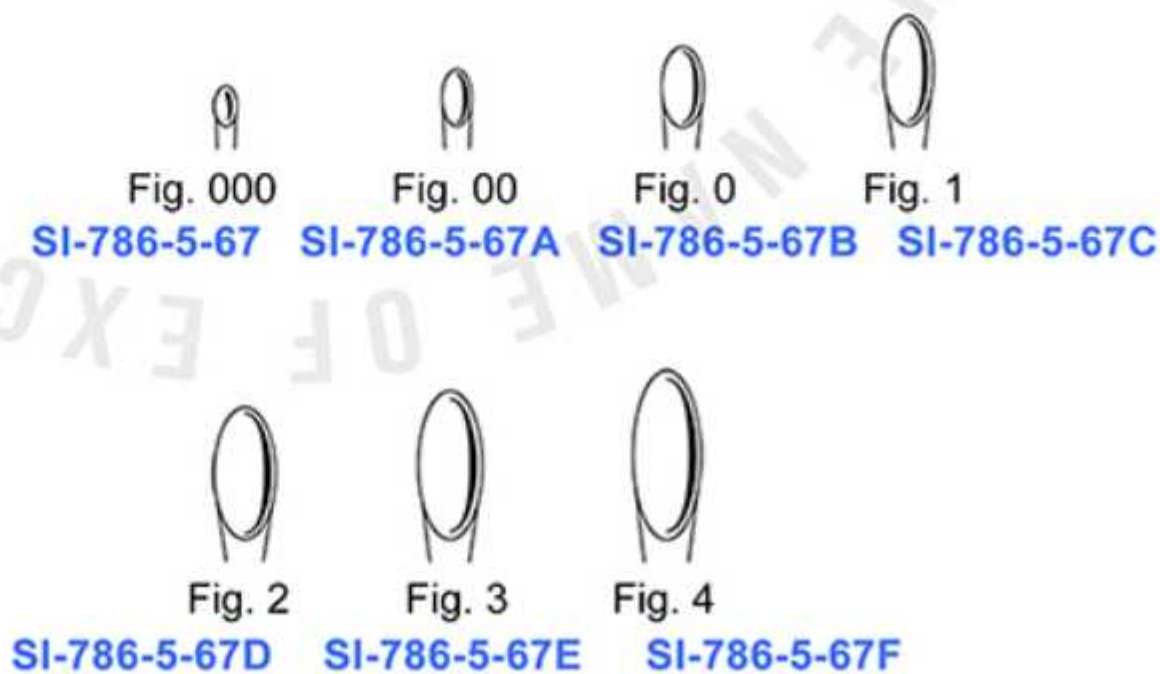

Curettes tranchantes
Bone curettes
Cucharillas cortantes
Cucchiai taglienti

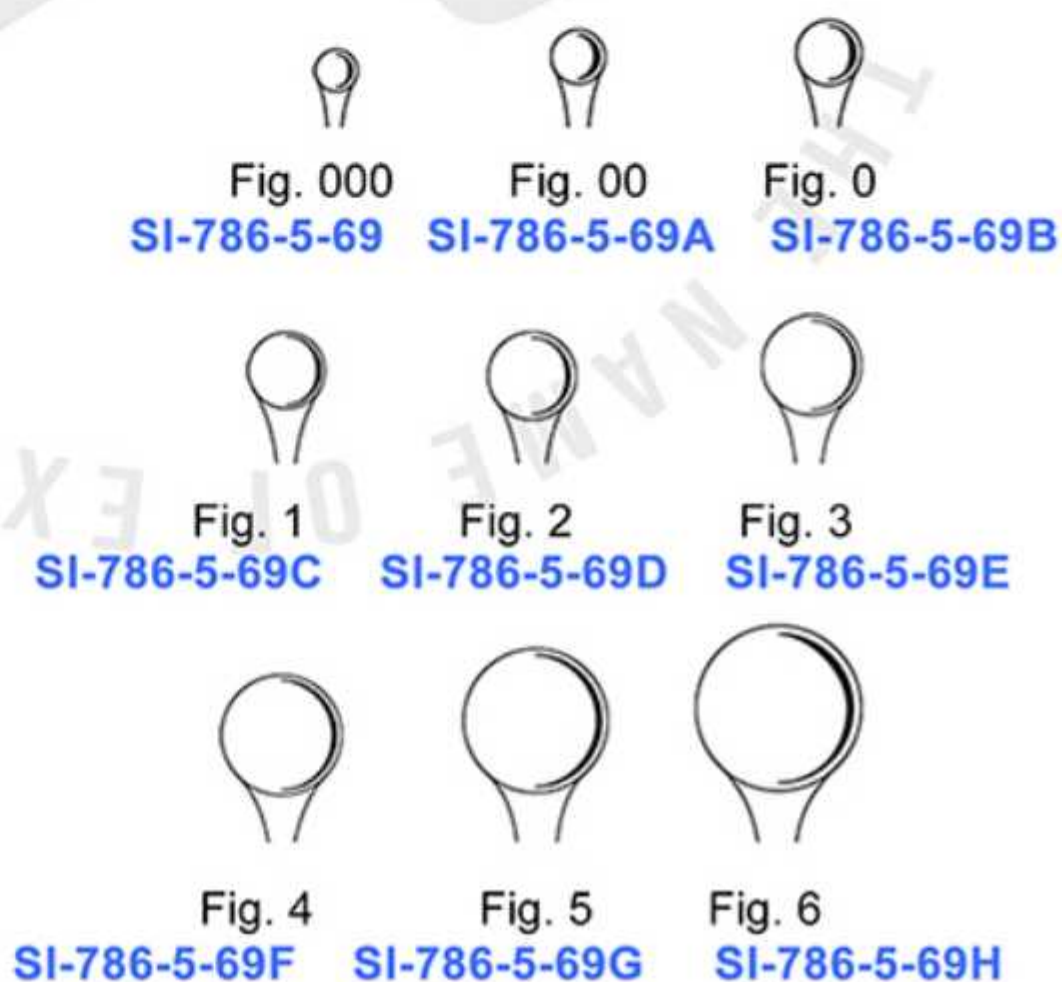
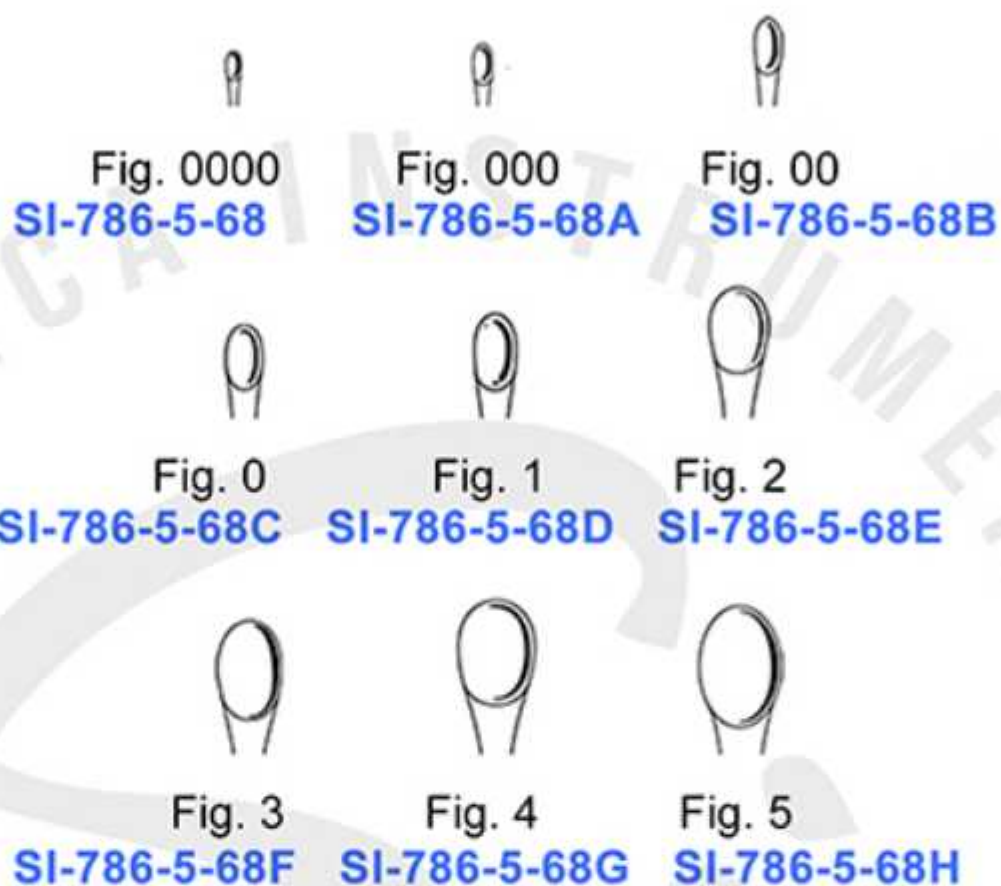

Curettes tranchantes
Bone curettes
Cucharillas cortantes
Cucchiai taglienti

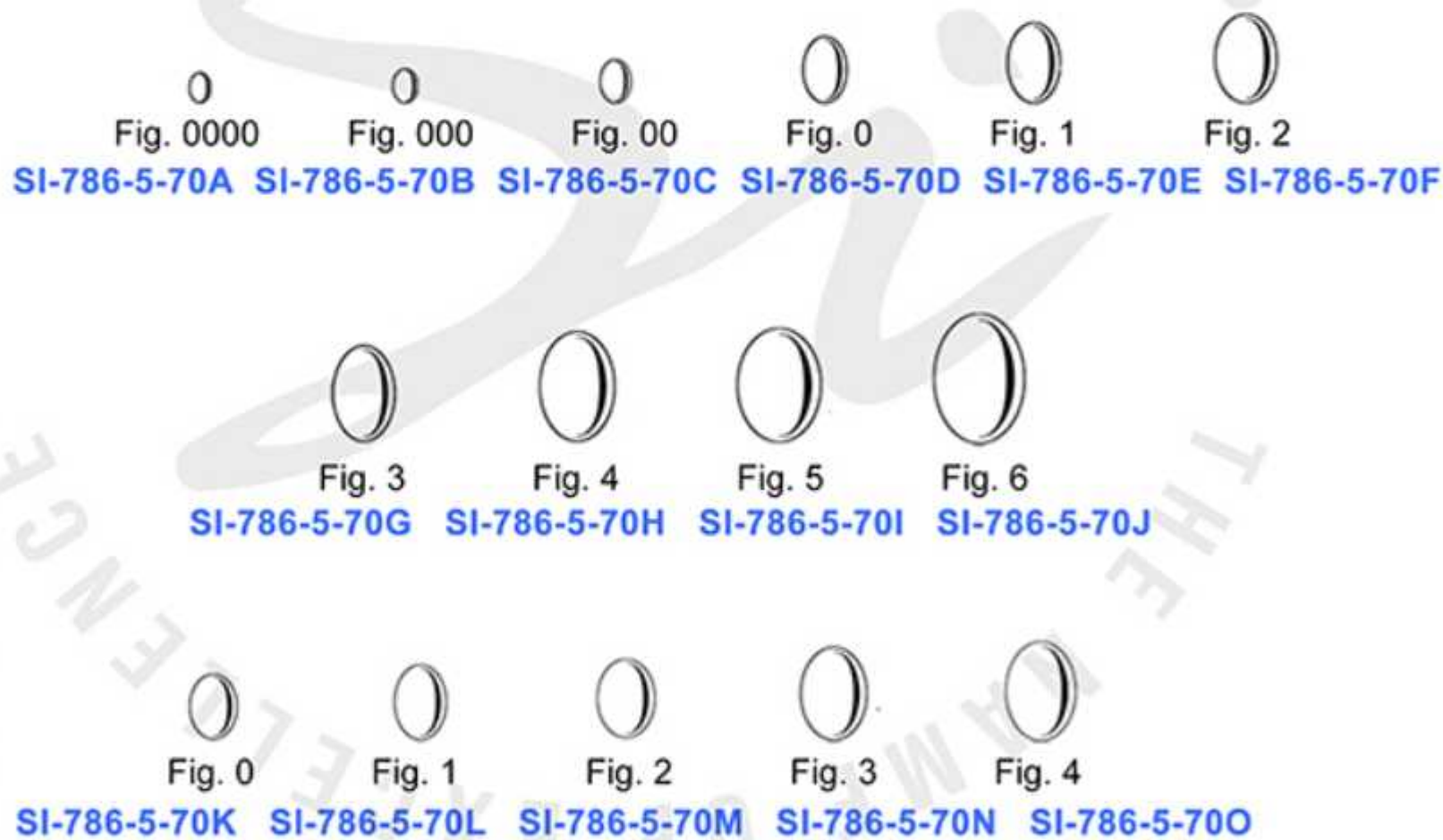

Volkman
SI-786-5-70
185 mm – 7 1/4 "
190 mm – 7 1/2 "
275 mm – 10 3/4 "
oval, with plastic handle

Curettes tranchantes
Bone cures
Cucharillas cortantes
Cucchiai taglienti



Bruns
230 mm – 9"
Straight

Fig. 0000 SI-786-5-71 Fig. 000 SI-786-5-71A Fig. 00 SI-786-5-71B Fig. 0 SI-786-5-71C Fig. 1 SI-786-5-71D

Fig. 2 SI-786-5-71E Fig. 3 SI-786-5-71F Fig. 4 SI-786-5-71G Fig. 5 SI-786-5-71H Fig. 6 SI-786-5-71I

Curettes tranchantes
Bone curettes
Cucharillas cortantes
Cucchiai taglienti



Bruns
230 mm – 9"
Curved

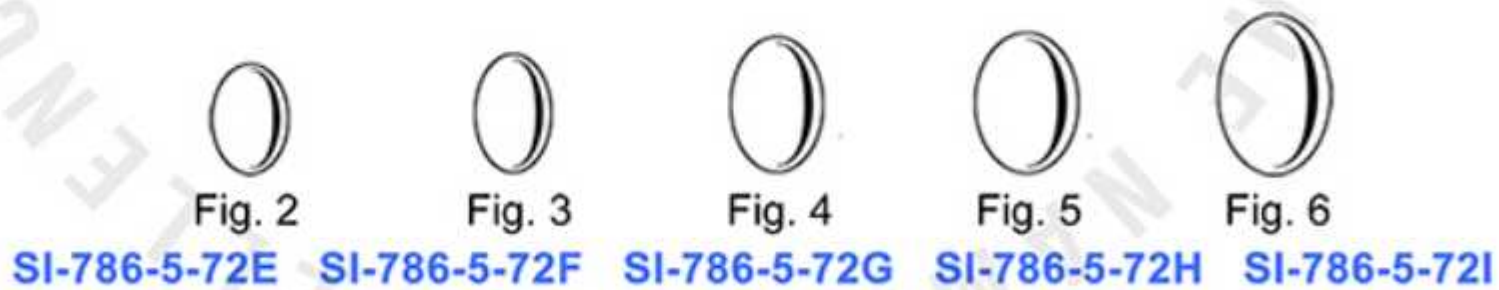

Curettes tranchantes
Bone cures
Cucharillas cortantes
Cucchiai taglienti



Halle
210 mm – 8 1/4"
Flexible



Fig. 1

SI-786-5-73



Fig. 2

SI-786-5-73A



Fig. 3

SI-786-5-73B



Uffenorde
Fig. 1
170 mm – 6 3/4"
SI-786-5-74



Uffenorde
Fig. 2
170 mm – 6 3/4"
SI-786-5-75

Curettes tranchantes
Bone curettes
Cucharillas cortantes
Cucchiai taglienti



Bruns
230 mm – 9"
Solid



Fig. 00

SI-786-5-76



Fig. 0

SI-786-5-76A



Fig. 1

SI-786-5-76B



Fig. 2

SI-786-5-76C



Fig. 3

SI-786-5-76D



Fig. 4

SI-786-5-76E



Fig. 5

SI-786-5-76F



Fig. 6

SI-786-5-76G



Schroeder
300 mm – 12"
Sharp/Rigid



Fig. 1

SI-786-5-77



Fig. 2

SI-786-5-77A



Fig. 3

SI-786-5-77B



Fig. 4

SI-786-5-77C



Fig. 5

SI-786-5-77D



Fig. 6

SI-786-5-77E

Curettes tranchantes
Bone curettes
Cucharillas cortantes
Cucchiai taglienti



Simon
240 mm – 9 1/2"
Sharp/Rigid

Fig. 0000 SI-786-5-78 Fig. 000 SI-786-5-78A Fig. 00 SI-786-5-78B Fig. 0 SI-786-5-78C



Simon
250 mm – 9 3/4"
Sharp/Rigid

Fig. 1 SI-786-5-79 Fig. 2 SI-786-5-79A Fig. 3 SI-786-5-79B
Fig. 4 SI-786-5-79C Fig. 5 SI-786-5-79D Fig. 6 SI-786-5-79E

Curettes tranchantes
Bone currettes
Cucharillas cortantes
Cucchiai taglienti



Daubenspeck
200 mm – 8"



Fig. 0000 2.8 mm SI-786-5-80
Fig. 000 3.6 mm SI-786-5-80A
Fig. 00 4.4 mm SI-786-5-80B
Fig. 0 5.2 mm SI-786-5-80C



Lempert
215 mm – 8 1/2"

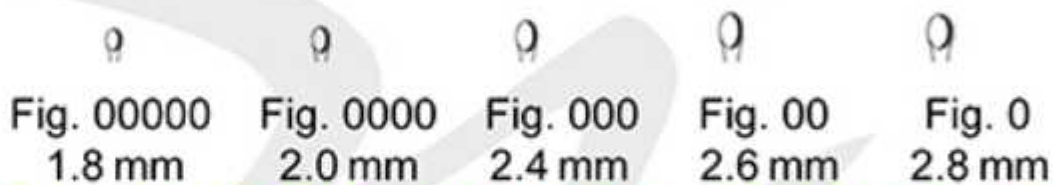

Fig. 00000 1.8 mm SI-786-5-82
Fig. 0000 2.0 mm SI-786-5-82A
Fig. 000 2.4 mm SI-786-5-82B
Fig. 00 2.6 mm SI-786-5-82C
Fig. 0 2.8 mm SI-786-5-82D



Scoville
250 mm – 9 3/4"
Oval



Fig. 1 SI-786-5-81
Fig. 2 SI-786-5-81A
Fig. 3 SI-786-5-81B

Rugines – Décolleurs pour la chirurgie maxillo-faciale
 Periosteal elevators for maxillo-facial surgery
 Periostótomos para la cirugía maxilofacial
 Raspatori per chirurgia massilofaciale



Rugines – Décolleurs pour la chirurgie maxillo-faciale
 Periosteal elevators for maxillo-facial surgery
 Periostótomos para la cirugía maxilofacial
 Raspatori per chirurgia massilofaciale



Obwegeser-Freer
 210 mm – 8 1/4 "
SI-786-5-95



Obwegeser-Freer
 210 mm – 8 1/4 "
SI-786-5-96



Obwegeser
 175 mm – 7 "
SI-786-5-97



Obwegeser
 230 mm – 9 "
SI-786-5-98

Rugines – Elevateurs
Periosteal raspatories – Elevators
Raspatorios – Elevadores
Periostotomi – Elevatori



Obwegeser
180 mm – 7 "
SI-786-5-99



Obwegeser
140 mm – 5 1/2 "
SI-786-5-100



For Adults
SI-786-5-101



For Children
SI-786-5-101A



For Adults
SI-786-5-102



For Children
SI-786-5-102A



Doyen
170 mm – 6 3/4 "
Left



Doyen
170 mm – 6 3/4 "
Right

Rugines – Elevateurs
Periosteal raspatories – Elevators
Raspatorios – Elevadores
Periostotomi – Elevatori



Quervain
195 mm – 7 3/4 "
x = 6 mm
SI-786-5-103



Trelat
150 mm – 6 "
x = 8 mm
SI-786-5-104



Konig
155 mm – 6 "
x = 4.5 mm
SI-786-5-105

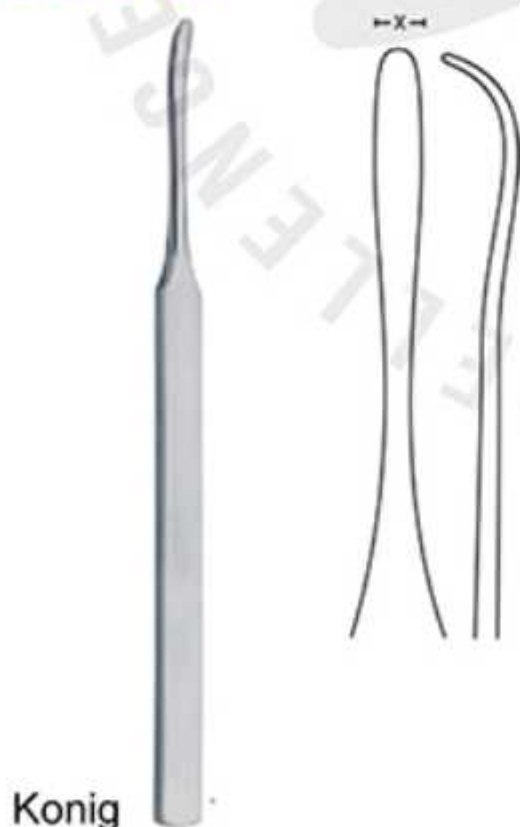

Konig
155 mm – 6 "
x = 4.5 mm
SI-786-5-106



155 mm – 6 "
SI-786-5-107

Rugines – Elevateurs
Periosteal raspatories – Elevators
Raspatorios – Elevadores
Periostotomi – Elevatori



Alderdyce
210 mm – 8 1/4"
SI-786-5-108



Mc Donald
190 mm – 7 1/2"
SI-786-5-109



Sedillot
185 mm – 7 1/4" SI-786-5-110
210 mm – 8 1/4" SI-786-5-110A



Watson-Cheyne
190 mm – 7 1/2"
SI-786-5-111

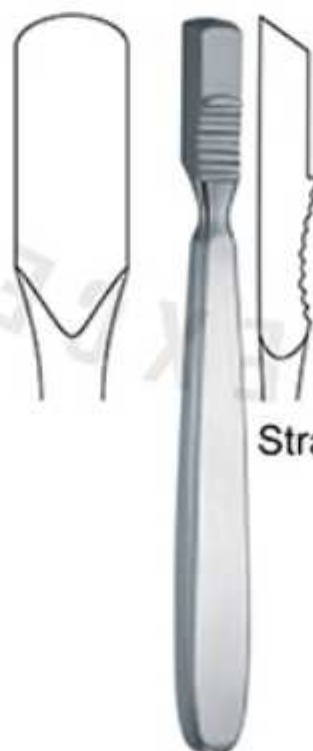

Straight

Farabeuf
150 mm – 6"
SI-786-5-112

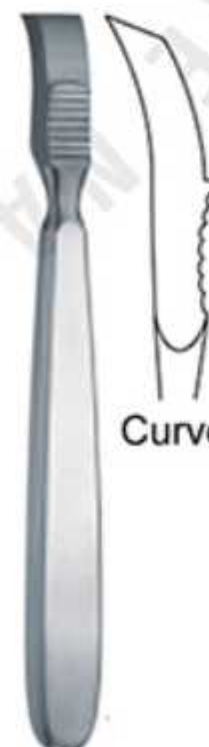

Curved

Farabeuf
150 mm – 6"
SI-786-5-112A

Rugines – Elevateurs
Periosteal raspatories – Elevators
Raspatorios – Elevadores
Periostotomi – Elevatori

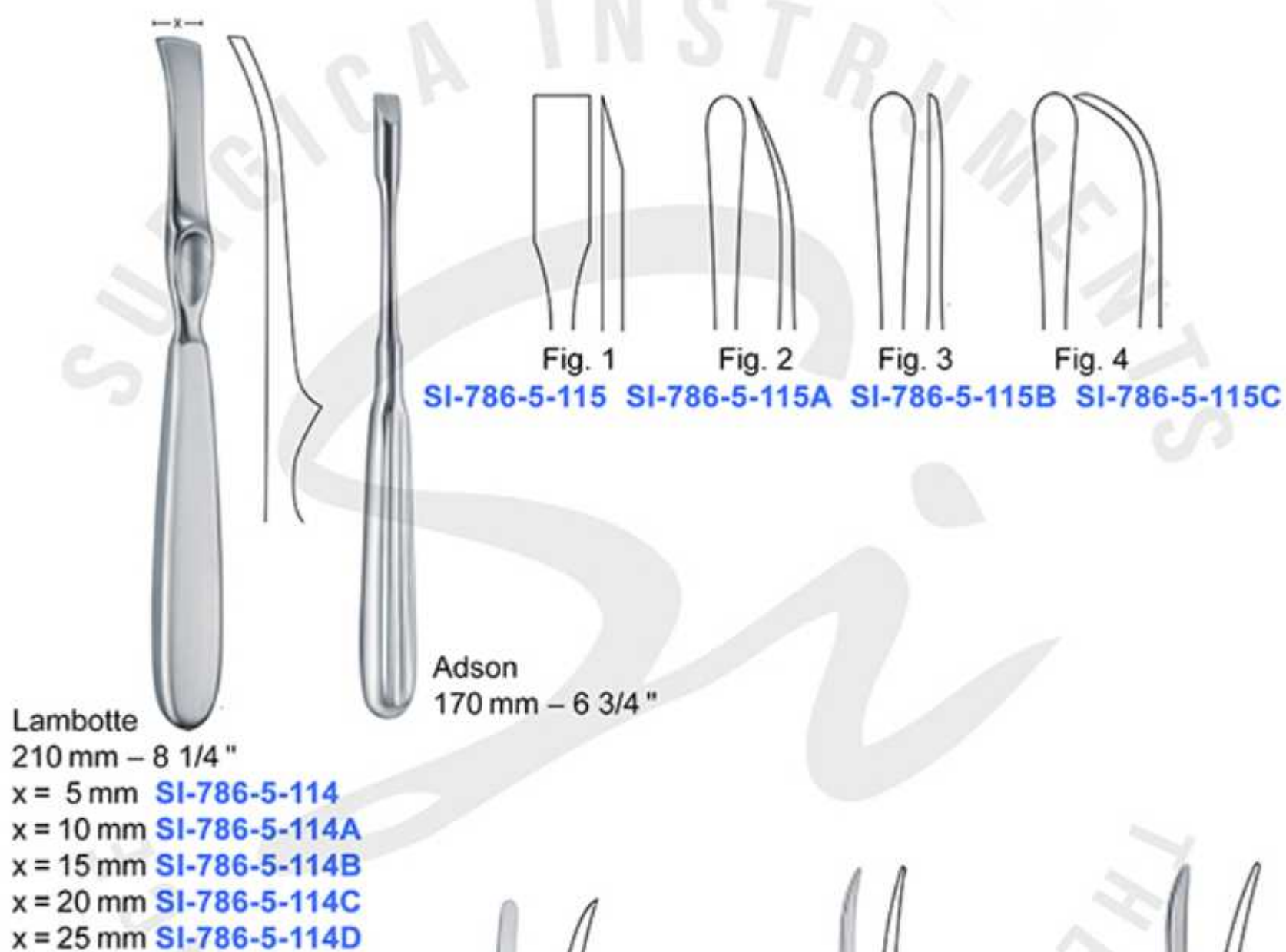

Rugines – Elevateurs
Periosteal raspatories – Elevators
Raspatorios – Elevadores
Periostotomi – Elevatori



Farabeuf-Collin
x = 11 mm
160 mm – 6 1/4 "
SI-786-5-120



Farabeuf-Collin
x = 11 mm
160 mm – 6 1/4 "
SI-786-5-121



Obwegeser
185 mm – 7 1/4 "
SI-786-5-122



Obwegeser
185 mm – 7 1/4 "
SI-786-5-123



Semb
175 mm – 7 "
12 mm
SI-786-5-124



210 mm – 8 1/4 "
12 mm
SI-786-5-125

Rugines – Elevateurs
 Periosteal raspatories – Elevators
 Raspatorios – Elevadores
 Periostotomi – Elevatori



Howarth
 215 mm – 8 1/2"
 SI-786-5-126
 Sharp/Blunt



Langenbeck
 180 mm – 7"
 SI-786-5-127



190 mm – 7 1/2"
 SI-786-5-128

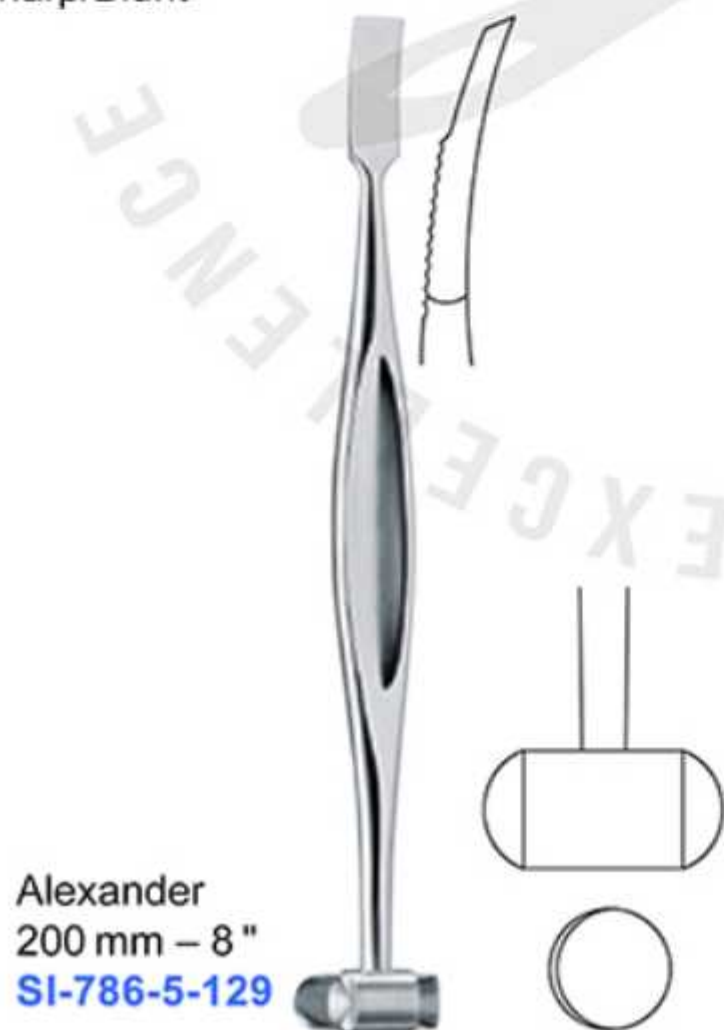

Alexander
 200 mm – 8"
 SI-786-5-129



Langenbeck
 200 mm – 8"
 x = 8 mm
 SI-786-5-130

Rugines – Elevateurs
Periosteal raspatories – Elevators
Raspatorios – Elevadores
Periostotomi – Elevatori



Langenbeck
200 mm – 8"
x = 10 mm
SI-786-5-131



Sebileau
175 mm – 7"
x = 5 mm
SI-786-5-132



175 mm – 7"
SI-786-5-133
extremely light



Martin-Langenbeck
190 mm – 7 1/2"
SI-786-5-134



Cobb
290 mm – 11 1/2"
x = 10 mm **SI-786-5-135**
x = 13 mm **SI-786-5-135A**
x = 19 mm **SI-786-5-135B**
x = 25 mm **SI-786-5-135C**
x = 32 mm **SI-786-5-135D**
x = 38 mm **SI-786-5-135E**

Aluminium Handle
Spinal Raspatory

290 mm – 11 1/2"
SI-786-5-135F
SI-786-5-135G
SI-786-5-135H
SI-786-5-135I
SI-786-5-135J
SI-786-5-135K

Steel Handle

Rugines – Elevateurs
Periosteal raspatories – Elevators
Raspatorios – Elevadores
Periostotomi – Elevatori

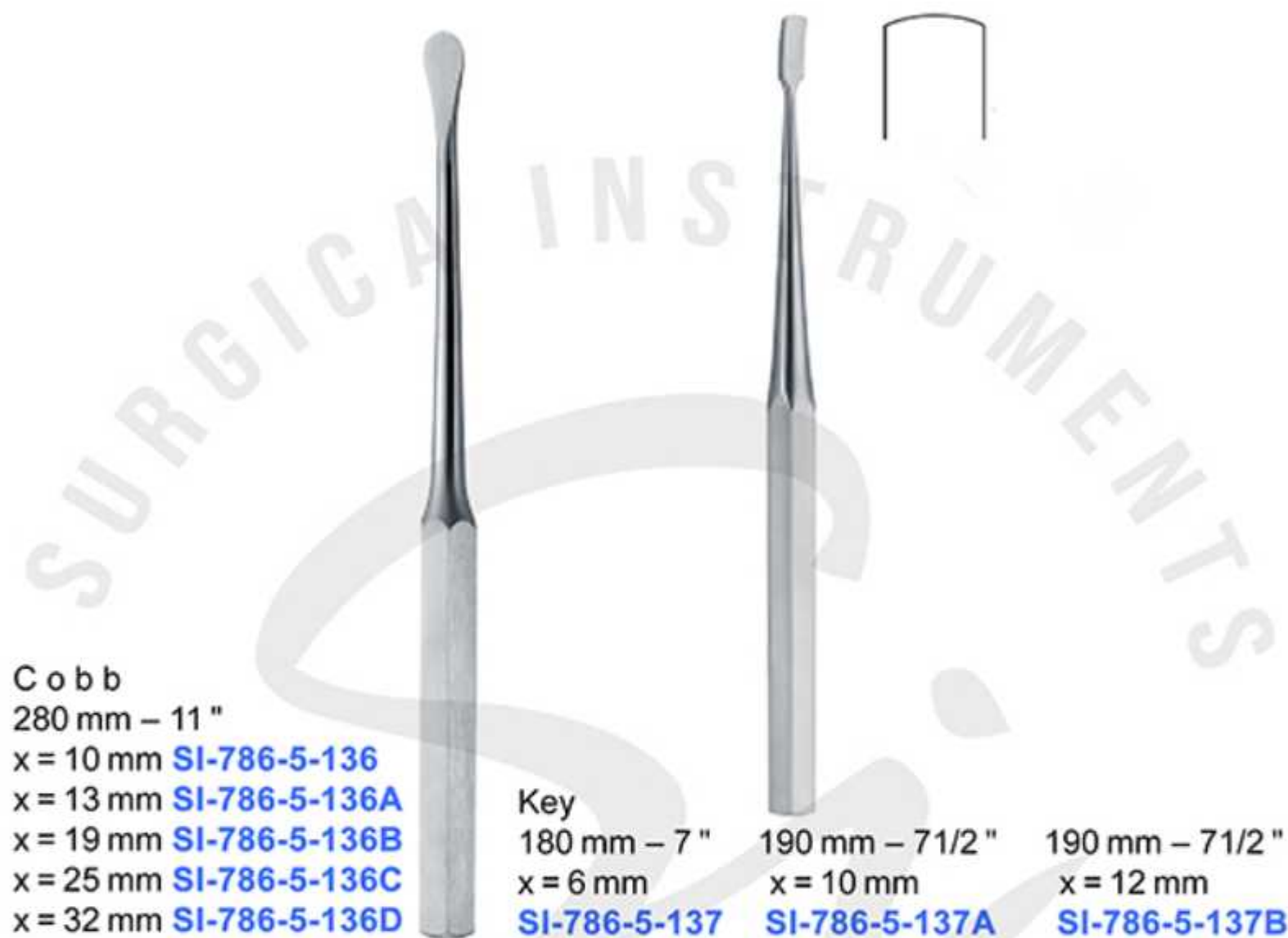

Leviers à os
Bone levers
Elevadores para huesos
Elevatori per ossa



Leviers à os
Bone levers
Elevadores para huesos
Elevatori per ossa



Leviers à os
Bone levers
Elevadores para huesos
Elevatori per ossa



Hohmann
260 mm
x = 22 mm
SI-786-5-150



Mini-Hohmann
160 mm – 6 1/4"
6 mm
SI-786-5-151



Bone levers
140 mm–5 1/2"
2.8 mm
SI-786-5-152



Bristow
230 mm – 9"
SI-786-5-153

Leviers à os
Bone levers
Elevadores para huesos
Elevatori per ossa



Lane
210 mm – 8 1/4"
SI-786-5-154



Bone Lever
150 mm – 6"
x = 15 mm
SI-786-5-155



Bone Lever
160 mm – 6 1/4"
x = 16 mm
SI-786-5-156



Bone Lever
160 mm – 6 1/4"
x = 15 mm
SI-786-5-157

Leviers à os
Bone levers
Elevadores para huesos
Elevatori per ossa



Shoulder
32 x 81 mm **SI-786-5-158**
38 x 81 mm **SI-786-5-158A**



Fukuda
x = 32 mm **SI-786-5-159**
x = 40 mm **SI-786-5-159A**



Fukuda
x = 35 mm
SI-786-5-160

Leviers à os
Bone levers
Elevadores para huesos
Elevatori per ossa



Cobra
260 mm – 10¼"
266 mm – 10½"

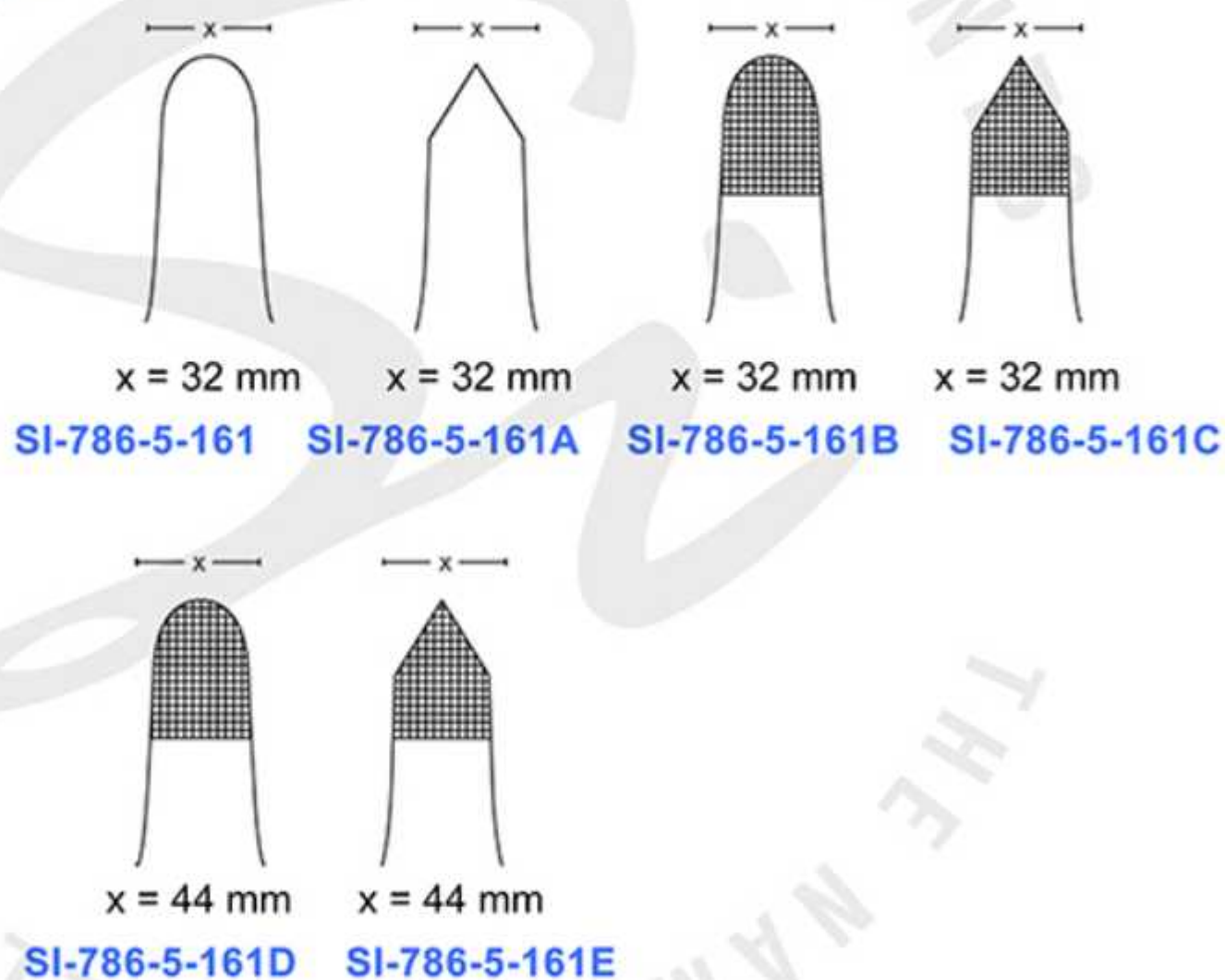

Leviers à os
Bone levers
Elevadores para huesos
Elevatori per ossa



Chandler
180 mm – 7" x = 13 mm **SI-786-5-162**
200 mm – 8" x = 19 mm **SI-786-5-162A**
230 mm – 9" x = 25 mm **SI-786-5-162B**
250 mm – 9¾" x = 32 mm **SI-786-5-162C**



Bennett
240 mm – 9 1/2"
x = 43 mm **SI-786-5-163**
x = 60 mm **SI-786-5-163A**



Murphy-Lane
300 mm – 12"
SI-786-5-164
Luxation lever

Leviers à os
Bone levers
Elevadores para huesos
Elevatori per ossa



Blount
260 mm – 10 1/4"
x = 38 mm
SI-786-5-165



Blount
260 mm – 10 1/4"
x = 42 mm
SI-786-5-166



Lange-Hohmann mod.
265 mm – 10 1/2" x = 30 mm **SI-786-5-167**
280 mm – 11" x = 33 mm **SI-786-5-167A**

Leviers à os
Bone levers
Elevadores para huesos
Elevatori per ossa

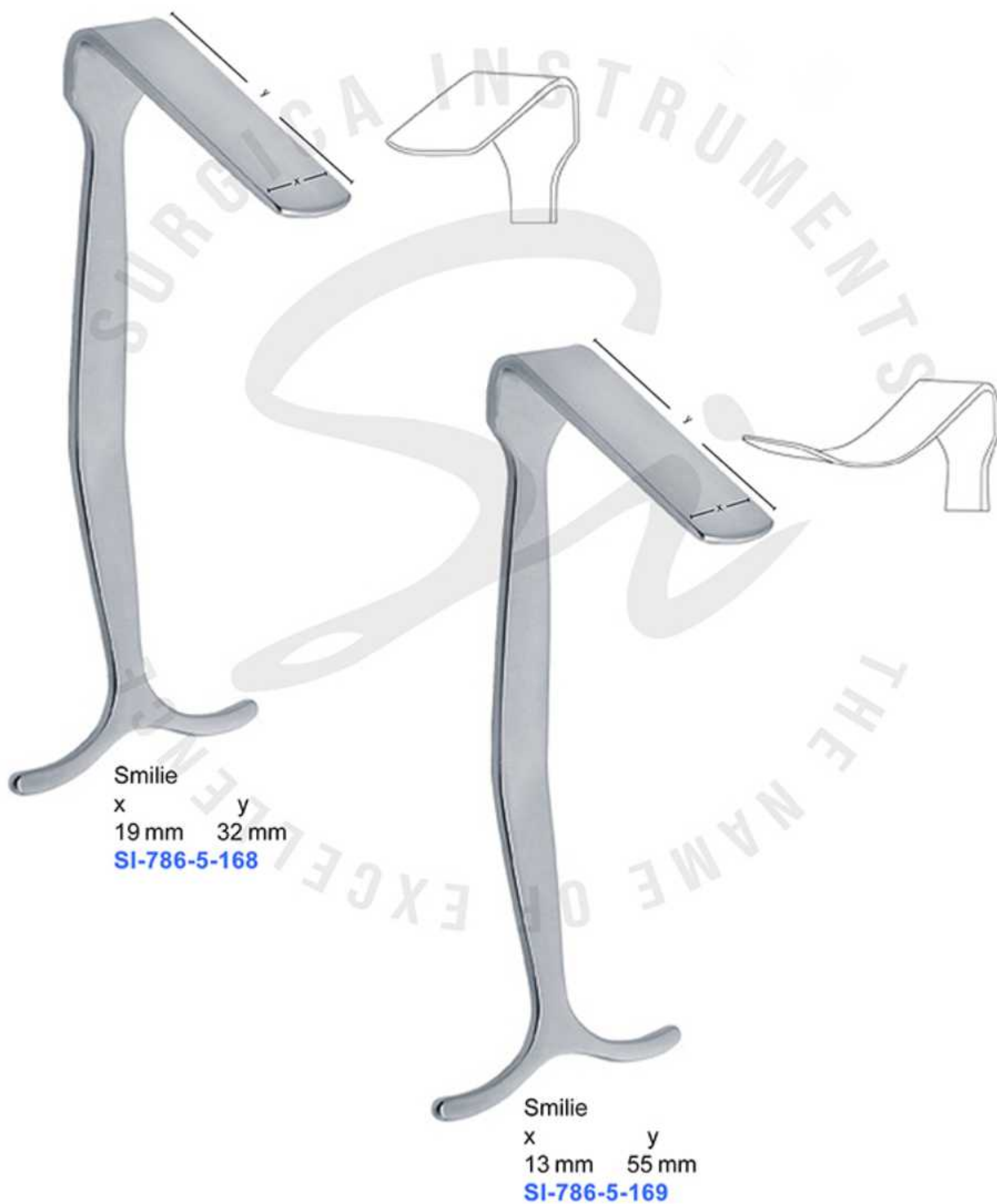

Leviers à os
Bone levers
Elevadores para huesos
Elevatori per ossa



Hohmann-Williger
160 mm – 6 1/4 "
SI-786-5-170

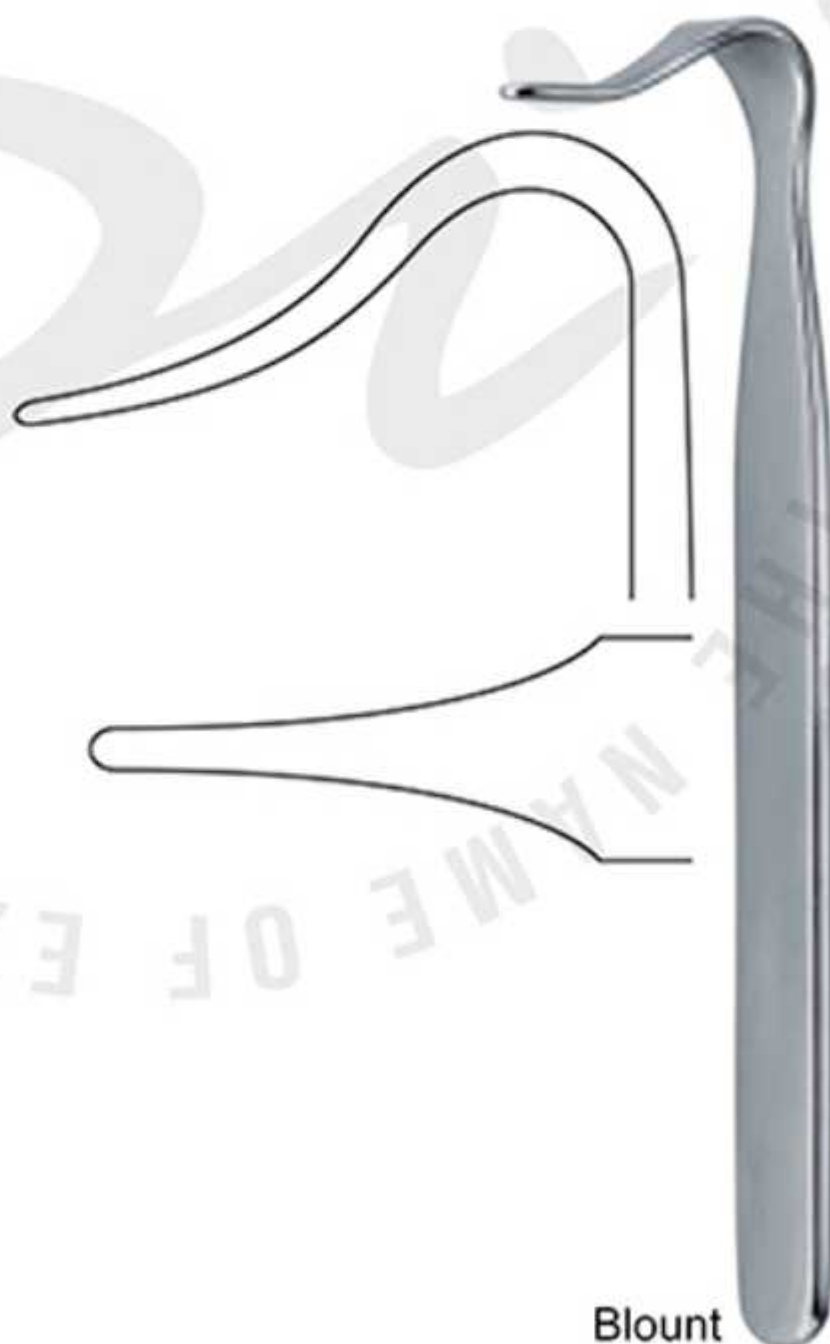

Blount
175 mm – 7 "
SI-786-5-171

Pinces gouges
Bone rongeurs
Pinzas gubias
Pinze sgorbie



Luer
Fig. 1
150 mm – 6"
SI-786-5-172



Luer
Fig. 2
150 mm – 6"
SI-786-5-173



Luer
170 mm – 6 3/4"
SI-786-5-174



Luer
170 mm – 6 3/4"
SI-786-5-175

Pinces gouges
Bone rongeurs
Pinzas gubias
Pinze sgorbie



Mini-Friedmann
120 mm – 4 3/4 "
SI-786-5-176



Friedmann
140 mm – 5 1/2 "
SI-786-5-177



Blumenthal
Fig. 1
155 mm – 6 "
SI-786-5-178



Blumenthal
Fig. 2
155 mm – 6 "
SI-786-5-179

Pinces gouges
Bone rongeurs
Pinzas gubias
Pinze sgorbie



Blumenthal
Fig. 3
155 mm – 6"
SI-786-5-180



Jansen
Fig. 1
180 mm – 7"
SI-786-5-181



Jansen
Fig. 2
180 mm – 7"
SI-786-5-182



Jansen
190 mm – 7 1/2"
SI-786-5-183

Pinces gouges
Bone rongeurs
Pinzas gubias
Pinze sgorbie



Adson
200 mm – 8 "
SI-786-5-184



Bacon
210 mm – 8 1/4 "
SI-786-5-185



Lempert
190 mm – 7 1/2 "
SI-786-5-186



Lempert
190 mm – 7 1/2 "
SI-786-5-187

Pinces gouges
Bone rongeurs
Pinzas gubias
Pinze sgorbie



Stellbrink
175 mm – 7 "
Slightly curved
SI-786-5-188



Stellbrink
175 mm – 7 "
Strongly curved
SI-786-5-189



Olivecrona
205 mm – 8 "
SI-786-5-190



Hartmann
175 mm – 7 "
SI-786-5-191

Pinces gouges
Bone rongeurs
Pinzas gubias
Pinze sgorbie



Mead
165 mm – 6 1/2 "
SI-786-5-192



Cleveland
170 mm – 6 3/4 "
SI-786-5-193



Cleveland
140 mm – 5 1/2 "
SI-786-5-194

Pinces gouges
Bone rongeurs
Pinzas gubias
Pinze sgorbie



Bohler
150 mm – 6 "
SI-786-5-195
Straight



Bohler
150 mm – 6 "
SI-786-5-196
Curved



Zaufal-Jansen
180 mm – 7 "
SI-786-5-197



Marquardt
200 mm – 8 "
SI-786-5-198

Pinces gouges
Bone rongeurs
Pinzas gubias
Pinze sgorbie



Beyer
180 mm – 7"
SI-786-5-199



Ruskin
180 mm – 7"
SI-786-5-200
Straight



Ruskin
180 mm – 7"
SI-786-5-201
Curved



Mayfield
175 mm – 7"
SI-786-5-202

Pinces gouges
Bone rongeurs
Pinzas gubias
Pinze sgorbie



Stille-Ruskin
230 mm – 9"
SI-786-5-203
Curved



Stille-Ruskin
230 mm – 9"
SI-786-5-204
Straight



Stille
230 mm – 9"
4 mm
SI-786-5-205

Pinces gouges
Bone rongeurs
Pinzas gubias
Pinze sgorbie



Stille
230 mm – 9"
6 mm
SI-786-5-206



Stille
230 mm – 9"
8 mm
SI-786-5-207



Leksell
240 mm – 9 1/2"
2 mm
SI-786-5-208

Pinces gouges
Bone rongeurs
Pinzas gubias
Pinze sgorbie



Leksell
240 mm – 9 1/2"
3 mm
SI-786-5-209



Leksell
240 mm – 9 1/2"
4 mm
SI-786-5-210



Leksell
240 mm – 9 1/2"
5 mm
SI-786-5-211

Pinces gouges
Bone rongeurs
Pinzas gubias
Pinze sgorbie



Leksell
240 mm – 9 1/2 "
6 mm
SI-786-5-212



Leksell
240 mm – 9 1/2 "
8 mm
SI-786-5-213



Echlin
230 mm – 9 "
SI-786-5-214

Pinces gouges
Bone rongeurs
Pinzas gubias
Pinze sgorbie



Pinces gouges
Bone rongeurs
Pinzas gubias
Pinze sgorbie



Rottgen-Ruskin
230 mm – 9"
SI-786-5-218



Stille-Luer
220 mm – 8 3/4"
SI-786-5-219
Straight



Stille-Luer
220 mm – 8 3/4"
SI-786-5-220
Curved

Pinces gouges
Bone rongeurs
Pinzas gubias
Pinze sgorbie



Sauerbruch
Fig. 1
300 mm – 12"
SI-786-5-221



Sauerbruch
Fig. 2
300 mm – 12"
SI-786-5-222

Pinces gouges
Bone rongeurs
Pinzas gubias
Pinze sgorbie



Luer-Stille
270 mm – 10 3/4 "
SI-786-5-223
Straight



Luer-Stille
270 mm – 10 3/4 "
SI-786-5-224
Curved

Pinces coupantes à os
Bone cutting forceps
Pinzas cortantes para huesos
Cesoie per ossa



Cottle-Kazanjian
190 mm – 7 1/2"
SI-786-5-225



Liston
140 mm – 5 1/2" **SI-786-5-226**
170 mm – 6 3/4" **SI-786-5-226A**
190 mm – 7 1/2" **SI-786-5-226B**
220 mm – 8 3/4" **SI-786-5-226C**
Straight



Liston
140 mm – 5 1/2" **SI-786-5-227**
170 mm – 6 3/4" **SI-786-5-227A**
190 mm – 7 1/2" **SI-786-5-227B**
220 mm – 8 3/4" **SI-786-5-227C**
Curved

Pinces coupantes à os
Bone cutting forceps
Pinzas cortantes para huesos
Cesoie per ossa



Bohler
150 mm – 6"
SI-786-5-228
Right



Bohler
150 mm – 6"
SI-786-5-229
Left



Ruskin-Liston
185 mm – 7 1/4"
SI-786-5-230
Straight



Ruskin-Liston
185 mm – 7 1/4"
SI-786-5-231
Curved

Pinces coupantes à os
Bone cutting forceps
Pinzas cortantes para huesos
Cesoie per ossa



Stille-Liston
270 mm – 10 3/4"
SI-786-5-232
Straight



Stille-Liston
270 mm – 10 3/4"
SI-786-5-233
Curved

Pinces coupantes à os
Bone cutting forceps
Pinzas cortantes para huesos
Cesoie per ossa



Stille-Liston
270 mm – 10 3/4 "
SI-786-5-234
Angular

Liston-Key Horsley
270 mm – 10 3/4 "
SI-786-5-236

Semb
240 mm – 9 1/2 "
SI-786-5-235

Daviers porte-os – Pincas de reposition
Bone holding forceps – Reposition forceps
Pinzas para huesos – Pinzas para reposición
Tenaglie per ossa – Pinze per riposizioni



Bone holding forcep
135 mm – 5 1/4 "
SI-786-5-237



Lewin
175 mm – 7 "
SI-786-5-238



Bone Holding Forcep
140 mm – 5 1/2 "
SI-786-5-239



Fergusson
210 mm – 8 1/4 "
SI-786-5-240



Van Buren
230 mm – 9 "
SI-786-5-241

Daviers porte-os – Pincas de reposicion
Bone holding forceps – Reposition forceps
Pinzas para huesos – Pinzas para reposición
Tenaglie per ossa – Pinze per riposizioni



Langenbeck
210 mm – 8 1/4"
SI-786-5-242



Semb
190 mm – 7 1/2"
SI-786-5-243



Dingmann
190 mm – 7 1/2"
SI-786-5-244



Sequester forceps
200 mm – 8"
SI-786-5-245
Straight



Sequester forceps
200 mm – 8"
SI-786-5-246
Curved

Daviers porte-os – Pincas de reposition
Bone holding forceps – Reposition forceps
Pinzas para huesos – Pinzas para reposición
Tenaglie per ossa – Pinze per riposizioni



Farabeuf
230 mm – 9 "
260 mm – 10 1/4 "

SI-786-5-247
SI-786-5-247A



Farabeuf-Lambotte
260 mm – 10 1/4 "
SI-786-5-248

ORTHOPEDIC – BONE SURGERY

Daviers porte-os – Pincas de reposition
Bone holding forceps – Reposition forceps
Pinzas para huesos – Pinzas para reposición
Tenaglie per ossa – Pinze per riposizioni



Martin
190 mm – 7 1/2 "
SI-786-5-249



Bircher-Ganske
200 mm – 8 "
SI-786-5-250

Daviers porte-os – Pincas de reposition
Bone holding forceps – Reposition forceps
Pinzas para huesos – Pinzas para reposición
Tenaglie per ossa – Pinze per riposizioni



Lambotte
150 mm – 6"
x = 2.5 mm
SI-786-5-251
Self-centering



Lambotte
190 mm – 7 1/2"
x = 6.5 mm
SI-786-5-252
Self-centering



Lambotte
240 mm – 9 1/2"
x = 9.5 mm
SI-786-5-253
Self-centering

Daviers porte-os – Pincas de reposition
Bone holding forceps – Reposition forceps
Pinzas para huesos – Pinzas para reposición
Tenaglie per ossa – Pinze per riposizioni



Lambotte
260 mm – 10 1/4 "
x = 10.0 mm
SI-786-5-254
Self-centering

Lambotte
280 mm – 11 "
x = 11.0 mm
SI-786-5-255
Self-centering

Daviers porte-os – Pincas de reposition
Bone holding forceps – Reposition forceps
Pinzas para huesos – Pinzas para reposición
Tenaglie per ossa – Pinze per riposizioni



Verbrugge
175 mm – 7"
x = 5.0 mm
SI-786-5-256

Verbrugge
250 mm – 10"
x = 9.5 mm
SI-786-5-257

Daviers porte-os – Pincas de reposicion
Bone holding forceps – Reposition forceps
Pinzas para huesos – Pinzas para reposición
Tenaglie per ossa – Pinze per riposizioni



Verbrugge
260 mm – 10 1/4 "
x = 10.5 mm
SI-786-5-258

Verbrugge
270 mm – 10 3/4 "
x = 12.0 mm
SI-786-5-259

Daviers porte-os – Pincas de reposition
Bone holding forceps – Reposition forceps
Pinzas para huesos – Pinzas para reposición
Tenaglie per ossa – Pinze per riposizioni

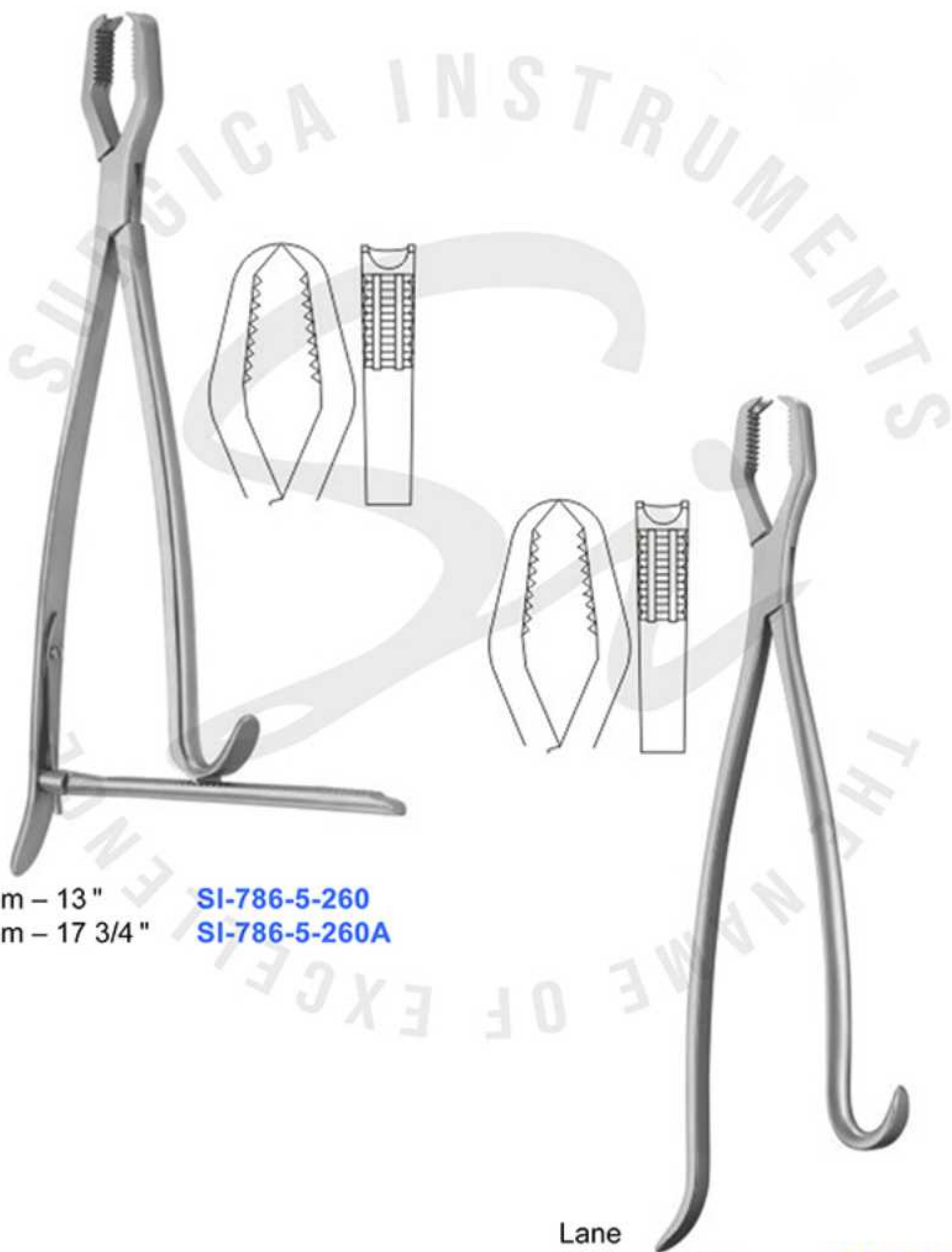

Lane
330 mm – 13"
450 mm – 17 3/4"

SI-786-5-260
SI-786-5-260A

Lane
330 mm – 13"
450 mm – 17 3/4"

SI-786-5-261
SI-786-5-261A

Daviers porte-os – Pincas de reposition
Bone holding forceps – Reposition forceps
Pinzas para huesos – Pinzas para reposición
Tenaglie per ossa – Pinze per riposizioni

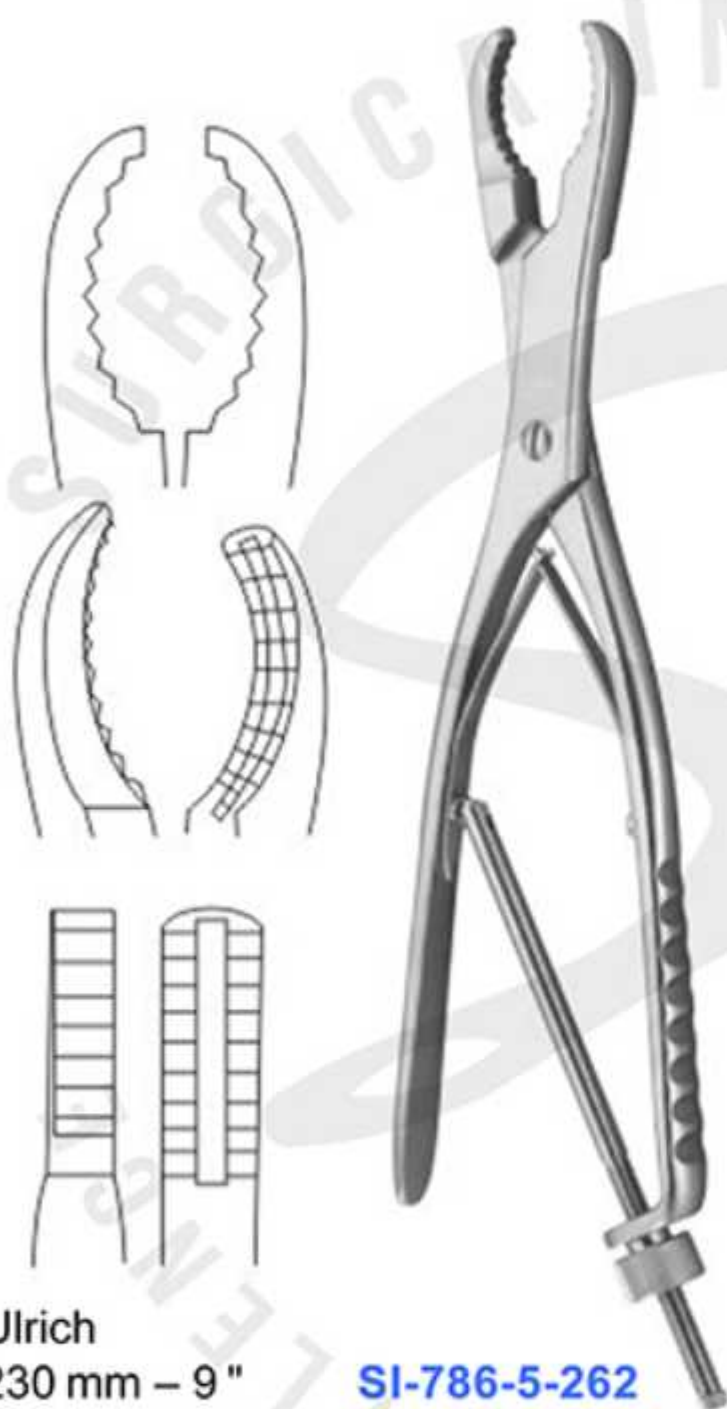

Ulrich
230 mm – 9" **SI-786-5-262**
250 mm – 9 3/4" **SI-786-5-262A**
280 mm – 11" **SI-786-5-262B**
Straight

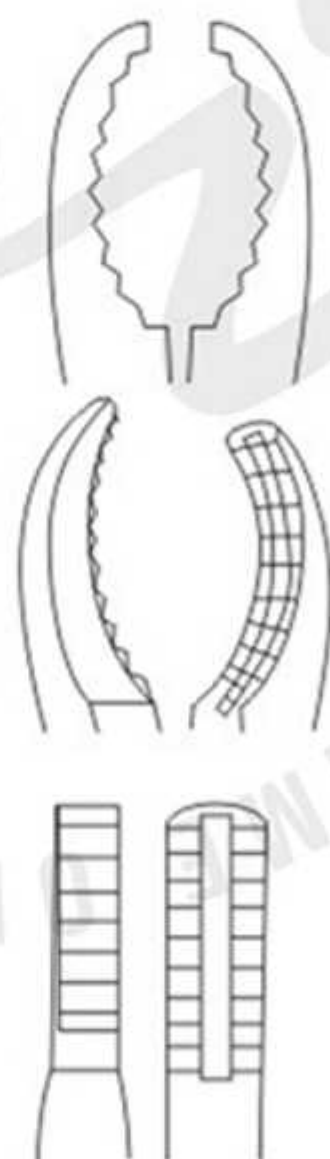

Ulrich
230 mm – 9" **SI-786-5-263**
250 mm – 9 3/4" **SI-786-5-263A**
280 mm – 11" **SI-786-5-263B**
Angular

ORTHOPEDIC – BONE SURGERY

Daviers porte-os – Pincas de reposition
Bone holding forceps – Reposition forceps
Pinzas para huesos – Pinzas para reposición
Tenaglie per ossa – Pinze per riposizioni



Lambotte
220 mm – 8 3/4 "
270 mm – 10 3/4 "
300 mm – 12 "
One jaw mobile

SI-786-5-264
SI-786-5-264A
SI-786-5-264B

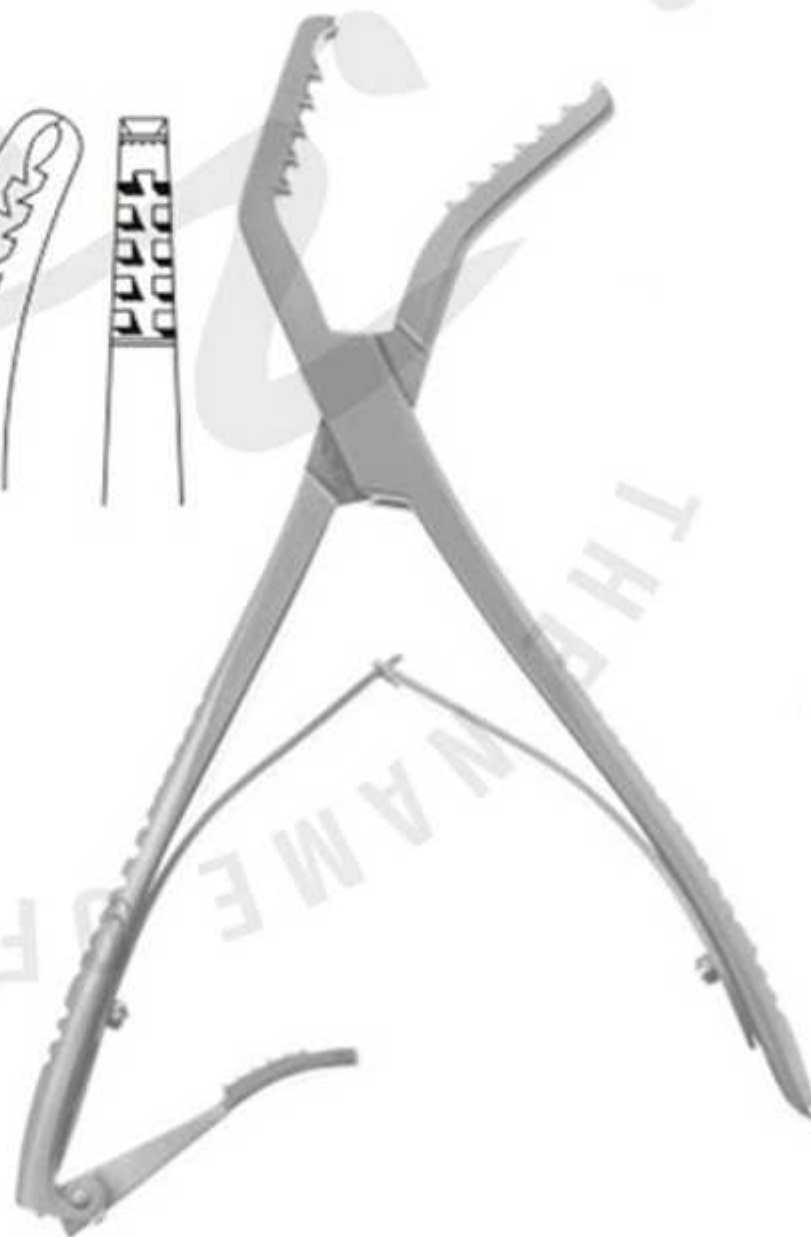

Semb
190 mm - 7 1/2 "
SI-786-5-265
Curved Sideways With Ratchet

Daviers porte-os – Pincas de reposition
Bone holding forceps – Reposition forceps
Pinzas para huesos – Pinzas para reposición
Tenaglie per ossa – Pinze per riposizioni

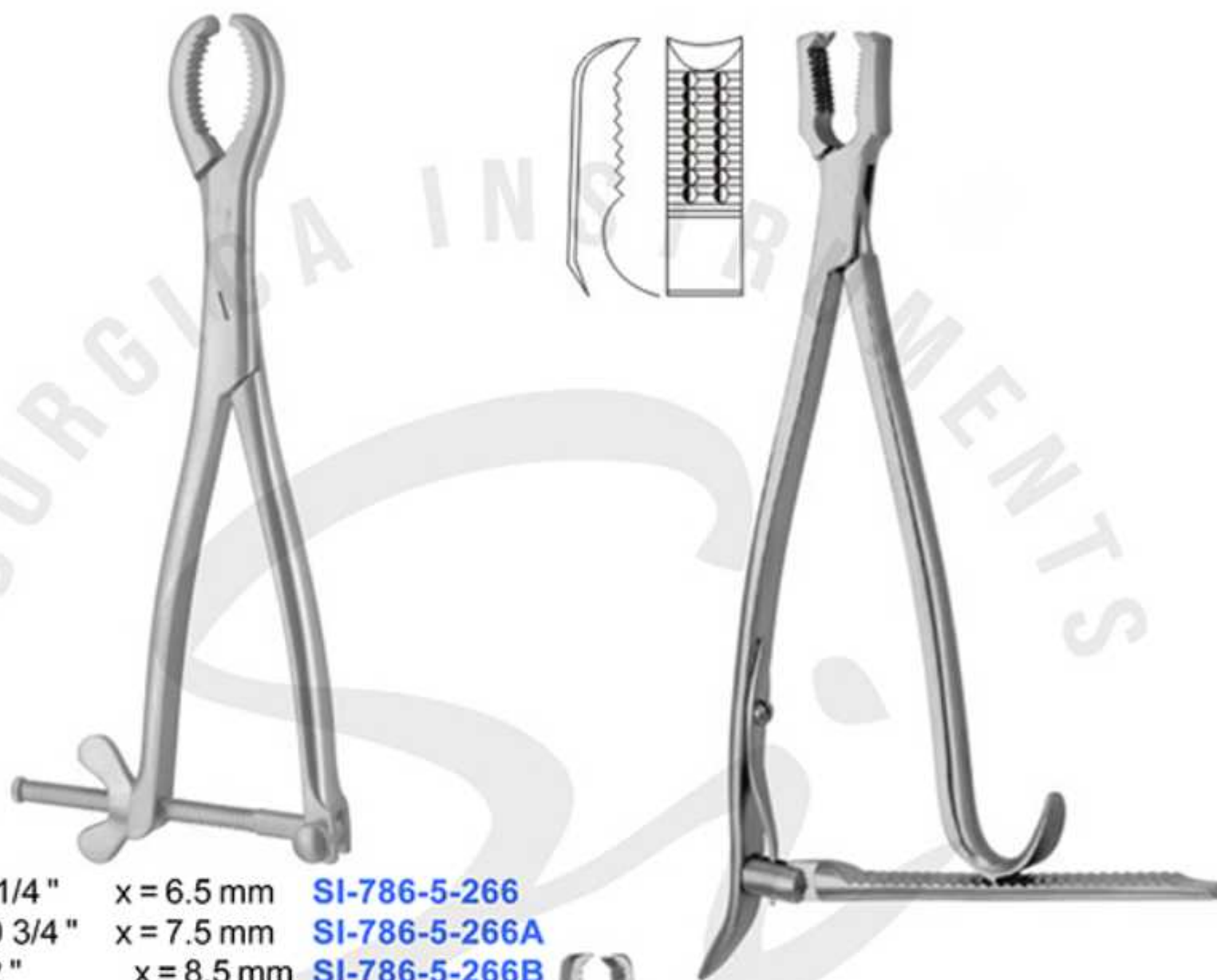

Hey Groves
210 mm – 8 1/4" x = 6.5 mm **SI-786-5-266**
270 mm – 10 3/4" x = 7.5 mm **SI-786-5-266A**
305 mm – 12" x = 8.5 mm **SI-786-5-266B**

Kern
170 mm – 6 3/4" **SI-786-5-267**
210 mm – 8 1/4" **SI-786-5-267A**

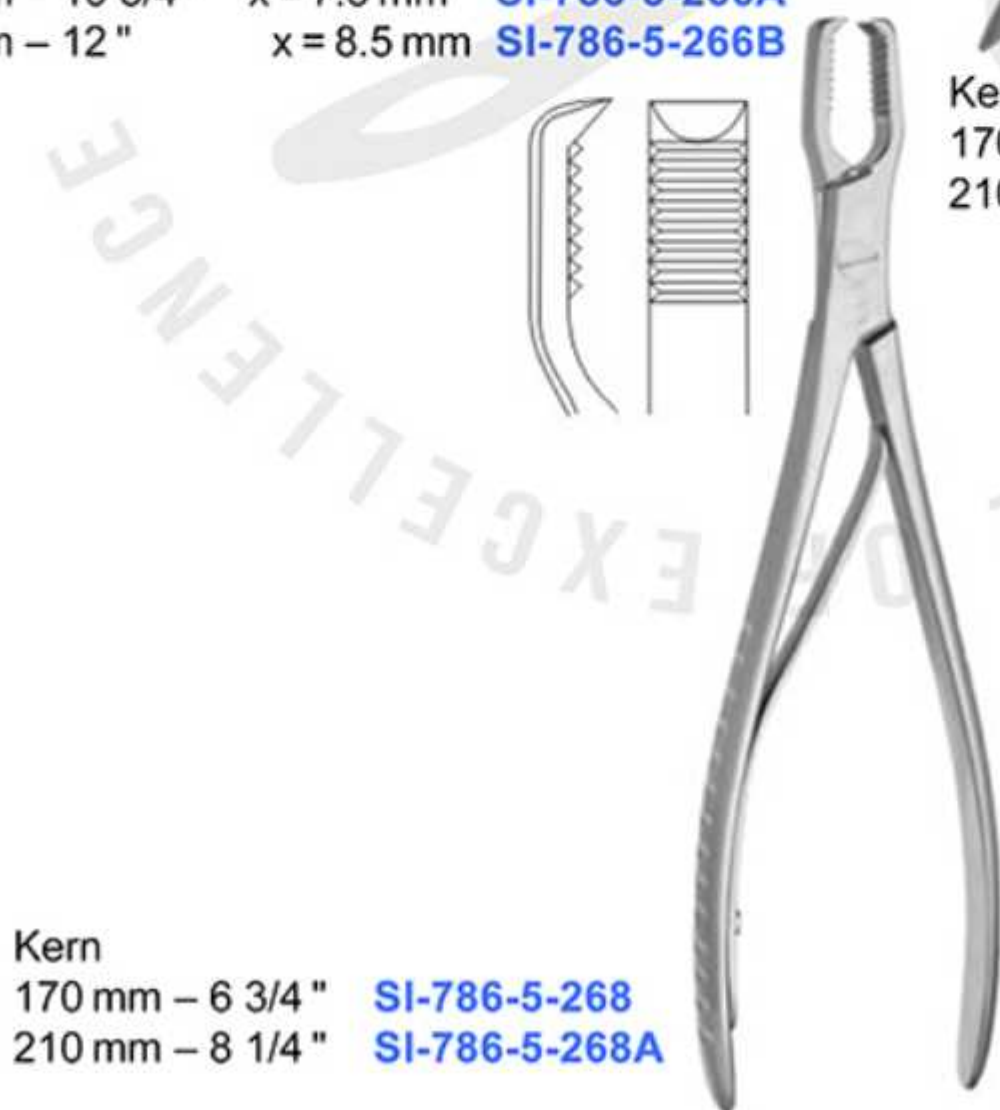

Kern
170 mm – 6 3/4" **SI-786-5-268**
210 mm – 8 1/4" **SI-786-5-268A**

Pince coupante à fil
Wire cutting forceps
Drahtschneidezange
Fórceps de corte de alambre



TC Wire cutting forceps
220 mm – 8 3/4 "
for hard wires up to 2.5mm Ø
SI-5-TC-201



TC Wire cutting forceps
220 mm – 8 3/4 "
for hard wires up to 2.2mm Ø
SI-5-TC-202

Pince coupante à fil
Wire cutting forceps
Drahtschneidezange
Fórceps de corte de alambre



TC Wire cutting forceps
230 mm – 9"
for hard wires up to 2.2mm Ø
SI-5-TC-203

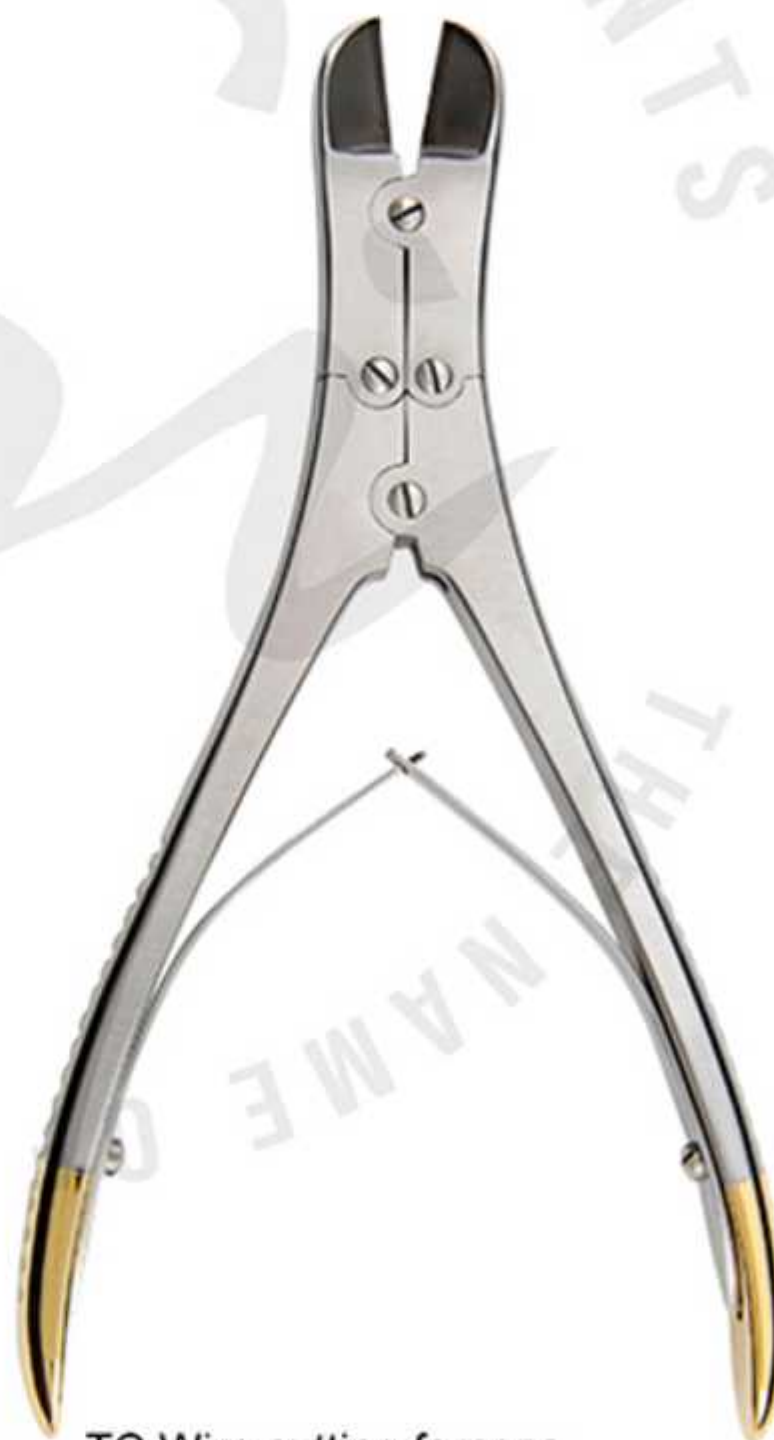

TC Wire cutting forceps
180 mm – 7"
for hard wires up to 1.5mm Ø
SI-5-TC-204

Pince coupante à fil
Wire cutting forceps
Drahtschneidezange
Fórceps de corte de alambre



TC Wire cutting forceps
150 mm – 6"
for hard wires up to 1mm Ø
SI-5-TC-206



TC Wire cutting forceps
180 mm – 7"
for hard wires up to 1.5 mm Ø
SI-5-TC-205

Pince coupante à fil
Wire cutting forceps
Drahtschneidezange
Fórceps de corte de alambre



TC Wire cutting forceps
145 mm – 5 3/4 "
for hard wires up to 1mm Ø
SI-5-TC-207



Pin Cutter Tc Inserted
570 mm – 22 1/2 " **SI-5-TC-208**
470 mm – 18 1/2 " **SI-5-TC-208A**
for Kirschner wires and
Steinmann pins up to 6mm Ø

Pince coupante à fil
Wire cutting forceps
Drahtschneidezange
Fórceps de corte de alambre



Pin Cutter Tc Inserted Heavy Duty
380 mm – 14 3/4 " **SI-5-TC-209**
560 mm – 22 " **SI-5-TC-209A**



Pin Cutter Tc Inserted Heavy Duty
470 mm – 18 1/2 " **SI-5-TC-210**
570 mm – 22 1/2 " **SI-5-TC-210A**

Pince coupante à fil
Wire cutting forceps
Drahtschneidezange
Fórceps de corte de alambre



TC Wire cutting forceps
185 cm – 7 1/4"
Wire cutting forceps for
hard wires up to 1.6mm Ø
SI-5-TC-211



TC Wire Cutting Plier
16.5 cm - 6 1/2"
For Soft Wires up to 3.5 mm Ø
For Hard Wiers up to 2.5 mm Ø
SI-5-TC-212

Pince coupante à fil
Wire cutting forceps
Drahtschneidezange
Fórceps de corte de alambre



TC Wire Cutting Plier
260 mm – 10 1/4 "
for hard wires up to 3mm Ø
SI-5-TC-213



Wire Cutting Tungsten Carbide TC
23.5cm
SI-5-TC-214

Pinces techniques
Technical forceps
Pinzas tecnicas
Pinze tecniche



Technical forceps
130 mm – 5" **SI-5-TC-215**
180 mm – 7" **SI-5-TC-215A**



Technical forceps
140 mm – 5 1/2" **SI-5-TC-216**
170 mm – 6 3/4" **SI-5-TC-216A**



Technical forceps
180 mm – 7" x = 5 mm **SI-5-TC-217**
180 mm – 7" x = 7 mm **SI-5-TC-217A**

Pinces techniques
Technical forceps
Pinzas tecnicas
Pinze tecniche



Technical forceps
170 mm – 6 3/4 "
SI-5-TC-218

Technical forceps
220 mm – 8 3/4 "
Grip forceps, combined with TC-Cutter
SI-5-TC-219

Pinces techniques
Technical forceps
Pinzas tecnicas
Pinze tecniche



Technical forceps
190 mm – 7 1/2"
Adjustable
SI-5-TC-220



Technical forceps
185 mm – 7 1/4"
Flat nose plier
SI-5-TC-221

Pinces techniques
Technical forceps
Pinzas tecnicas
Pinze tecniche



Technical forceps
180 mm – 7"
200 mm – 8"
240 mm – 9 1/2"
Locking plier

SI-5-TC-222
SI-5-TC-222A
SI-5-TC-222B



Technical forceps
185 mm – 7 1/4"
cutter, for hard wires up to 1.6mm Ø
SI-5-TC-223

Pinces techniques
Technical forceps
Pinzas tecnicas
Pinze tecniche



Technical forceps

a b c

220 mm 4,5 mm 54 mm **SI-5-TC-224**

250 mm 5,5 mm 66 mm **SI-5-TC-225**

300 mm 7,0 mm 78 mm **SI-5-TC-226**

Locking plier, only

Technical forceps

300 mm – 12"

Locking plier with holding pins

SI-5-TC-227

Technical forceps

460 mm – 18"

Locking plier with extraction device

SI-5-TC-228



Technical forceps

200 mm – 8"

Plate bending plier for plates up to 2.7mm

SI-5-TC-229

Technical forceps

240 mm – 9 1/2"

Plate bending plier for plates up to 4 mm

SI-5-TC-230

Etriers pour extension
Extension bows
Estribos para extensión
Archi per estensione



Extension bows
180 mm – 7"
Wire strainer for Kirschner wires
SI-5-TC-231

Kirschner		
x = 95 mm	y = 70 mm	SI-5-TC-232
x = 100 mm	y = 100 mm	SI-5-TC-233
x = 120 mm	y = 120 mm	SI-5-TC-234
x = 155 mm	y = 155 mm	SI-5-TC-235
x = 200 mm	y = 155 mm	SI-5-TC-236
with 3 traction hooks		

Etriers pour extension
Extension bows
Estribos para extensión
Archi per estensione



Kirschner
x = 130 mm **SI-5-TC-237**
x = 185 mm **SI-5-TC-238**
x = 220 mm **SI-5-TC-239**
with 3 traction hooks



Kirschner
x = 180 mm y = 100 mm **SI-5-TC-240**
x = 270 mm y = 160 mm **SI-5-TC-241**
with 3 traction hooks

Etriers pour extension
Extension bows
Estribos para extensión
Archi per estensione



Kirschner Bohler

x = 75 mm y = 90 mm **SI-5-TC-242**

x = 90 mm y = 160 mm **SI-5-TC-243**

x = 110 mm y = 210 mm **SI-5-TC-244**

x = 150 mm y = 210 mm **SI-5-TC-245**

Disque Intervertebral Rongeurs
Rongeurs Intervertebral Disc
Rongeurs Bandscheibe
Disco Intervertebral Rongeurs

Caspar
185 mm - 7 1/4 "

DESCRIPTION

Angled Down 2 x 12 mm
Angled Down 5 x 14 mm
Angled Up 3 x 12 mm
Angled Up 4 x 14 mm
Angled Up 2 x 12 mm



LENGTH		CODE
7 1/4 in	185 mm	SI-786-00-01
7 1/2 in	190 mm	SI-786-00-01A
7 1/2 in	190 mm	SI-786-00-01B
7 1/2 in	190 mm	SI-786-00-01C
7 1/4 in	185 mm	SI-786-00-01D

Caspar
150 mm - 6 "

DESCRIPTION

Down 3 mm
Angled Down 4 x 14 mm
Angled Up 5 x 14 mm



LENGTH		CODE
6 in	150 mm	SI-786-00-02
6 1/4 in	160 mm	SI-786-00-02A
6 1/4 in	160 mm	SI-786-00-02B

Caspar
280 mm - 11 "

DESCRIPTION

Angled Up 2 x 12 mm
Angled Up 3 x 12 mm



LENGTH		CODE
11 in	280 mm	SI-786-00-03
11 in	280 mm	SI-786-00-03A

Disque Intervertébral Rongeurs
Rongeurs Intervertebral Disc
Rongeurs Bandscheibe
Disco Intervertebral Rongeurs

Caspar

185 mm - 7 1/4 "

DESCRIPTION

Straight 2 x 12 mm
Straight 4 x 14 mm
Straight 2 x 12 mm
Down 2 x 12 mm

LENGTH

7 1/4 in 185 mm
7 1/4 in 185 mm
9 in 230 mm
9 in 230 mm

CODE

SI-786-00-04
SI-786-00-04A
SI-786-00-04B
SI-786-00-04C



Caspar IVD

160 mm - 6 1/4 "

DESCRIPTION

Straight 3 x 12 mm
Straight 5 x 12 mm

LENGTH

6 1/4 in 160 mm
6 1/4 in 160 mm

CODE

SI-786-00-05
SI-786-00-05A



Caspar IVD

185 mm - 7 1/4 "

DESCRIPTION

Straight 2 x 12 mm
Straight 3 x 12 mm
Straight 4 x 12 mm
Straight 5 x 12 mm

LENGTH

7 1/4 in 185 mm
7 1/4 in 185 mm
7 1/4 in 185 mm
7 1/4 in 185 mm

CODE

SI-786-00-06
SI-786-00-06A
SI-786-00-06B
SI-786-00-06C



Disque Intervertebral Rongeurs
Rongeurs Intervertebral Disc
Rongeurs Bandscheibe
Disco Intervertebral Rongeurs



Cushing
1.5 x 10 mm
DESCRIPTION



DESCRIPTION	LENGTH	CODE
Straight	7 in 178 mm	SI-786-00-08
Straight, 1.5 mm	9 in 230 mm	SI-786-00-08A
Down, 1.5 mm	7 in 178 mm	SI-786-00-08B
Up, 1.5 mm	7 in 178 mm	SI-786-00-08C
Up, 1.5 mm	9 in 230 mm	SI-786-00-08D

Cushing Intervertebral Disc Rongeur Straight
DESCRIPTION



DESCRIPTION	LENGTH	CODE
(1) Cup Shaped Jaws, 2 x 10 mm Cup	5 in 127 mm	SI-786-00-09
(2) Cup Shaped Jaws, 2 x 10 mm Cup	6 in 152 mm	SI-786-00-09A
(3) Cup Shaped Jaws, 2 x 10 mm Cup	7 in 178 mm	SI-786-00-09B
(4) 2 x 10 mm	6 in 155 mm	SI-786-00-09C
(5) 2 x 10 mm	7 in 175 mm	SI-786-00-09D
(6) 2 x 10 mm	9 in 230 mm	SI-786-00-09E
(7) 2 x 10 mm	10 in 250 mm	SI-786-00-09F
(8) 2 x 10 mm	12 in 305 mm	SI-786-00-09G
(9) 2 x 10 mm Jaws,with Teeth	7 in 178 mm	SI-786-00-09H

Disque Intervertebral Rongeurs
Rongeurs Intervertebral Disc
Rongeurs Bandscheibe
Disco Intervertebral Rongeurs

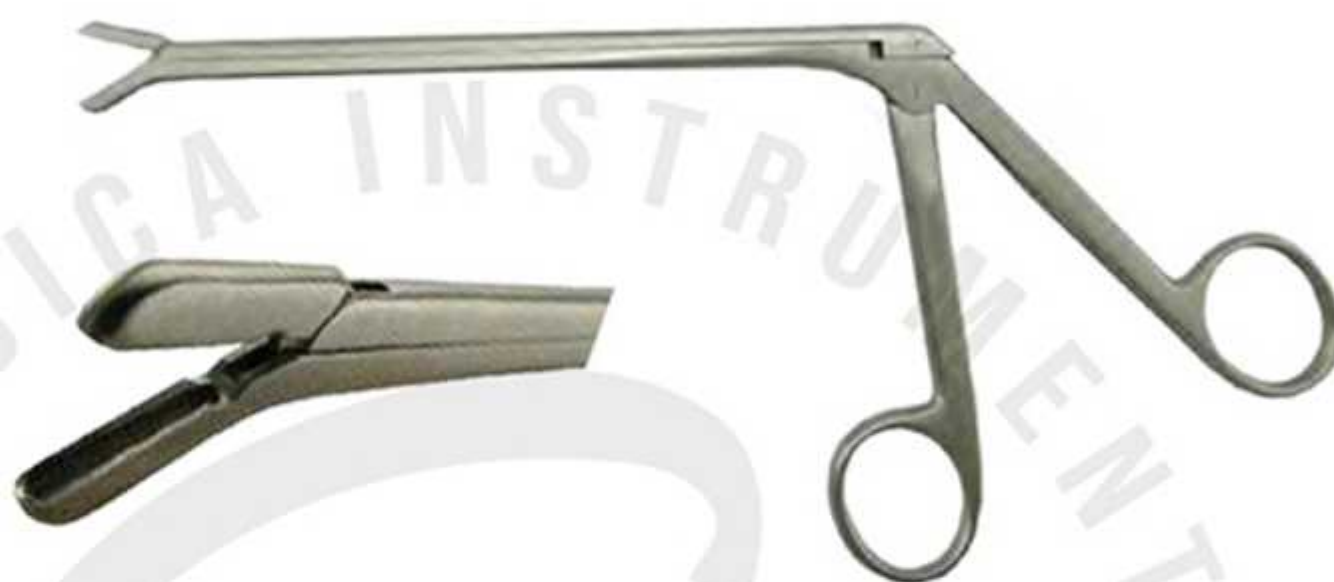

Cushing
Curved Down
DESCRIPTION

Cup Shaped Jaws, 2 x 10 mm Cup
Cup Shaped Jaws, 2 x 10 mm Cup
Cup Shaped Jaws, 2 x 10 mm Cup

LENGTH
5 in 127 mm
6 in 152 mm
7 in 178 mm

CODE
SI-786-00-10
SI-786-00-10A
SI-786-00-10B



Cushing
Curved Up
DESCRIPTION

Cup Shaped Jaws, 2 x 10 mm Cup
Cup Shaped Jaws, 2 x 10 mm Cup
Cup Shaped Jaws, 2 x 10 mm Cup

LENGTH
5 in 127 mm
6 in 152 mm
7 in 178 mm

CODE
SI-786-00-11
SI-786-00-11A
SI-786-00-11B

Disque Intervertebral Rongeurs
Rongeurs Intervertebral Disc
Rongeurs Bandscheibe
Disco Intervertebral Rongeurs

Cushing
Angled Down
DESCRIPTION

2 x 10 mm
2 x 10 mm
2 x 10 mm
2 x 10 mm Jaws,with Teeth

LENGTH
5 in 125 mm
7 in 178 mm
9 in 230 mm
7 in 178 mm

CODE
SI-786-00-12
SI-786-00-12A
SI-786-00-12B
SI-786-00-12C



Cushing
Angled Up
DESCRIPTION

2 x 10 mm
2 x 10 mm
2 x 10 mm
2 x 10 mm
2 x 10 mm Jaws,with Teeth

LENGTH
6 in 150 mm
7 in 178 mm
9 in 230 mm
11 in 280 mm
7 in 178mm

CODE
SI-786-00-13
SI-786-00-13A
SI-786-00-13B
SI-786-00-13C
SI-786-00-13D



Disque Intervertebral Rongeurs
Rongeurs Intervertebral Disc
Rongeurs Bandscheibe
Disco Intervertebral Rongeurs

Decker
1.5 x 5 mm Cups
DESCRIPTION
Straight
Angled Down
Angled Up

LENGTH
5 1/2 in 140 mm
5 1/2 in 140 mm
5 1/2 in 140 mm

CODE
SI-786-00-14
SI-786-00-14A
SI-786-00-14B



Delicate
DESCRIPTION
Straight, Cup 3 x 10 mm
Straight, 3 x 10 mm
Straight, 4 x 10 mm
Curved Down, Cup 3 x 10 mm
Curved Up, Cup 3 x 10 mm
30 Degree Up Bite, 3 x 10 mm
30 Degree Up Bite, 4 x 10 mm

LENGTH
6 in 152 mm
11 in 280 mm
11 in 280 mm
6 in 152 mm
6 in 152 mm
11 in 280 mm
11 in 280 mm

CODE
SI-786-00-15
SI-786-00-15A
SI-786-00-15B
SI-786-00-15C
SI-786-00-15D
SI-786-00-15E
SI-786-00-15F

Disque Intervertébral Rongeurs
Rongeurs Intervertebral Disc
Rongeurs Bandscheibe
Disco Intervertebral Rongeurs

Ferris-Smith
Straight
DESCRIPTION

DESCRIPTION	LENGTH	CODE
Cup 2 x 10 mm	7 in 178 mm	SI-786-00-16
Cup 3 x 10 mm	7 in 178 mm	SI-786-00-16A
Cup 4 x 10 mm	7 in 178 mm	SI-786-00-16B
Cup 3 x 10 mm	11 in 280 mm	SI-786-00-16C
Cup 6 x 10 mm	11 in 280 mm	SI-786-00-16D



Ferris-Smith
Angled Down
2 x 10 mm
7 in 178 mm
SI-786-00-17

Ferris-Smith
Angled Up
DESCRIPTION

DESCRIPTION	LENGTH	CODE
2 x 10 mm	7 in 178 mm	SI-786-00-18
4 x 10 mm	7 in 178 mm	SI-786-00-18A



Disque Intervertébral Rongeurs
Rongeurs Intervertebral Disc
Rongeurs Bandscheibe
Disco Intervertebral Rongeurs

Ferris-Smith
Curved Down
DESCRIPTION
Cup 2 x 10 mm
Cup 3 x 10 mm
Cup 4 x 10 mm

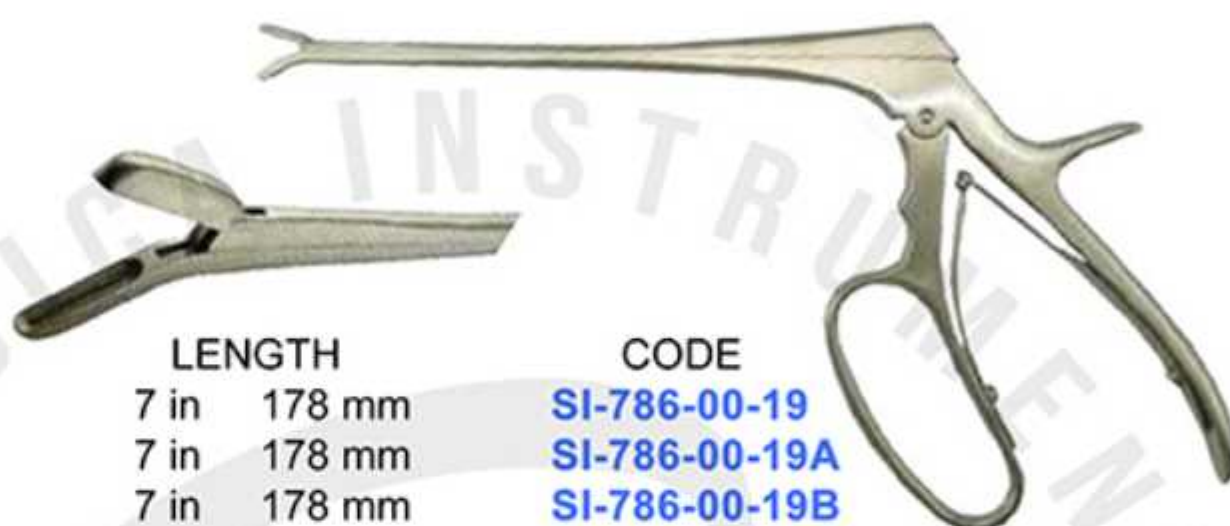

LENGTH

7 in 178 mm
7 in 178 mm
7 in 178 mm

CODE

SI-786-00-19
SI-786-00-19A
SI-786-00-19B

Ferris-Smith
Curved Up
DESCRIPTION
Cup 2 x 10 mm
Cup 3 x 10 mm
Cup 4 x 10 mm



LENGTH

7 in 178 mm
7 in 178 mm
7 in 178 mm

CODE

SI-786-00-20
SI-786-00-20A
SI-786-00-20B

Hoer
Fenestrated 140 mm
DESCRIPTION
Straight, 4 mm Jaw, 1 x 2 Teeth
Fenestrated Jaws, Cup 4 x 12 mm



LENGTH

5 1/2 in 140 mm
5 1/2 in 140 mm

CODE

SI-786-00-21
SI-786-00-21A

Disque Intervertébral Rongeurs
Rongeurs Intervertebral Disc
Rongeurs Bandscheibe
Disco Intervertebral Rongeurs

Intervertebral Disc Rongeur

DESCRIPTION	LENGTH	CODE
Straight	6 in 152 mm	SI-786-00-22
Curved Down	6 in 152 mm	SI-786-00-22A
Curved Up	6 in 152 mm	SI-786-00-22B



Intervertebral Disc Rongeur

CUP SIZE	LENGTH	CODE
4 x 8 mm	7 in 178 mm	SI-786-00-23
6 x 10 mm	7 in 178 mm	SI-786-00-23A
6 x 12 mm	7 in 178 mm	SI-786-00-23B

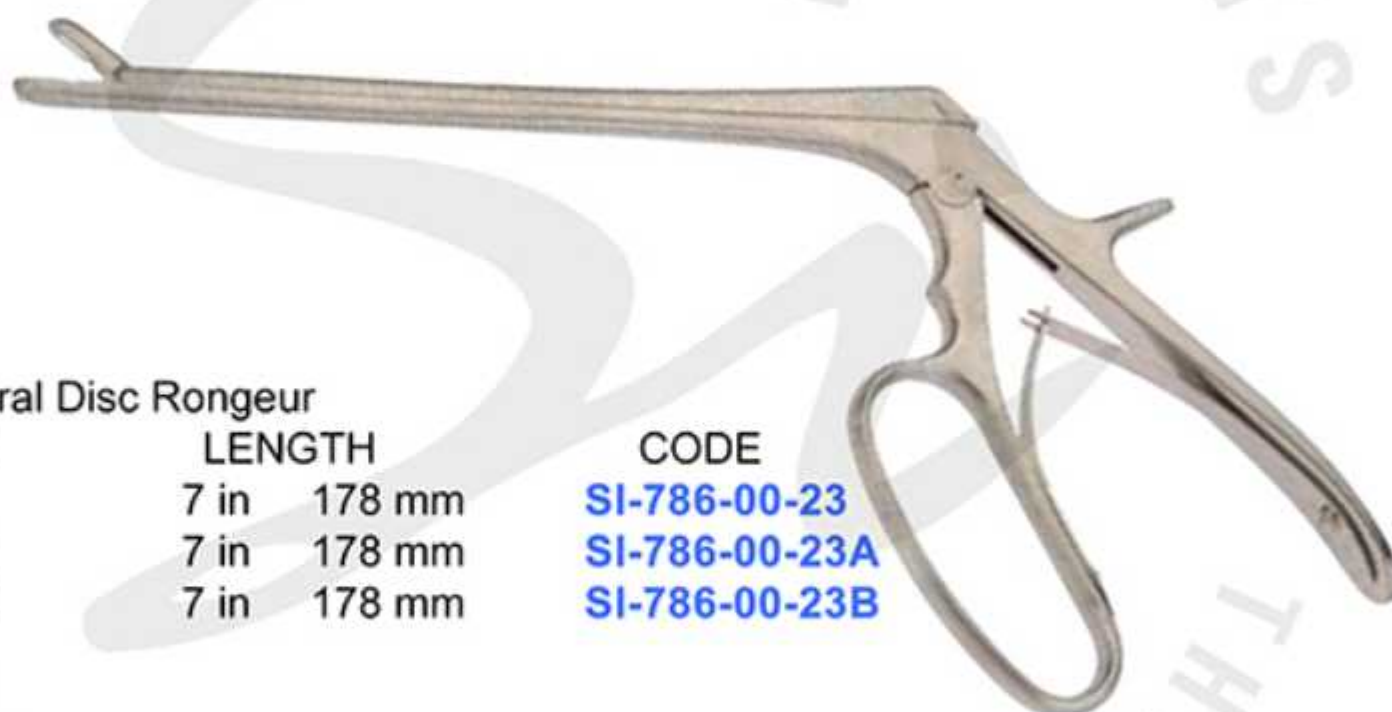

Love-Gruenwald
Curved Up

DESCRIPTION	LENGTH	CODE
Cup Shaped Jaw, 3 x 10 mm	5 in 127 mm	SI-786-00-24
Cup Shaped Jaw, 3 x 10 mm	6 in 152 mm	SI-786-00-24A
Cup Shaped Jaw, 3 x 10 mm	7 in 178 mm	SI-786-00-24B



Disque Intervertebral Rongeurs
Rongeurs Intervertebral Disc
Rongeurs Bandscheibe
Disco Intervertebral Rongeurs



Love-Gruenwald
Straight

DESCRIPTION

Cup Shaped Jaw, 3 x 10 mm
Cup Shaped Jaw, 3 x 10 mm
Cup Shaped Jaw, 3 x 10 mm
3 x 10 mm
3 x 10 mm
3 x 10 mm
3 x 10 mm
3 x 10 mm
3 x 10 mm
3 x 10 mm ,with Teeth

LENGTH

5 in 127 mm
6 in 152 mm
7 in 178 mm
5 in 127 mm
7 in 178 mm
9 in 230 mm
11 in 280 mm
12 in 305 mm
7 in 178 mm

CODE

SI-786-00-25
SI-786-00-25A
SI-786-00-25B
SI-786-00-25C
SI-786-00-25D
SI-786-00-25E
SI-786-00-25F
SI-786-00-25G
SI-786-00-25H



Love-Gruenwald
Curved Down

DESCRIPTION

Cup Shaped Jaw, 3 x 10 mm
Cup Shaped Jaw, 3 x 10 mm
Cup Shaped Jaw, 3 x 10 mm

LENGTH

5 in 127 mm
6 in 152 mm
7 in 178 mm

CODE

SI-786-00-26
SI-786-00-26A
SI-786-00-26B

Disque Intervertébral Rongeurs
Rongeurs Intervertebral Disc
Rongeurs Bandscheibe
Disco Intervertebral Rongeurs

Love-Gruenwald
Angled Up

DESCRIPTION

3 x 10 mm

3 x 10 mm

3 x 10 mm

3 x 10 mm

LENGTH

5 in 125 mm

7 in 175 mm

9 in 230 mm

11 in 280 mm

CODE

SI-786-00-27

SI-786-00-27A

SI-786-00-27B

SI-786-00-27C



Love-Gruenwald
Angled Down

DESCRIPTION

3 x 10 mm

3 x 10 mm

LENGTH

5 in 125 mm

9 in 230 mm

CODE

SI-786-00-28

SI-786-00-28A



Love-Gruenwald
Angled Up

DESCRIPTION

3 x 10 mm

LENGTH

6 in 150 mm

CODE

SI-786-00-29



Disque Intervertebral Rongeurs
Rongeurs Intervertebral Disc
Rongeurs Bandscheibe
Disco Intervertebral Rongeurs

Love-Gruenwald
DESCRIPTION
Straight
30° Up

LENGTH		CODE
11 in	279 mm	SI-786-00-30
11 in	279 mm	SI-786-00-30A



Oldberg
Cup 6 mm
178 mm - 7 "
SI-786-00-31



Peapod
DESCRIPTION
Angled Up, 3 mm
Angled Up, 4 mm
Curved Up, Cup 2 x 6 mm

LENGTH		CODE
5 1/2 in	140 mm	SI-786-00-32
5 1/2 in	140 mm	SI-786-00-32A
5 1/2 in	140 mm	SI-786-00-32B



Disque Intervertébral Rongeurs
Rongeurs Intervertebral Disc
Rongeurs Bandscheibe
Disco Intervertebral Rongeurs

Schlesinger

Straight, Serrated Cup

JAWS	LENGTH	CODE
2 mm	6 in 152 mm	SI-786-00-33
3 mm	6 in 152 mm	SI-786-00-33A
4 mm	6 in 152 mm	SI-786-00-33B



Selverstone

Straight

DESCRIPTION

DESCRIPTION	LENGTH	CODE
Cup 2 x 3 mm	6 in 152 mm	SI-786-00-34
Cup 2 x 5 mm	6 in 152 mm	SI-786-00-34A



Spence

Straight

DESCRIPTION

DESCRIPTION	LENGTH	CODE
Fenestrated Jaw, Cup 3 x 10 mm	6 1/2 in 165 mm	SI-786-00-35



Williams

Discectomy

DESCRIPTION

DESCRIPTION	LENGTH	CODE
2 mm Cup	5 1/2 in 140 mm	SI-786-00-36



Rongeurs Disque Intervertebral, Spurling
Rongeurs Intervertebral Disc, Spurling
Rongeurs Bandscheibe, Spurling
Rongeurs Disco intervertebral, Spurling

Spurling IVD
Straight
DESCRIPTION

3 x 10 mm, Fenestrated Jaw

LENGTH

5 1/2 in 140 mm

CODE

SI-786-00-37



Spurling Intervertebral Disc Rongeur
Straight
DESCRIPTION

Cup 4 x 10 mm

LENGTH

5 in 127 mm

CODE

SI-786-00-38



Spurling Intervertebral Disc Rongeur
Cup 4 x 10 mm
DESCRIPTION

Straight

LENGTH

6 in 152 mm

CODE

SI-786-00-39

Straight

6 in 152 mm

SI-786-00-39A

Curved Down

6 in 152 mm

SI-786-00-39B

Curved Up

6 in 152 mm

SI-786-00-39C



Rongeurs Disque Intervertebral, Spurling
Rongeurs Intervertebral Disc, Spurling
Rongeurs Bandscheibe, Spurling
Rongeurs Disco intervertebral, Spurling



Spurling Intervertebral Disc Rongeur

Cup 4 x 10 mm

DESCRIPTION

Curved Down

Curved Up

LENGTH

7 in 178 mm

7 in 178 mm

CODE

SI-786-00-40

SI-786-00-40A



Spurling Intervertebral Disc Rongeur

4 x 10 mm Jaws, with Teeth

DESCRIPTION

Straight

Angled Down

LENGTH

7 in 175 mm

7 in 175 mm

CODE

SI-786-00-41

SI-786-00-41A



Spurling Rongeur

Angled Down

DESCRIPTION

4 x 10 mm Jaws

4 x 10 mm Jaws

LENGTH

6 in 150 mm

9 in 230 mm

CODE

SI-786-00-42

SI-786-00-42A

Rongeurs Disque Intervertebral, Spurling
Rongeurs Intervertebral Disc, Spurling
Rongeurs Bandscheibe, Spurling
Rongeurs Disco intervertebral, Spurling

Spurling Rongeur
Angled Up

DESCRIPTION

4 x 10 mm Jaws

4 x 10 mm Jaws

4 x 10 mm Jaws

LENGTH

6 in 150 mm

9 in 230 mm

11 in 280 mm

CODE

SI-786-00-43

SI-786-00-43A

SI-786-00-43B



Spurling Rongeur
Straight

JAWS

4 x 10 mm

4 x 10 mm

4 x 10 mm

4 x 10 mm

4 x 10 mm

LENGTH

5 in 125 mm

6 in 150 mm

7 in 175 mm

9 in 230 mm

12 in 300 mm

CODE

SI-786-00-44

SI-786-00-44A

SI-786-00-44B

SI-786-00-44C

SI-786-00-44D



Spurling

Straight #1

DESCRIPTION

5 x 15 mm

5 1/2 x 15 mm

6 x 15 mm

LENGTH

5 1/2 in 140 mm

5 1/2 in 140 mm

5 1/2 in 140 mm

CODE

SI-786-00-45

SI-786-00-45A

SI-786-00-45B



Rongeurs Disque Intervertebral, Spurling
Rongeurs Intervertebral Disc, Spurling
Rongeurs Bandscheibe, Spurling
Rongeurs Disco intervertebral, Spurling



Spurling Opti-Length Rongeur, IVD

Cup 4 x 10 mm

DESCRIPTION

Straight

Up

LENGTH

11 in 279 mm

11 in 279 mm

CODE

SI-786-00-46

SI-786-00-46A



Spurling Opti-Length Rongeur, IVD

Fenestrated Jaw

DESCRIPTION

Straight, 5 mm

Angled Up, 4 mm

LENGTH

7 in 178 mm

7 in 178 mm

CODE

SI-786-00-47

SI-786-00-47A



Spurling Opti-Length Rongeur, IVD

Straight

DESCRIPTION

Fenestrated Jaw

LENGTH

9 in 230 mm

CODE

SI-786-00-48

Rongeurs Kerrison
Rongeurs Kerrison
Rongeurs Kerrison
rongeurs kerrison



Ceramic Coated Micro Kerrison Rongeur
40° Down, Thin Footplate, 9 mm Opening

DESCRIPTION	LENGTH		CODE
1 mm	8 in	200 mm	SI-786-00-49
2 mm	8 in	200 mm	SI-786-00-49A
3 mm	8 in	200 mm	SI-786-00-49B
4 mm	8 in	200 mm	SI-786-00-49C
5 mm	8 in	200 mm	SI-786-00-49D



Ceramic Coated Micro Kerrison Ejector Rongeur
40° Up, with Ejector, 9 mm Opening

DESCRIPTION	LENGTH		CODE
2 mm	7 in	175 mm	SI-786-00-50
3 mm	7 in	175 mm	SI-786-00-50A
5 mm	7 in	175 mm	SI-786-00-50B



Ceramic Coated Spurling Kerrison Rongeur
40° Up, 15 mm Opening

DESCRIPTION	LENGTH		CODE
2 mm	8 in	200 mm	SI-786-00-51
3 mm	8 in	200 mm	SI-786-00-51A
4 mm	8 in	200 mm	SI-786-00-51B
5 mm	8 in	200 mm	SI-786-00-51C

Rongeurs Kerrison
Rongeurs Kerrison
Rongeurs Kerrison
rongeurs kerrison

Ceramic Coated Micro Kerrison Rongeur
40° Up, 9 mm Opening

DESCRIPTION	LENGTH	CODE
1 mm	7 in 175 mm	SI-786-00-52
2 mm	7 in 175 mm	SI-786-00-52A
3 mm	7 in 175 mm	SI-786-00-52B
4 mm	7 in 175 mm	SI-786-00-52C
5 mm	7 in 175 mm	SI-786-00-52D
6 mm	7 in 175 mm	SI-786-00-52E



Ceramic Coated Micro Kerrison Rongeur
40° Up, 9 mm Opening

DESCRIPTION	LENGTH	CODE
1 mm	8 in 200 mm	SI-786-00-53
2 mm	8 in 200 mm	SI-786-00-53A
3 mm	8 in 200 mm	SI-786-00-53B
4 mm	8 in 200 mm	SI-786-00-53C
5 mm	8 in 200 mm	SI-786-00-53D
6 mm	8 in 200 mm	SI-786-00-53E



Ceramic Coated Micro Kerrison Rongeur
40° Up, 15 mm Opening, Small Handle

DESCRIPTION	LENGTH	CODE
2 mm	8 in 200 mm	SI-786-00-54
3 mm	8 in 200 mm	SI-786-00-54A
4 mm	8 in 200 mm	SI-786-00-54B
5 mm	8 in 200 mm	SI-786-00-54C



Rongeurs Kerrison
Rongeurs Kerrison
Rongeurs Kerrison
rongeurs kerrison



Ceramic Coated Micro Kerrison Rongeur
40° Up, 9 mm Opening

DESCRIPTION	LENGTH		CODE
1 mm	9 in	230 mm	SI-786-00-55
2 mm	9 in	230 mm	SI-786-00-55A
3 mm	9 in	230 mm	SI-786-00-55B
4 mm	9 in	230 mm	SI-786-00-55C
5 mm	9 in	230 mm	SI-786-00-55D
6 mm	9 in	230 mm	SI-786-00-55E



Ceramic Coated Micro Kerrison Convertible Rongeur
40° Up, Thin Footplate

DESCRIPTION	LENGTH		CODE
1 mm	7 in	175 mm	SI-786-00-56
2 mm	7 in	175 mm	SI-786-00-56A
3 mm	7 in	175 mm	SI-786-00-56B
4 mm	7 in	175 mm	SI-786-00-56C
5 mm	7 in	175 mm	SI-786-00-56D



Ceramic Coated Micro Kerrison Convertible Rongeur
40° Up, Thin Footplate

DESCRIPTION	LENGTH		CODE
1 mm	9 in	230 mm	SI-786-00-57
2 mm	9 in	230 mm	SI-786-00-57A
3 mm	9 in	230 mm	SI-786-00-57B
4 mm	9 in	230 mm	SI-786-00-57C
5 mm	9 in	230 mm	SI-786-00-57D

Rongeurs Kerrison
Rongeurs Kerrison
Rongeurs Kerrison
rongeurs kerrison



Ceramic Coated Micro Kerrison Convertible Rongeur
40° Up, 15 mm Opening

DESCRIPTION	LENGTH	CODE
2 mm	8 in 200 mm	SI-786-00-58
3 mm	8 in 200 mm	SI-786-00-58A
4 mm	8 in 200 mm	SI-786-00-58B
5 mm	8 in 200 mm	SI-786-00-58C



Ferris Smith-Kerrison Rongeur
40° Up, 2 mm 7 in 175 mm

DESCRIPTION	LENGTH	CODE
40° Up, 2 mm	7 in 175 mm	SI-786-00-59
40° Down, 1 mm	7 in 175 mm	SI-786-00-59A
Straight, 6 x 10 mm	10 in 250 mm	SI-786-00-59B
Up Biting, 6 x 10 mm	10 in 250 mm	SI-786-00-59C



Kerrison Lumbar Rongeur 40° Up,
Hardy Style Handle with Ball Spring 178 mm

DESCRIPTION	LENGTH	CODE
3 mm	7 in 178 mm	SI-786-00-60
4 mm	7 in 178 mm	SI-786-00-60A
5 mm	7 in 178 mm	SI-786-00-60B
6 mm	7 in 178 mm	SI-786-00-60C

Rongeurs Kerrison
Rongeurs Kerrison
Rongeurs Kerrison
rongeurs kerrison

Kerrison Lumbar Rongeur 90° Down,
Hardy Style Handle with Ball Spring 178 mm

DESCRIPTION	LENGTH	CODE
3 mm	7 in 178 mm	SI-786-00-61
4 mm	7 in 178 mm	SI-786-00-61A
5 mm	7 in 178 mm	SI-786-00-61B
6 mm	7 in 178 mm	SI-786-00-61C



Kerrison Lumbar Rongeur 90° Up,
Hardy Style Handle with Ball Spring 178 mm

DESCRIPTION	LENGTH	CODE
3 mm	7 in 178 mm	SI-786-00-62
4 mm	7 in 178 mm	SI-786-00-62A
5 mm	7 in 178 mm	SI-786-00-62B
6 mm	7 in 178 mm	SI-786-00-62C



Kerrison Lumbar Rongeur 40°
Up, Hardy Style Handle with Ball Spring 203 mm

DESCRIPTION	LENGTH	CODE
3 mm	8 in 203 mm	SI-786-00-63
4 mm	8 in 203 mm	SI-786-00-63A
6 mm	8 in 203 mm	SI-786-00-63B
5 mm	8 in 203 mm	SI-786-00-63C



Rongeurs Kerrison
Rongeurs Kerrison
Rongeurs Kerrison
rongeurs kerrison

Kerrison Lumbar Rongeur
40° Up 254 mm

DESCRIPTION	LENGTH		CODE
2 mm	10 in	254 mm	SI-786-00-65
3 mm	10 in	254 mm	SI-786-00-65A
4 mm	10 in	254 mm	SI-786-00-65B
5 mm	10 in	254 mm	SI-786-00-65C



Kerrison Lumbar Rongeur 40° Up,
Hardy Style Handle with Ball Spring 279 mm

DESCRIPTION	LENGTH		CODE
3 mm	11 in	279 mm	SI-786-00-66
4 mm	11 in	279 mm	SI-786-00-66A
5 mm	11 in	279 mm	SI-786-00-66B
6 mm	11 in	279 mm	SI-786-00-66C



Kerrison Lumbar Rongeur 90° Down,
Hardy Style Handle with Ball Spring 203 mm

DESCRIPTION	LENGTH		CODE
3 mm	8 in	203 mm	SI-786-00-67
4 mm	8 in	203 mm	SI-786-00-67A
5 mm	8 in	203 mm	SI-786-00-67B
6 mm	8 in	203 mm	SI-786-00-67C



Rongeurs Kerrison
Rongeurs Kerrison
Rongeurs Kerrison
rongeurs kerrison

Micro Rongeur
40° Up, Bayonet
DESCRIPTION

2 mm
3 mm

LENGTH

2 3/4 in 70 mm
2 3/4 in 70 mm

CODE

SI-786-00-68
SI-786-00-68A



Micro Kerrison Convertible Rongeur 40° Up,
Regular Footplate, with Ejector 175 mm 7"
DESCRIPTION

3 mm
4 mm
5 mm

LENGTH

7 in 175 mm
7 in 175 mm
7 in 175 mm

CODE

SI-786-00-69
SI-786-00-69A
SI-786-00-69B



Micro Kerrison Convertible Rongeur 203 mm 8"
40° Up, Thin Footplate

DESCRIPTION

1 mm
2 mm
3 mm
4 mm
5 mm

LENGTH

8 in 203 mm
8 in 203 mm
8 in 203 mm
8 in 203 mm
8 in 203 mm

CODE

SI-786-00-70
SI-786-00-70A
SI-786-00-70B
SI-786-00-70C
SI-786-00-70D



Rongeurs Kerrison
Rongeurs Kerrison
Rongeurs Kerrison
rongeurs kerrison

Micro Kerrison Convertible Rongeur 203 mm 8"
40° Up, Regular Footplate

DESCRIPTION	LENGTH	CODE
1 mm	8 in 203 mm	SI-786-00-71
2 mm	8 in 203 mm	SI-786-00-71A
3 mm	8 in 203 mm	SI-786-00-71B
4 mm	8 in 203 mm	SI-786-00-71C
5 mm	8 in 203 mm	SI-786-00-71D



Micro Kerrison Convertible Ejector Rongeur 40° Up,
Thin Footplate, with Ejector 203 mm 8"

DESCRIPTION	LENGTH	CODE
3 mm	8 in 203 mm	SI-786-00-72
4 mm	8 in 203 mm	SI-786-00-72A
5 mm	8 in 203 mm	SI-786-00-72B



Micro Kerrison Convertible Ejector Rongeur 40° Up,
Regular Footplate, with Ejector 203 mm 8"

DESCRIPTION	LENGTH	CODE
3 mm	8 in 203 mm	SI-786-00-73
4 mm	8 in 203 mm	SI-786-00-73A
5 mm	8 in 203 mm	SI-786-00-73B



Rongeurs Kerrison
Rongeurs Kerrison
Rongeurs Kerrison
rongeurs kerrison



Micro Kerrison Convertible Rongeur 200 mm 8"
40° Up, 15 mm Opening

DESCRIPTION	LENGTH	CODE
2 mm	8 in 200 mm	SI-786-00-74
3 mm	8 in 200 mm	SI-786-00-74A
4 mm	8 in 200 mm	SI-786-00-74B
5 mm	8 in 200 mm	SI-786-00-74C



Micro Kerrison Ejector Rongeur 175 mm 7"
40° Up, with Ejector, 9 mm Opening

DESCRIPTION	LENGTH	CODE
2 mm	7 in 175 mm	SI-786-00-75
3 mm	7 in 175 mm	SI-786-00-75A
4 mm	7 in 175 mm	SI-786-00-75B
5 mm	7 in 175 mm	SI-786-00-75C
6 mm	7 in 175 mm	SI-786-00-75D



Micro Kerrison Ejector Rongeur
200 mm 8" 40°, 9 mm Opening

DESCRIPTION	LENGTH	CODE
2 mm	8 in 200 mm	SI-786-00-76
3 mm	8 in 200 mm	SI-786-00-76A
4 mm	8 in 200 mm	SI-786-00-76B
5 mm	8 in 200 mm	SI-786-00-76C
6 mm	8 in 200 mm	SI-786-00-76D

Rongeurs Kerrison
Rongeurs Kerrison
Rongeurs Kerrison
rongeurs kerrison



Micro Kerrison T-Bar Ejector Rongeur 200 mm 8"
40° Up, Thin Footplate, Small Handle, 9 mm Opening

DESCRIPTION	LENGTH	CODE
2.5 mm	8 in 200 mm	SI-786-00-77
3 mm	8 in 200 mm	SI-786-00-77A
4 mm	8 in 200 mm	SI-786-00-77B
5 mm	8 in 200 mm	SI-786-00-77C



Micro Rongeur 70 mm 2 3/4"
40° Up, Bayonet

DESCRIPTION	LENGTH	CODE
1 mm	2 3/4 in 70 mm	SI-786-00-78



Kerrison Rongeur
70° Up, Curved 200 mm

DESCRIPTION	LENGTH	CODE
2 mm	8 in 200 mm	SI-786-00-79
3 mm	8 in 200 mm	SI-786-00-79A
4 mm	8 in 200 mm	SI-786-00-79B
5 mm	8 in 200 mm	SI-786-00-79C

Rongeurs Kerrison
Rongeurs Kerrison
Rongeurs Kerrison
rongeurs kerrison

Micro Kerrison Rongeur 175 mm 7"
40° Up, Thin Footplate, 9 mm Opening

DESCRIPTION	LENGTH		CODE
1 mm	7 in	175 mm	SI-786-00-80
2 mm	7 in	175 mm	SI-786-00-80A
3 mm	7 in	175 mm	SI-786-00-80B
4 mm	7 in	175 mm	SI-786-00-80C
5 mm	7 in	175 mm	SI-786-00-80D



Micro Kerrison Bayonet Rongeur
40° Up, Ceramic 160 mm 6 1/4"

DESCRIPTION	LENGTH		CODE
1 mm	6 1/4 in	160 mm	SI-786-00-81
2 mm	6 1/4 in	160 mm	SI-786-00-81A
3 mm	6 1/4 in	160 mm	SI-786-00-81B
4 mm	6 1/4 in	160 mm	SI-786-00-81C
5 mm	6 1/4 in	160 mm	SI-786-00-81D



Micro Kerrison Bayonet Rongeur
90° Up, Ceramic 160 mm 6 1/4"

DESCRIPTION	LENGTH		CODE
1 mm	6 1/4 in	160 mm	SI-786-00-82
2 mm	6 1/4 in	160 mm	SI-786-00-82A
3 mm	6 1/4 in	160 mm	SI-786-00-82B
4 mm	6 1/4 in	160 mm	SI-786-00-82C
5 mm	6 1/4 in	160 mm	SI-786-00-82D



Rongeurs Kerrison
Rongeurs Kerrison
Rongeurs Kerrison
rongeurs kerrison

Micro Kerrison Rongeur 200 mm 8"
40° Up, Small Handle, 15 mm Opening

DESCRIPTION	LENGTH	CODE
2 mm	8 in 200 mm	SI-786-00-83
3 mm	8 in 200 mm	SI-786-00-83A
4 mm	8 in 200 mm	SI-786-00-83B
5 mm	8 in 200 mm	SI-786-00-83C



Micro Kerrison Rongeur 200 mm 8"
40° Up, Thin Footplate, 9 mm Opening

DESCRIPTION	LENGTH	CODE
1 mm	8 in 200 mm	SI-786-00-84
1.5 mm	8 in 200 mm	SI-786-00-84A
2 mm	8 in 200 mm	SI-786-00-84B
3 mm	8 in 200 mm	SI-786-00-84C
4 mm	8 in 200 mm	SI-786-00-84D
5 mm	8 in 200 mm	SI-786-00-84E
6 mm	8 in 200 mm	SI-786-00-84F

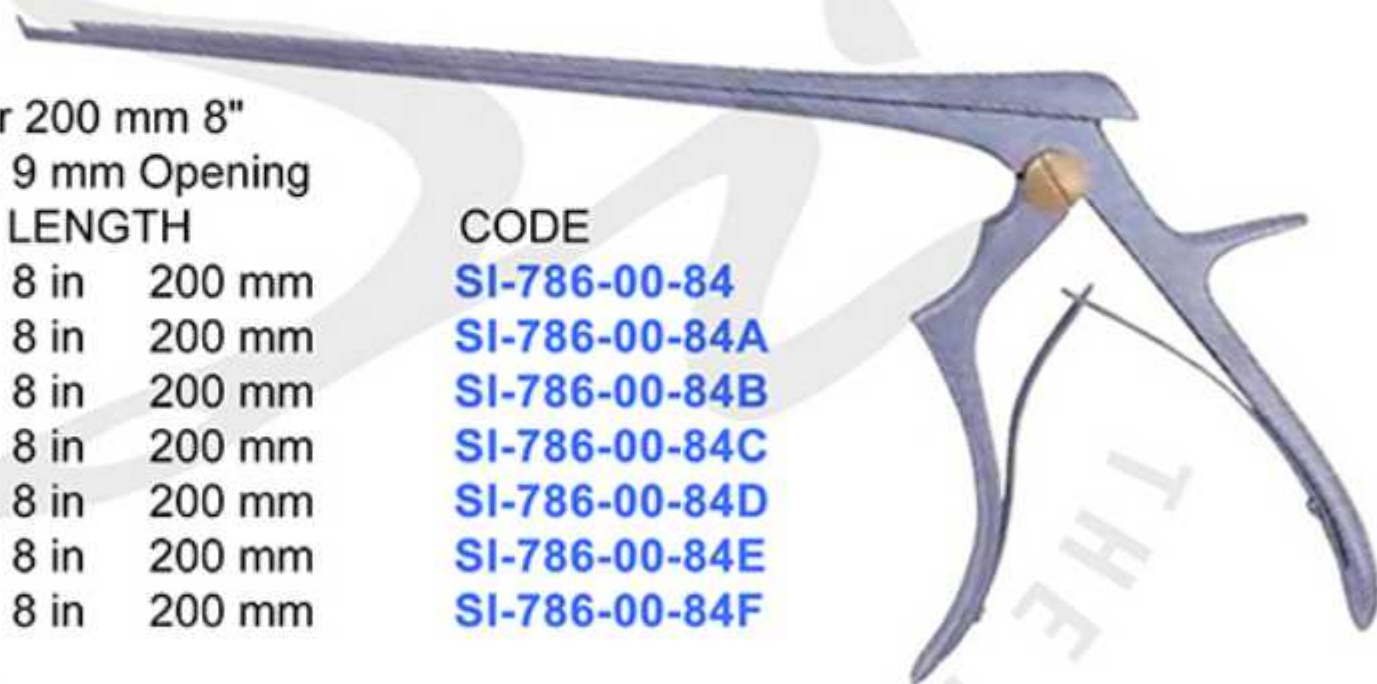

Micro Kerrison Rongeur 200 mm 8"
40° Up, Thin Footplate, 15 mm Opening

DESCRIPTION	LENGTH	CODE
2 mm	8 in 200 mm	SI-786-00-85
3 mm	8 in 200 mm	SI-786-00-85A
4 mm	8 in 200 mm	SI-786-00-85B
5 mm	8 in 200 mm	SI-786-00-85C



Rongeurs Kerrison
Rongeurs Kerrison
Rongeurs Kerrison
rongeurs kerrison

Micro Kerrison Rongeur 230 mm 9"
40° Up, Thin Footplate, 9 mm Opening

DESCRIPTION	LENGTH	CODE
1 mm	9 in 230 mm	SI-786-00-86
2 mm	9 in 230 mm	SI-786-00-86A
3 mm	9 in 230 mm	SI-786-00-86B
4 mm	9 in 230 mm	SI-786-00-86C
5 mm	9 in 230 mm	SI-786-00-86D
6 mm	9 in 230 mm	SI-786-00-86E



Micro Kerrison Rongeur 250 mm 10"
40° Up, Thin Footplate, 9 mm Opening

DESCRIPTION	LENGTH	CODE
1 mm	10 in 250 mm	SI-786-00-87
2 mm	10 in 250 mm	SI-786-00-87A
3 mm	10 in 250 mm	SI-786-00-87B
4 mm	10 in 250 mm	SI-786-00-87C
5 mm	10 in 250 mm	SI-786-00-87D

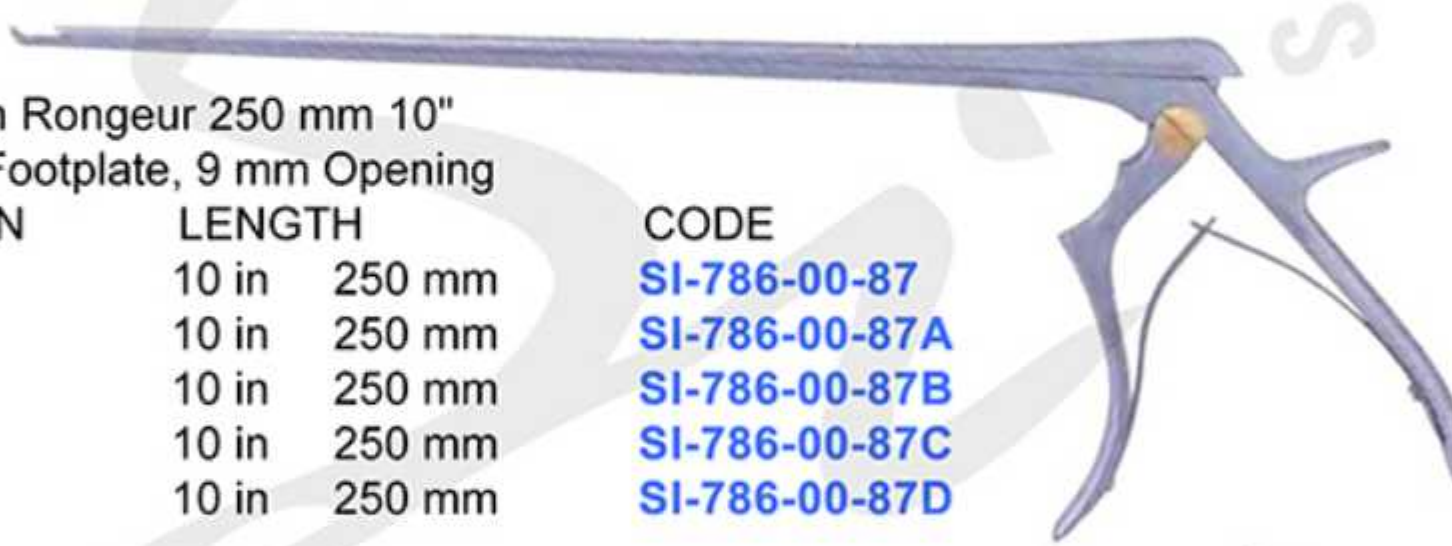

Micro Kerrison Rongeur 280 mm 11"
40° Up, Thin Footplate, 9 mm Opening

DESCRIPTION	LENGTH	CODE
1 mm	11 in 280 mm	SI-786-00-88
2 mm	11 in 280 mm	SI-786-00-88A
3 mm	11 in 280 mm	SI-786-00-88B
4 mm	11 in 280 mm	SI-786-00-88C
5 mm	11 in 280 mm	SI-786-00-88D
6 mm	11 in 280 mm	SI-786-00-88E



Rongeurs Kerrison
Rongeurs Kerrison
Rongeurs Kerrison
rongeurs kerrison

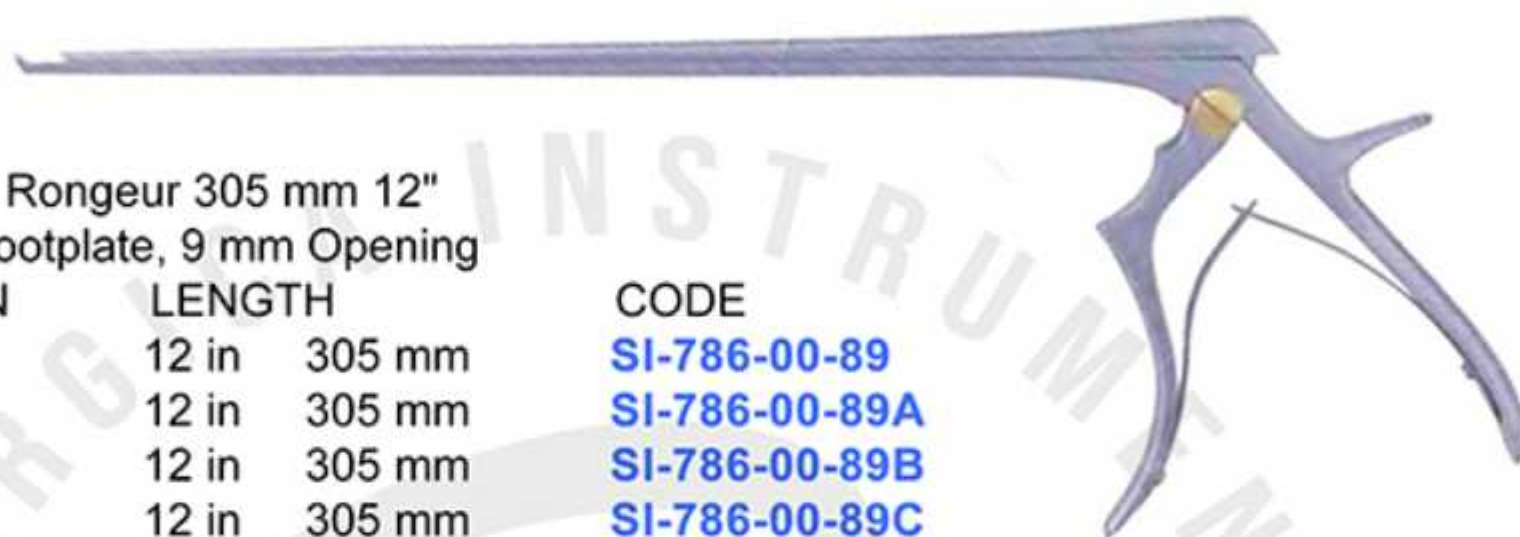

Micro Kerrison Rongeur 305 mm 12"
40° Up, Thin Footplate, 9 mm Opening

DESCRIPTION	LENGTH		CODE
2 mm	12 in	305 mm	SI-786-00-89
3 mm	12 in	305 mm	SI-786-00-89A
4 mm	12 in	305 mm	SI-786-00-89B
5 mm	12 in	305 mm	SI-786-00-89C



Micro Kerrison Rongeur 200 mm 8"
90° Down

DESCRIPTION	LENGTH		CODE
1 mm	8 in	200 mm	SI-786-00-90
2 mm	8 in	200 mm	SI-786-00-90A
3 mm	8 in	200 mm	SI-786-00-90B
4 mm	8 in	200 mm	SI-786-00-90C
5 mm	8 in	200 mm	SI-786-00-90D
6 mm	8 in	200 mm	SI-786-00-90E



Micro Kerrison Rongeur 230 mm 9"
90° Up, Thin Footplate, 9 mm Opening

DESCRIPTION	LENGTH		CODE
1 mm	9 in	230 mm	SI-786-00-91
2 mm	9 in	230 mm	SI-786-00-91A
3 mm	9 in	230 mm	SI-786-00-91B
4 mm	9 in	230 mm	SI-786-00-91C
5 mm	9 in	230 mm	SI-786-00-91D

Rongeurs Kerrison
Rongeurs Kerrison
Rongeurs Kerrison
rongeurs kerrison

Micro Kerrison Rongeur 200 mm 8"
90° Up, Thin Footplate, 9 mm Opening

DESCRIPTION	LENGTH		CODE
1 mm	8 in	200 mm	SI-786-00-92
2 mm	8 in	200 mm	SI-786-00-92A
3 mm	8 in	200 mm	SI-786-00-92B
4 mm	8 in	200 mm	SI-786-00-92C
5 mm	8 in	200 mm	SI-786-00-92D
6 mm	8 in	200 mm	SI-786-00-92E

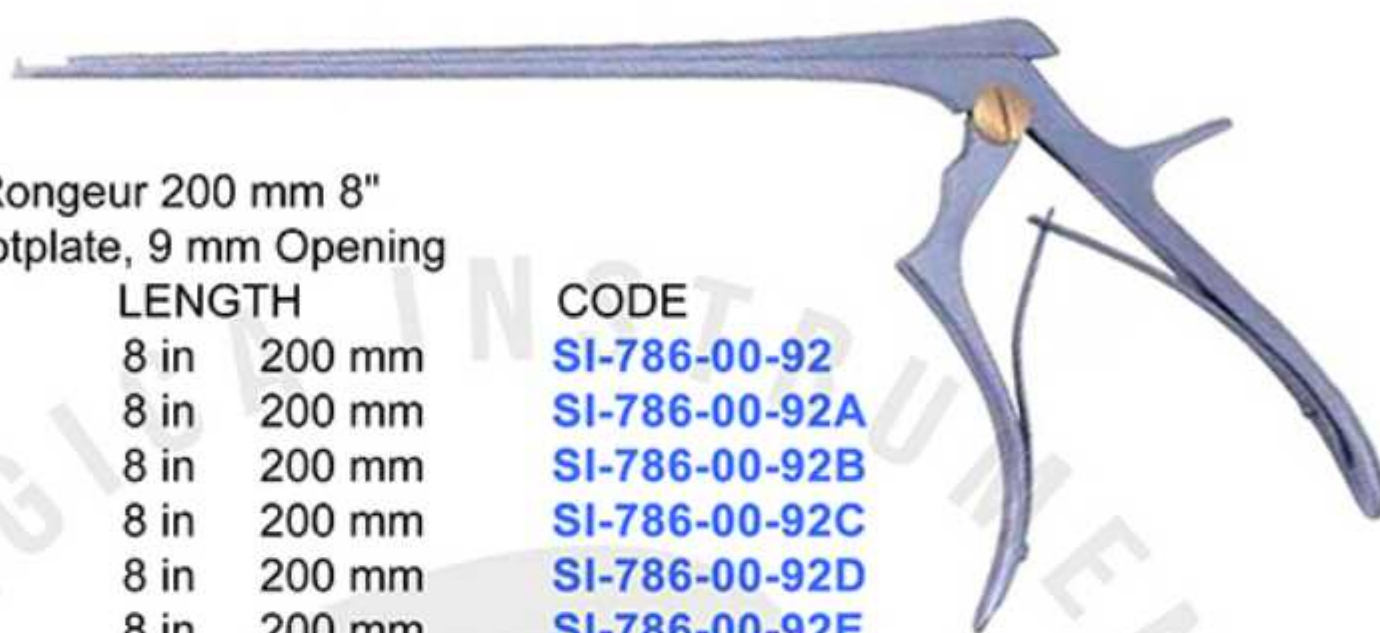

Micro Kerrison Rongeur 250 mm 10"
90° Up, Thin Footplate, 9 mm Opening

DESCRIPTION	LENGTH		CODE
1 mm	10 in	250 mm	SI-786-00-93
2 mm	10 in	250 mm	SI-786-00-93A
3 mm	10 in	250 mm	SI-786-00-93B
4 mm	10 in	250 mm	SI-786-00-93C
5 mm	10 in	250 mm	SI-786-00-93D

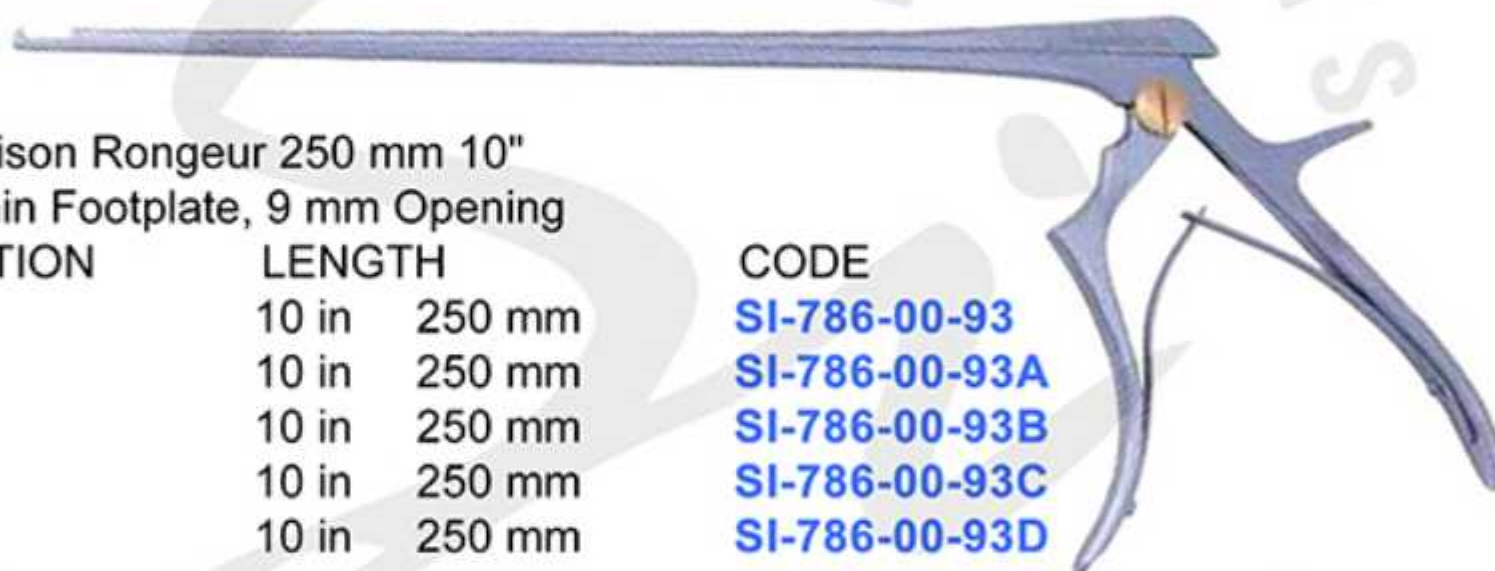

Micro Kerrison Rongeur 200 mm 8"
40° Up, with Ultra Coat

DESCRIPTION	LENGTH		CODE
1 mm	8 in	200 mm	SI-786-00-94
2 mm	8 in	200 mm	SI-786-00-94A
3 mm	8 in	200 mm	SI-786-00-94B
4 mm	8 in	200 mm	SI-786-00-94C
5 mm	8 in	200 mm	SI-786-00-94D



Rongeurs Kerrison
Rongeurs Kerrison
Rongeurs Kerrison
rongeurs kerrison



Micro Kerrison Rongeur 230 mm 9"
40° Up, with Ultra Coat

DESCRIPTION	LENGTH	CODE
1 mm	9 in 230 mm	SI-786-00-95
2 mm	9 in 230 mm	SI-786-00-95A
3 mm	9 in 230 mm	SI-786-00-95B
4 mm	9 in 230 mm	SI-786-00-95C
5 mm	9 in 230 mm	SI-786-00-95D



Micro Kerrison Rongeur 280 mm 11"
40° Up, Thin Footplate, with Ultra Coat, 9 mm Opening

DESCRIPTION	LENGTH	CODE
1 mm	11 in 280 mm	SI-786-00-96
2 mm	11 in 280 mm	SI-786-00-96A
3 mm	11 in 280 mm	SI-786-00-96B
4 mm	11 in 280 mm	SI-786-00-96C
5 mm	11 in 280 mm	SI-786-00-96D



Micro Kerrison Rongeur 200 mm 8"
40° Up, Small Handle, 15 mm Opening

DESCRIPTION	LENGTH	CODE
2 mm	8 in 200 mm	SI-786-00-97
3 mm	8 in 200 mm	SI-786-00-97A
4 mm	8 in 200 mm	SI-786-00-97B
5 mm	8 in 200 mm	SI-786-00-97C

Rongeurs Kerrison
Rongeurs Kerrison
Rongeurs Kerrison
rongeurs kerrison

Micro Kerrison Convertible Rongeur 175 mm 7"
40° Up, Thin Footplate

DESCRIPTION	LENGTH	CODE
1 mm	7 in 175 mm	SI-786-00-98
2 mm	7 in 175 mm	SI-786-00-98A
3 mm	7 in 175 mm	SI-786-00-98B
4 mm	7 in 175 mm	SI-786-00-98C
5 mm	7 in 175 mm	SI-786-00-98D



Micro Kerrison Convertible Ejector Rongeur
40° Up, Thin Footplate, with Ejector 175 mm 7"

DESCRIPTION	LENGTH	CODE
3 mm	7 in 175 mm	SI-786-00-99
4 mm	7 in 175 mm	SI-786-00-99A
5 mm	7 in 175 mm	SI-786-00-99B



Micro Kerrison Convertible Rongeur 175 mm 7"
40° Up, Regular Footplate

DESCRIPTION	LENGTH	CODE
1 mm	7 in 175 mm	SI-786-00-100
2 mm	7 in 175 mm	SI-786-00-100A
3 mm	7 in 175 mm	SI-786-00-100B
4 mm	7 in 175 mm	SI-786-00-100C
5 mm	7 in 175 mm	SI-786-00-100D



Rongeurs Kerrison
Rongeurs Kerrison
Rongeurs Kerrison
rongeurs kerrison

Microsect Shaver Rongeur 216 mm 8 1/2"
45° Up

DESCRIPTION	LENGTH	CODE
1.5 mm	8 1/2 in 216 mm	SI-786-00-101
2 mm	8 1/2 in 216 mm	SI-786-00-101A
2.5 mm	8 1/2 in 216 mm	SI-786-00-101B
3 mm	8 1/2 in 216 mm	SI-786-00-101C
4 mm	8 1/2 in 216 mm	SI-786-00-101D



Microsect Shaver Rongeur 254 mm 10"
45° Up

DESCRIPTION	LENGTH	CODE
1.5 mm	10 in 254mm	SI-786-00-102
2 mm	10 in 254mm	SI-786-00-102A
2.5 mm	10 in 254mm	SI-786-00-102B
3 mm	10 in 254mm	SI-786-00-102C
4 mm	10 in 254mm	SI-786-00-102D



Microsect Shaver Rongeur 305 mm 12"
45° Up

DESCRIPTION	LENGTH	CODE
1.5 mm	12 in 305 mm	SI-786-00-103
2 mm	12 in 305 mm	SI-786-00-103A
2.5 mm	12 in 305 mm	SI-786-00-103B
3 mm	12 in 305 mm	SI-786-00-103C
4 mm	12 in 305 mm	SI-786-00-103D



Rongeurs Kerrison
Rongeurs Kerrison
Rongeurs Kerrison
rongeurs kerrison

Opti-Length Kerrison Lumbar Rongeur
305 mm 12" 40°

DESCRIPTION	LENGTH		CODE
2 mm	12 in	305 mm	SI-786-00-104
3 mm	12 in	305 mm	SI-786-00-104A
4 mm	12 in	305 mm	SI-786-00-104B

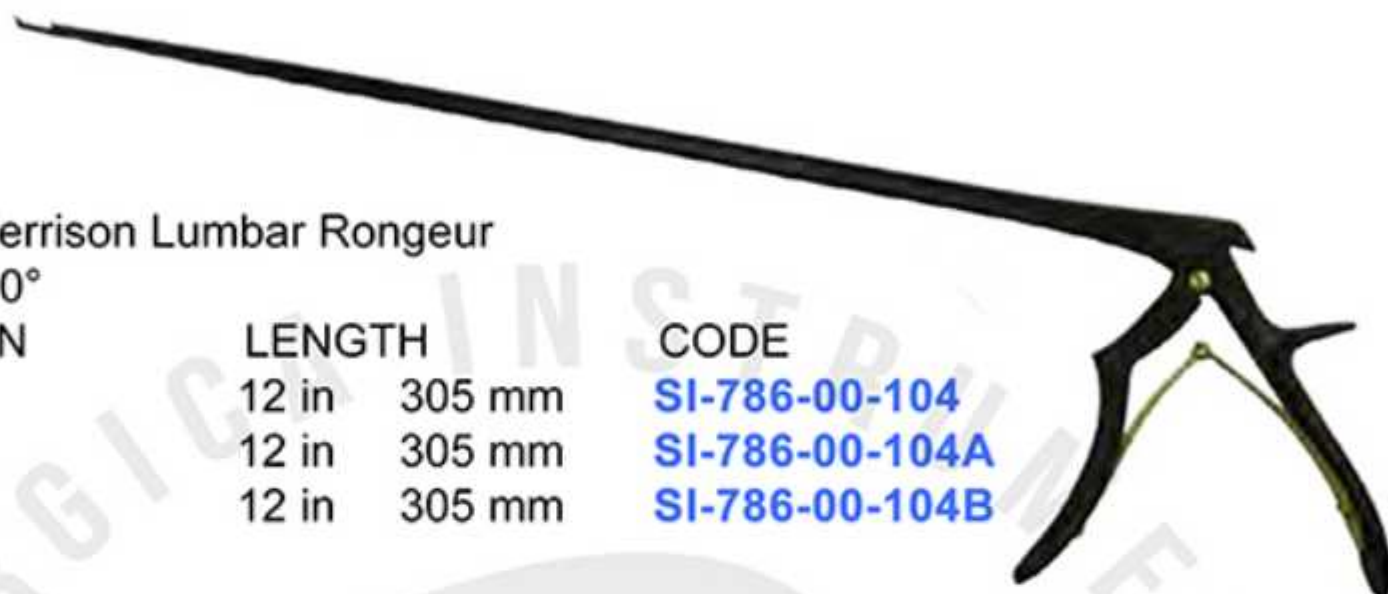

Opti-Length Kerrison Lumbar Rongeur
380 mm 15"

DESCRIPTION	LENGTH		CODE
1 mm	15 in	380 mm	SI-786-00-105
2 mm	15 in	380 mm	SI-786-00-105A
3 mm	15 in	380 mm	SI-786-00-105B
4 mm	15 in	380 mm	SI-786-00-105C
5 mm	15 in	380 mm	SI-786-00-105D

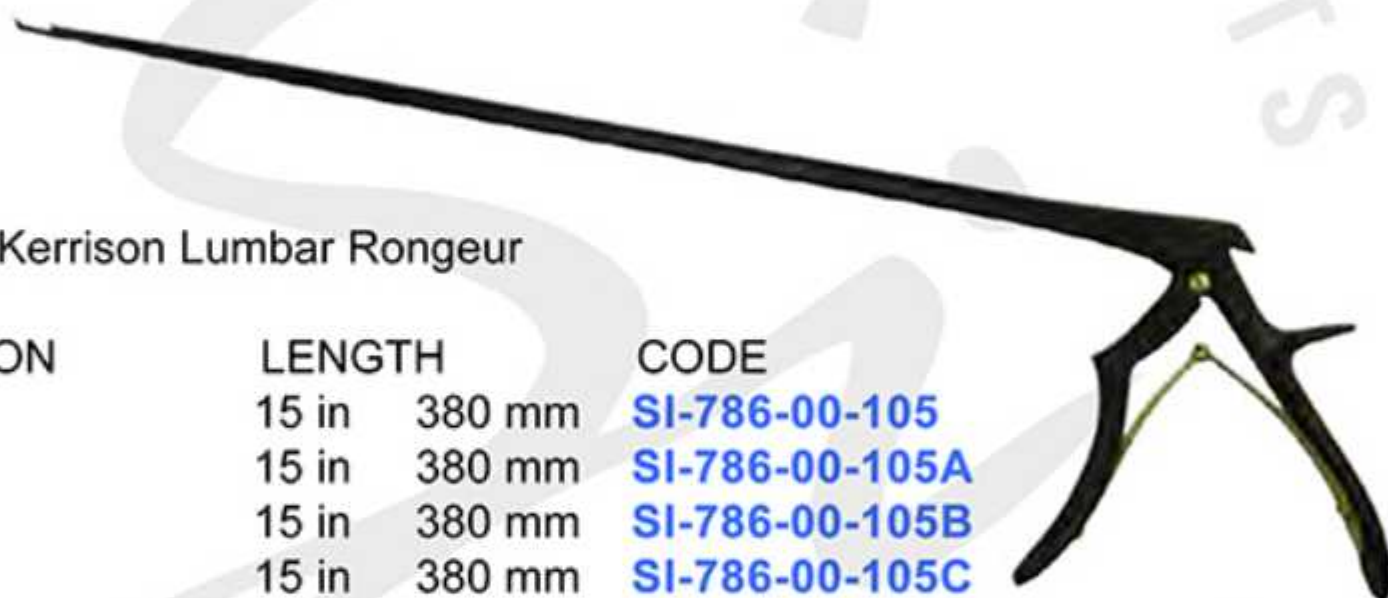

Opti-Length Microsect Shaver Rongeur
254 mm 10" 45°, Up Bite

TIP SIZE	LENGTH		CODE
1.5 mm	10 in	254 mm	SI-786-00-106
2 mm	10 in	254 mm	SI-786-00-106A
2.5 mm	10 in	254 mm	SI-786-00-106B
3 mm	10 in	254 mm	SI-786-00-106C
4 mm	10 in	254 mm	SI-786-00-106D
1.5 mm	12 in	305 mm	SI-786-00-106E
2 mm	12 in	305 mm	SI-786-00-106F
2.5 mm	12 in	305 mm	SI-786-00-106G
3 mm	12 in	305 mm	SI-786-00-106H
4 mm	12 in	305 mm	SI-786-00-106I



Rongeurs Kerrison, Cervical
Rongeurs Kerrison, Cervical
Rongeurs Kerrison, zervikal
Rongeurs Kerrison, Cervical

Classic T-F Cervical
178 mm 7"
1 mm
40° Up
SI-786-00-107



Kerrison Cervical Rongeur 90° Down,
Thin Footplate 152 mm

DESCRIPTION	LENGTH	CODE
2 mm	6 in 152 mm	SI-786-00-108
3 mm	6 in 152 mm	SI-786-00-108A
4 mm	6 in 152 mm	SI-786-00-108B
5 mm	6 in 152 mm	SI-786-00-108C

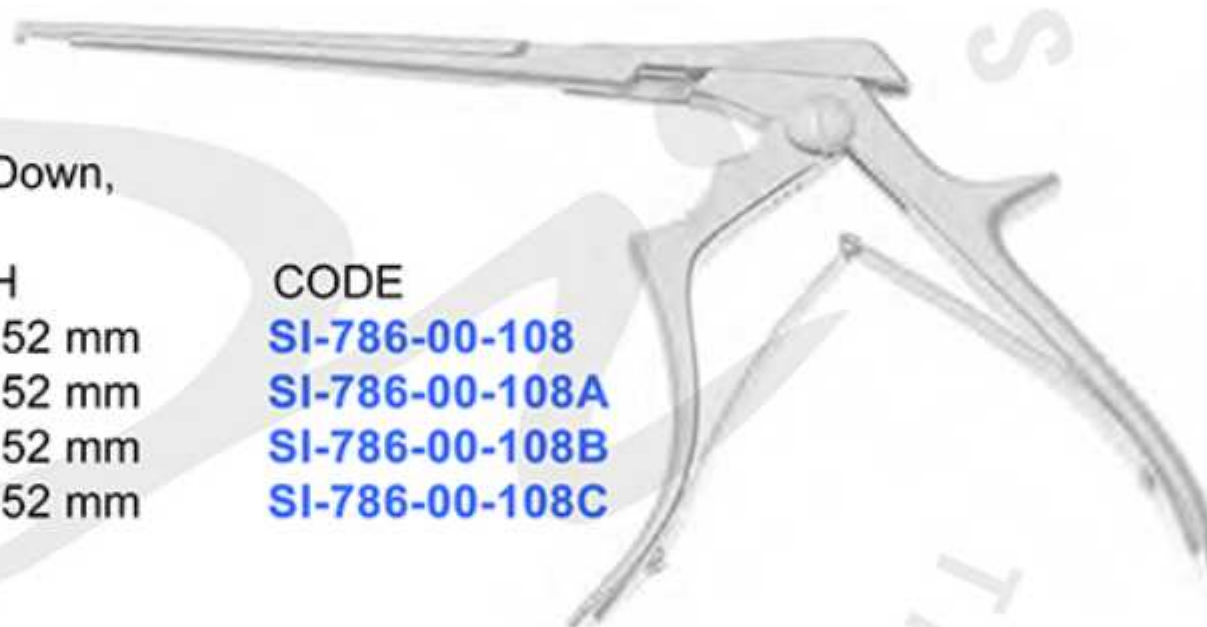

Kerrison Cervical Rongeur 90° Up, Thin Footplate
152 mm

DESCRIPTION	LENGTH	CODE
2 mm	6 in 152 mm	SI-786-00-109
3 mm	6 in 152 mm	SI-786-00-109A
4 mm	6 in 152 mm	SI-786-00-109B
5 mm	6 in 152 mm	SI-786-00-109C



Rongeurs Kerrison, Cervical
Rongeurs Kerrison, Cervical
Rongeurs Kerrison, zervikal
Rongeurs Kerrison, Cervical

Kerrison Cervical Rongeur
90° Up, Thin Footplate 178 mm

DESCRIPTION	LENGTH	CODE
2 mm	7 in 178 mm	SI-786-00-110
3 mm	7 in 178 mm	SI-786-00-110A
4 mm	7 in 178 mm	SI-786-00-110B
5 mm	7 in 178 mm	SI-786-00-110C

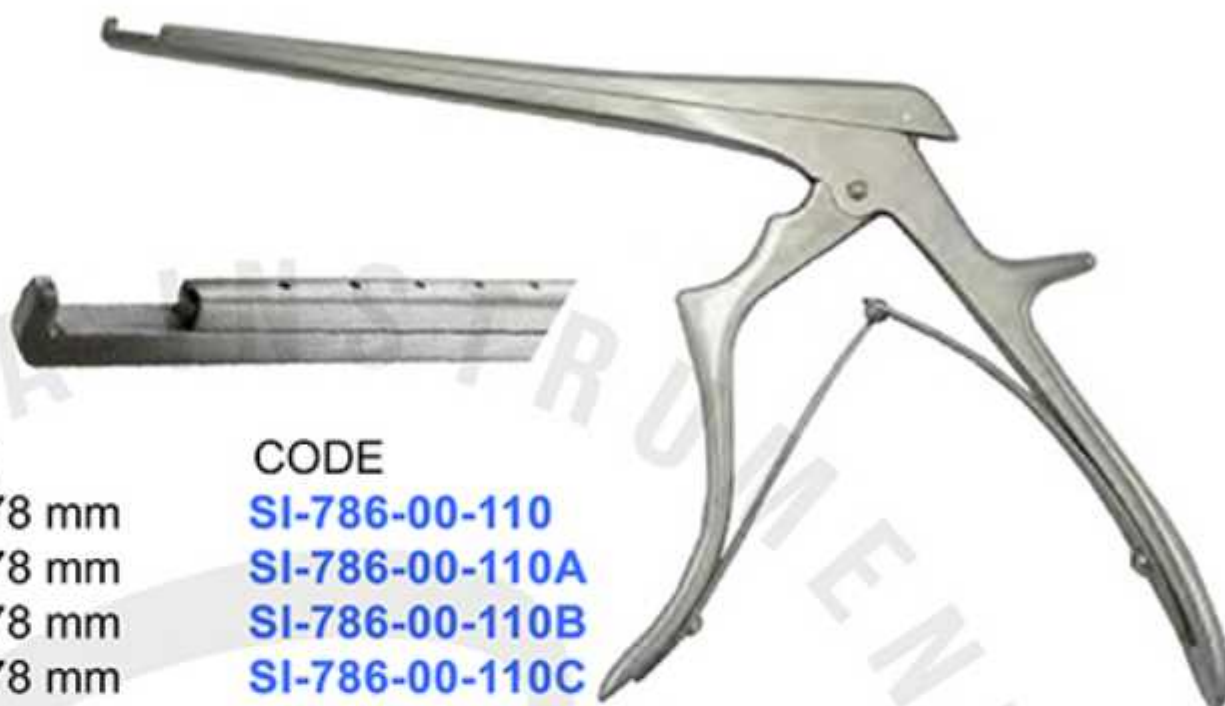

Kerrison Cervical Rongeur
90° Up, Thin Footplate 203 mm

DESCRIPTION	LENGTH	CODE
2 mm	8 in 203 mm	SI-786-00-111
3 mm	8 in 203 mm	SI-786-00-111A
4 mm	8 in 203 mm	SI-786-00-111B
5 mm	8 in 203 mm	SI-786-00-111C



RapidClean Cervical Kerrison Rongeur
180 mm 7" 40° Up, Detachable

DESCRIPTION	LENGTH	CODE
1 mm	7 in 180 mm	SI-786-00-112
2 mm	7 in 180 mm	SI-786-00-112A
3 mm	7 in 180 mm	SI-786-00-112B
4 mm	7 in 180 mm	SI-786-00-112C

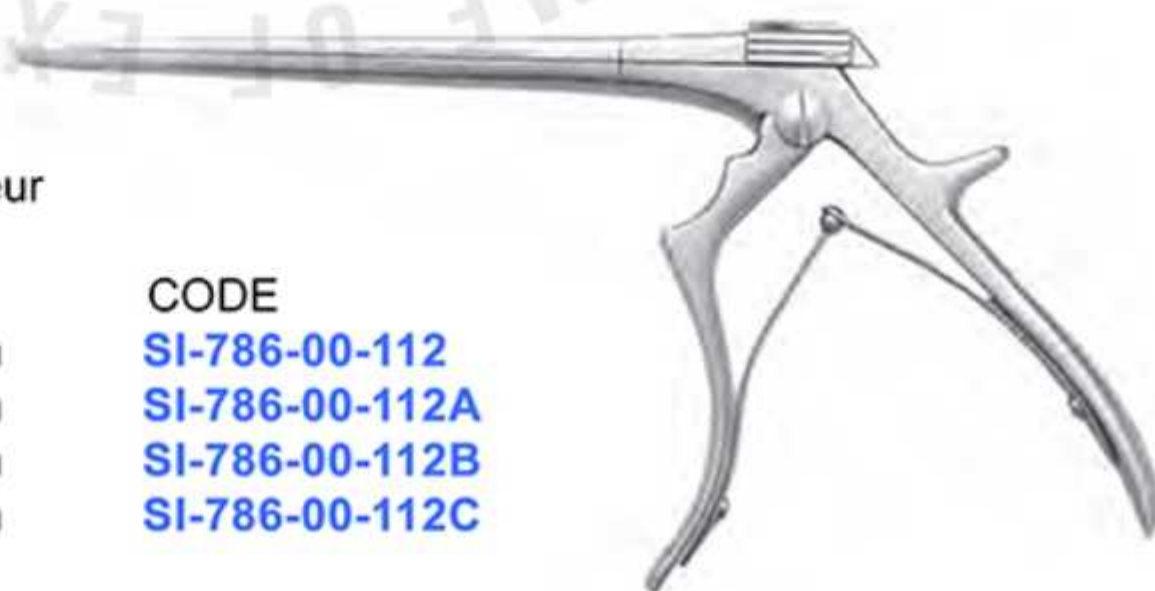

Rongeurs Kerrison, Cervical
Rongeurs Kerrison, Cervical
Rongeurs Kerrison, zervikal
Rongeurs Kerrison, Cervical



RapidClean Cervical Kerrison Rongeur
200 mm 8" 40° Up, Detachable

DESCRIPTION	LENGTH	CODE
1 mm	8 in 200 mm	SI-786-00-113
2 mm	8 in 200 mm	SI-786-00-113A
3 mm	8 in 200 mm	SI-786-00-113B
4 mm	8 in 200 mm	SI-786-00-113C

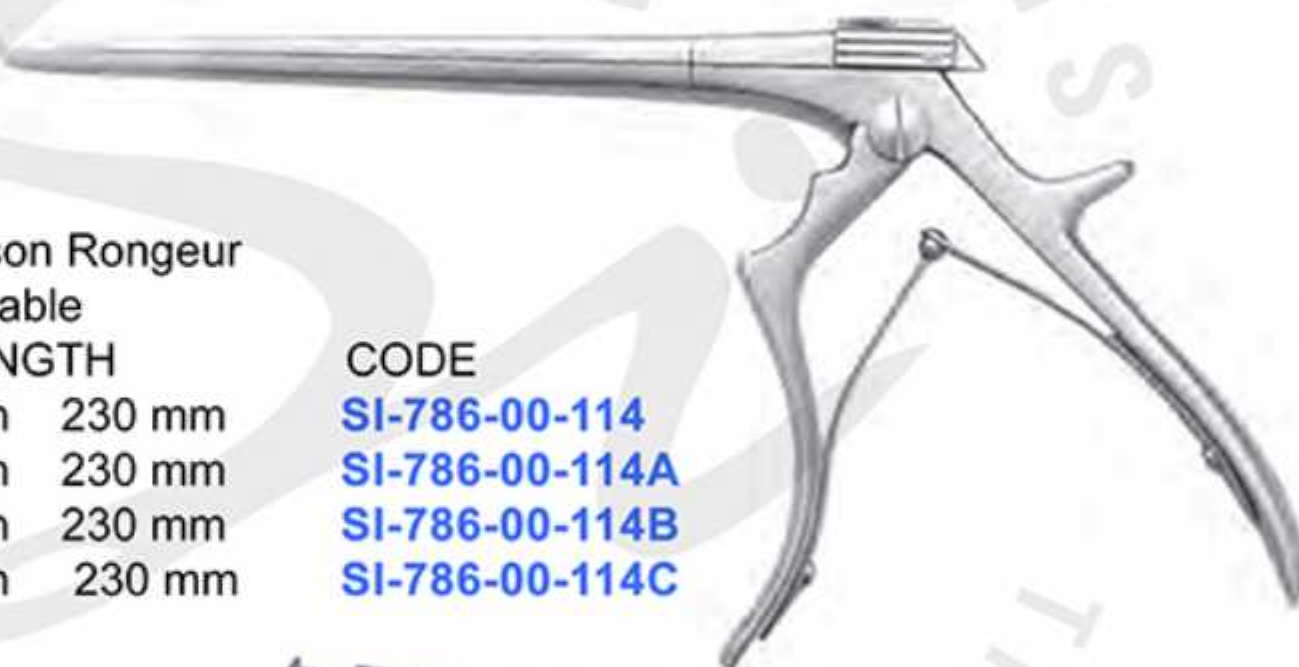

RapidClean Cervical Kerrison Rongeur
230 mm 9" 40° Up, Detachable

DESCRIPTION	LENGTH	CODE
1 mm	9 in 230 mm	SI-786-00-114
2 mm	9 in 230 mm	SI-786-00-114A
3 mm	9 in 230 mm	SI-786-00-114B
4 mm	9 in 230 mm	SI-786-00-114C

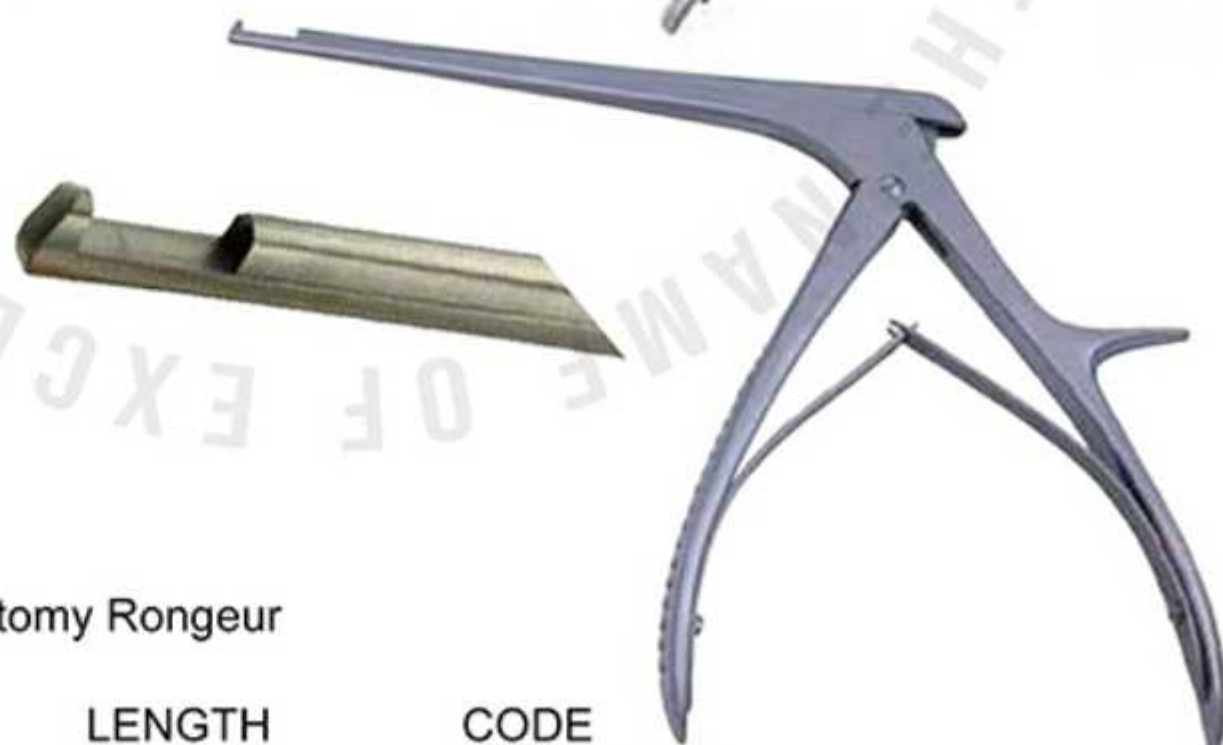

Schlesinger Cervical Laminectomy Rongeur
152 mm 6"

DESCRIPTION	BITE	LENGTH	CODE
Down Biting	3 mm	6 in 152 mm	SI-786-00-115
Down Biting	5 mm	6 in 152 mm	SI-786-00-115A
Up Biting	3 mm	6 in 152 mm	SI-786-00-115B
Up Biting	5 mm	6 in 152 mm	SI-786-00-115C

Rongeurs Kerrison Laminectomie
Rongeurs Kerrison Laminectomy
Rongeurs Kerrison Laminektomie
Rongeurs Kerrison Laminectomía



Ferris-Smith Kerrison Rongeur
Down Biting, 5 mm 6 in 152 mm

DESCRIPTION	LENGTH	CODE
Down Biting,	5 mm 6 in 152 mm	SI-786-00-116
Up Biting,	5 mm 6 in 152 mm	SI-786-00-116A

CODE
[SI-786-00-116](#)
[SI-786-00-116A](#)



Kerrison Laminectomy Rongeur
Down Biting Shaft 152 mm

DESCRIPTION	LENGTH	CODE
3 mm	6 in 152 mm	SI-786-00-117
5 mm	6 in 152 mm	SI-786-00-117A
3 mm	7 1/2 in 191 mm	SI-786-00-117B
5 mm	7 1/2 in 191 mm	SI-786-00-117C

CODE
[SI-786-00-117](#)
[SI-786-00-117A](#)
[SI-786-00-117B](#)
[SI-786-00-117C](#)

Rongeurs Kerrison Laminectomie
Rongeurs Kerrison Laminectomy
Rongeurs Kerrison Laminektomie
Rongeurs Kerrison Laminectomia



Ferris-Smith Kerrison Rongeur

Up Biting, 5 mm 6 in 152 mm

DESCRIPTION	LENGTH	CODE
Down Biting,	5 mm 6 in 152 mm	SI-786-00-118
Up Biting,	5 mm 6 in 152 mm	SI-786-00-118A

Leksell Laminectomy Rongeur

Double Action

DESCRIPTION	LENGTH	CODE
Regular Curve, 1 mm	14 in 356mm	SI-786-00-119
Regular Curve, 2 mm	14 in 356 mm	SI-786-00-119A
Regular Curve, 3 mm	14 in 356 mm	SI-786-00-119B
Regular Curve, 4 mm	14 in 356 mm	SI-786-00-119C
Regular Curve, 5 mm	14 in 356 mm	SI-786-00-119D
Regular Curve, 6 mm	14 in 356 mm	SI-786-00-119E
Full Curve, 1 mm	14 in 356 mm	SI-786-00-119F
Full Curve, 2 mm	14 in 356 mm	SI-786-00-119G
Full Curve, 3 mm	14 in 356 mm	SI-786-00-119H
Full Curve, 4 mm	14 in 356 mm	SI-786-00-119I
Full Curve, 5 mm	14 in 356 mm	SI-786-00-119J
Full Curve, 6 mm	14 in 356 mm	SI-786-00-119K



Raney Laminectomy Rongeur

191 mm 7 1/2"

7 mm

SI-786-00-120

Rongeurs Kerrison Rapidclean
Rongeurs Kerrison Rapidclean
Rongeurs Kerrison Rapidclean
Rongeurs Kerrison Rapidclean

Ceramic Coated Micro Kerrison Convertible Rongeur
40° Up, Regular Footplate

DESCRIPTION	LENGTH		CODE
1 mm	7 in	175 mm	SI-786-00-121
2 mm	7 in	175 mm	SI-786-00-121A
3 mm	7 in	175 mm	SI-786-00-121B
4 mm	7 in	175 mm	SI-786-00-121C
5 mm	7 in	175 mm	SI-786-00-121D



Ceramic Coated Micro Kerrison Convertible Rongeur
40° Up, Thin Footplate

DESCRIPTION	LENGTH		CODE
1 mm	8 in	200 mm	SI-786-00-122
2 mm	8 in	200 mm	SI-786-00-122A
3 mm	8 in	200 mm	SI-786-00-122B
4 mm	8 in	200 mm	SI-786-00-122C
5 mm	8 in	200 mm	SI-786-00-122D



Ceramic Coated Micro Kerrison Convertible Rongeur
with Ejector 40° Up, Thin Footplate

DESCRIPTION	LENGTH		CODE
1 mm	8 in	200 mm	SI-786-00-123
2 mm	8 in	200 mm	SI-786-00-123A
3 mm	8 in	200 mm	SI-786-00-123B



Rongeurs Kerrison Rapidclean
Rongeurs Kerrison Rapidclean
Rongeurs Kerrison Rapidclean
Rongeurs Kerrison Rapidclean

Ceramic Coated Micro Kerrison Convertible Rongeur
40° Up, Regular Footplate

DESCRIPTION	LENGTH	CODE
1 mm	8 in 200 mm	SI-786-00-124
2 mm	8 in 200 mm	SI-786-00-124A
3 mm	8 in 200 mm	SI-786-00-124B
4 mm	8 in 200 mm	SI-786-00-124C
5 mm	8 in 200 mm	SI-786-00-124D



Micro Kerrison Convertible Ejector Rongeur
40° Up, Thin Footplate 230 mm 9"

DESCRIPTION	LENGTH	CODE
1 mm	9 in 230 mm	SI-786-00-125
2 mm	9 in 230 mm	SI-786-00-125A
3 mm	9 in 230 mm	SI-786-00-125B
4 mm	9 in 230 mm	SI-786-00-125C
5 mm	9 in 230 mm	SI-786-00-125D



Rongeurs Kerrison Rapidclean
Rongeurs Kerrison Rapidclean
Rongeurs Kerrison Rapidclean
Rongeurs Kerrison Rapidclean



Micro Kerrison Convertible Ejector Rongeur
40° Up, Regular Footplate 230 mm 9"

DESCRIPTION	LENGTH	CODE
1 mm	9 in 230 mm	SI-786-00-126
2 mm	9 in 230 mm	SI-786-00-126A
3 mm	9 in 230 mm	SI-786-00-126B
4 mm	9 in 230 mm	SI-786-00-126C
5 mm	9 in 230 mm	SI-786-00-126D



RapidClean Opti-Length Kerrison Detachable
Lumbar Rongeur 254 mm 10" 40° Up Bite with Ejector

DESCRIPTION	LENGTH	CODE
2 mm	10 in 254 mm	SI-786-00-127
2 mm	11 in 280 mm	SI-786-00-127A
3 mm	10 in 254 mm	SI-786-00-127B
3 mm	11 in 280 mm	SI-786-00-127C
2 mm	12 in 305 mm	SI-786-00-127D
3 mm	12 in 305 mm	SI-786-00-127E

Rongeurs Kerrison, Spurling
Rongeurs Kerrison, Spurling
Rongeurs Kerrison, Spurling
Pinzas Kerrison, Spurling

Micro Kerrison Rongeur 150 mm 6"
40° Up, Thin Footplate

DESCRIPTION	LENGTH	CODE
2 mm	6 in 150 mm	SI-786-00-128
3 mm	6 in 150 mm	SI-786-00-128A
4 mm	6 in 150 mm	SI-786-00-128B
5 mm	6 in 150 mm	SI-786-00-128C



Spurling-Kerrison Rongeur 2 mm, 8 " 200 mm
40° Up, with Ultra Coat, 15 mm Opening

DESCRIPTION	LENGTH	CODE
2 mm	8 in 200 mm	SI-786-00-129
3 mm	8 in 200 mm	SI-786-00-129A
4 mm	8 in 200 mm	SI-786-00-129B
5 mm	8 in 200 mm	SI-786-00-129C



Spurling-Kerrison Rongeur 8 " 200 mm
40° Up, 15 mm Opening

DESCRIPTION	LENGTH	CODE
2 mm	8 in 200 mm	SI-786-00-130
3 mm	8 in 200 mm	SI-786-00-130A
4 mm	8 in 200 mm	SI-786-00-130B
5 mm	8 in 200 mm	SI-786-00-130C
6 mm	8 in 200 mm	SI-786-00-130D



Rongeurs Kerrison, Spurling
Rongeurs Kerrison, Spurling
Rongeurs Kerrison, Spurling
Pinzas Kerrison, Spurling

Spurling-Kerrison Rongeur 9 " 230 mm
40° Up, 15 mm Opening

DESCRIPTION	LENGTH	CODE
2 mm	9 in 230 mm	SI-786-00-131
3 mm	9 in 230 mm	SI-786-00-131A
4 mm	9 in 230 mm	SI-786-00-131B
5 mm	9 in 230 mm	SI-786-00-131C
6 mm	9 in 230 mm	SI-786-00-131D



Spurling-Kerrison Rongeur 10 " 250 mm
40° Up, 15 mm Opening

DESCRIPTION	LENGTH	CODE
2 mm	10 in 250 mm	SI-786-00-132
3 mm	10 in 250 mm	SI-786-00-132A
4 mm	10 in 250 mm	SI-786-00-132B
5 mm	10 in 250 mm	SI-786-00-132C
6 mm	10 in 250 mm	SI-786-00-132D



Spurling-Kerrison Rongeur 8 " 200 mm
90° Down, 15 mm Opening

DESCRIPTION	LENGTH	CODE
2 mm	8 in 200 mm	SI-786-00-133
3 mm	8 in 200 mm	SI-786-00-133A
4 mm	8 in 200 mm	SI-786-00-133B
5 mm	8 in 200 mm	SI-786-00-133C



Rongeurs Kerrison, Spurling
Rongeurs Kerrison, Spurling
Rongeurs Kerrison, Spurling
Pinzas Kerrison, Spurling



Spurling-Kerrison Rongeur 11 " 280 mm
40° Up, 15 mm Opening

DESCRIPTION	LENGTH	CODE
2 mm	11 in 280 mm	SI-786-00-134
3 mm	11 in 280 mm	SI-786-00-134A
4 mm	11 in 280 mm	SI-786-00-134B
5 mm	11 in 280 mm	SI-786-00-134C



Spurling-Kerrison Rongeur 8 " 200 mm 90° Up
15 mm Opening

DESCRIPTION	LENGTH	CODE
2 mm	8 in 200 mm	SI-786-00-135
3 mm	8 in 200 mm	SI-786-00-135A
4 mm	8 in 200 mm	SI-786-00-135B
5 mm	8 in 200 mm	SI-786-00-135C

S*i* SURGICA
INSTRUMENTS
THE NAME OF EXCELLENCE



ENT INSTRUMENTS

- EAR SPECULA
- TUNING FORKS
- EAR CURETTES
- EAR CURETTES AND SHARP SPOONS
- EAR LOOPS
- EAR HOOKS
- EAR KNIVES
- & MORE



Spéculums auriculaires
Ear specula
Espéculos auriculares
Specoli auricolari



Toyntbee
36 mm – 1 1/2 "
Set, for adults

Fig. 1 4.5 Ø
Fig. 2 5.5 Ø
Fig. 3 6.5 Ø
Fig. 4 7.5 Ø

Fig. 1 **SI-78-5-01**
Fig. 2 **SI-78-5-01A**
Fig. 3 **SI-78-5-01B**
Fig. 4 **SI-78-5-01C**



Richnau Holmgren

Fig. 0 3.0 Ø
Fig. 1 4.0 Ø
Fig. 2 5.0 Ø
Fig. 3 6.0 Ø

Fig. 0 **SI-78-5-02**
Fig. 1 **SI-78-5-02A**
Fig. 2 **SI-78-5-02B**
Fig. 3 **SI-78-5-02C**



Gruber
Set for adults

Fig. 1 4.5 Ø
Fig. 2 5.5 Ø
Fig. 3 6.5 Ø
Fig. 4 7.5 Ø

Fig. 1 **SI-78-5-03**
Fig. 2 **SI-78-5-03A**
Fig. 3 **SI-78-5-03B**
Fig. 4 **SI-78-5-03C**

Spéculums auriculaires
Ear specula
Espéculos auriculares
Specoli auricolari



Gruber
Set for adults

Fig. 1
4.5 Ø

Fig. 2
5.5 Ø

Fig. 3
6.5 Ø

Fig. 4
7.5 Ø

Fig. 1 **SI-78-5-04**
Fig. 2 **SI-78-5-04A**
Fig. 3 **SI-78-5-04B**
Fig. 4 **SI-78-5-04C**



Zöllner
Set for adults, black

Fig. 1
5.5 x 6.5

Fig. 2
6.5 x 7.5

Fig. 3
7.5 x 8.5

Fig. 4
8.5 x 9.5

Fig. 5
9.5 x 10.5

Fig. 6
10.5x11.5

Fig. 1 **SI-78-5-05**
Fig. 2 **SI-78-5-05A**
Fig. 3 **SI-78-5-05B**
Fig. 4 **SI-78-5-05C**
Fig. 5 **SI-78-5-05D**
Fig. 6 **SI-78-5-05E**



Poltzer
Set for adults

Fig. 1
2 Ø

Fig. 2
3 Ø

Fig. 3
4 Ø

Fig. 4
5 Ø

Fig. 1 **SI-78-5-06**
Fig. 2 **SI-78-5-06A**
Fig. 3 **SI-78-5-06B**
Fig. 4 **SI-78-5-06C**

Spéculums auriculaires
Ear specula
Espéculos auriculares
Specoli auricolari



Boucheron
Set for adults

- Fig. 1
4.5 Ø
- Fig. 2
5.5 Ø
- Fig. 3
6.5 Ø
- Fig. 4
7.5 Ø

- Fig. 1 **SI-78-5-06**
- Fig. 2 **SI-78-5-06A**
- Fig. 3 **SI-78-5-06B**
- Fig. 4 **SI-78-5-06C**



Hartmann
Set for children

- Fig. 0
3.0 Ø
- Fig. 1
4.5 Ø
- Fig. 2
5.5 Ø

- Fig. 0 **SI-78-5-07**
- Fig. 1 **SI-78-5-07A**
- Fig. 2 **SI-78-5-07B**



Hartmann
Set for adults

- Fig. 1
4.5 Ø
- Fig. 2
5.5 Ø
- Fig. 3
6.5 Ø
- Fig. 4
7.5 Ø

- Fig. 1 **SI-78-5-08**
- Fig. 2 **SI-78-5-08A**
- Fig. 3 **SI-78-5-08B**
- Fig. 4 **SI-78-5-08C**



Hartmann
Set for adults, black

- Fig. 1
2.0 Ø
- Fig. 2
3.5 Ø
- Fig. 3
5.0 Ø
- Fig. 4
6.5 Ø
- Fig. 5
7.5 Ø

- Fig. 1 **SI-78-5-09**
- Fig. 2 **SI-78-5-09A**
- Fig. 3 **SI-78-5-09B**
- Fig. 4 **SI-78-5-09C**
- Fig. 5 **SI-78-5-09D**

Spéculums auriculaires
Ear specula
Espéculos auriculares
Specoli auricolari



Siegle

Set complete



Bruenings

Set complete

Diapasons
Tuning forks
Diapasones
Diapasoni



Lucae
c 128
SI-78-5-11
Variable up to h
(engl. b)

Rydel-Seiffer
C 64 / c 128
SI-78-5-12
with clamps C64,
without clamps c 128

French
C2 16
SI-78-5-13

French
C1 32
SI-78-5-14

Diapasons
Tuning forks
Diapasones
Diapasoni



Hartmann
C 64
SI-78-5-15



Hartmann
C 128
SI-78-5-16



Hartmann
C1 256
SI-78-5-17



Hartmann
a1 440
SI-78-5-18

Diapasons
Tuning forks
Diapasones
Diapasoni



Hartmann
c 128
SI-78-5-19

c1 256
SI-78-5-20

c2 512
SI-78-5-21

c3 1024
SI-78-5-22

c4 2048
SI-78-5-23

C5 4096
SI-78-5-24

Diapasons
Tuning forks
Diapasones
Diapasoni



Tuning Forks
c 128
SI-78-5-25
Aluminium

c1 256
SI-78-5-26

c2 512
SI-78-5-27





c3 1024
SI-78-5-28

c4 2048
SI-78-5-29





Curettes auriculaires
Ear curettes
Curetas auriculares
Curette auricolari



Buck
165mm
Blunt

			
Fig. 000	Fig. 00	Fig. 0	Fig. 1
SI-EC-16-01	SI-EC-16-01A	SI-EC-16-01B	SI-EC-16-01C





Buck
165mm
Blunt

			
Fig. 2	Fig. 3	Fig. 4	Fig. 5
SI-EC-16-01D	SI-EC-16-01E	SI-EC-16-01F	SI-EC-16-01G

Buck
165mm
Sharp

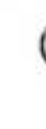













			
Fig. 000	Fig. 00	Fig. 0	Fig. 1
SI-EC-16-02	SI-EC-16-02A	SI-EC-16-02B	SI-EC-16-02C

Buck
165mm
Sharp

			
Fig. 2	Fig. 3	Fig. 4	Fig. 5
SI-EC-16-02D	SI-EC-16-02E	SI-EC-16-02F	SI-EC-16-02G

Curettes auriculaires
Ear cures
Curetas auriculares
Curette auricolari



					
Buck	Fig. 000	Fig. 00	Fig. 0	Fig. 0	Fig. 1
165mm	SI-EC-16-03	SI-EC-16-03A	SI-EC-16-03B	SI-EC-16-03B	SI-EC-16-03C
Curved, Blunt					
					
Buck		Fig. 2	Fig. 3	Fig. 4	
165mm		SI-EC-16-03D	SI-EC-16-03E	SI-EC-16-03F	
Curved, Blunt					
					
Buck	Fig. 000	Fig. 00	Fig. 0	Fig. 1	
165mm	SI-EC-16-04	SI-EC-16-04A	SI-EC-16-04B	SI-EC-16-04C	
Curved, Sharp					
					
Buck		Fig. 2	Fig. 3	Fig. 4	
165mm		SI-EC-16-04D	SI-EC-16-04E	SI-EC-16-04F	
Curved, Sharp					

Curettes auriculaires et cuillères tranchantes
Ear cures and sharp spoons
Curetas y cucharillas auriculares cortantes
Curette auricolari e cucchiari taglienti



Langenbeck
130 mm – 5"
SI-78-5-30
Blunt



Jansen
170mm–6 3/4 "
SI-78-5-31
Sharp



Gross
120 mm – 4 3/4 "
SI-78-5-32
Sharp, not fenestrated

Curettes auriculaires et cuillères tranchantes
Ear cures and sharp spoons
Curetas y cucharillas auriculares cortantes
Curette auricolari e cucchiari taglienti



Gross
120 mm – 4 3/4 "
SI-78-5-33
Blunt, not fenestrated



Jansen
160mm–6 1/4 "
SI-78-5-34
Sharp

Boucles d'oreille
Ear Loops
Ohrschlaufen
Orejas

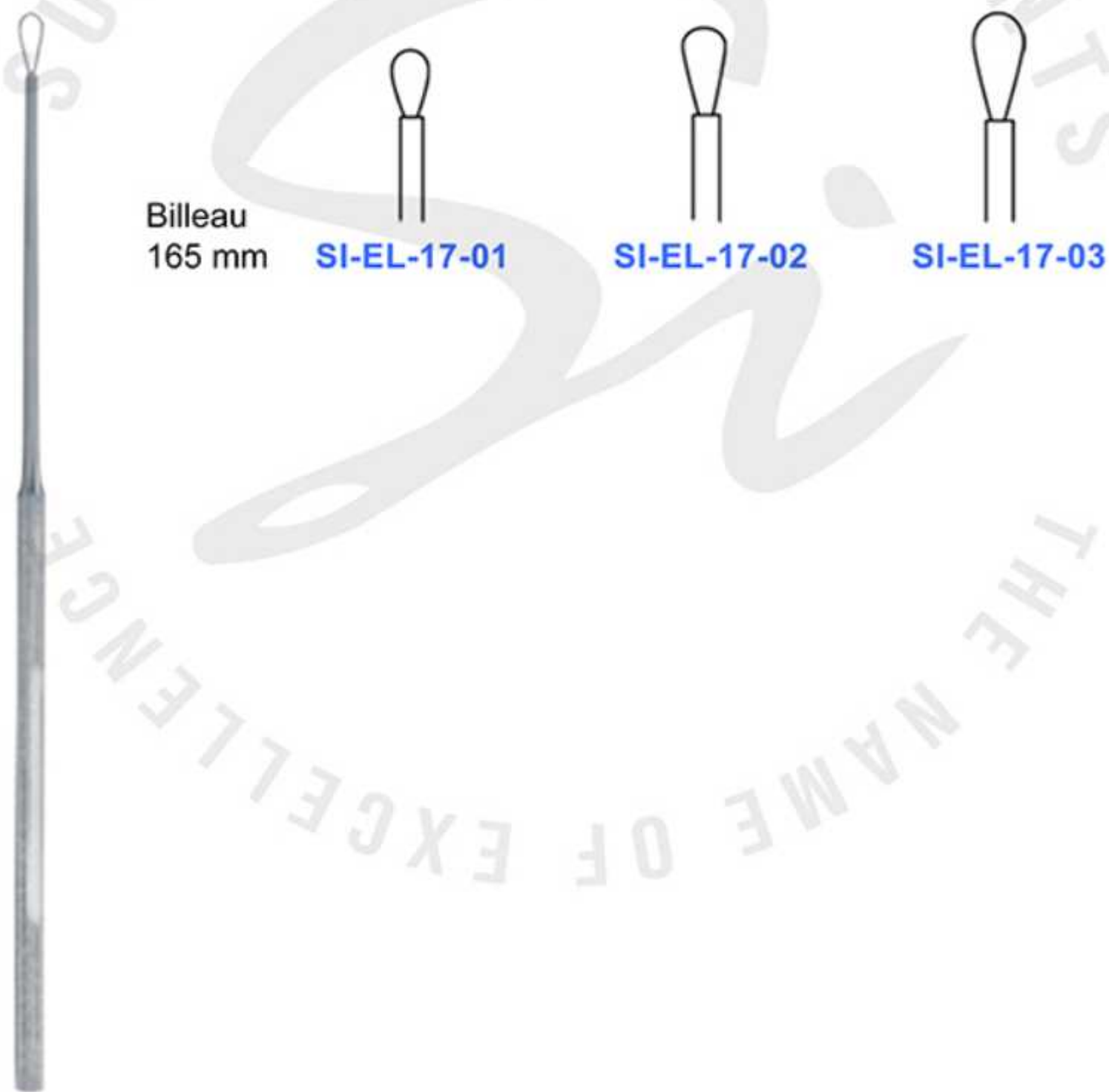

Crochets d'oreille
Ear hooks
Ohrhaken
ganchos para las orejas

Lucae
140 mm

SI-EH-18-01

SI-EH-18-02

SI-EH-18-03

SI-EH-18-04

SI-EH-18-05

SI-EH-18-06

SI-EH-18-07

SI-EH-18-08

SI-EH-18-09

SI-EH-18-10

Wagener
140 mm

Crochets d'oreille
Ear hooks
Ohrhaken
ganchos para las orejas

Day
160mm

SI-EH-18-11

SI-EH-18-12

Couteaux d'oreille
Ear Knives
Ohrmesser
Cuchillos para orejas



Muck
135 mm – 5 1/4 "
SI-EK-19-01



Gerzog-Sexton
170 mm – 6 3/4 "
SI-EK-19-02

Aiguilles de paracentèse
Paracentesis needles
Agujas para paracentesis
Aghi per paracentesi



Aiguilles de paracentèse
Paracentesis needles
Agujas para paracentesis
Aghi per paracentesi



Politzer
170mm-6 3/4 "
SI-78-5-41



Politzer
160 mm – 6 1/4 "
SI-78-5-42
Needle vertical



Politzer
160 mm – 6 1/4 "
SI-78-5-42
Needle horizontal

Serre noeuds auriculaires
Ear polypus snares
Polipótomos auriculares
Serranodi auricolari



Krause
160 mm – 6 1/4 "
SI-78-5-70



Krause-Voss
160 mm – 6 1/4 "
SI-78-5-71



Lange-Wilde
170 mm – 6 3/4 "
SI-78-5-72

Pinces pour polypes auriculaires
Ear polypus forceps
Pinzas para pólipos auriculares
Pinze per polipi auricolari

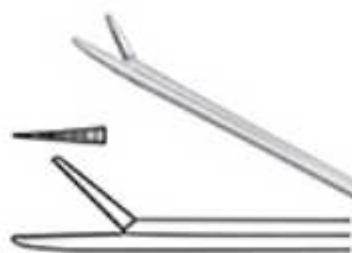

Hartmann-Wullstein
x = 85 mm – 3 1/4 "
SI-78-5-93



Hartmann-Wullstein
1 mm Ø
x = 85 mm – 3 1/4 "
SI-78-5-94



Pinces pour polypes auriculaires
Ear polypus forceps
Pinzas para pólipos auriculares
Pinze per polipi auricolari

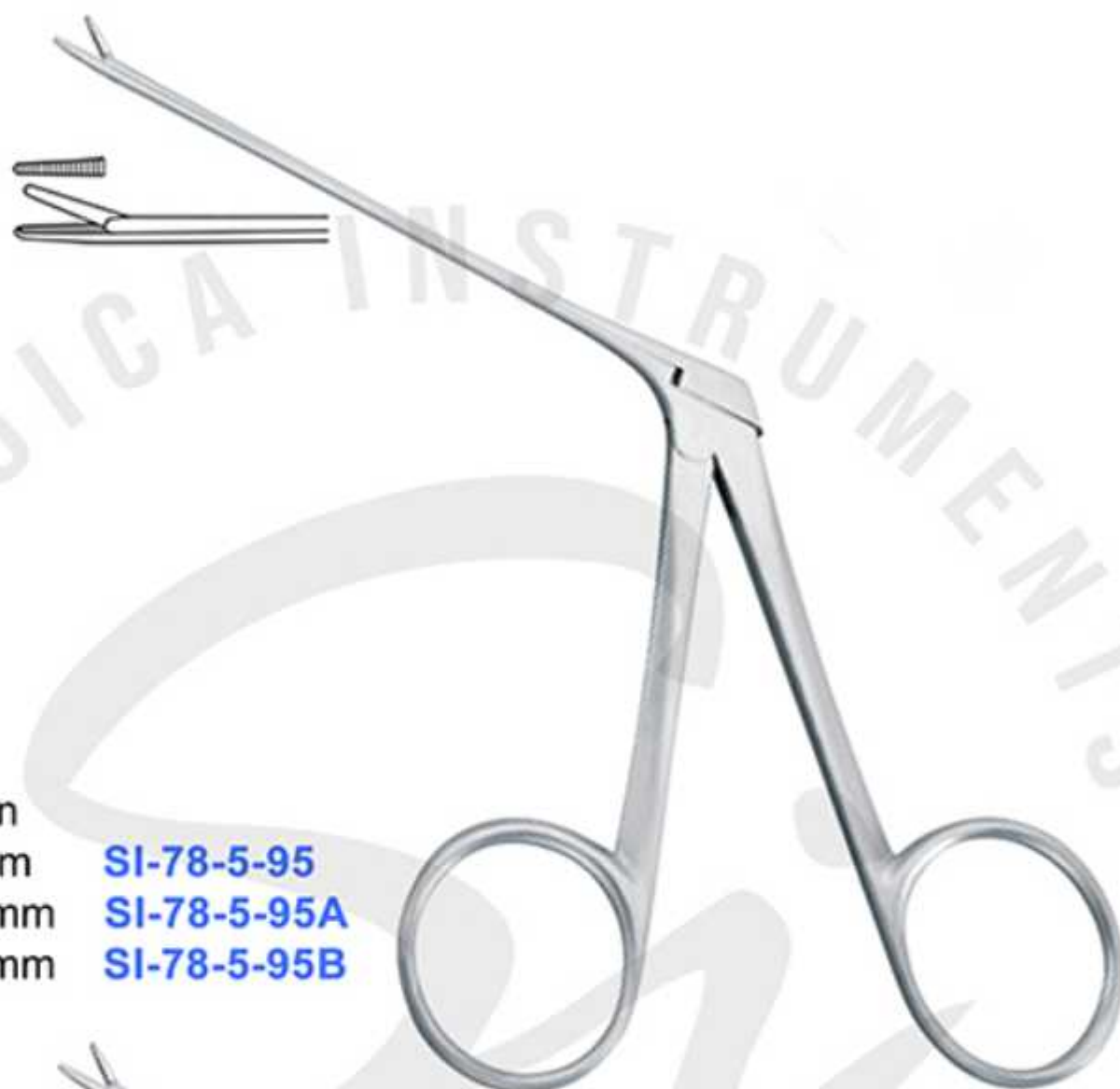

Hartmann
x = 85 mm **SI-78-5-95**
x = 140 mm **SI-78-5-95A**
x = 160 mm **SI-78-5-95B**

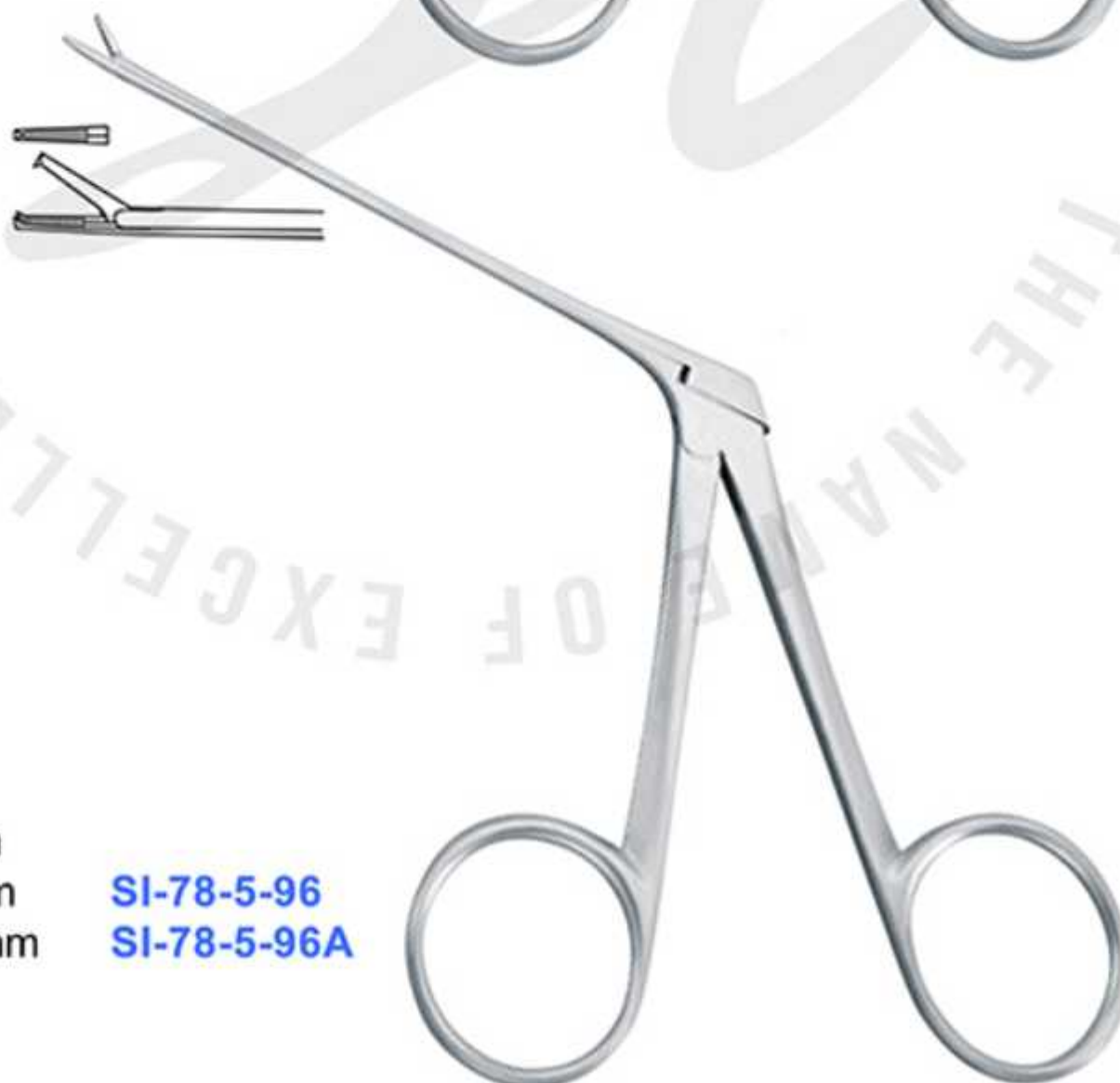

Hartmann
x = 85 mm **SI-78-5-96**
x = 140 mm **SI-78-5-96A**
1x2

Pinces pour polypes auriculaires
Ear polypus forceps
Pinzas para pólipos auriculares
Pinze per polipi auricolari

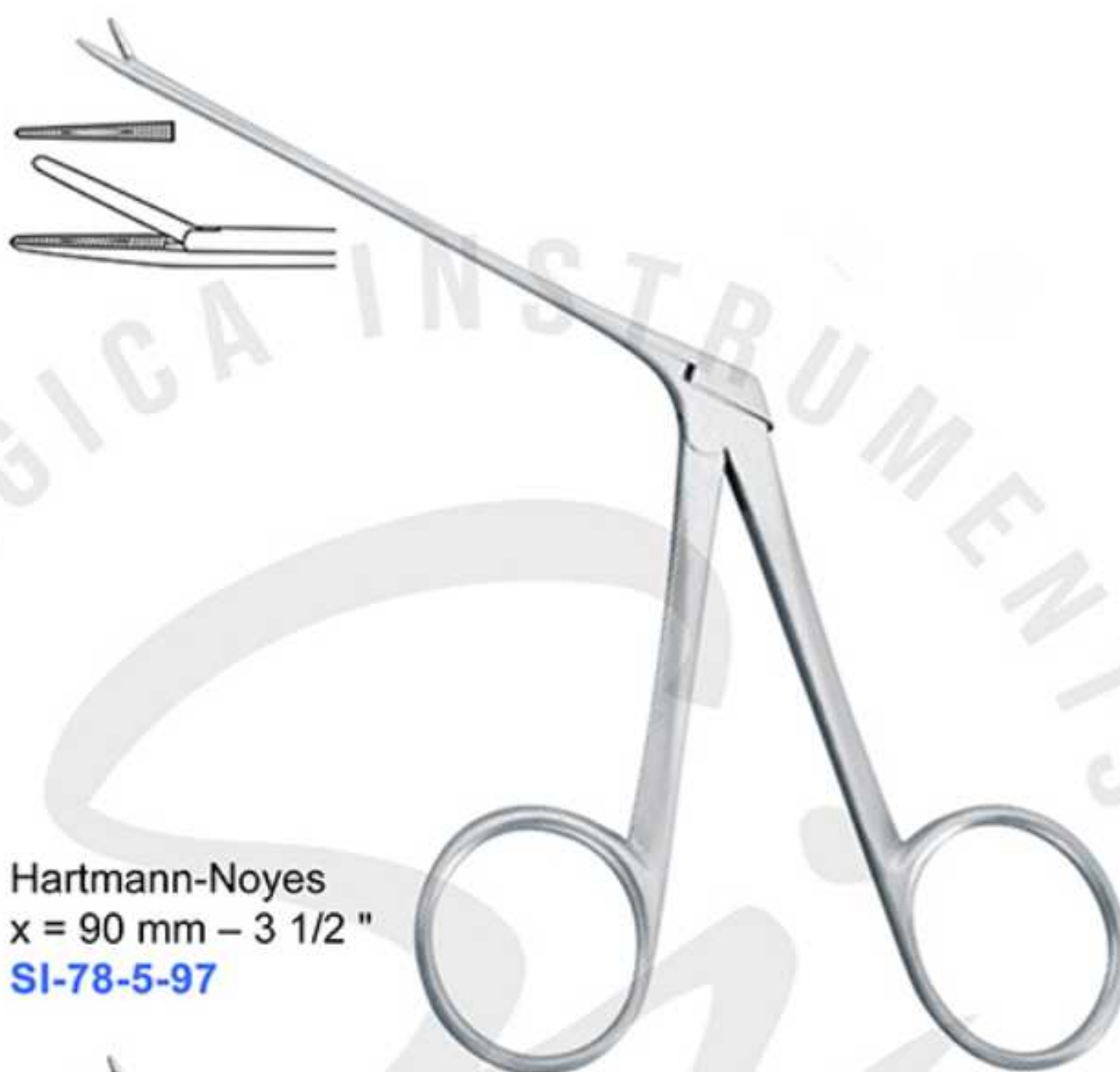

Hartmann-Noyes
x = 90 mm – 3 1/2 "
SI-78-5-97



Hartmann-Weingärtner
x = 85 mm – 3 1/4 "
SI-78-5-98

Pinces pour polypes auriculaires
Ear polypus forceps
Pinzas para pólipos auriculares
Pinze per polipi auricolari

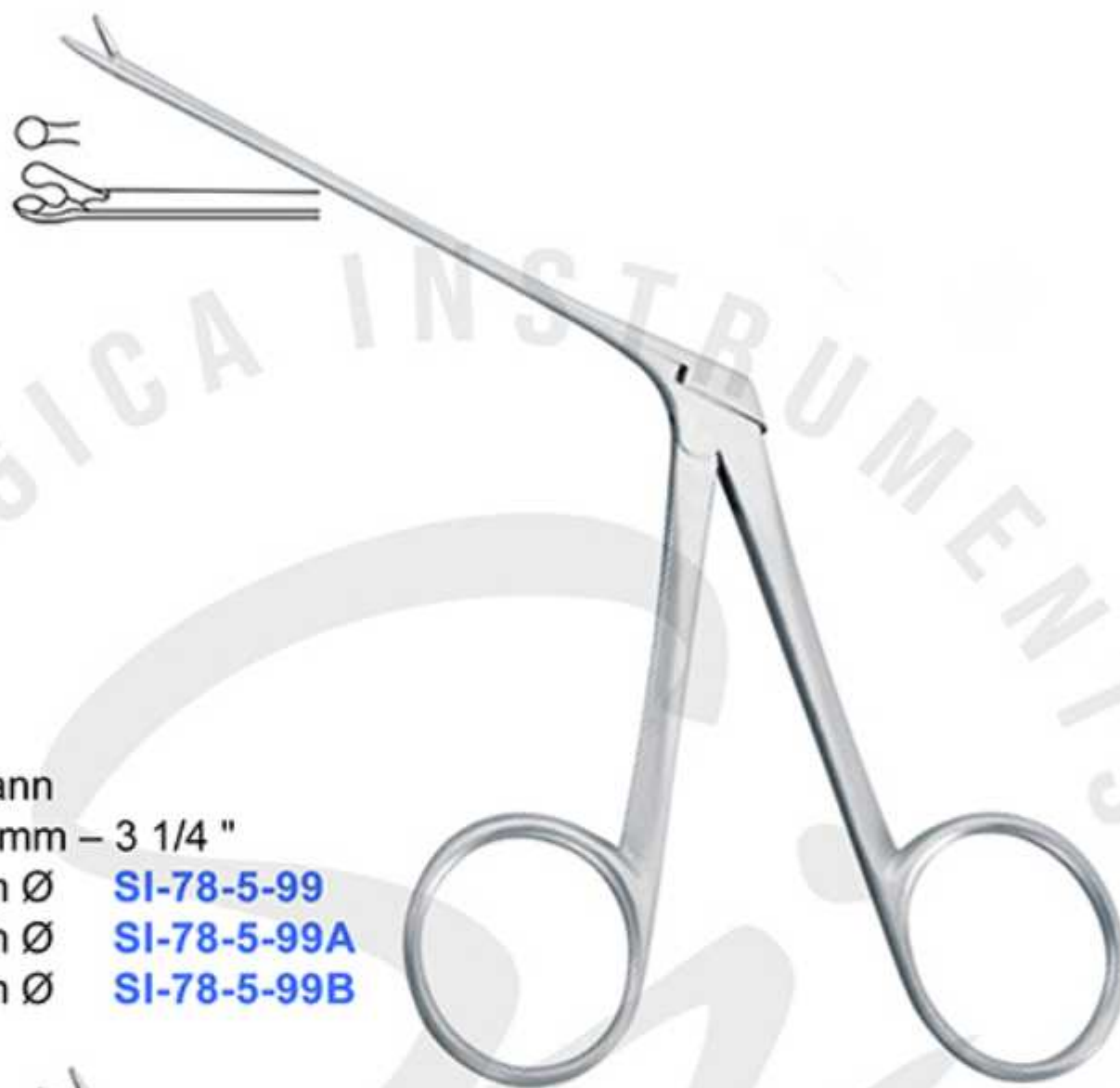

Hartmann
x = 85 mm – 3 1/4 "
2.0 mm Ø **SI-78-5-99**
2.5 mm Ø **SI-78-5-99A**
3.0 mm Ø **SI-78-5-99B**



Struempel
x = 85 mm – 3 1/4 "
SI-78-5-100
0°

Pinces pour polypes auriculaires
Ear polypus forceps
Pinzas para pólipos auriculares
Pinze per polipi auricolari



Struempel
x = 85 mm – 3 1/4 "
SI-78-5-101
45°

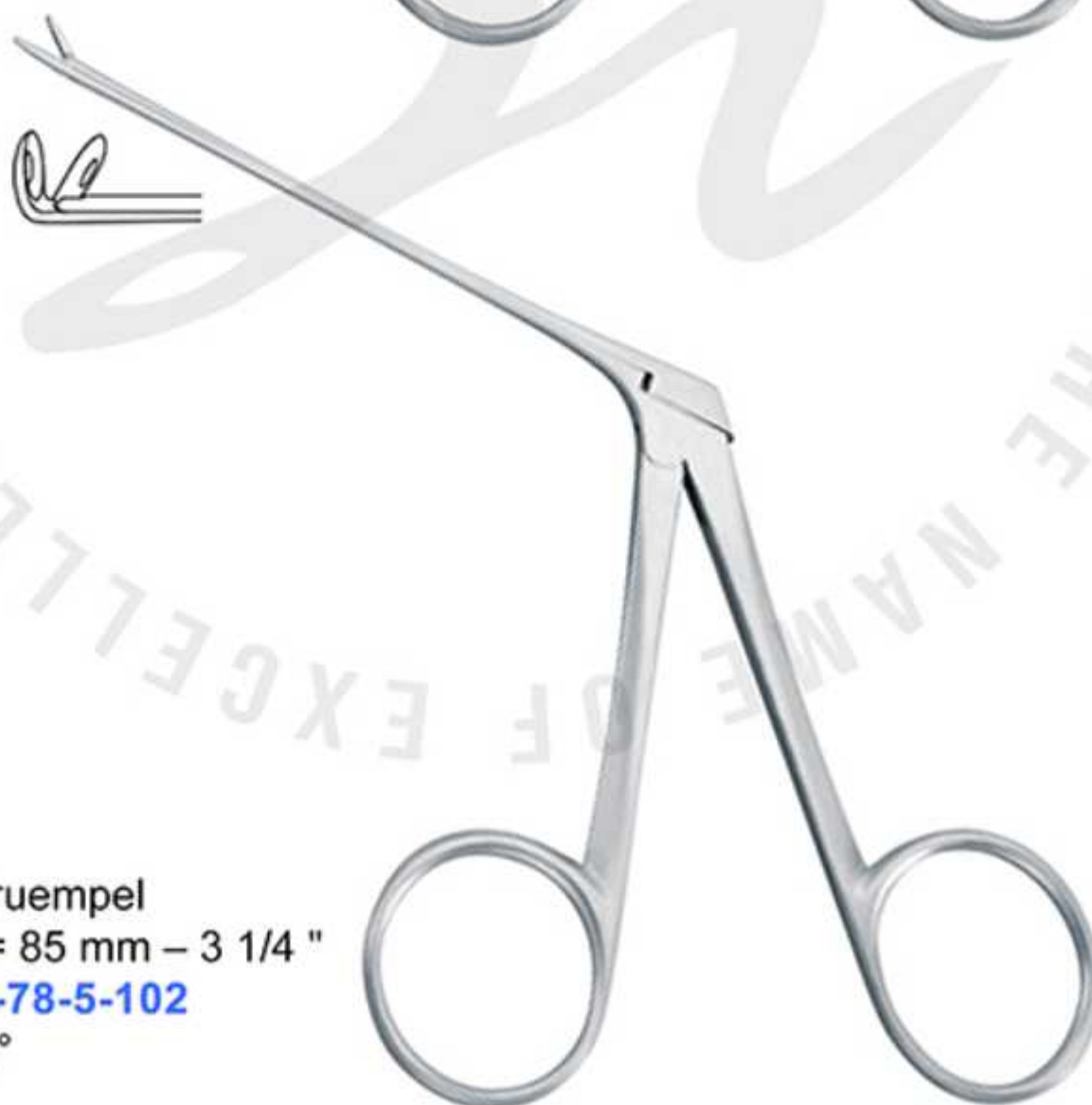

Struempel
x = 85 mm – 3 1/4 "
SI-78-5-102
90°

Pinces pour polypes auriculaires
Ear polypus forceps
Pinzas para pólipos auriculares
Pinze per polipi auricolari

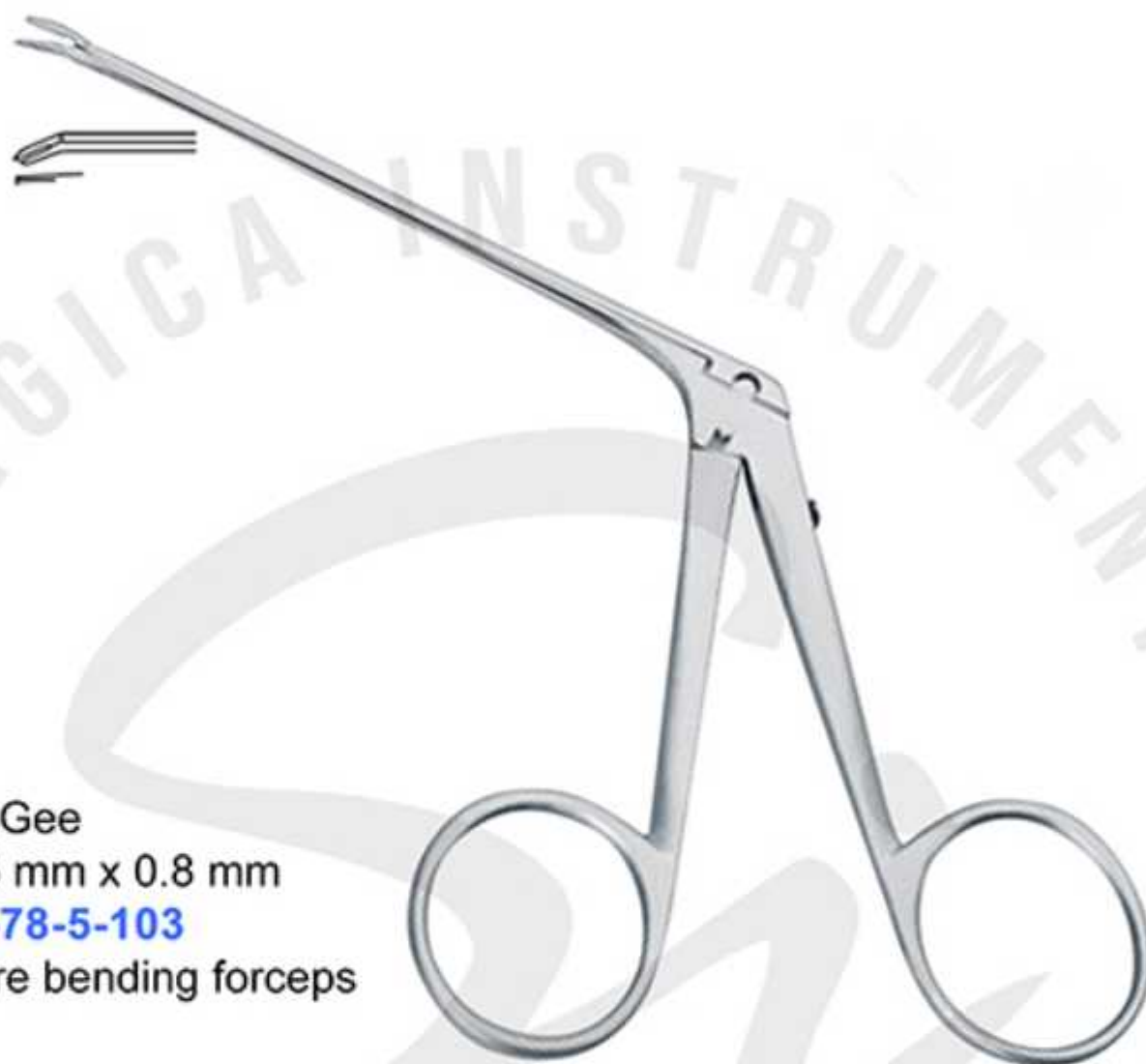

McGee
3.5 mm x 0.8 mm
SI-78-5-103
Wire bending forceps



Fuller
80 mm – 3 1/4 "
SI-78-5-104
Introducing forceps
for teflon prosthesis

Pinces pour polypes auriculaires
Ear polypus forceps
Pinzas para pólipos auriculares
Pinze per polipi auricolari



Dieter
x = 80 mm – 3 1/4 "
SI-78-5-105
Malleus nipper
up-cutting



Dieter
x = 80 mm – 3 1/4 "
SI-78-5-106
Malleus nipper
down-cutting

Pinces pour polypes auriculaires
Ear polypus forceps
Pinzas para pólipos auriculares
Pinze per polipi auricolari



Dieter
x = 80 mm – 3 1/4 "
SI-78-5-107
Malleus nipper
Right-cutting



Dieter
x = 80 mm – 3 1/4 "
SI-78-5-108
Malleus nipper
Left-cutting

Pinces pour polypes auriculaires
Ear polypus forceps
Pinzas para pólipos auriculares
Pinze per polipi auricolari



Mini McGee
3.5 mm x 0.6 mm
x = 75 mm – 3 "
SI-78-5-109
Straight, smooth

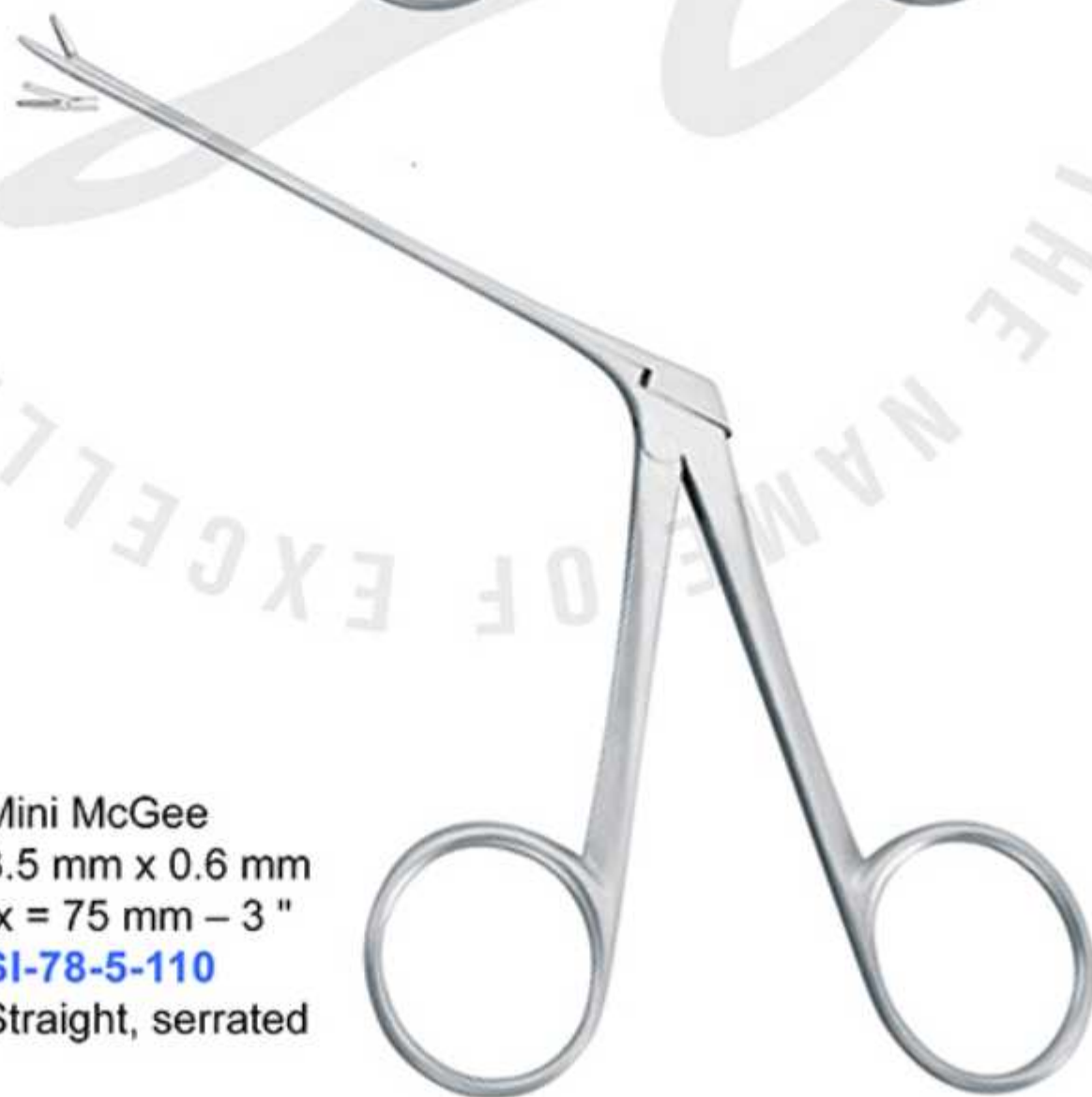

Mini McGee
3.5 mm x 0.6 mm
x = 75 mm – 3 "
SI-78-5-110
Straight, serrated

Pinces pour polypes auriculaires
Ear polypus forceps
Pinzas para pólipos auriculares
Pinze per polipi auricolari

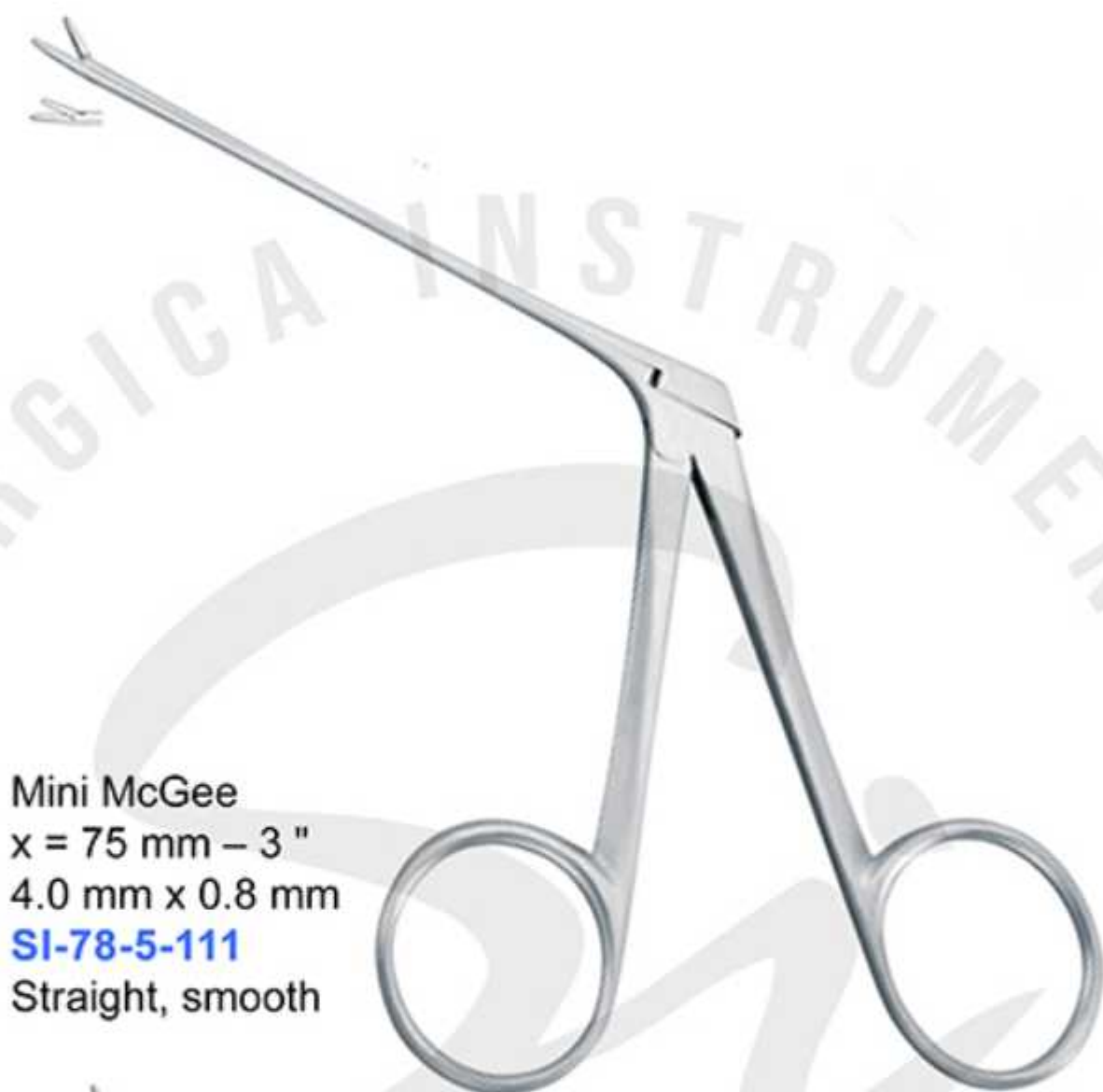

Mini McGee
x = 75 mm – 3 "
4.0 mm x 0.8 mm
SI-78-5-111
Straight, smooth



Mini McGee
x = 75 mm – 3 "
4.0 mm x 0.8 mm
SI-78-5-112
Straight, Serrated

Pinces pour polypes auriculaires
Ear polypus forceps
Pinzas para pólipos auriculares
Pinze per polipi auricolari



Mini McGee
x = 75 mm – 3 "
3.5 mm x 0.6 mm **SI-78-5-113**
4.0 mm x 0.8 mm **SI-78-5-113A**
Curved upwards, serrated



Mini McGee
x = 75 mm – 3 "
3.5 mm x 0.6 mm **SI-78-5-114**
4.0 mm x 0.8 mm **SI-78-5-114A**
Curved to right, serrated

Pinces pour polypes auriculaires
Ear polypus forceps
Pinzas para pólipos auriculares
Pinze per polipi auricolari



Mini McGee
x = 75 mm – 3 "
3.5 mm x 0.6 mm **SI-78-5-115**
4.0 mm x 0.8 mm **SI-78-5-115A**
Curved to left, serrated



Mini McGee
x = 75 mm – 3 "
3.5 mm x 0.6 mm **SI-78-5-116**
4.0 mm x 0.8 mm **SI-78-5-116A**
Angled down, serrated

Micro pinces auriculaires à cuillère
Micro Cup Forceps
Micro-pinzas auriculares a cucharilla
Micro-pinze auricolari a cucchiaio

Micro cup forceps
a=4.0mm
b=1.0mm x c=0.9mm
x = 75 mm – 3 "
SI-78-5-117
Straight, oval



Micro cup forceps
a=4.0mm
b=1.0mm x c=0.9mm
x = 75 mm – 3 "
SI-78-5-118
Curved Upwards, oval



Micro pinces auriculaires à cuillère
Micro Cup Forceps
Micro-pinzas auriculares a cucharilla
Micro-pinze auricolari a cucchiaio

Micro cup forceps
a=4.0mm
b=1.0mm x c=0.9mm
x = 75 mm – 3 "
SI-78-5-119
Curved to Left, oval



Micro cup forceps
a=4.0mm
b=1.0mm x c=0.9mm
x = 75 mm – 3 "
SI-78-5-120
Curved to Right, oval



Micro pinces auriculaires à cuillère
Micro Cup Forceps
Micro-pinzas auriculares a cucharilla
Micro-pinze auricolari a cucchiaio

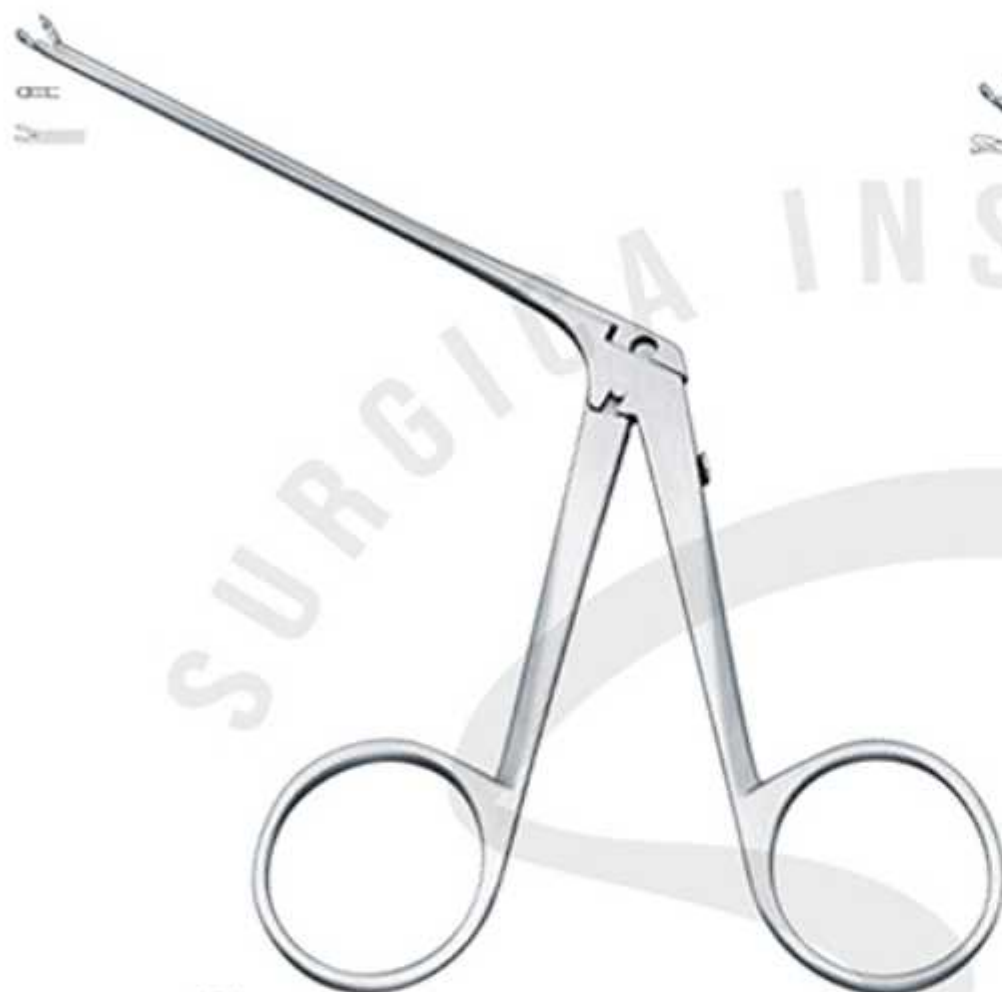

Micro cup forceps
a=3.5mm
b=0.6mm x c=0.5mm
SI-78-5-122
a=4.0mm
b=1.0mm x c=0.9mm
SI-78-5-122A
x = 80 mm – 3 1/4 "
Straight, oval



Micro cup forceps
a=4.0mm
b=1.0mm x c=0.9mm
x = 75 mm – 3 "
SI-78-5-121
Curved Downwards, oval



Micro cup forceps
a=3.5mm
b=0.6mm x c=0.5mm
SI-78-5-123
a=4.0mm
b=1.0mm x c=0.9mm
SI-78-5-123A
x = 80 mm – 3 1/4 "
Curved Upwards, oval

Micro pinces auriculaires à cuillère
Micro Cup Forceps
Micro-pinzas auriculares a cucharilla
Micro-pinze auricolari a cucchiaio

Micro cup forceps
a=3.5mm
b=0.6mm x c=0.5mm
SI-78-5-124
a=4.0mm
b=1.0mm x c=0.9mm
SI-78-5-124A
x = 80 mm – 3 1/4 "
Curved to Right, oval



Micro cup forceps
a=3.5mm
b=0.6mm x c=0.5mm
SI-78-5-125
a=4.0mm
b=1.0mm x c=0.9mm
SI-78-5-125A
x = 80 mm – 3 1/4 "
Curved to Left, oval



Micro ciseaux auriculaires
Micro ear scissors
Micro-tijeras para oídos
Micro-forbici auricolari



Belucci
a x b
4.0 mm x 0.8 mm
x = 75 mm – 3 "
SI-78-5-126
Very fine
Straight, sharp/sharp



Belucci
a x b
4.0 mm x 0.8 mm
x = 75 mm – 3 "
SI-78-5-127
Very fine
Curved upwards, blunt/blunt



Belucci
a x b
4.0 mm x 0.8 mm
x = 75 mm – 3 "
SI-78-5-128
Very fine
Curved to right, sharp/sharp

Micro ciseaux auriculaires
Micro ear scissors
Micro-tijeras para oídos
Micro-forbici auricolari



Belucci
a x b
4.0 mm x 0.8 mm
x = 75 mm – 3 "
SI-78-5-129
Very fine
Curved to Left, sharp/sharp



Belucci
a x b
4.0 mm x 0.8 mm
x = 75 mm – 3 "
SI-78-5-130
Very fine
Straight, sharp/blunt

Micro-curettes auriculaires
Micro ear-spoons
Micro-curetas auriculares
Micro-cucchiai auricolari

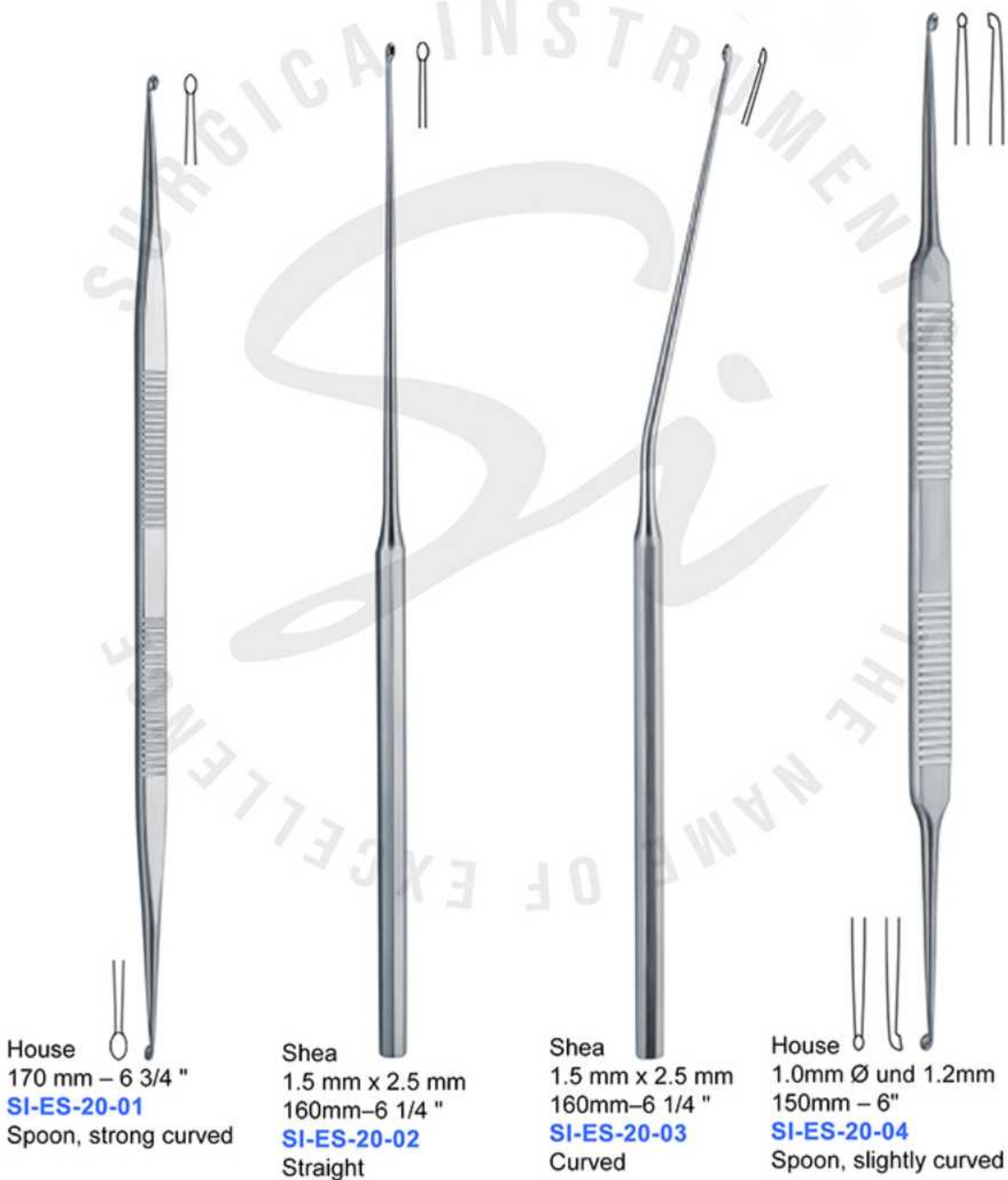

Micro-curettes auriculaires
Micro ear-spoons
Micro-curetas auriculares
Micro-cucchiai auricolari



Micro burins et marteaux auriculaires
Micro ear-chisels and hammers
Micro cincels y martillos para orejas
Micro scalpelli e martelli per orecchio



Raspateurs auriculaires
Ear-raspatories
Raspatorias auriculares
Raspori auricolari



Wullstein
160mm-6 1/4 "
SI-ER-21-01
Straight/Curved



Rosen
1.5 mm
175 mm - 7 "
SI-ER-21-02
Bayonet shaped



Lempert
160mm-6 1/4 "
3.0 mm
SI-ER-21-03

Rongeurs auriculaires
Bone-rongeurs
Pinzas osteótomos auriculares
Conchotomi auricolari

Citelli
170mm
x=60mm

2.2mm
SI-78-5-89

3.0mm
SI-78-5-89A



Kerrison
200 mm
x = 80 mm

3 x 3 mm
SI-78-5-90

4 x 4 mm
SI-78-5-90A

5 x 5 mm
SI-78-5-90B

6 x 6 mm
SI-78-5-90C



Rongeurs auriculaires
Bone-rongeurs
Pinzas osteótomos auriculares
Conchotomi auricolari



Beyer
1 mm
140 mm – 5 1/2 "
SI-78-5-91



Beyer
2 mm
190 mm – 7 1/2 "
SI-78-5-92

Spéculums nasaux
Nasal specula
Especulos nasales
Specoli nasali



Thudichum (Goldsmith)
65 mm – 2 1/2 "



Fig. 5
19 mm x 9.5 mm
SI-NS-22-01



Fig. 6
20 mm x 10.5 mm
SI-NS-22-02



Fig. 7
21 mm x 11.5 mm
SI-NS-22-03



Hartmann
160mm–6 1/4 "



SI-NS-22-04



SI-NS-22-05

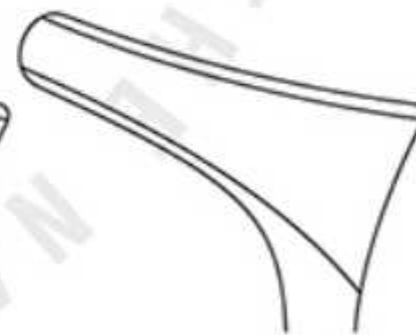

SI-NS-22-06

Spéculums nasaux
Nasal specula
Especulos nasales
Specoli nasali



Hartmann-Halle
150 mm – 6 "

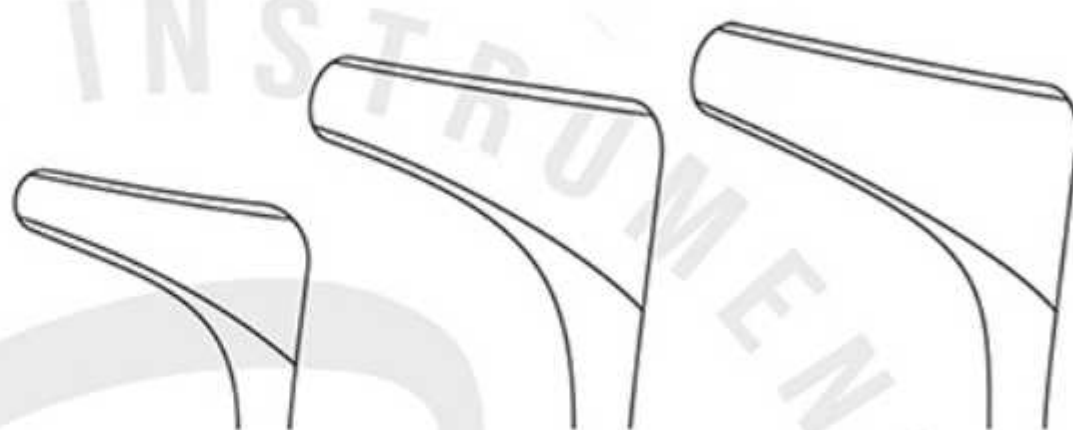

SI-NS-22-07

SI-NS-22-08

SI-NS-22-09



Tieck-Halle
135mm– 5 1/4 "
SI-NS-22-10
For babies



Schwarz
140 mm – 5 1/2 "
SI-NS-22-11

Spéculums nasaux
Nasal specula
Especulos nasales
Specoli nasali



Killian
130 mm – 5 "

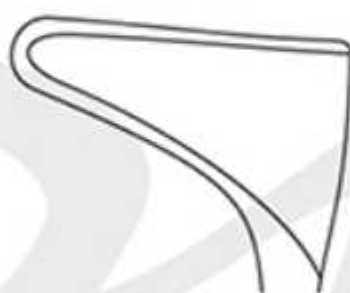

x = 35 mm
SI-NS-22-12



x = 50 mm
SI-NS-22-13

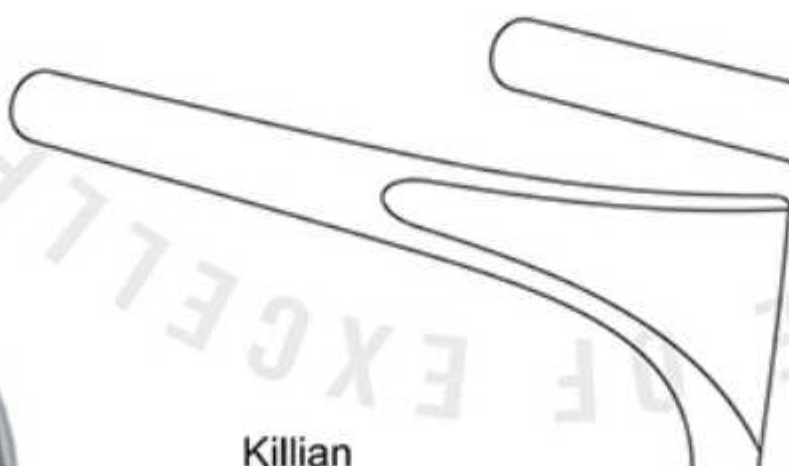

Killian
130 mm – 5 "

x = 75 mm
SI-NS-22-14



x = 90 mm
SI-NS-22-15

Spéculums nasaux
Nasal specula
Especulos nasales
Specoli nasali



Beckmann
150 mm – 6 "

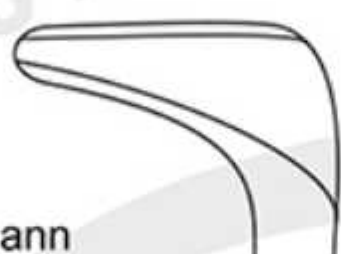

SI-NS-22-16



SI-NS-22-17

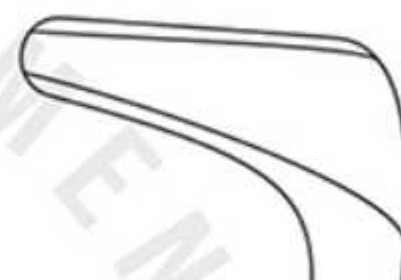

SI-NS-22-18



Mod. Wien
145mm–5 3/4 "

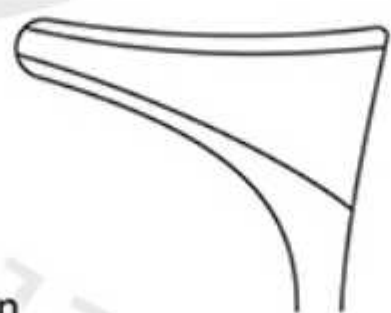

SI-NS-22-19

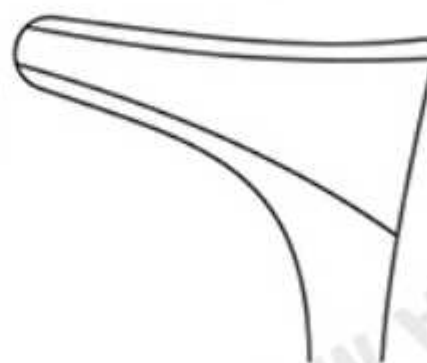

SI-NS-22-20

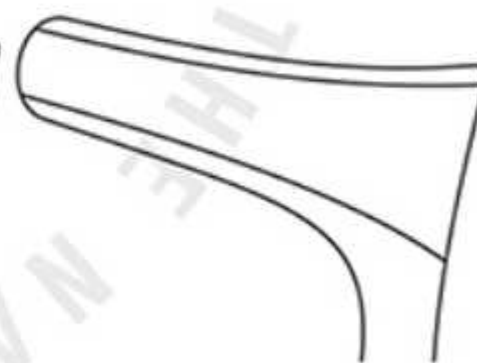

SI-NS-22-21

Spéculums nasaux
Nasal specula
Especulos nasales
Specoli nasali



Cottle
150 mm – 6"



x = 35 mm
SI-NS-22-22

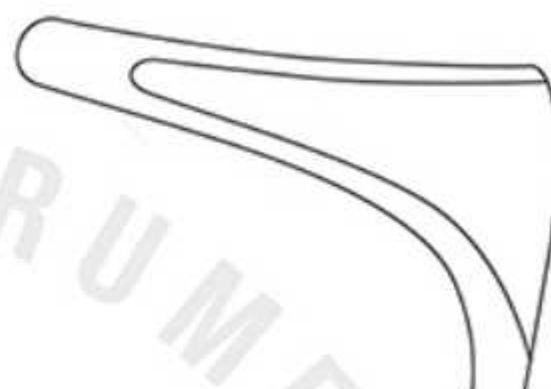

x = 50 mm
SI-NS-22-23

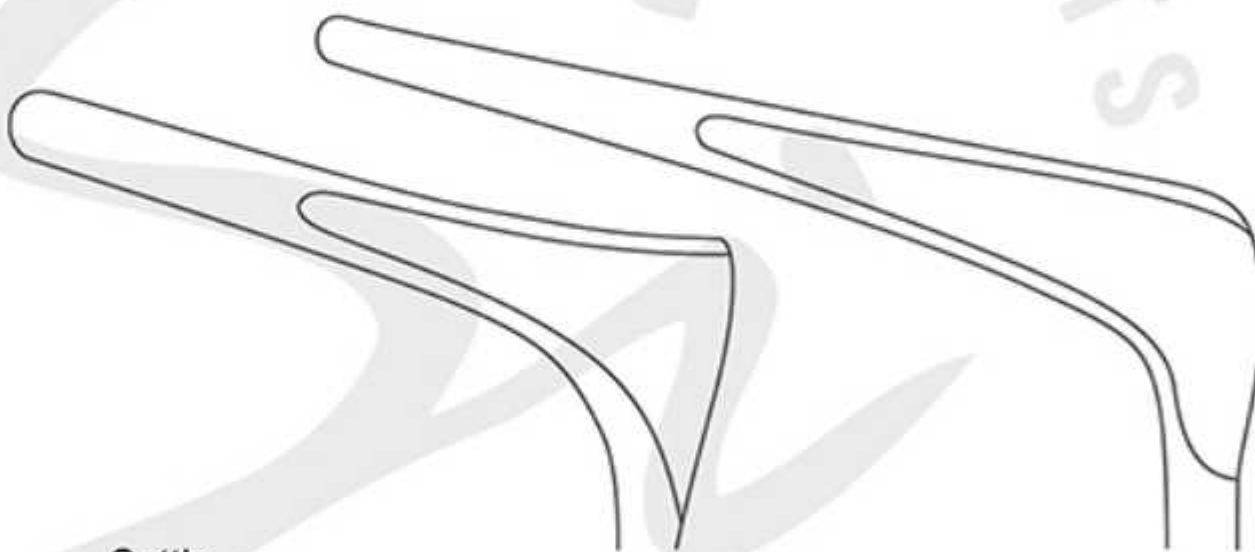

Cottle
150 mm – 6"

x = 75 mm
SI-NS-22-24

x = 90 mm
SI-NS-22-25



Cottle
140mm–5 1/2"
Black, chrome plated



x = 45 mm
SI-NS-22-26



x = 75 mm
SI-NS-22-27

Pinces coupantes pour le nez
Nasal cutting forceps
Pinzas nasales cortantes
Pinze taglianti per naso



Luc
200 mm
Fenestrated



Fig. 1

SI-NF-23-01

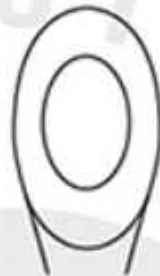

Fig. 2

SI-NF-23-01



Fig. 1

SI-NF-23-03

Plaine



Fig. 2

SI-NF-23-04



Takahashi

x=120mm

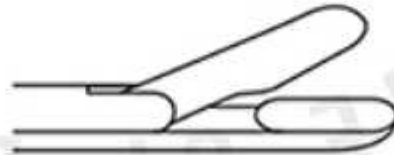

3.5 mm x 10 mm

SI-NF-23-05



3.5 mm x 10 mm

SI-NF-23-06

Pinces coupantes pour le nez
Nasal cutting forceps
Pinzas nasales cortantes
Pinze taglianti per naso



Bruenings
190 mm – 7 1/2 "



SI-NF-23-07



SI-NF-23-08



SI-NF-23-09



SI-NF-23-10



x=120mm



Weil
SI-NF-23-11



Watson-Williams
SI-NF-23-12



SI-NF-23-13

Pinces coupantes pour le nez
Nasal cutting forceps
Pinzas nasales cortantes
Pinze taglianti per naso

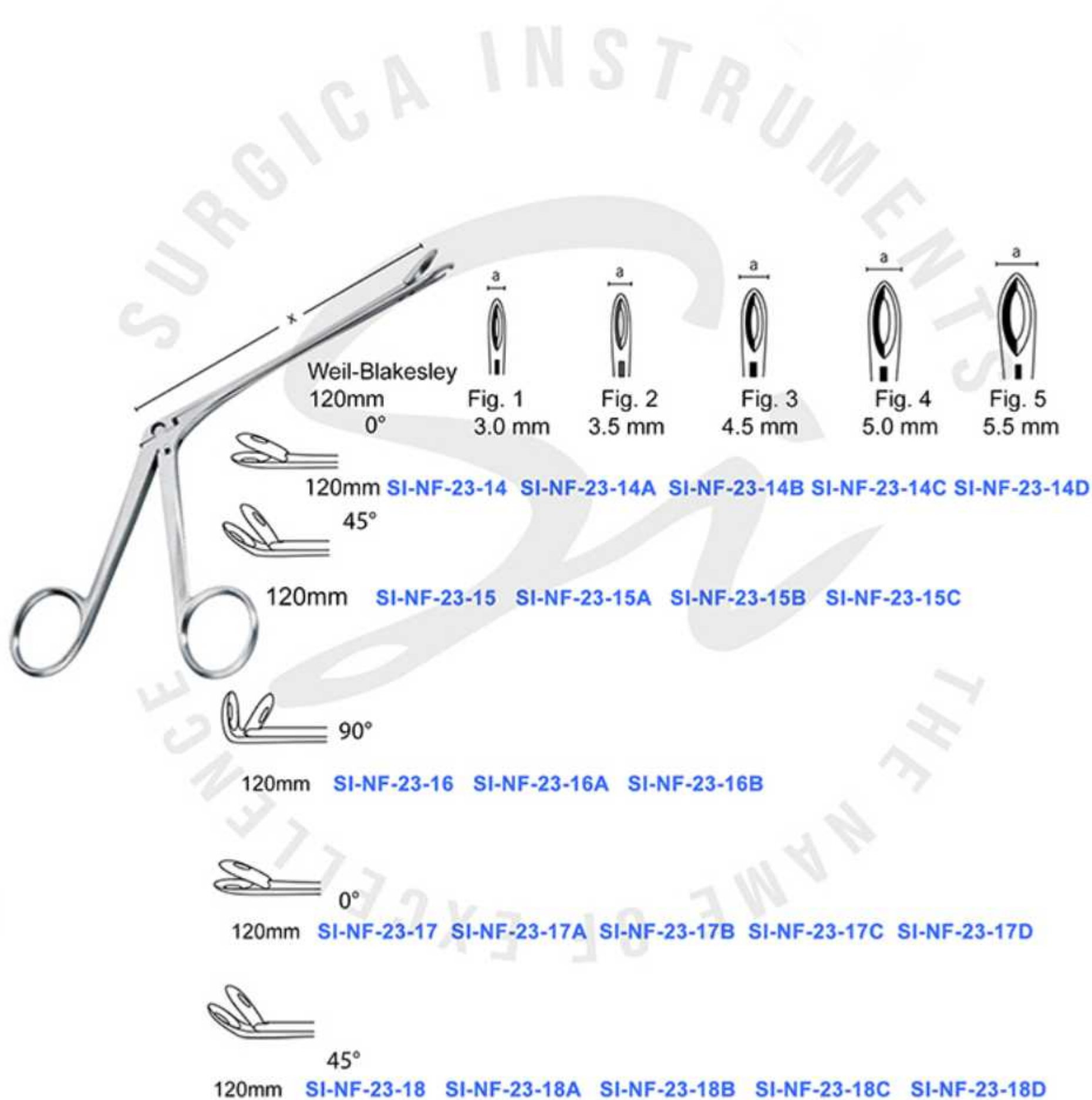

Pinces coupantes pour le nez
Nasal cutting forceps
Pinzas nasales cortantes
Pinze taglianti per naso



Hartmann
x=120mm

SI-NF-23-19

SI-NF-23-20

SI-NF-23-21

SI-NF-23-22

Myles



Fig. 1

2.0 x 10.0 mm
SI-NF-23-23

Fig. 2

2.5 x 12.0 mm
SI-NF-23-24

Fig. 3

3.0 x 14.0 mm
SI-NF-23-25

x=120mm



Schmeden
x=120mm - 4 3/4 "

SI-NF-23-26

SI-NF-23-26A

SI-NF-23-26B

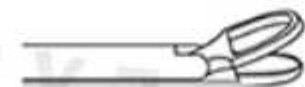

Tomati
x=120mm - 4 3/4 "
SI-NF-23-27



Struycken

120mm

0.9 mm
SI-NF-23-28

1.2 mm
SI-NF-23-28A



Henke
x=120mm - 4 3/4 "
SI-NF-23-29

Pinces pour le sinus sphénoïdal
Sphenoid bone punches
Pinzas para esfenoïdes
Pinze sfenoïdali taglianti

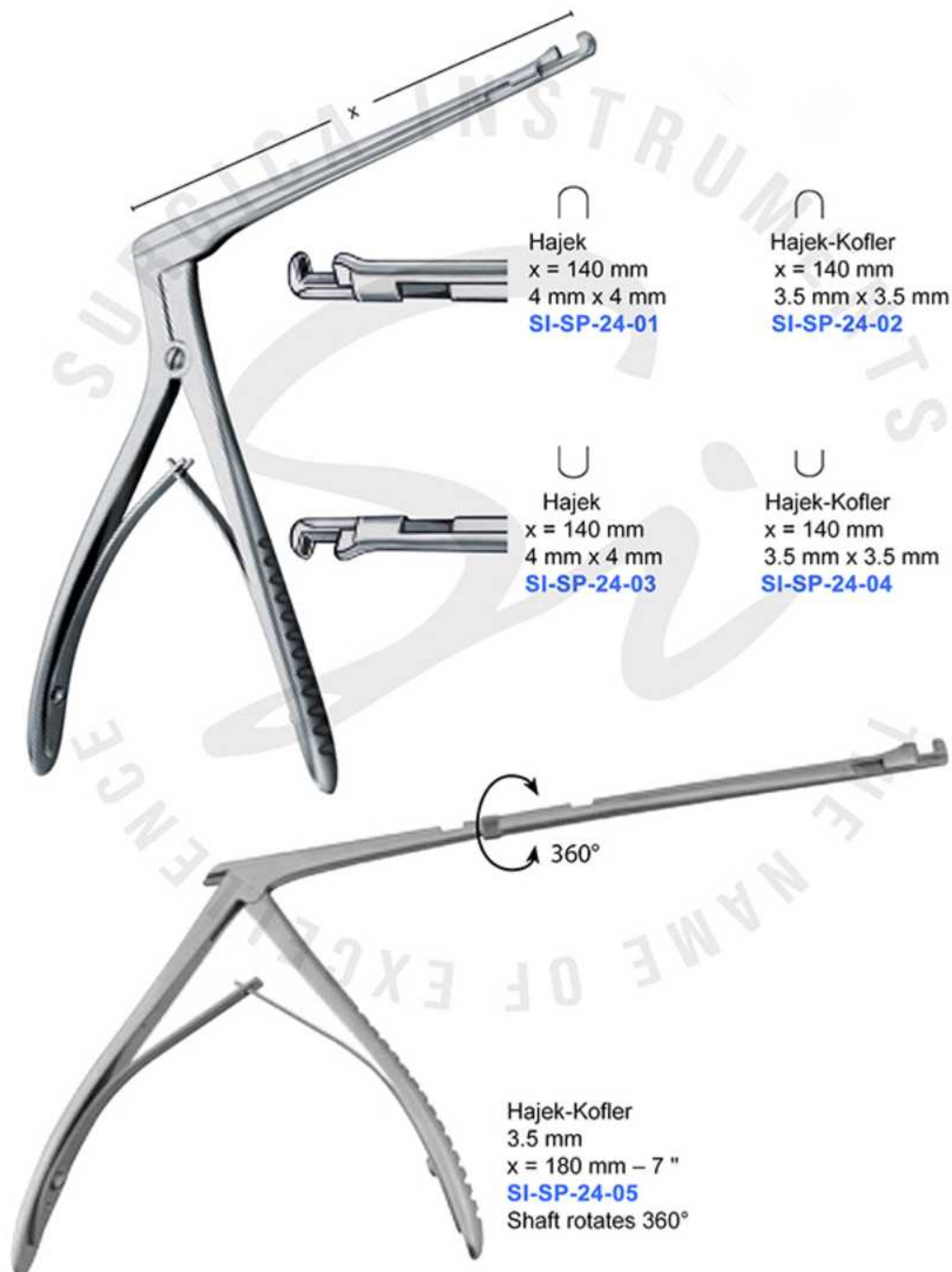

Pinces pour le sinus sphénoïdal
Sphenoid bone punches
Pinzas para esfenoïdes
Pinze sfenoïdali taglianti



Hajek-Claus
200 mm – 8"
SI-SP-24-06

Citelli
170mm
x=60mm

2.2mm
SI-SP-24-07

3.0mm
SI-SP-24-07A



Kerrison

x = 90 mm
200 mm

4 mm x 4 mm
SI-SP-24-08

5 mm x 5 mm
SI-SP-24-09

6 mm x 6 mm
SI-SP-24-10

Serre noeuds pour polypes
Nasal polypus snares
Polipótomos nasales
Serranodi nasali

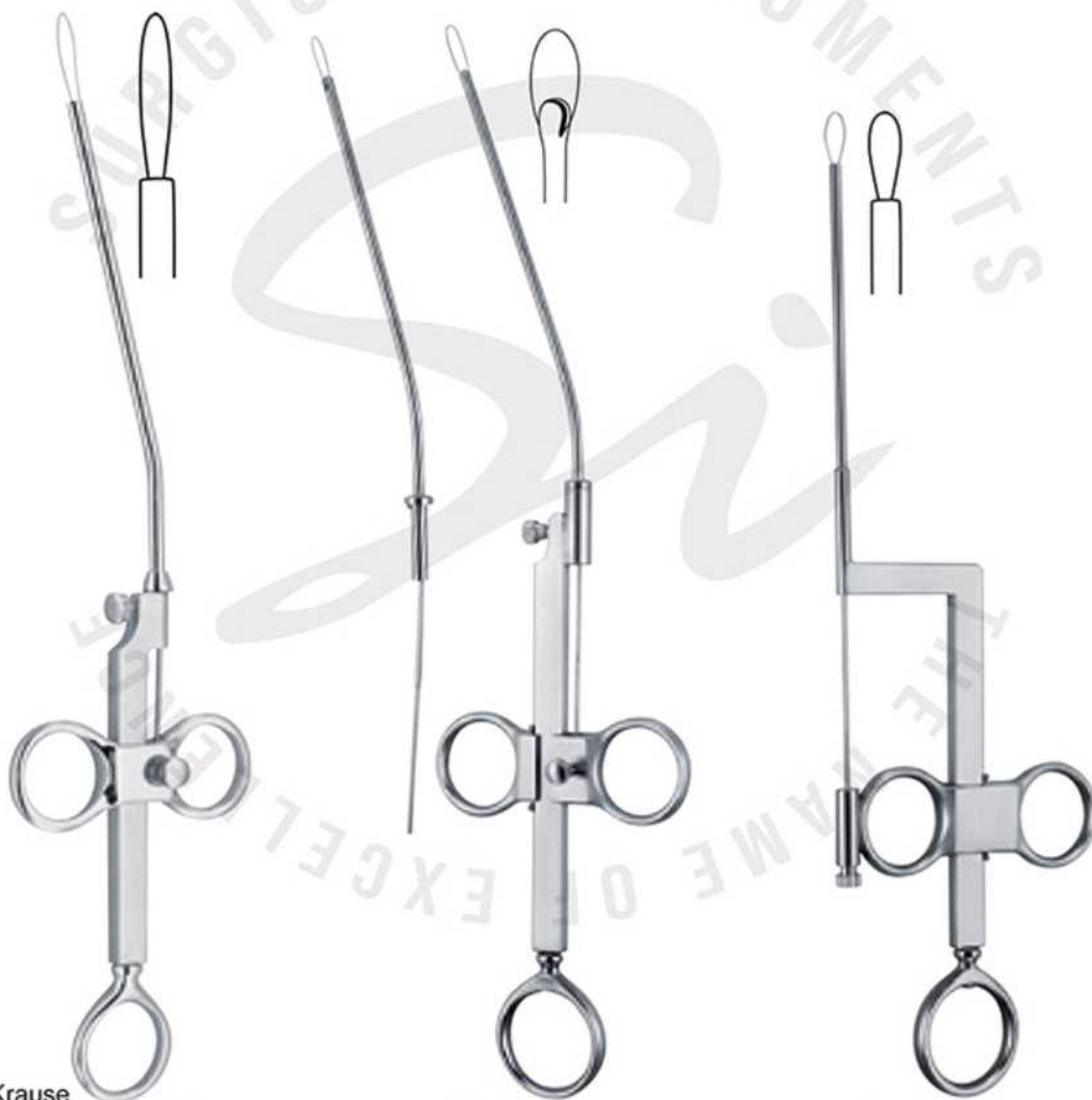

Krause
260 mm – 10 1/4 "
SI-NPS-01

Krause-Voss
260 mm – 10 1/4 "
SI-NPS-02
with 2 inserts

Lange-Wilde
240 mm – 9 1/2 "
SI-NPS-03

ENT INSTRUMENTS

Bistouris pour nez
Nasal knives
Cuchillos nasales
Bisturi per naso



Joseph
160 mm
Sharp/Sharp

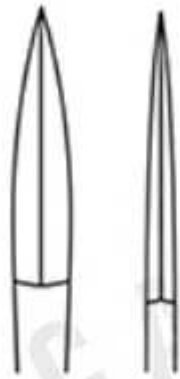

Fig. 1
SI-NK-25-02
Straight



Fig. 2
SI-NK-25-03
Straight



Fig. 1
SI-NK-25-04
Curved



Fig. 2
SI-NK-25-05
Curved



Fomon
165 mm – 6 1/2 "
SI-NK-25-01



Joseph
140 mm – 5 1/2 "
SI-NK-25-06



Cottle
150 mm – 6 "
SI-NK-25-07

Bistouris pour nez
Nasal knives
Cuchillos nasales
Bisturi per naso



Joseph
175 mm – 7 "
SI-NK-25-08



Bruenings
165 mm – 6 1/2 "
SI-NK-25-09



Freer
190 mm – 6 1/2 "
SI-NK-25-10



Freer
190 mm – 6 1/2 "
SI-NK-25-11

Bistouris pour nez
Nasal knives
Cuchillos nasales
Bisturi per naso



Converse
160mm-6 1/4 "
SI-NK-25-12



Freer
150 mm - 6 "
SI-NK-25-13



Freer
150 mm - 6 "
SI-NK-25-14



Freer
150 mm - 6 "
SI-NK-25-15

Couteaux à tonsils
Tonsil knives
Bisturis para amigdales
Bisturi per tonsille



Freer
210mm-8 1/4 "
SI-TK-26-01



Freer
210mm-8 1/4 "
SI-TK-26-02



Sickle knife
200 mm – 8 "
SI-TK-26-03



Bruenings
230 mm – 9 "
SI-TK-26-04

Couteaux à tonsils
Tonsil knives
Bisturis para amigdales
Bisturi per tonsille



Abraham
220mm-8 3/4 "
SI-TK-26-05

Fischer
230 mm - 9 "
SI-TK-26-06

Tonsil Knife
200 mm - 8 "
SI-TK-26-07
Sharp

Curettes d'antrum
Antrum curettes
Curetas para el antrum
Curette per antrum

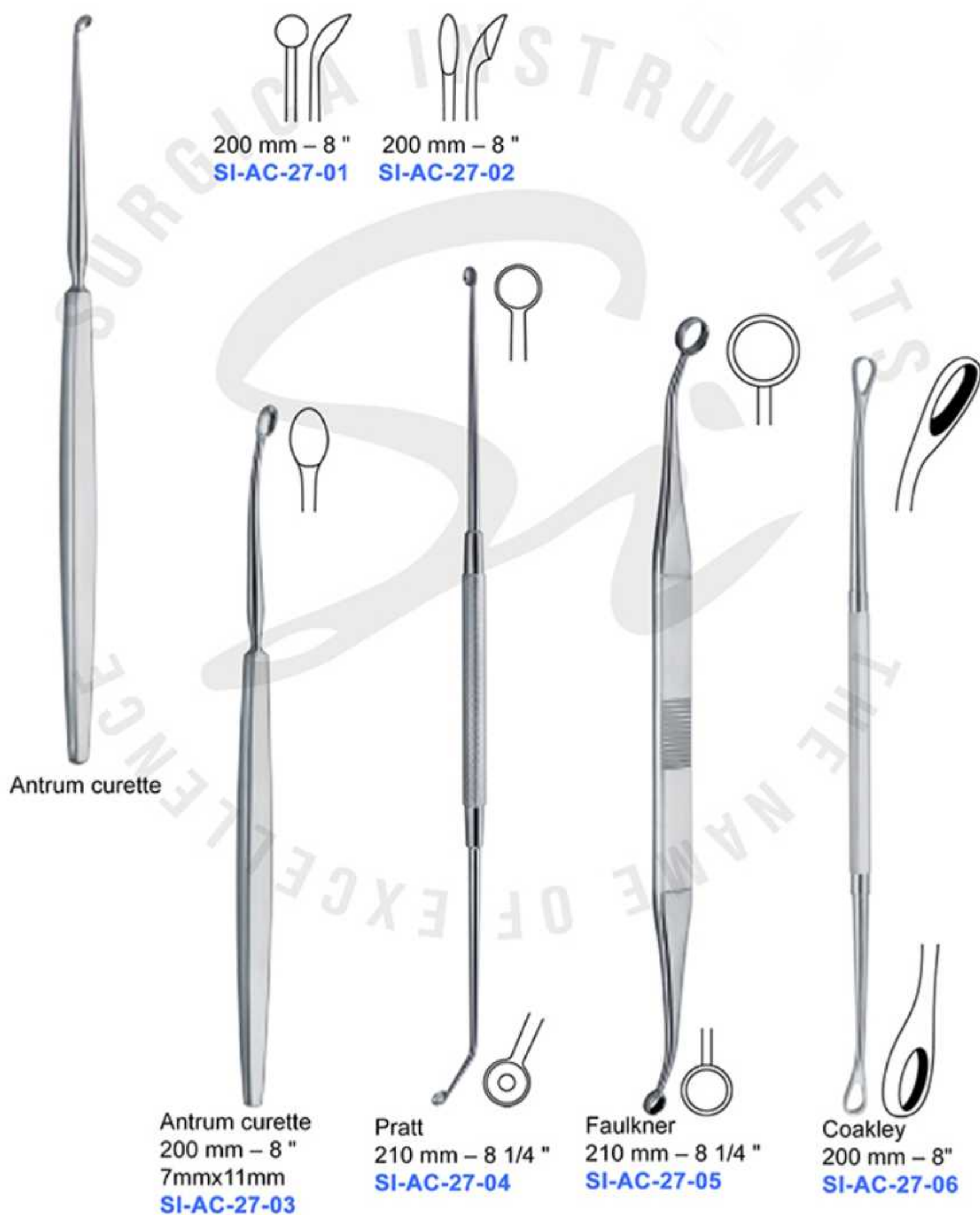

Curettes d'antrum
Antrum curettes
Curetas para el antrum
Curette per antrum

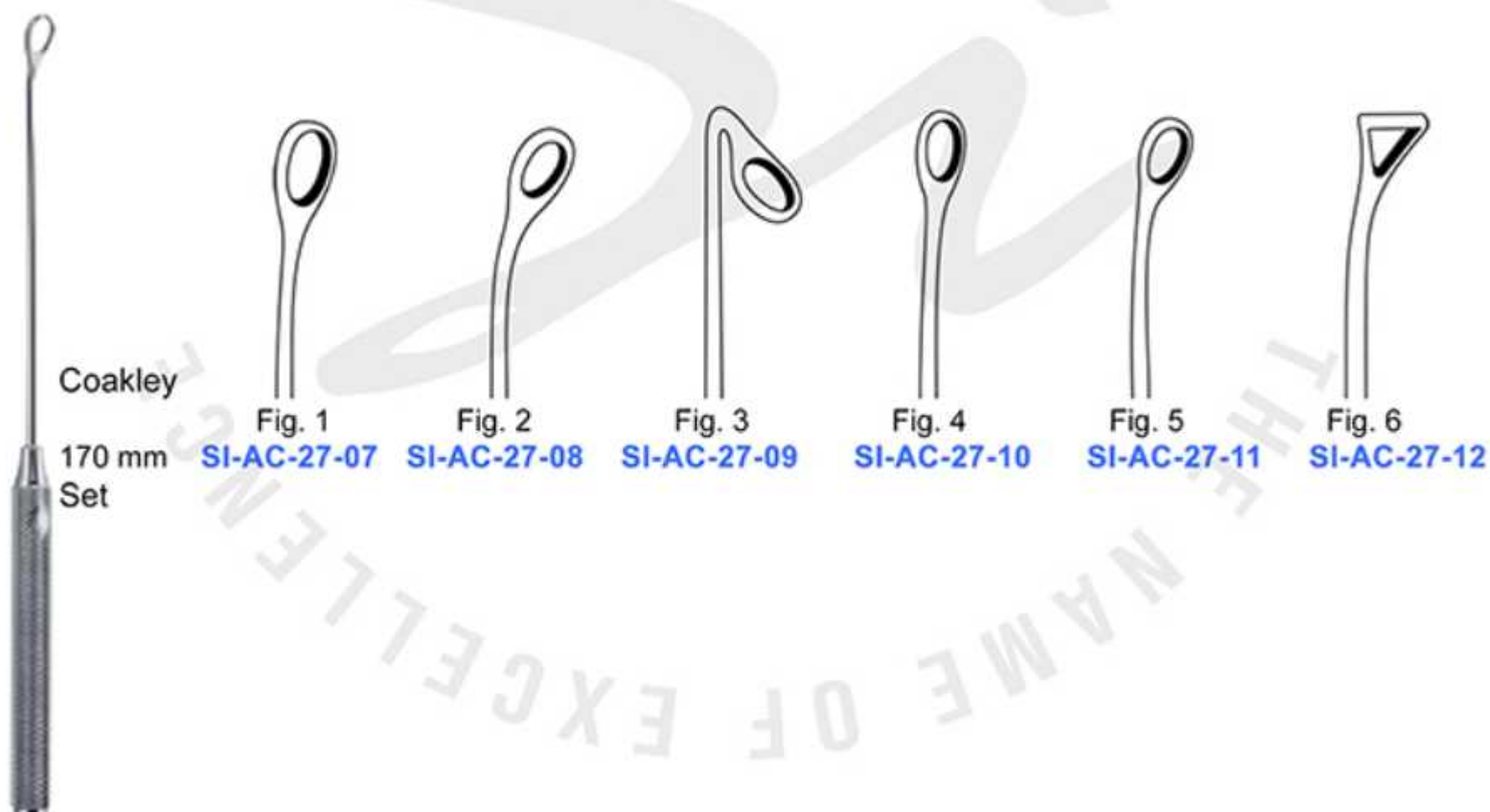

Elevateurs – rugines pour la cloison nasale
Septum elevators – raspatories
Elevadores – legras para el tabique nasal
Elevatori – periostotomi per setto

Lempert
205 mm – 8 "
x = 6 mm
SI-78-5-149



Lempert
180 mm – 7 "
x = 6 mm
SI-78-5-150



Freer
160 mm – 6 1/4 "
x = 4 mm
SI-78-5-151



Cottle
190 mm – 7 1/2 "
x = 8 mm
SI-78-5-152
Sharp



Elevateurs – rugines pour la cloison nasale
Septum elevators – raspatories
Elevadores – leguas para el tabique nasal
Elevatori – periostotomi per setto



Joseph
160 mm – 6 1/4 "
x = 5 mm
SI-78-5-153
Periosteal elevators



Sewall
200 mm – 8 "
SI-78-5-154
Antrum elevator



Halle
160 mm – 6 1/4 "
SI-78-5-155



McKenty
150 mm – 6 "
4 mm
SI-78-5-156
Sharp

Elevateurs – rugines pour la cloison nasale
Septum elevators – raspatories
Elevadores – legras para el tabique nasal
Elevatori – periostotomi per setto



McKenty
150 mm – 6 "
5 mm
SI-78-5-157
Sharp



McKenty
205 mm – 8 "
x = 4 mm
SI-78-5-158
Sharp



Killian
180 mm – 7 "
x = 4 mm
SI-78-5-159
Sharp/Blunt



Killian
230 mm – 9 "
x = 4.5 mm
SI-78-5-160
Sharp/Blunt

Elevateurs – rugines pour la cloison nasale
Septum elevators – raspatories
Elevadores – legras para el tabique nasal
Elevatori – periostotomi per setto



Freer
190 mm – 7 1/2 "
SI-78-5-161
Blunt



Freer
180 mm – 7 "
SI-78-5-162
Sharp/Blunt



Freer
205 mm – 8 "
SI-78-5-163
Sharp/Blunt



Pennington
215 mm – 8 1/2 "
SI-78-5-164
Blunt

Elevateurs – rugines pour la cloison nasale
Septum elevators – raspatories
Elevadores – leguas para el tabique nasal
Elevatori – periostotomi per setto



Joseph-Masing
215 mm – 8 1/2 "
SI-78-5-165
Sharp

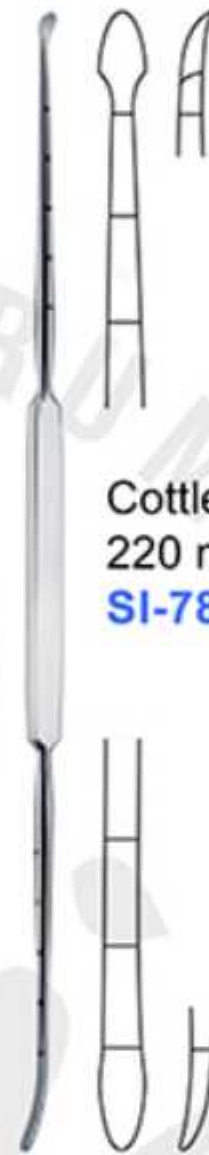

Cottle
220 mm – 8 3/4 "
SI-78-5-166



Cottle
210 mm – 8 1/4 "
SI-78-5-167



Boies
190 mm – 7 1/2 "
SI-78-5-168
Nasal fracture elevator
Blunt

Elevateurs – rugines pour la cloison nasale
Septum elevators – raspatories
Elevadores – legras para el tabique nasal
Elevatori – periostotomi per setto



Goldman
170 mm – 6 3/4 "
SI-78-5-169
Septum displacer



Watson-Cheyne
130 mm – 5 "
SI-78-5-170
Raspatory

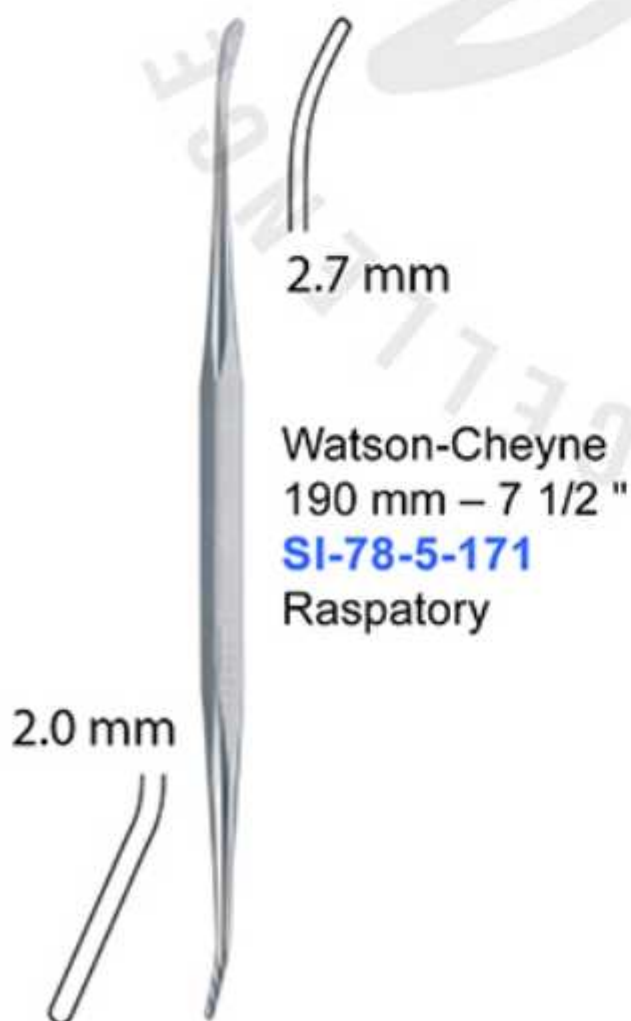

Watson-Cheyne
190 mm – 7 1/2 "
SI-78-5-171
Raspatory



Septum Elevator
195mm – 8 3/4 "
Ø2.3/2.6mm
SI-78-5-172

Scies nasales
Nasal saws
Sierras nasales
Seghe nasali



Joseph
190 mm – 7 1/2 "
SI-78-5-144



Joseph
190 mm – 7 1/2 "
SI-78-5-145



Joseph
190 mm – 7 1/2 "
SI-78-5-146



Joseph
170 mm – 6 3/4 "
SI-78-5-147



Joseph
170 mm – 6 3/4 "
SI-78-5-148

Râpes nasales
Nasal rasps
Limas nasales
Raspe nasali



Cottle
210 mm – 8 1/4 "
SI-78-5-131

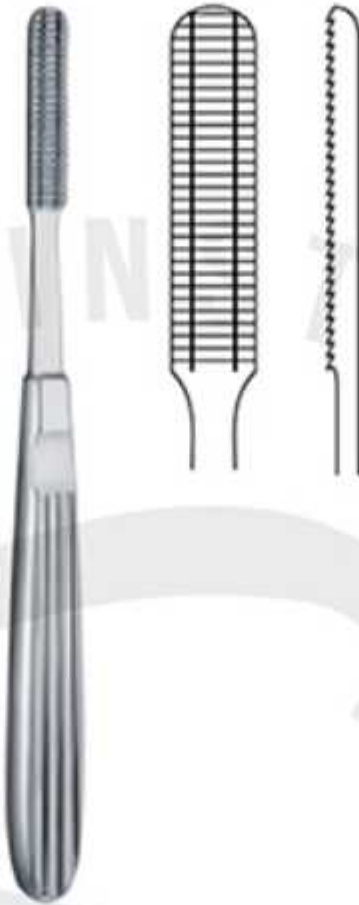

Maltz
170 mm – 6 3/4 "
34 mm x 7 mm
SI-78-5-132
Drawing cut

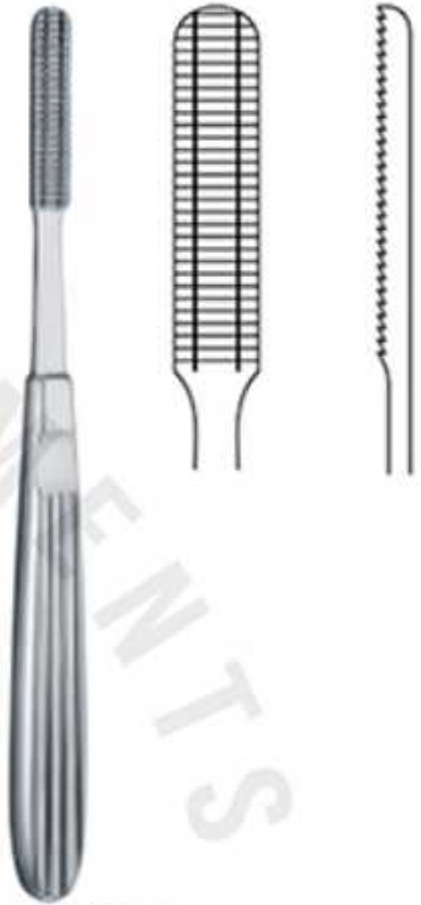

Maltz
170 mm – 6 3/4 "
34 mm x 7 mm
SI-78-5-133
Pushing cut



Aufricht
210 mm – 8 1/4 "
SI-78-5-134
Pushing cut



Aufricht
210 mm – 8 1/4 "
SI-78-5-135
Drawing cut

Râpes nasales
Nasal rasps
Limas nasales
Raspe nasali

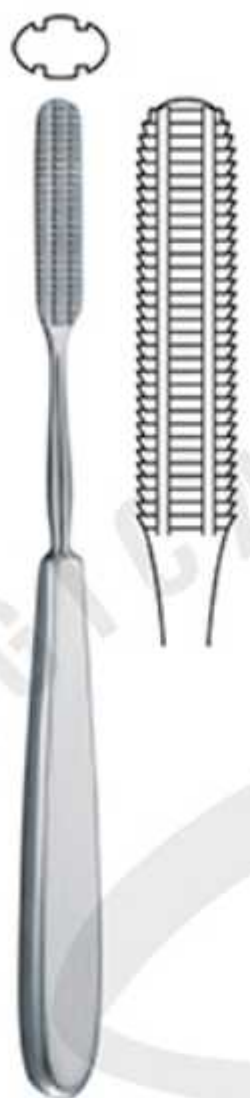

Maltz
175 mm – 7 "
40 mm x 9 mm
SI-78-5-136



Wiener
3.5 mm Ø
180 mm – 7 "
SI-78-5-137
Antrum rasps



Wiener
3.5 mm Ø
180 mm – 7 "
SI-78-5-138
Antrum rasps



Gallaher
160 mm – 6 1/4 "
SI-78-5-139
Straight

Râpes nasales
Nasal rasps
Limas nasales
Raspe nasali



Gallaher
160 mm – 6 1/4 "
SI-78-5-140
Left



Gallaher
160 mm – 6 1/4 "
SI-78-5-141
Right



Fomon
210 mm – 8 1/4 "
SI-78-5-142



Fomon
210 mm – 8 1/4 "
SI-78-5-143

Râpes avec inserts de carbure de tungstène
Rasps with tungsten carbide
Limas con carburo de tungsteno
Raspe con tungsteno

Fomon

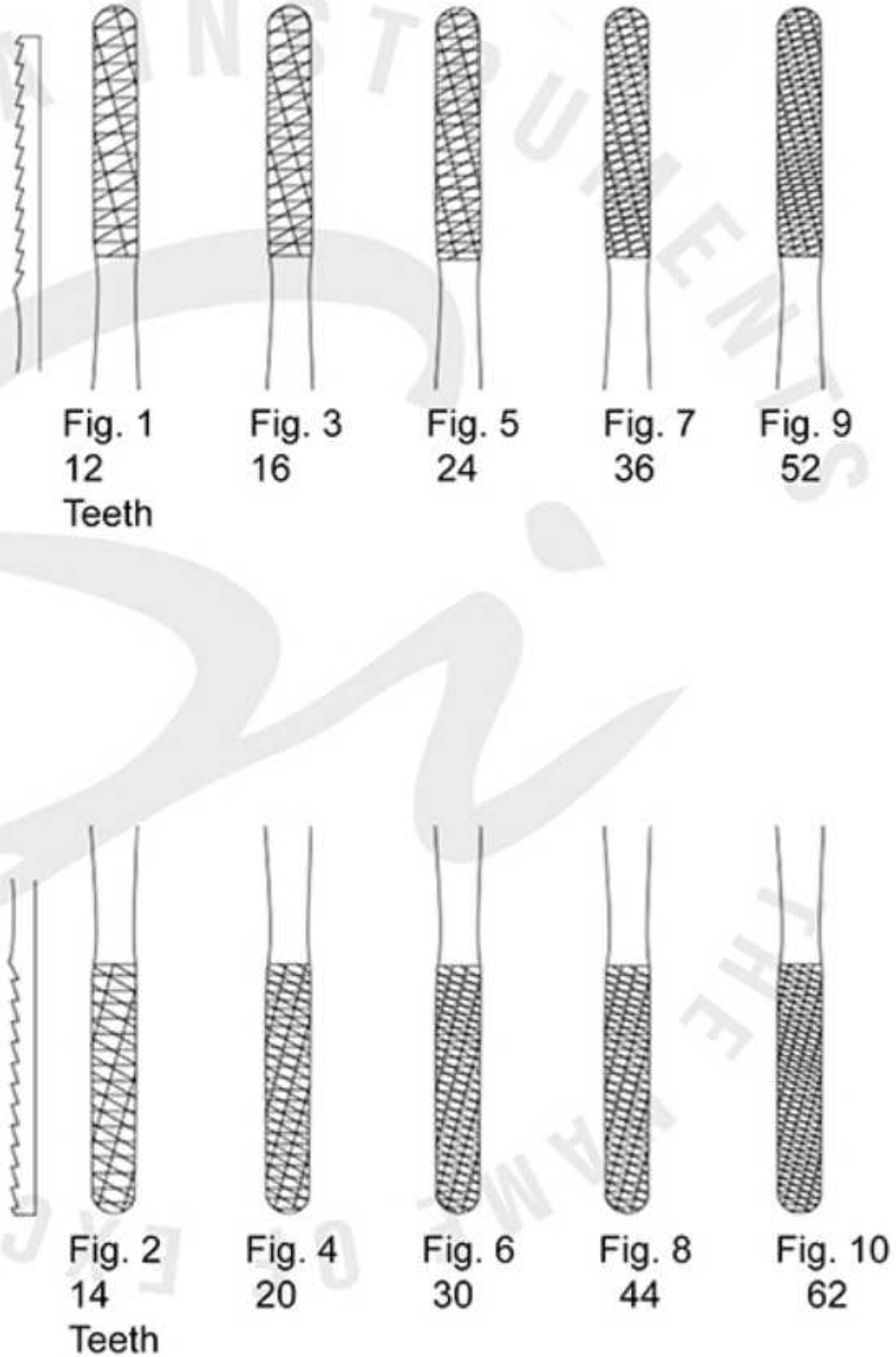

Fomon TC

200 mm – 8"

Fig. 1 & Fig. 2

Fig. 3 & Fig. 4

Fig. 5 & Fig. 6

Fig. 7 & Fig. 8

Fig. 9 & Fig. 10

SI-78-5-44

SI-78-5-45

SI-78-5-46

SI-78-5-47

SI-78-5-48

Râpes avec inserts de carbure de tungstène
Rasps with tungsten carbide
Limas con carburo de tungsteno
Raspe con tungsteno

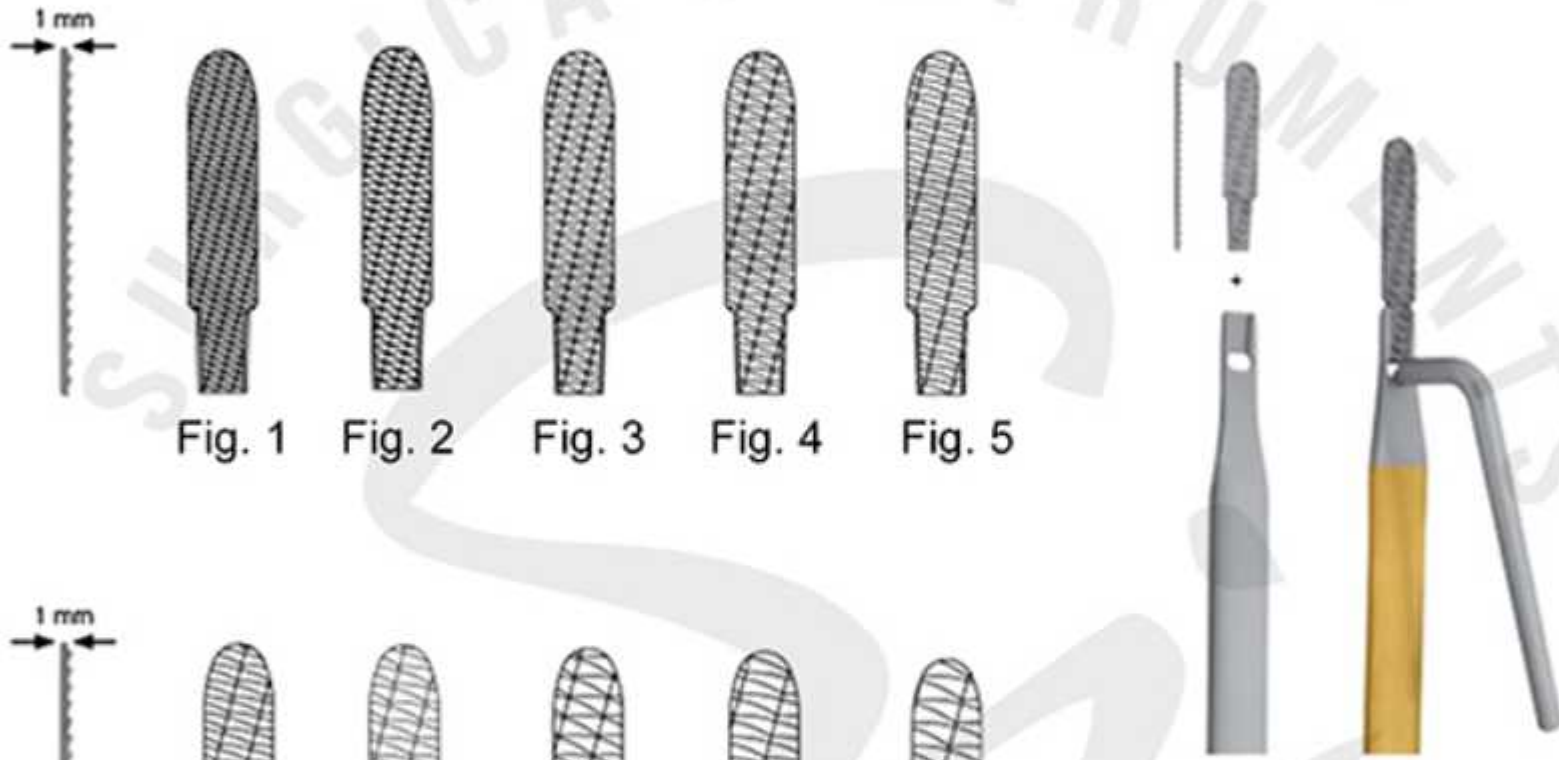

Fig. 1 Fig. 2 Fig. 3 Fig. 4 Fig. 5

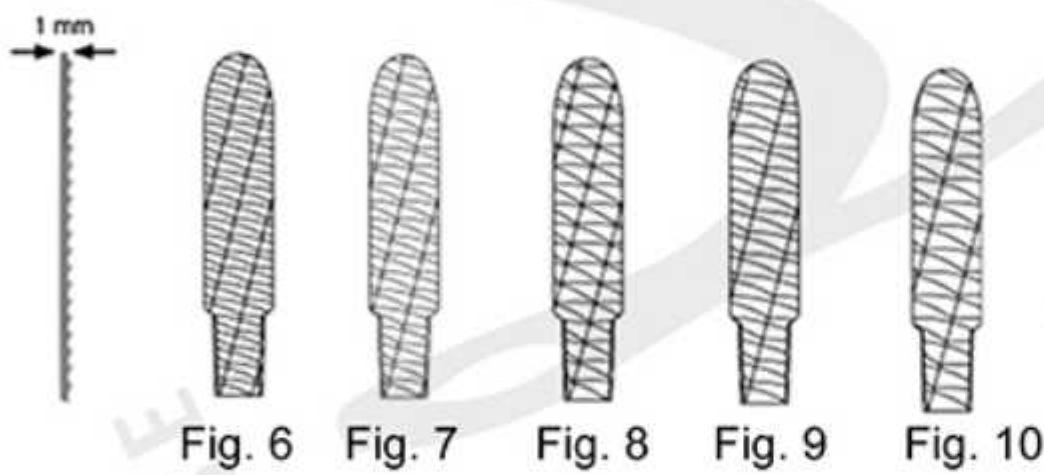

Fig. 6 Fig. 7 Fig. 8 Fig. 9 Fig. 10

Interchangeable

- Fig. 1 **SI-78-5-49**
- Fig. 2 **SI-78-5-50**
- Fig. 3 **SI-78-5-51**
- Fig. 4 **SI-78-5-52**
- Fig. 5 **SI-78-5-53**
- Fig. 6 **SI-78-5-54**
- Fig. 7 **SI-78-5-55**
- Fig. 8 **SI-78-5-56**
- Fig. 9 **SI-78-5-57**
- Fig. 10 **SI-78-5-58**



135 mm – 5"
SI-78-5-58A
SI-78-5-58B



70 mm – 2¾"
SI-78-5-58C

Instruments pour la cloison nasal
Septum instruments
Instrumentos para el tabique nasal
Strumenti per il setto nasale



Bruenings-Brunk
190 mm – 7 1/2 "
SI-78-5-66
Antrum retractor, serrated



Ritter-Halle
160 mm – 6 1/4 "
2.5 mm Ø **SI-78-5-67**
3.0 mm Ø **SI-78-5-67A**
4.0 mm Ø **SI-78-5-67B**
Frontal sinus bougies



Cottle
120 mm – 4 3/4 "
SI-78-5-68
Handle



Cottle
7 mm
SI-78-5-69
Guide support for osteotomes

Pinces pour la cloison nasale
Septum forceps
Pinzas para el tabique nasal
Pinze per il setto nasale



Cottle-Walsham
230 mm – 9 "
SI-78-5-59
Straight



Cottle-Walsham
230 mm – 9 "
SI-78-5-60
Left



Cottle-Walsham
230 mm – 9 "
SI-78-5-61
Right

Pinces pour la cloison nasale
Septum forceps
Pinzas para el tabique nasal
Pinze per il setto nasale



Asch
230 mm – 9 "
SI-78-5-62



Middleton-Jansen
190 mm – 7 1/2 "
SI-78-5-63



Middleton-Jansen
190 mm – 7 1/2 "
SI-78-5-64



Caplan
200 mm – 8 "
SI-78-5-65
Toothed

Couteaux à végétations adénoïdes
Adenoid curettes
Cuchillos para vegetaciones adenoides
Adenotomi



St. Clair-Thomson
210 mm – 8 1/4 "



SI-AC-28-01



SI-AC-28-01A



SI-AC-28-01B



SI-AC-28-01C

Couteaux à végétations adénoïdes
Adenoid curettes
Cuchillos para vegetaciones adenoideas
Adenotomi



Barnhill
220 mm – 8 3/4 "



Fig. 1
SI-AC-28-02



Fig. 2
SI-AC-28-02A



Fig. 3
SI-AC-28-02B



Fig. 4
SI-AC-28-02C

Couteaux à végétations adénoïdes
Adenoid curettes
Cuchillos para vegetaciones adenoideas
Adenotomi



Beckmann
220 mm
Straight

SI-AC-28-03



SI-AC-28-03A



SI-AC-28-03B



Beckmann
220 mm
Curved

SI-AC-28-04



SI-AC-28-04A



SI-AC-28-04B



Beckmann
220 mm
Straight

SI-AC-28-05



SI-AC-28-05A



SI-AC-28-05B



Beckmann
220 mm
Curved

SI-AC-28-06



SI-AC-28-06A



SI-AC-28-06B



Couteaux à végétations adénoïdes
Adenoid curettes
Cuchillos para vegetaciones adenoides
Adenotomi

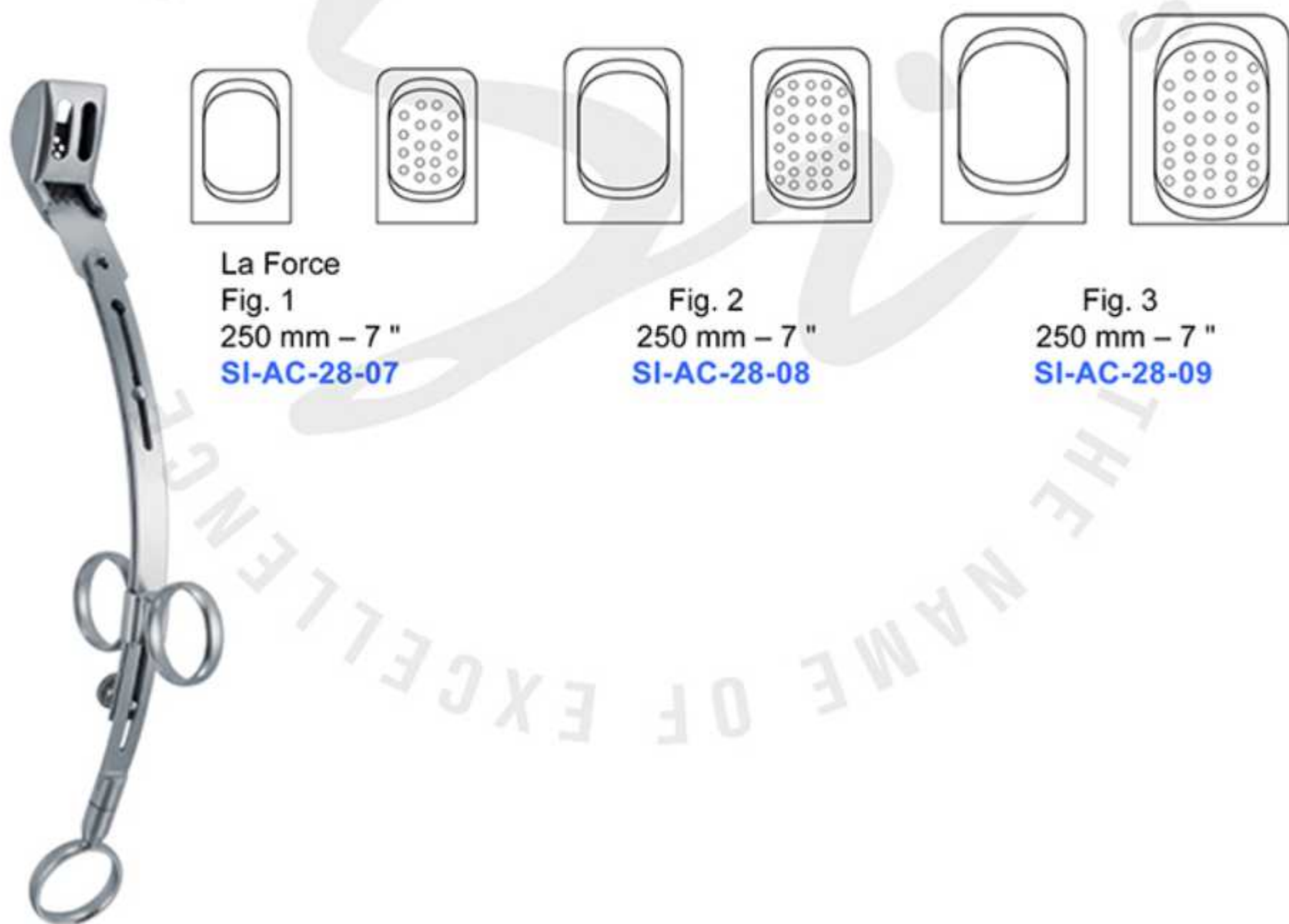

Couteaux à végétations adénoïdes
Adenoid curettes
Cuchillos para vegetaciones adenoideas
Adenotomi



Ballenger
200 mm – 8 "
x = 3 mm **SI-AC-28-10**
x = 4 mm **SI-AC-28-10A**
x = 5 mm **SI-AC-28-10B**
Straight

200 mm – 8 "
SI-AC-28-11
SI-AC-28-11A
SI-AC-28-11B
Bayonet

Ouvre-bouches
Mouth gags
Abrebocas
Apribocca



Whitehead
110 mm **SI-78-5-73**
130 mm **SI-78-5-73A**
150 mm **SI-78-5-73B**



Jennings
90 mm **SI-78-5-74**
110 mm **SI-78-5-74A**
130 mm **SI-78-5-74B**
150 mm **SI-78-5-74C**



Heister
130 mm – 5 "
SI-78-5-75

Ouvre-bouches
Mouth gags
Abrebocas
Apribocca



Molt
110 mm – 4 1/4 "
SI-78-5-76
For children



Molt
140 mm – 5 1/2 "
SI-78-5-77
For adults



Denhart
120 mm – 4 3/4 "
SI-78-5-78



Fergusson-Ackland
145 mm – 5 3/4 "
SI-78-5-79



Roser-Konig
160 mm **SI-78-5-80**
190 mm **SI-78-5-80A**

Ouvre-bouches
Mouth gags
Abrebocas
Apribocca



Dingmann
145 mm – 5 3/4 "
SI-78-5-83
Complete with frame,
3 tongue depressors and
2 adjustable lateral blades

55 x 25 mm
SI-78-5-83A

60 x 27 mm
SI-78-5-83B

70 x 30 mm
SI-78-5-83C



Fig. 3
37 mm x 80 mm
SI-78-5-84C

Fig. 2
32 mm x 75 mm
SI-78-5-84B

Fig. 1
28 mm x 65 mm
SI-78-5-84A

Kilner-Doughty
SI-78-5-84
Complete

Ouvre-bouches
Mouth gags
Abrebocas
Apribocca



Negus

Fig. 1
20 mm x 70 mm
SI-78-5-85

Fig. 2
30 mm x 80 mm
SI-78-5-85A

Fig. 3
33 mm x 95 mm
SI-78-5-85B

SI-78-5-85C
Handle

Complete

Ouvre-bouches
Mouth gags
Abrebocas
Apribocca



Davis-Boyle

Fig. 1	Fig. 2	Fig. 3	Fig. 4	Fig. 5	
SI-78-5-86F	SI-78-5-86G	SI-78-5-86H	SI-78-5-86I	SI-78-5-86J	SI-78-5-86K
17 x 26 mm	19 x 46 mm	20 x 58 mm	22 x 71 mm	22 x 80 mm	Handle, rigid
Complete, for Children					

Ouvre-bouches
Mouth gags
Abrebocas
Apribocca



Davis-Boyle



Fig. 1

SI-78-5-87

21 x 30 mm

Complete, for adults



Fig. 2

SI-78-5-87A

23 x 65 mm



Fig. 3

SI-78-5-87B

24 x 80 mm



Fig. 4

SI-78-5-87C

25 x 93 mm



Fig. 5

SI-78-5-87D

26 x 108 mm



SI-78-5-87E

Handle, movable

Davis-Boyle

Fig. 1

SI-78-5-87F

17 x 26 mm

Complete, for Children

Fig. 2

SI-78-5-87G

19 x 46 mm

Fig. 3

SI-78-5-87H

20 x 58 mm

Fig. 4

SI-78-5-87I

22 x 71 mm

Fig. 5

SI-78-5-87J

22 x 80 mm

SI-78-5-87K

Handle, movable

Ouvre-bouches
Mouth gags
Abrebocas
Apribocca



Mclvor

Fig. 1
SI-78-5-88
23 x 70 mm

Fig. 2
SI-78-5-88A
25 x 86 mm

Fig. 3
SI-78-5-88B
26 x 100 mm

SI-78-5-88C

Complete

Handle, movable

Instruments laryngiens
Laryngeal instruments
Instrumentos laringeos
Strumenti laringei



Reichert
230 mm – 9 "
SI-LI-29-01

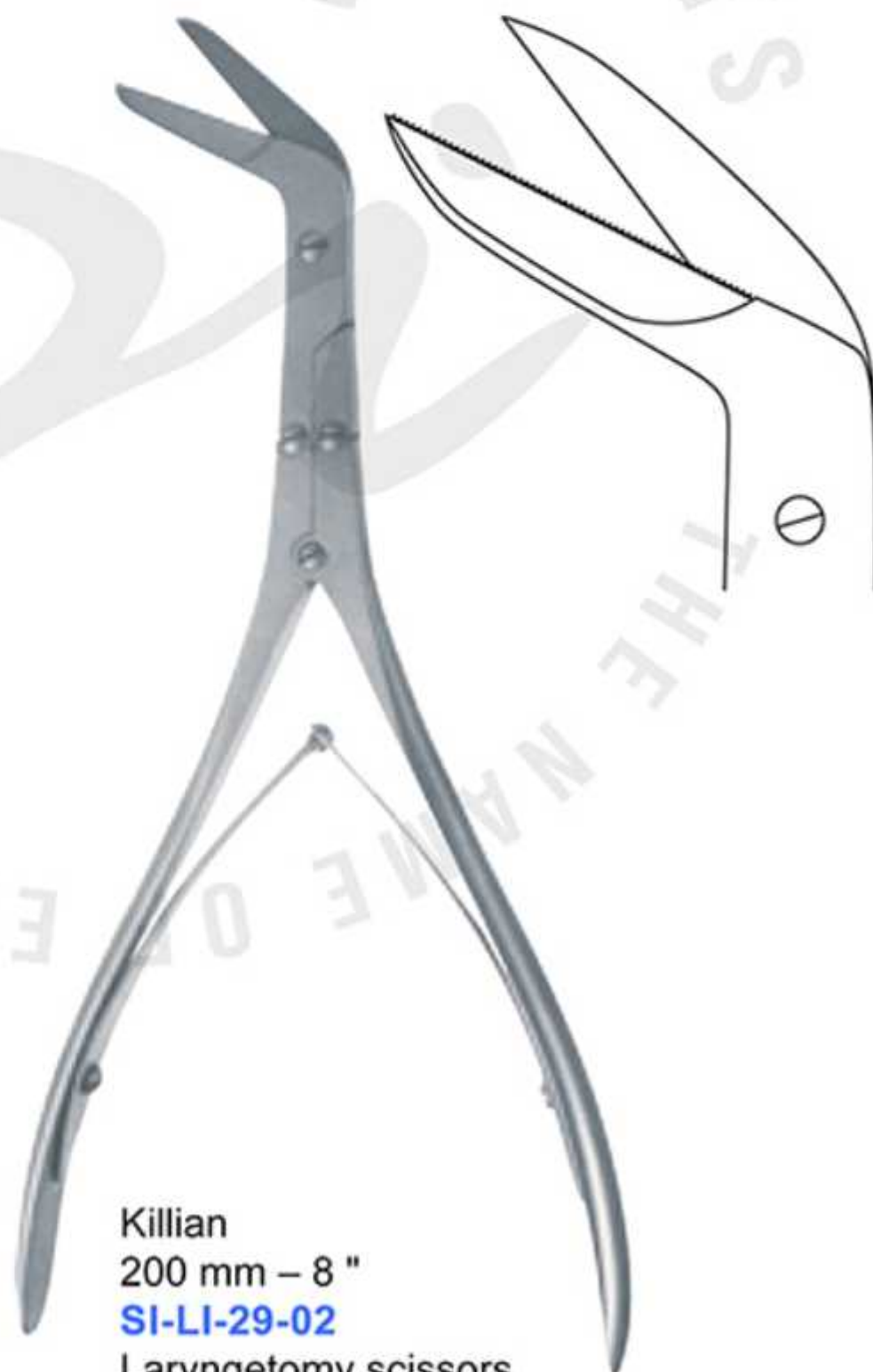

Killian
200 mm – 8 "
SI-LI-29-02
Laryngotomy scissors

Serre noeuds pour amygdales
Tonsil snares
Cierra-nudos para amigdales
Serranodi per tonsille



Serre noeuds pour amygdales
Tonsil snares
Cierra-nudos para amigdales
Serranodi per tonsille



Bruenings
280 mm – 11 "
SI-TS-30-04
for soldered loops

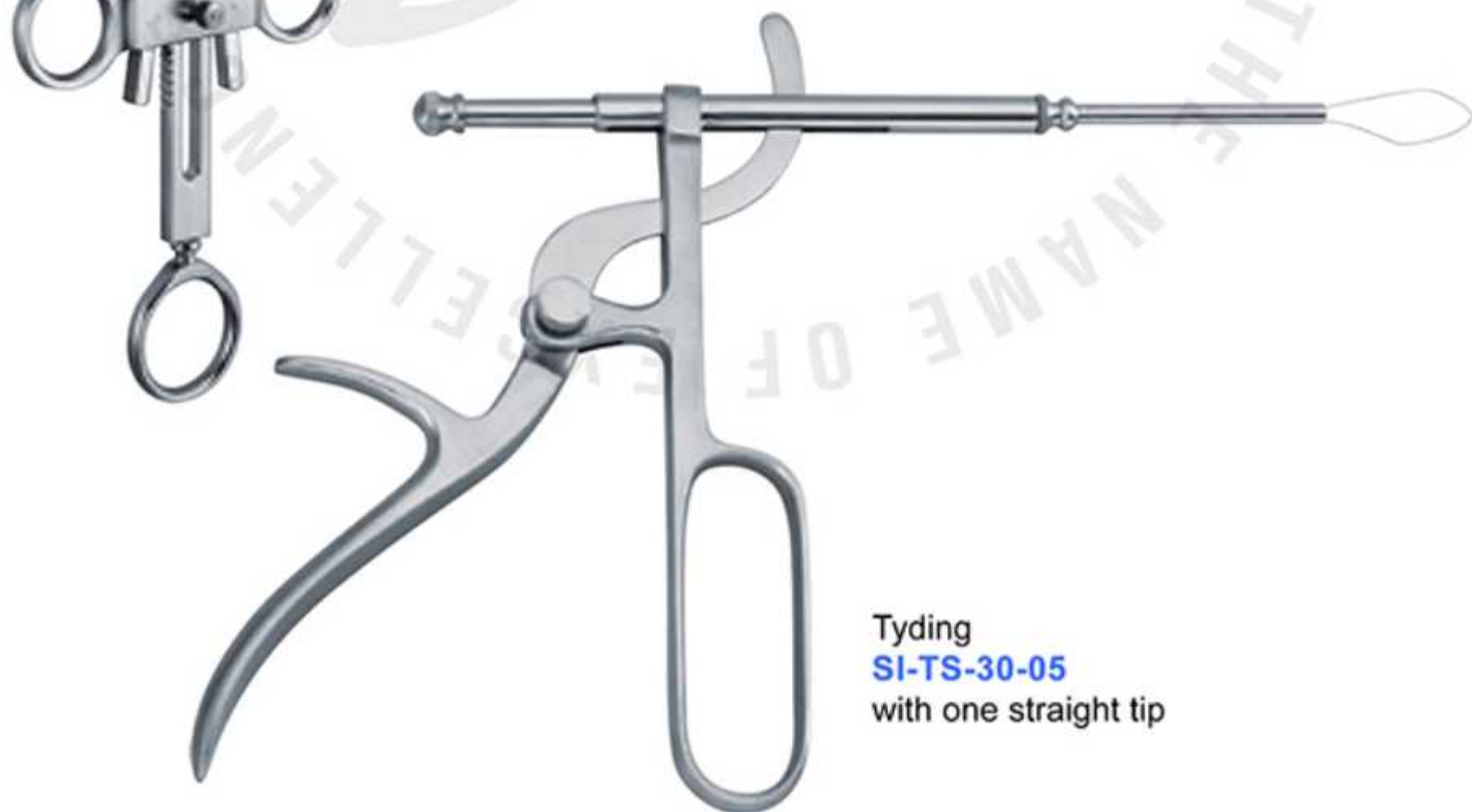

Tyding
SI-TS-30-05
with one straight tip

Instruments pour amygdales
Tonsil instruments
Instrumentos para amigdalas
Strumenti per tonsille



Carpenter
250 mm – 9 3/4 "
SI-TI-31-01
Enucleator



Luniatschek
180 mm – 7 "
SI-TI-31-02
Tonsil tampon plugger



Henke
230 mm – 9 "
SI-TI-31-03
Tonsil dissector

Instruments pour amygdales
Tonsil instruments
Instrumentos para amígdalas
Strumenti per tonsille



Henke
230 mm – 9 "
SI-TI-31-04
Tonsil dissector

Hurd
225 mm – 8 3/4 "
SI-TI-31-05
Tonsil dissector

Lewis
195 mm – 7 3/4 "
SI-TI-31-06
Tonsil screw

Instruments pour amygdales
Tonsil instruments
Instrumentos para amigdalas
Strumenti per tonsille



Marschik
220 mm – 8 3/4 "
SI-TI-31-07
Tonsil seizing forceps



Colver
190 mm
SI-TI-31-09
Straight

190 mm
SI-TI-31-09A
Curved



Blohmke
200 mm – 8 "
SI-TI-31-08

Instruments pour amygdales
Tonsil instruments
Instrumentos para amígdalas
Strumenti per tonsille



White
180 mm **SI-TI-31-10**
230 mm **SI-TI-31-10A**
6x5



Jackson
220 mm – 8 3/4 "
SI-TI-31-12
Laryngeal forceps



Museux
200 mm – 8 "
SI-TI-31-11
Tonsil holding forceps

Amygdalatomes
Tonsillectomes
Amigdalótomos
Tonsillotomi

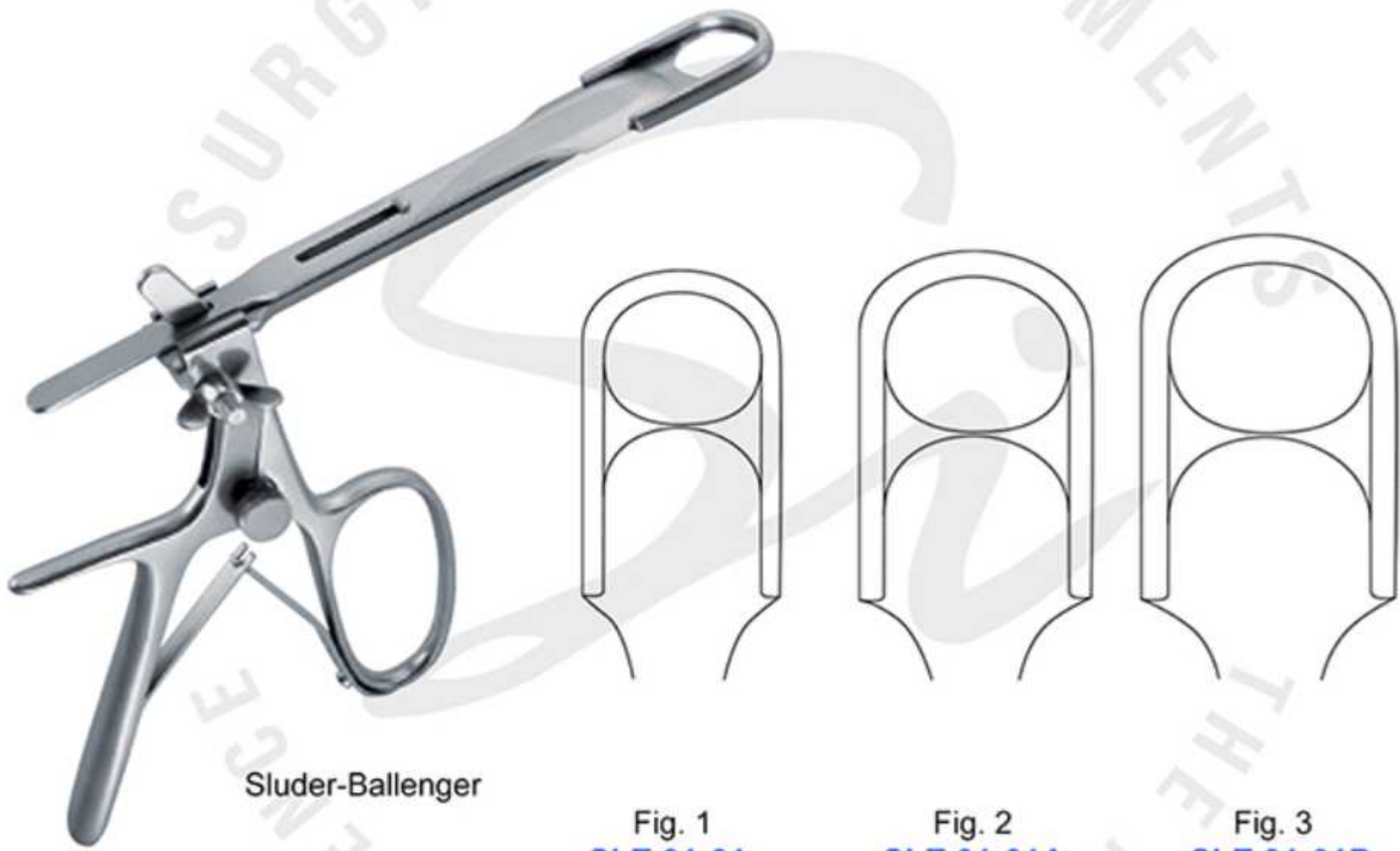

Dilatateurs pour la trachéotomie
Trachea dilators
Dilatadores para la tráqueotomía
Dilatatori tracheali



Laborde
120mm **SI-TD-32-01**
140mm **SI-TD-32-01A**
for children



Trousseau
120mm **SI-TD-32-02**
140mm **SI-TD-32-02A**
for children

***Si* SURGICA**
INSTRUMENTS
THE NAME OF EXCELLENCE



MICRO- & NEURO SURGERY

- CERVICAL TRACTION TONGS
- HAND DRILLS
- INSTRUMENTS FOR CRANIAL OPENING
- NERVE HOOKS PROB
- DURA KNIVES
- MICRO DISSECTORS PROB
- NEURO-MICRO DISSECTORS
- & MORE

Pinces de traction crânienne
Cervical traction tongs
Pinzas de traccion cranial
Pinze per trazione craniale



Crutchfield



3.5 mm Ø

SI-NS-2-01



5.0 mm Ø

SI-NS-2-02

Complete Set



Crutchfield



3.5 mm Ø

SI-NS-2-03



5.0 mm Ø

SI-NS-2-04

Complete Set

Pinces de traction crânienne
Cervical traction tongs
Pinzas de traccion cranial
Pinze per trazione craniale



Large type, cervical traction tongs
SI-NS-2-05

Perforateurs à main
Hand drills
Perforadores a mano
Perforatori a mano



Hudson
270 mm – 10 3/4"
SI-NS-2-06
Complete Set with 4 twist drills
(Fig. 1 – Fig. 4) and extension piece



Extension piece



Fig. 1
9 mm Ø



Fig. 2
14 mm Ø



Fig. 3
16 mm Ø



Fig. 4
22 mm Ø



Cushing
14 mm Ø



McKenzie
13 mm Ø

Instruments pour l'ouverture du crâne
Instruments for cranial opening
Instrumentos para apertura craneana
Strumenti per l'apertura del cranio



De Martel
330 mm – 13"
SI-NS-2-09



De Vilbiss
210 mm – 8 1/4"
SI-NS-2-08



Adson
150 mm – 6"
SI-NS-2-07

Instruments pour l'ouverture du crâne
Instruments for cranial opening
Instrumentos para apertura craneana
Strumenti per l'apertura del cranio



Olivecrona		
300 mm – 12"	– 1.2 mm Ø	SI-NS-2-10
400 mm – 16"	– 1.2 mm Ø	SI-NS-2-10A
500 mm – 20"	– 1.2 mm Ø	SI-NS-2-10B
600 mm – 23 1/2"	– 1.2 mm Ø	SI-NS-2-10C
700 mm – 27 1/2"	– 1.2 mm Ø	SI-NS-2-10D

Gigli		
300 mm – 12"	– 1.4 mm Ø	SI-NS-2-11
400 mm – 16" – 12"	– 1.4 mm Ø	SI-NS-2-11A
500 mm – 20" – 12"	– 1.4 mm Ø	SI-NS-2-11B



Gigli Handle
SI-NS-2-12

Crochets à nerfs
Nerve hooks
Ganchos para nervios
Uncini per nervi



Scoville
230 mm – 9"
x = 8 mm
SI-NS-2-13

Holsher
240 mm – 9 1/2"
x = 7 mm
SI-NS-2-14

Scoville
200 mm – 8"
x = 7 mm
SI-NS-2-15

Crochets à nerfs
Nerve hooks
Ganchos para nervios
Uncini per nervi

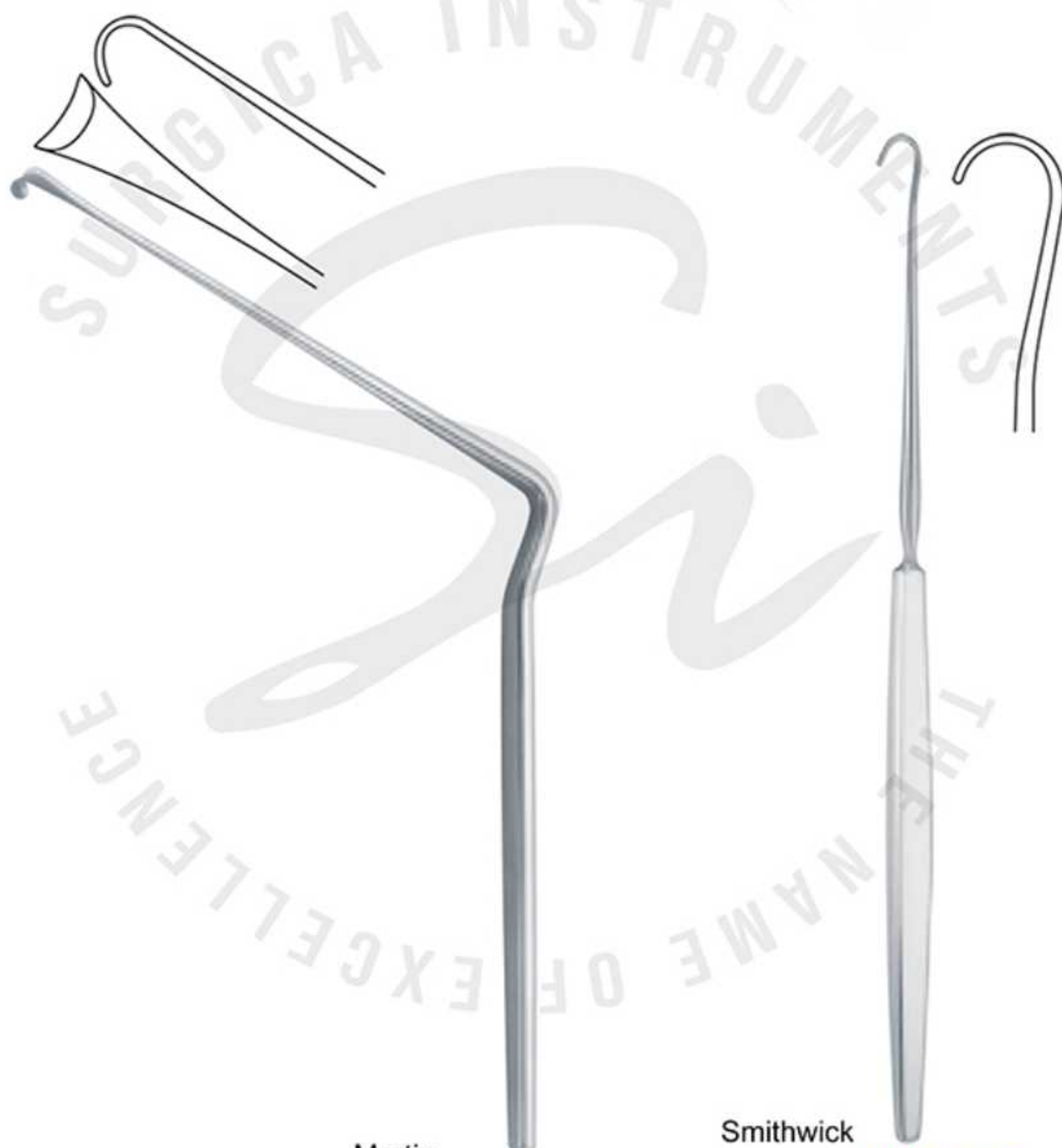

Martin
210 mm – 8 1/4 "
x = 7 mm
SI-NS-2-16

Smithwick
170 mm **SI-NS-2-17**
210 mm **SI-NS-2-17A**

Crochets à nerfs
Nerve hooks
Ganchos para nervios
Uncini per nervi

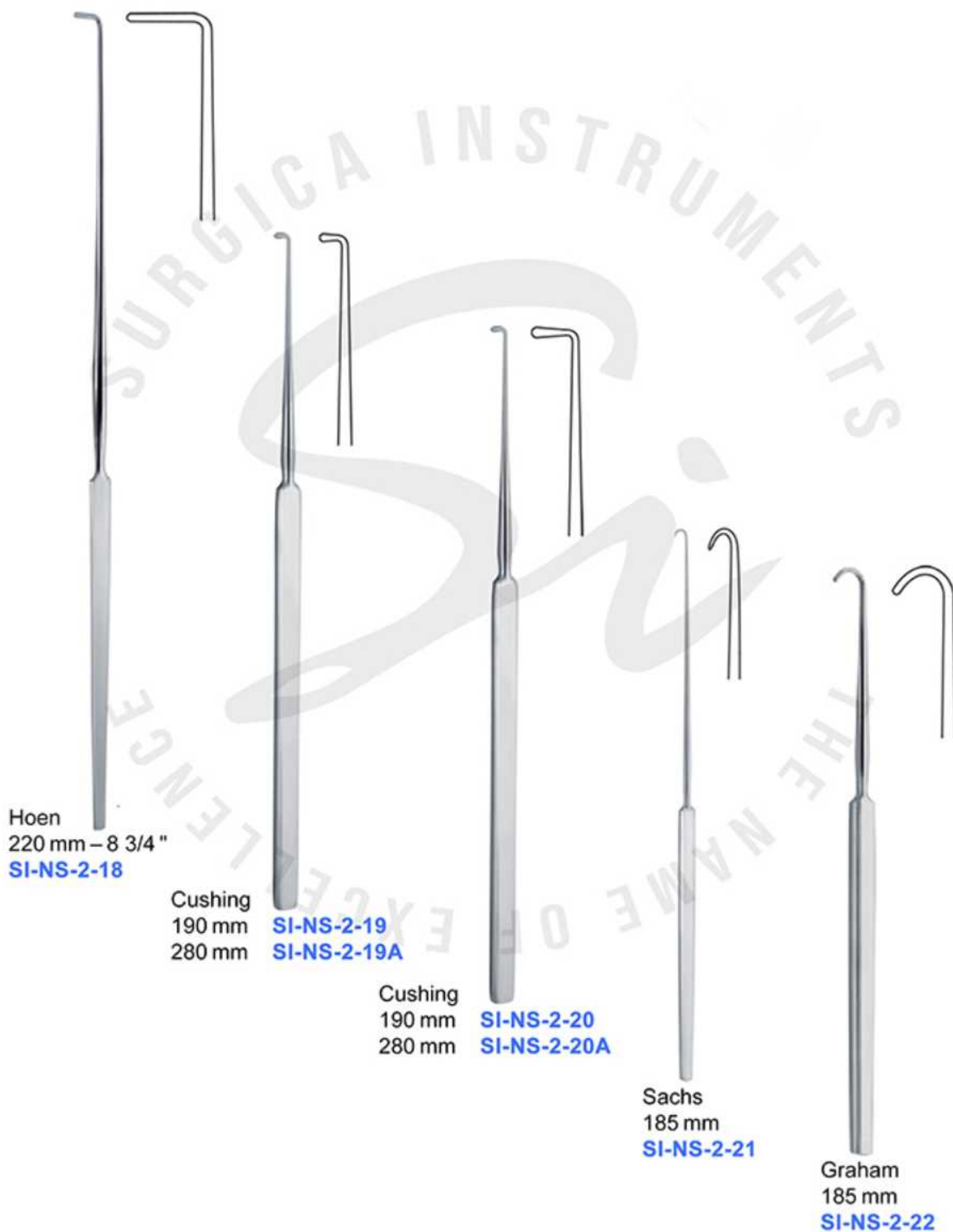

Crochets à nerfs
Nerve hooks
Ganchos para nervios
Uncini per nervi



Crochets à nerfs
Nerve hooks
Ganchos para nervios
Uncini per nervi



Crochets à nerfs
Nerve hooks
Ganchos para nervios
Uncini per nervi



Crochets à nerfs
Nerve hooks
Ganchos para nervios
Uncini per nervi



Cushing
140 mm – 5 1/2"
SI-NS-2-36



Frazier
130 mm **SI-NS-2-37**
180 mm **SI-NS-2-37A**
Sharp



Frazier
130 mm **SI-NS-2-38**
180 mm **SI-NS-2-38A**
Blunt



Lahey
130 mm – 5"
SI-NS-2-39

Bistouries pour duremère
Dura knives
Bisturís para duramadre
Bisturi per duramadre



Toennis
150 mm – 6 "
SI-NS-2-40



Toennis
190 mm – 7 1/2 "
SI-NS-2-41



Halle
200 mm – 8 "
SI-NS-2-42

Micro dissecteurs
Micro dissectors
Micro disectores
Micro dissetori

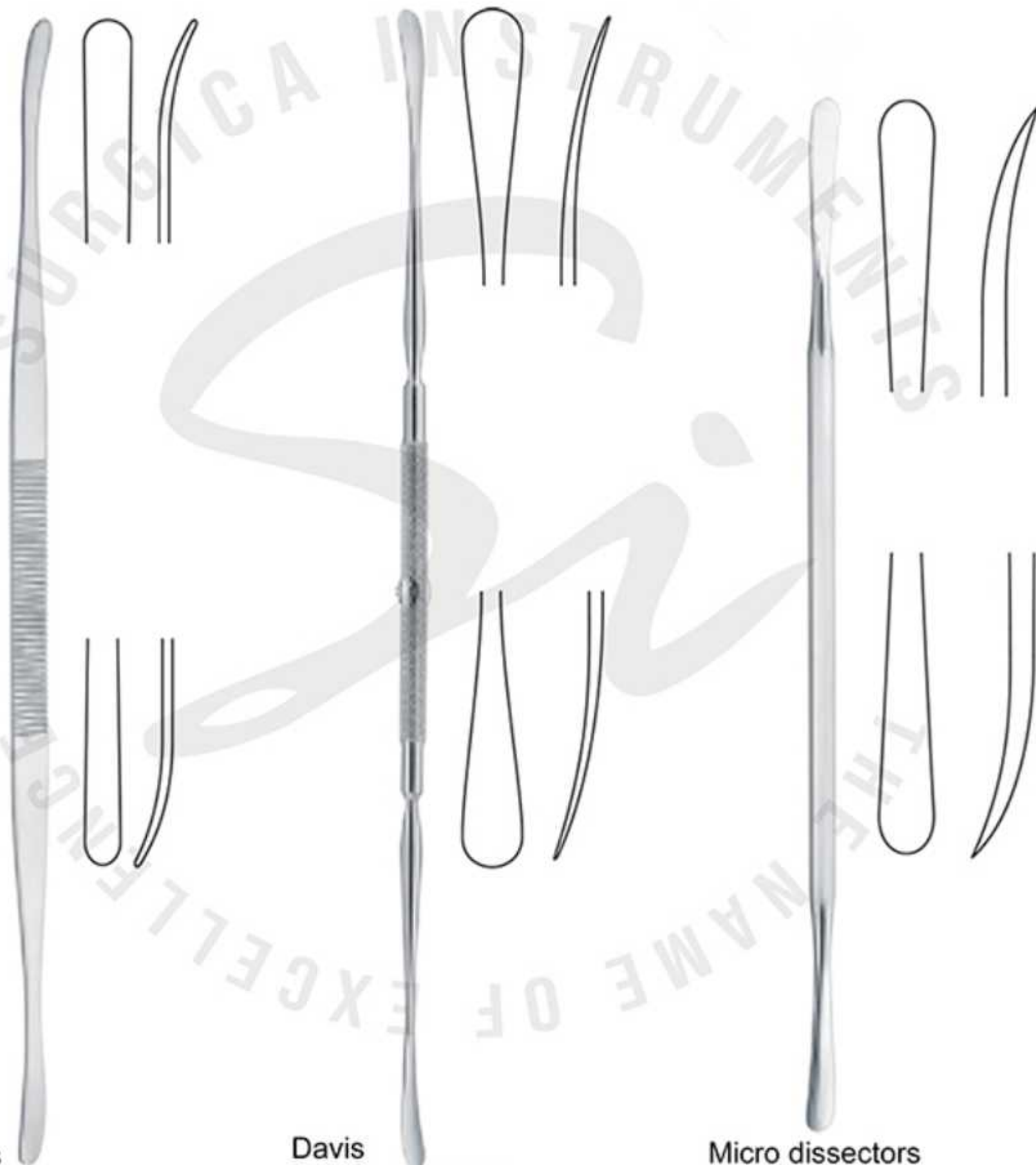

Toennis
250 mm – 9 3/4 "
SI-NS-2-43

Davis
245 mm – 9 3/4 "
SI-NS-2-44

Micro dissectors
220 mm – 8 3/4 "
SI-NS-2-45

Micro dissecteurs
Micro dissectors
Micro disectores
Micro dissetori

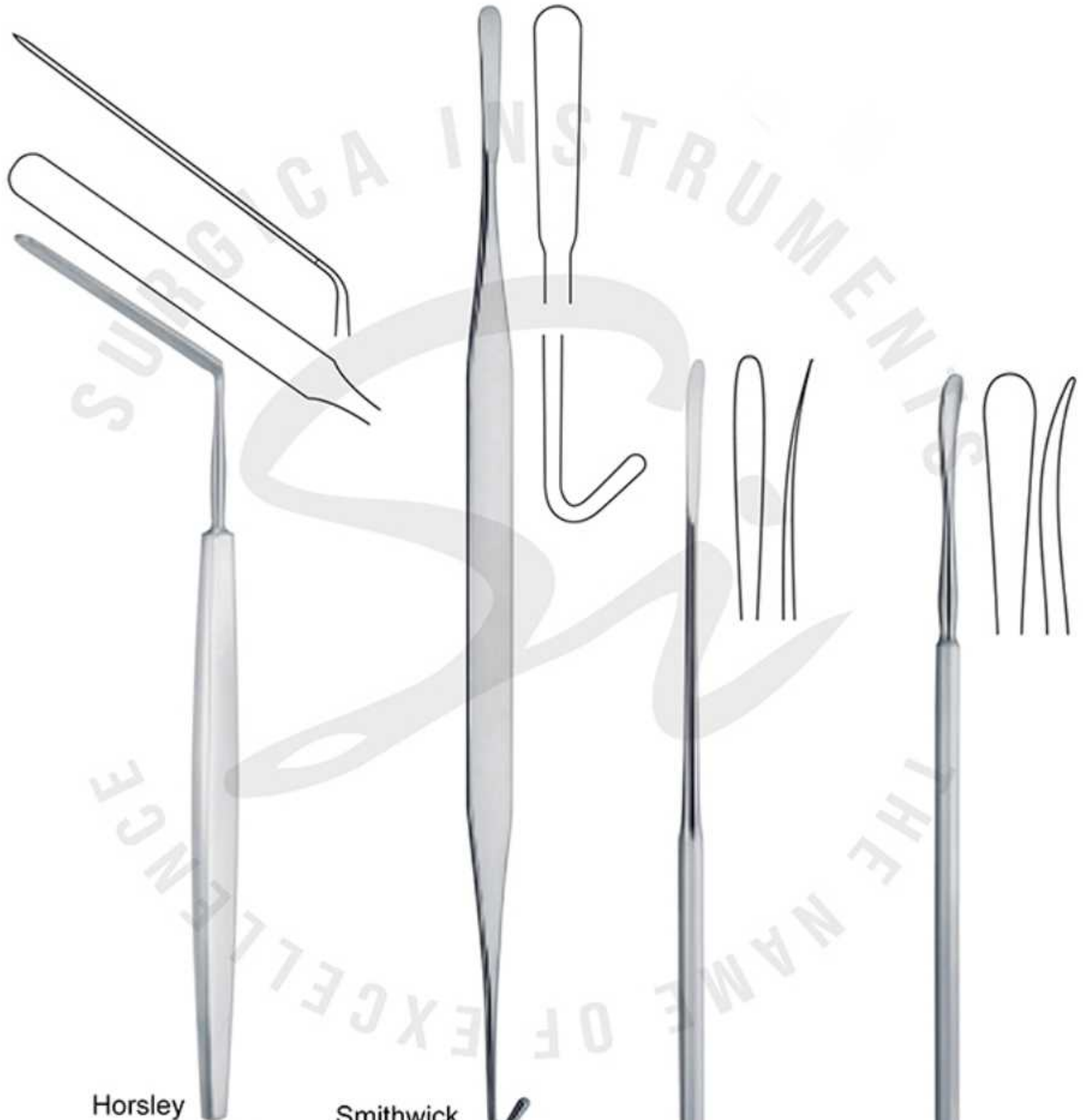

Horsley
200 mm – 8"
SI-NS-2-46

Smithwick
290 mm – 11 1/2"
SI-NS-2-47

Sachs
210 mm – 8 1/4"
SI-NS-2-48

Sachs
210 mm – 8 1/4"
SI-NS-2-49

Micro dissecteurs
Micro dissectors
Micro disectores
Micro dissetori



Sachs
210 mm – 8 1/4"
SI-NS-2-50



Penfield
Fig. 1
175 mm – 7"
SI-NS-2-51



Penfield
Fig. 2
195 mm – 7 3/4"
SI-NS-2-52

Micro dissecteurs
Micro dissectors
Micro disectores
Micro dissetori



Penfield
Fig. 3
195 mm – 7 3/4 "
SI-NS-2-53



Penfield
Fig. 4
215 mm – 8 1/2 "
SI-NS-2-54



Penfield
Fig. 5
185 mm – 7 1/4 "
SI-NS-2-55

Neuro-micro dissecteurs
Neuro-micro dissectors
Disectores para micro-neurocirugía
Strumento per micro-neuro chirurgia

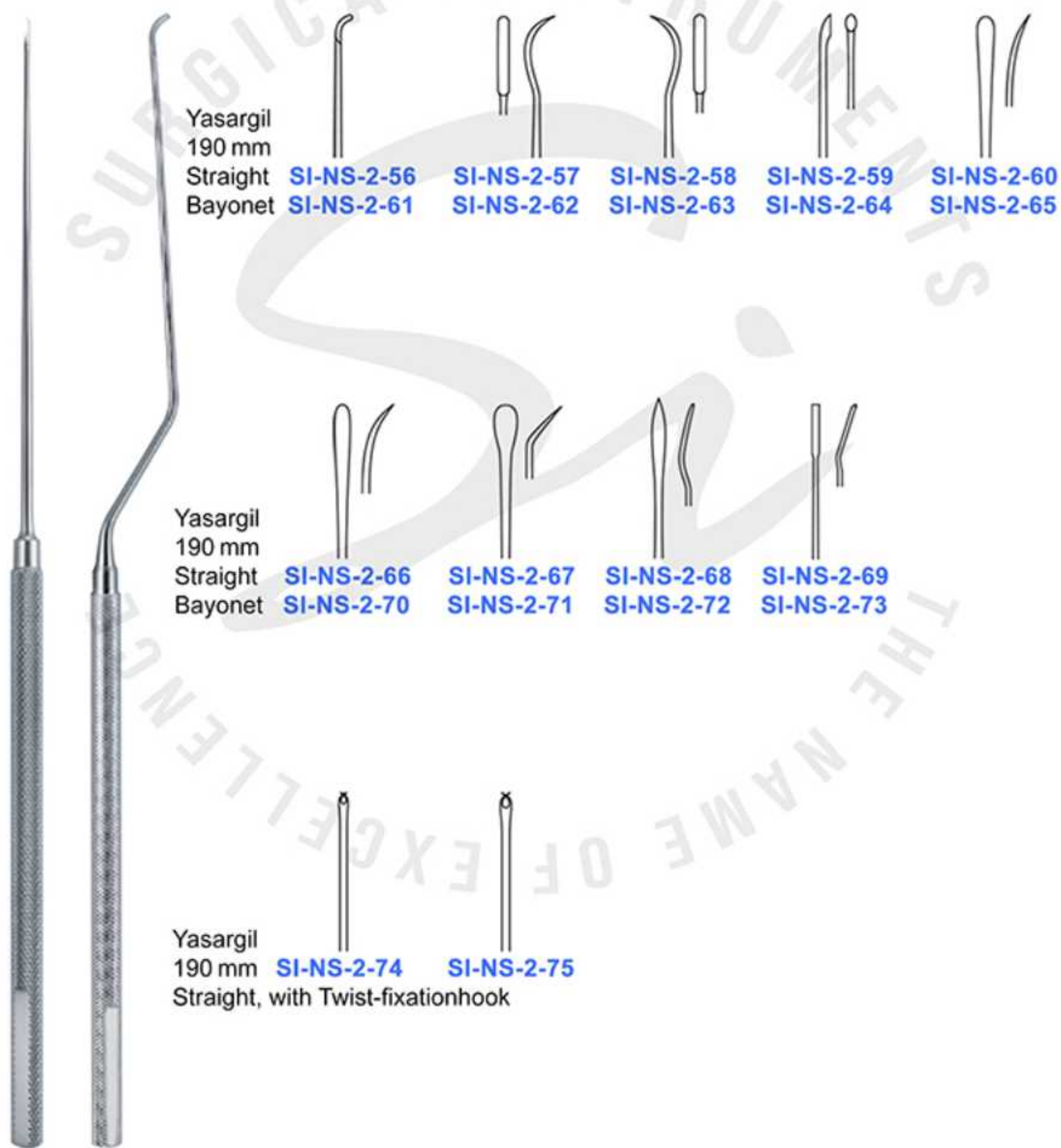

MICRO- & NEURO SURGERY

Neuro-micro dissecteurs
Neuro-micro dissectors
Disectores para micro-neurocirugía
Strumento per micro-neuro chirurgia

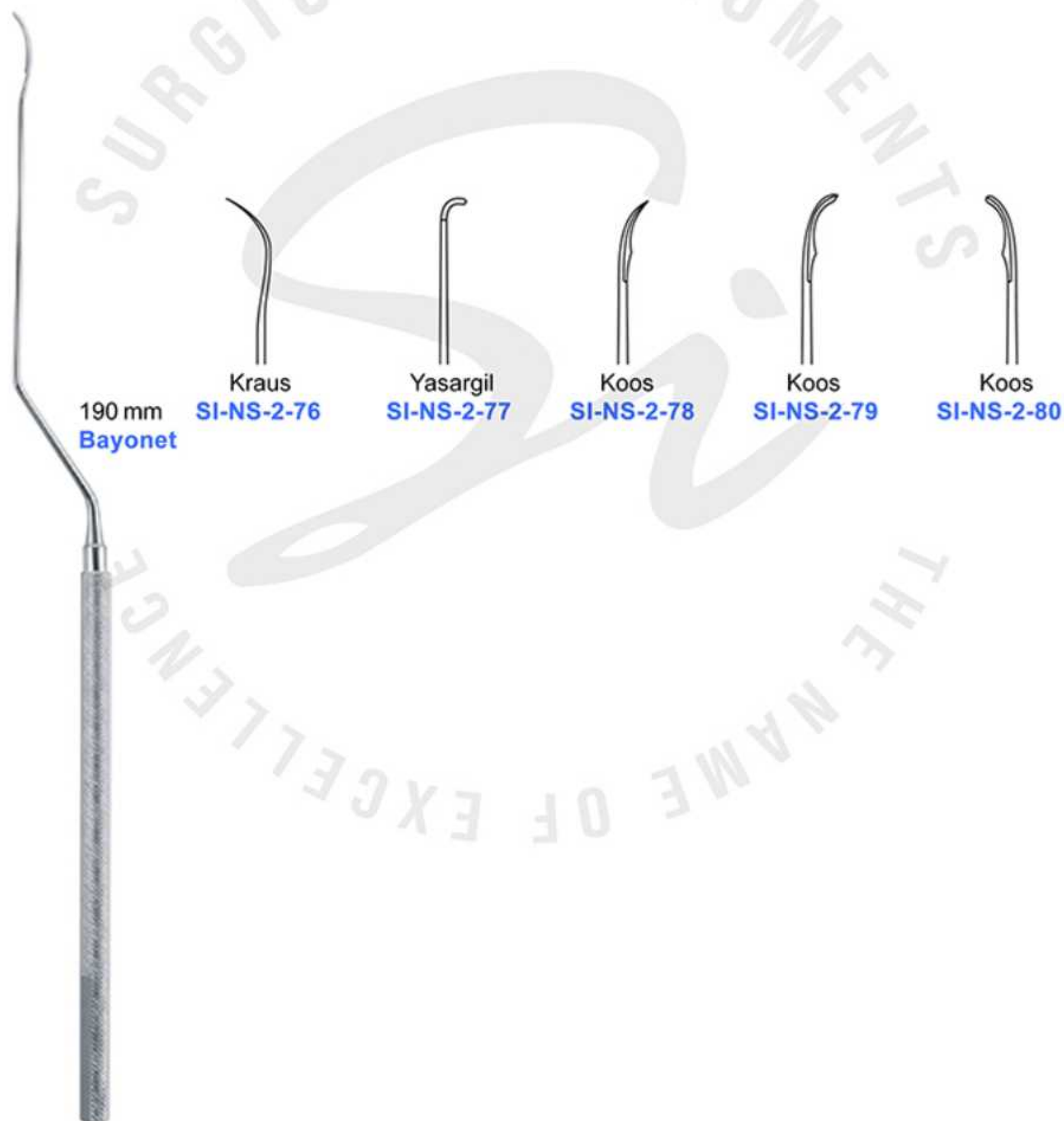

Neuro-micro dissecteurs
Neuro-micro dissectors
Disectores para micro-neurocirugía
Strumento per micro-neuro chirurgia

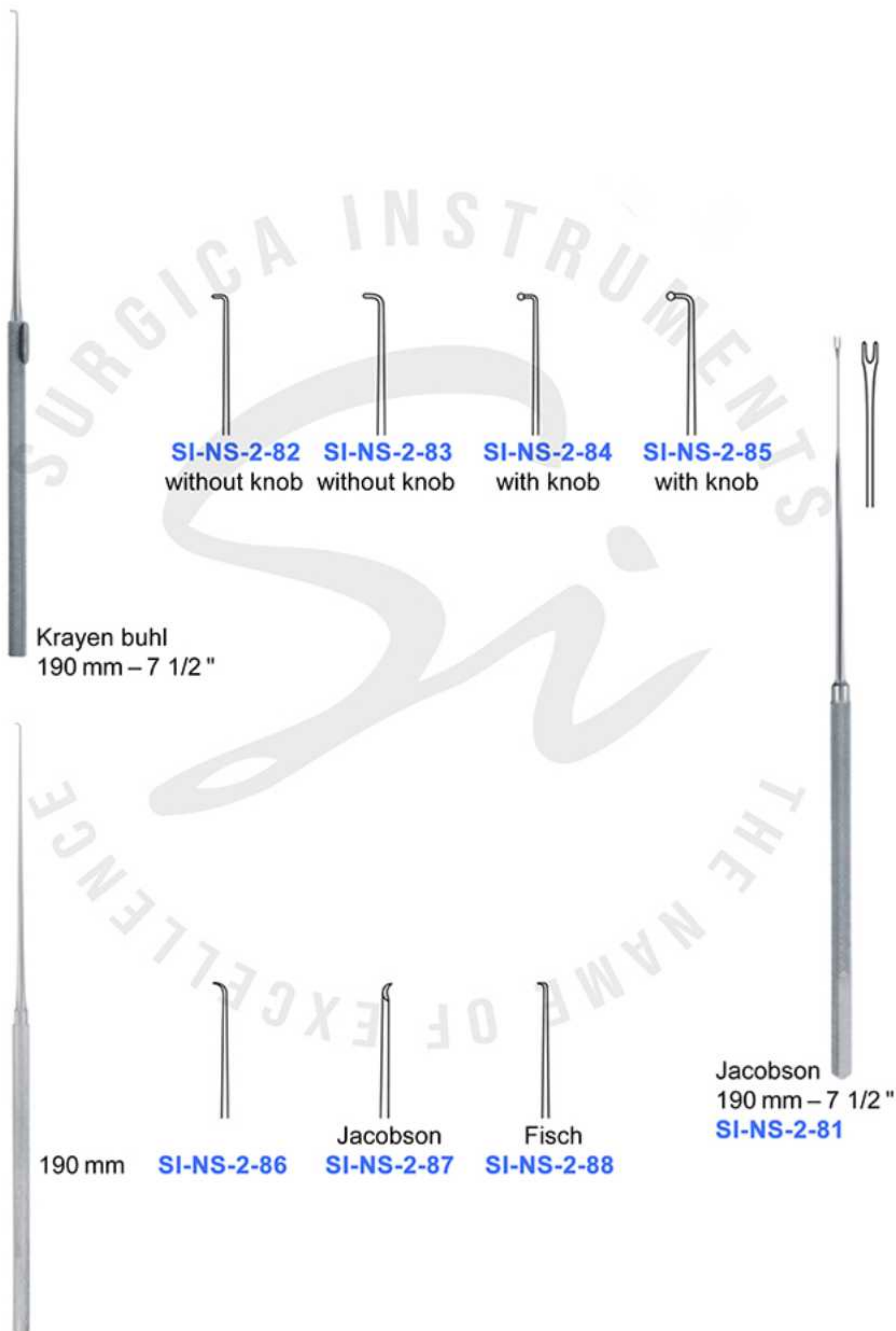

Neuro-micro dissecteurs
Neuro-micro dissectors
Disectores para micro-neurocirugía
Strumento per micro-neuro chirurgia

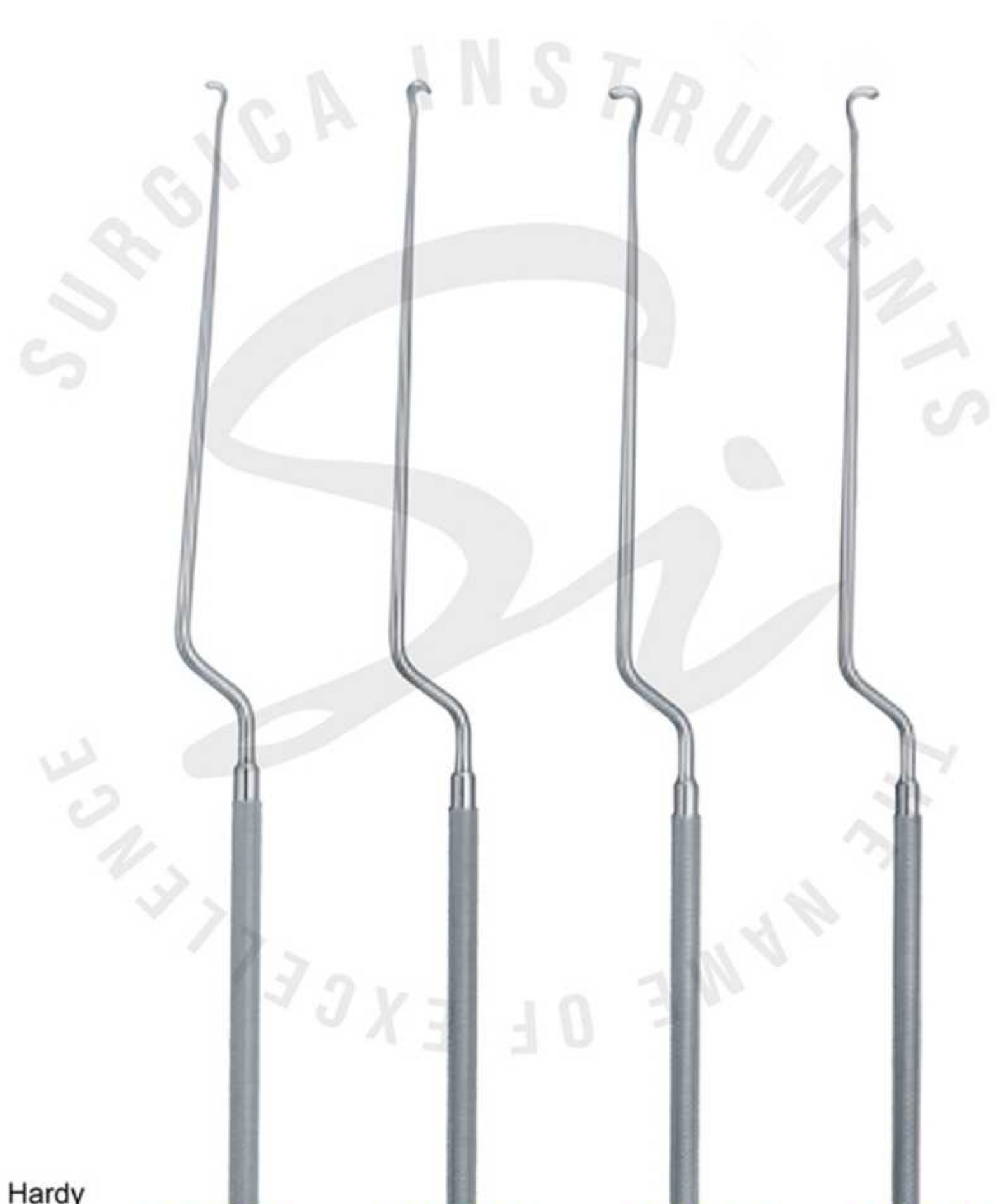

Hardy
250 mm
Bayonet, sharp inner edge

SI-NS-2-89

SI-NS-2-90

SI-NS-2-91

SI-NS-2-92

Neuro-micro dissecteurs
Neuro-micro dissectors
Disectores para micro-neurocirugía
Strumento per micro-neuro chirurgia



Hardy

4 mm Ø

270 mm **SI-NS-2-93**

Bayonet, malleable

6 mm Ø

SI-NS-2-94

Micro ciseaux à ressorts
Micro scissors
Micro tijeras con resorte
Forbici per microchirurgia



Vannas
80 mm
Vannas-blade



SI-MS-01-01



SI-MS-01-02

SURGICA INSTRUMENTS
THE NAME OF EXCELLENCE

Micro ciseaux à ressorts
Micro scissors
Micro tijeras con resorte
Forbici per microchirurgia



Micro Scissor

120 mm – 4 3/4 "
Blade 10mm, sharp

SI-MS-01-03
Straight



SI-MS-01-04
Curved



120 mm – 4 3/4 "
Vannas-blade

SI-MS-01-05
Straight



SI-MS-01-06
Curved



SI-MS-01-07
Angled up



120 mm – 4 3/4 "
Vein-blade (Biemer)

SI-MS-01-08
Straight



Micro ciseaux à ressorts

Micro scissors

Micro tijeras con resorte

Forbici per microchirurgia



Micro Scissor

150 mm

SI-MS-01-09

Straight
Short blades



SI-MS-01-10

Curved
Short blades



SI-MS-01-11

Straight
Long blades



SI-MS-01-12

Curved
Long blades



150 mm

SI-MS-01-13

Straight
Saw edge



SI-MS-01-14

Curved
Saw edge



150 mm

SI-MS-01-15

180 mm

SI-MS-01-15A

Angled on flat, 45°



Micro ciseaux à ressorts
Micro scissors
Micro tijeras con resorte
Forbici per microchirurgia



120 mm – 4 3/4 "
Long blades 14mm
Smooth, sharp

SI-MS-01-16
Straight



SI-MS-01-17
Curved



120 mm – 4 3/4 "
Long blades 14mm
Sharp

SI-MS-01-18
Straight
Saw edge



SI-MS-01-19
Curved
Saw edge



145 mm – 5 3/4 "
Vannas-blades
Smooth, sharp

SI-MS-01-20
Straight



SI-MS-01-21
Curved



Micro ciseaux à ressorts
Micro scissors
Micro tijeras con resorte
Forbici per microchirurgia



Yasargil
185 mm



SI-MS-01-22
Straight



SI-MS-01-23
Curved



SI-MS-01-24
Angled on flat

Micro ciseaux à ressorts
Micro scissors
Micro tijeras con resorte
Forbici per microchirurgia



Yasargil
170 mm
With ball



25°

SI-MS-01-25



45°

SI-MS-01-26

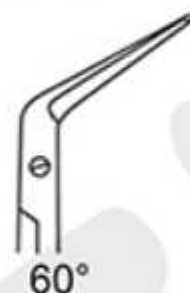

60°

SI-MS-01-27

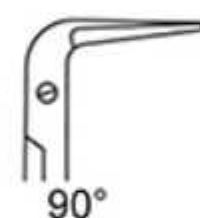

90°

SI-MS-01-28



125°

SI-MS-01-29



25°

SI-MS-01-30



45°

SI-MS-01-31



60°

SI-MS-01-32

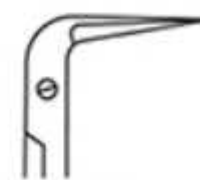

90°

SI-MS-01-33



125°

SI-MS-01-34

Yasargil
170 mm
Without ball

Micro ciseaux à ressorts
Micro scissors
Micro tijeras con resorte
Forbici per microchirurgia



Micro Scissor

145 mm
180 mm
Short blades
8mm, Smooth

SI-MS-01-35
SI-MS-01-35A
Straight
Sharp

SI-MS-01-36
SI-MS-01-36A
Curved
Sharp

SI-MS-01-37
SI-MS-01-37A
Straight
Blunt

SI-MS-01-38
SI-MS-01-38A
Curved
Blunt

145 mm
180 mm
Long blades
14mm, Smooth

SI-MS-01-39
SI-MS-01-39A
Straight
Sharp

SI-MS-01-40
SI-MS-01-40A
Curved
Sharp

SI-MS-01-41
SI-MS-01-41A
Straight
Blunt

SI-MS-01-42
SI-MS-01-42A
Curved
Blunt

Micro ciseaux à ressorts
Micro scissors
Micro tijeras con resorte
Forbici per microchirurgia



Vannas
120 mm

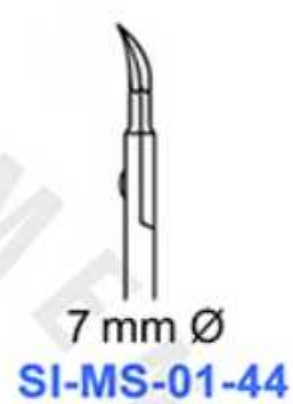

Vannas
150 mm



Castroviejo
150 mm

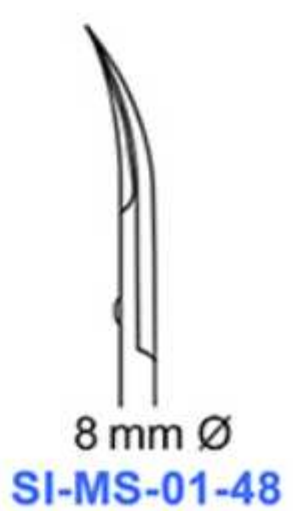
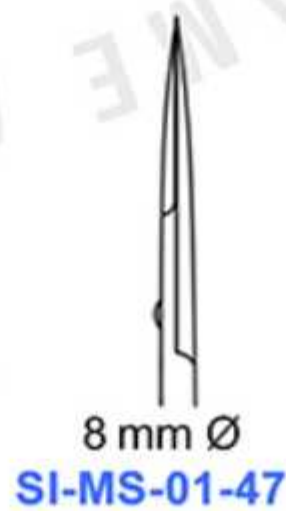

Micro ciseaux à ressorts
Micro scissors
Micro tijeras con resorte
Forbici per microchirurgia



Micro Scissor

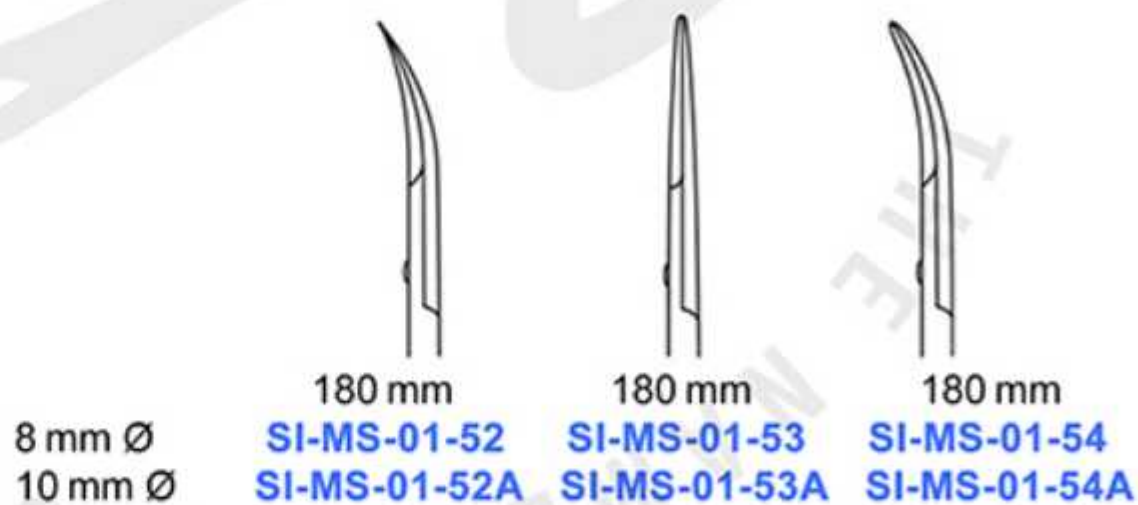

Micro ciseaux à ressorts
Micro scissors
Micro tijeras con resorte
Forbici per microchirurgia



Micro Scissor

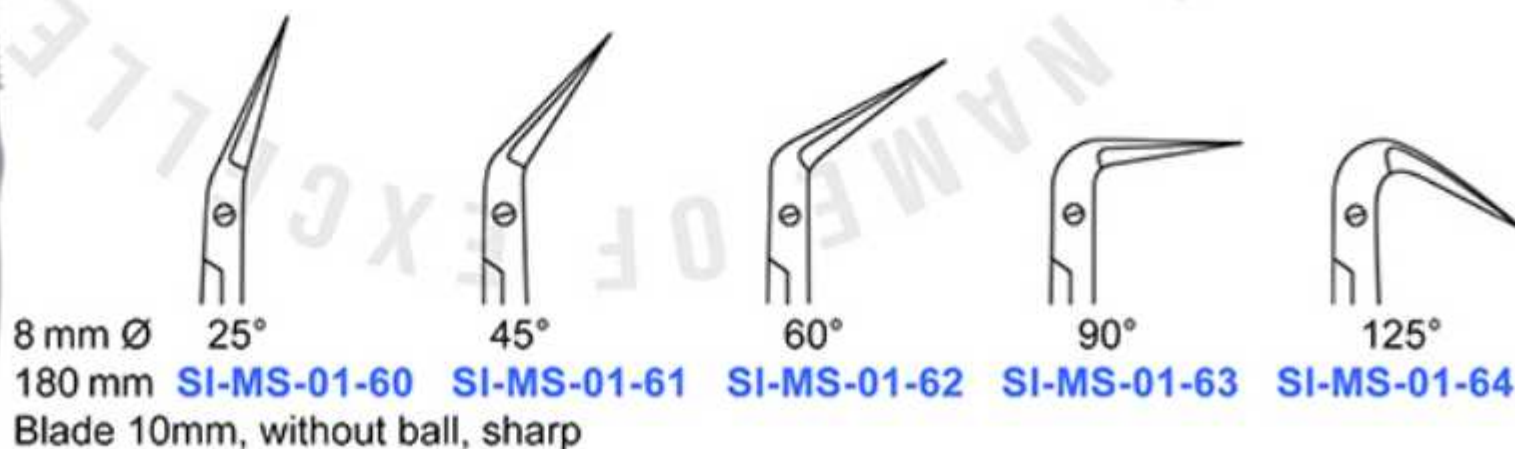
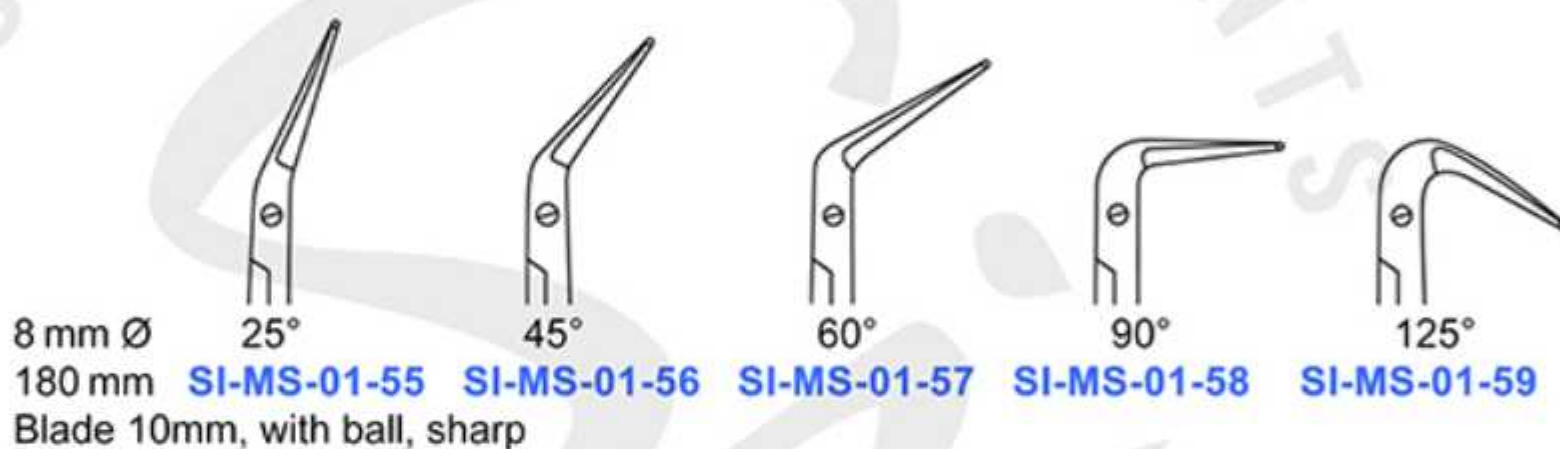

Micro ciseaux à ressorts

Micro scissors

Micro tijeras con resorte

Forbici per microchirurgia



Micro Scissor

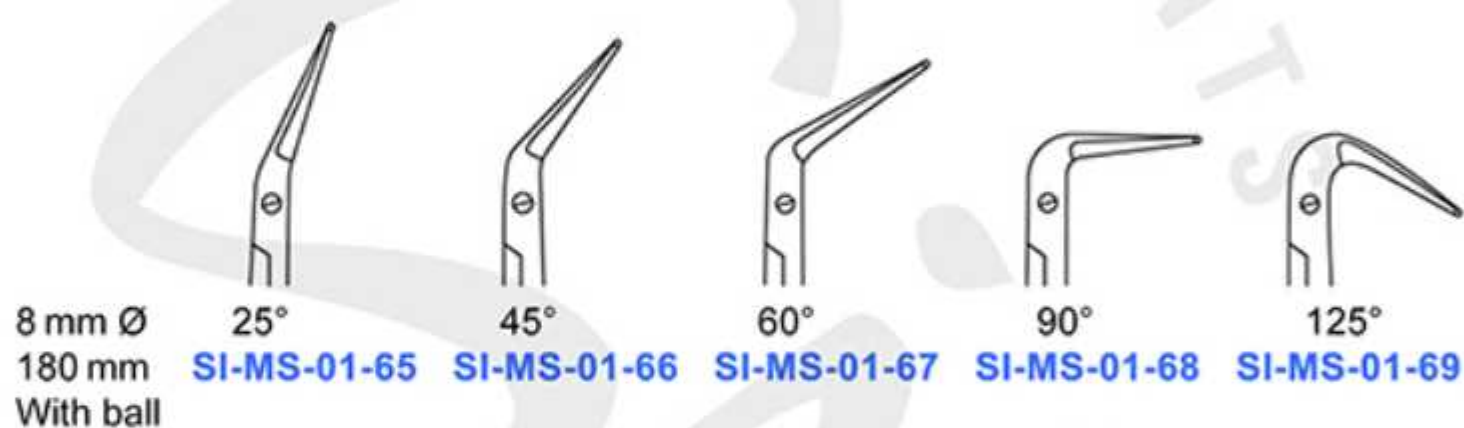

8 mm Ø
180 mm
With ball

25° SI-MS-01-65 45° SI-MS-01-66 60° SI-MS-01-67 90° SI-MS-01-68 125° SI-MS-01-69



8 mm Ø
180 mm
Without ball

25° SI-MS-01-70 45° SI-MS-01-71 60° SI-MS-01-72 90° SI-MS-01-73 125° SI-MS-01-74

Micro ciseaux à ressorts
Micro scissors
Micro tijeras con resorte
Forbici per microchirurgia



Jacobson
160 mm
180 mm

SI-MS-01-75
SI-MS-01-75A
Straight



SI-MS-01-76
SI-MS-01-76A
Curved



SI-MS-01-77
SI-MS-01-77A
Angled, 45°



Jacobson
160 mm
180 mm
Vannas blade

SI-MS-01-78
SI-MS-01-78A



SI-MS-01-79
SI-MS-01-79A



Micro ciseaux à ressorts
Micro scissors
Micro tijeras con resorte
Forbici per microchirurgia



Yasargil-mod.
180 mm
225 mm



220 mm
Vannas blade

Micro ciseaux à ressorts
Micro scissors
Micro tijeras con resorte
Forbici per microchirurgia



200 mm
225 mm
Blade smooth
Sharp



SI-MS-01-84
SI-MS-01-84A
Straight



SI-MS-01-85
SI-MS-01-85A
Curved



SI-MS-01-86
SI-MS-01-86A
Straight
Saw edge



SI-MS-01-87
SI-MS-01-87A
Curved
Saw edge



SI-MS-01-88
SI-MS-01-88A



SI-MS-01-89
SI-MS-01-89A

200 mm
225 mm
Vannas blade



SI-MS-01-90
SI-MS-01-90A



SI-MS-01-91
SI-MS-01-91A

200 mm
225 mm
Dissector blade, blunt

Pinces à fixation – Dilatateurs vasculaires
 Fixation forceps – Vascular dilators
 Pinzas de fixaciòn – Dilatadores vasculares
 Pinze di fissaggio – Pinze per allargare i vasi



Typ Juwelier



Pinces à fixation – Dilatateurs vasculaires
 Fixation forceps – Vascular dilators
 Pinzas de fixaciòn – Dilatadores vasculares
 Pinze di fissaggio – Pinze per allargare i vasi

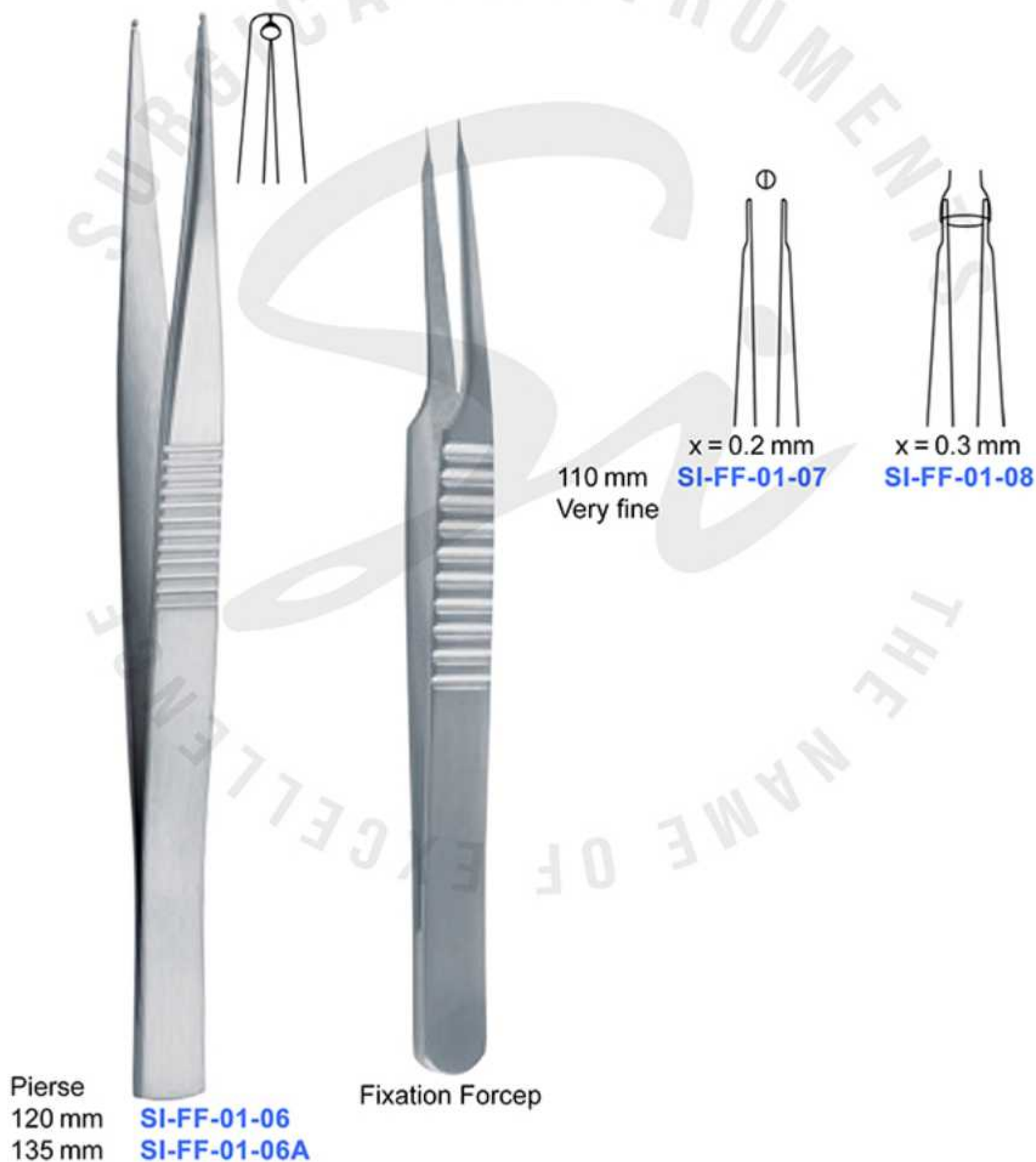

Micro pinces pour sutures
Micro suture tying forceps
Micro pinzas para suturas
Pinze per micro-suture



Lazar

155 mm



0.5 mm

SI-MF-03-01



0.8 mm

SI-MF-03-02

Micro pinces pour sutures
Micro suture tying forceps
Micro pinzas para suturas
Pinze per micro-suture

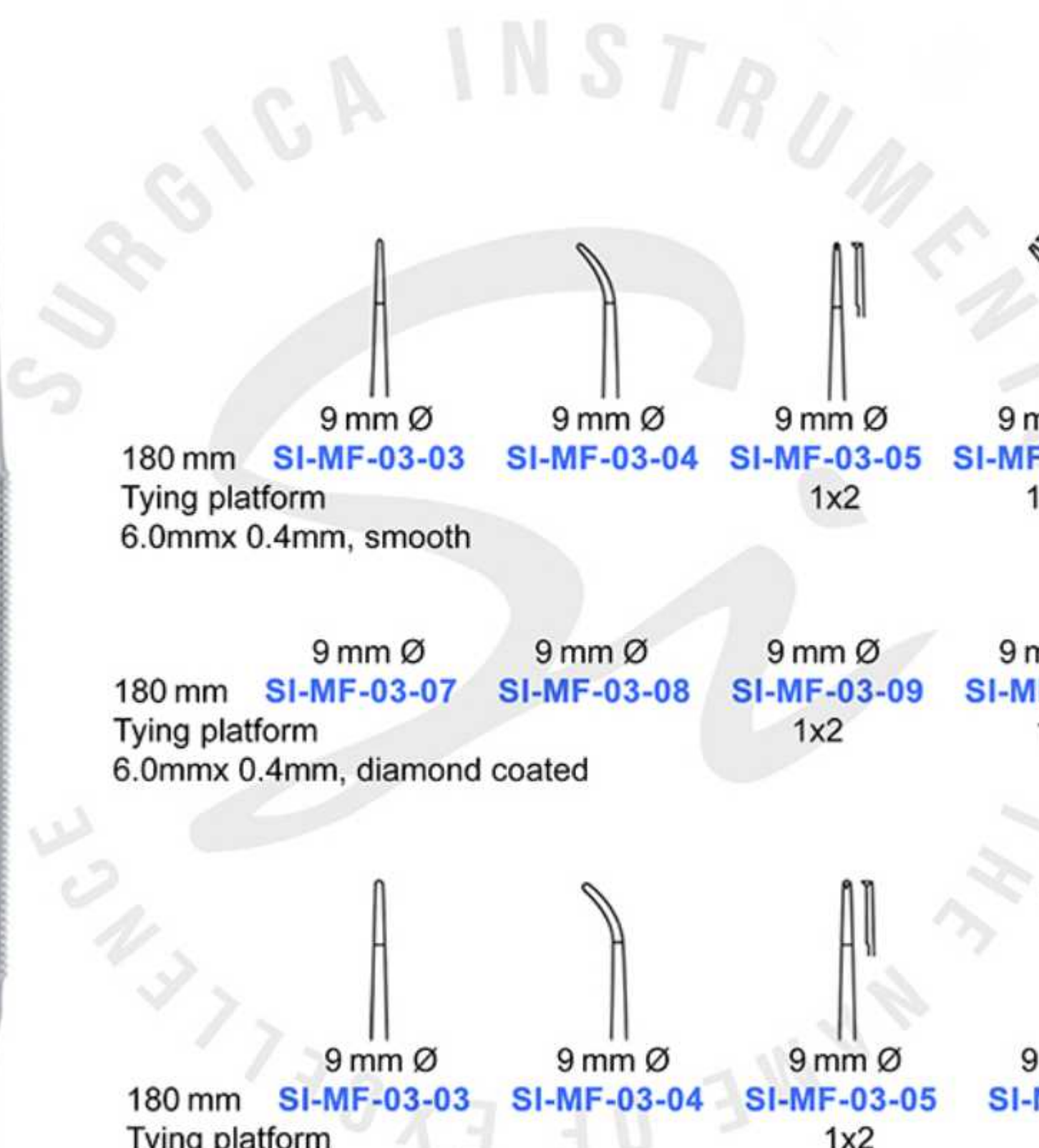

9 mm Ø 9 mm Ø 9 mm Ø 9 mm Ø

180 mm **SI-MF-03-03** **SI-MF-03-04** **SI-MF-03-05** **SI-MF-03-06**
Tying platform 1x2 1x2
6.0mmx 0.4mm, smooth

9 mm Ø 9 mm Ø 9 mm Ø 9 mm Ø

180 mm **SI-MF-03-07** **SI-MF-03-08** **SI-MF-03-09** **SI-MF-03-10**
Tying platform 1x2 1x2
6.0mmx 0.4mm, diamond coated

9 mm Ø 9 mm Ø 9 mm Ø 9 mm Ø

180 mm **SI-MF-03-03** **SI-MF-03-04** **SI-MF-03-05** **SI-MF-03-06**
Tying platform 1x2 1x2
6.0mmx 0.8mm, smooth

9 mm Ø 9 mm Ø 9 mm Ø 9 mm Ø

180 mm **SI-MF-03-07** **SI-MF-03-08** **SI-MF-03-09** **SI-MF-03-10**
Tying platform 1x2 1x2
6.0mmx 0.8mm, diamond coated

Micro pincers
Micro forceps
Micro pinzas
Pinze per microchirurgia







	0.3 mm	0.3 mm	0.7 mm	0.7 mm
8 mm Ø				
150 mm	SI-MF-04-01	SI-MF-04-02	SI-MF-04-03	SI-MF-04-04
180 mm	SI-MF-04-01A	SI-MF-04-02A	SI-MF-04-03A	SI-MF-04-04A
210 mm	SI-MF-04-01B	SI-MF-04-02B	SI-MF-04-03B	SI-MF-04-04B
230 mm	SI-MF-04-01C	SI-MF-04-02C	SI-MF-04-03C	SI-MF-04-04C
Jaw smooth				

	0.3 mm	0.3 mm	0.7 mm	0.7 mm
8 mm Ø				
150 mm	SI-MF-04-05	SI-MF-04-06	SI-MF-04-07	SI-MF-04-08
180 mm	SI-MF-04-05A	SI-MF-04-06A	SI-MF-04-07A	SI-MF-04-08A
210 mm	SI-MF-04-05B	SI-MF-04-06B	SI-MF-04-07B	SI-MF-04-08B
230 mm	SI-MF-04-05C	SI-MF-04-06C	SI-MF-04-07C	SI-MF-04-08C
Tying platform			1x2	1x2
6.0mmx 0.3mm, smooth				





	0.3 mm	0.3 mm	0.7 mm	0.7 mm
8 mm Ø				
150 mm	SI-MF-04-09	SI-MF-04-10	SI-MF-04-11	SI-MF-04-12
180 mm	SI-MF-04-09A	SI-MF-04-10A	SI-MF-04-11A	SI-MF-04-12A
210 mm	SI-MF-04-09B	SI-MF-04-10B	SI-MF-04-11B	SI-MF-04-12B
230 mm	SI-MF-04-09C	SI-MF-04-10C	SI-MF-04-11C	SI-MF-04-12C
Tying platform			1x2	1x2
6.0mmx 0.7mm, smooth				

Micro pincers
Micro forceps
Micro pinzas
Pinze per microchirurgia







				
8 mm Ø	0.3 mm	0.3 mm	0.7 mm	0.7 mm
150 mm	SI-MF-04-13	SI-MF-04-14	SI-MF-04-15	SI-MF-04-16
180 mm	SI-MF-04-13A	SI-MF-04-14A	SI-MF-04-15A	SI-MF-04-16A
210 mm	SI-MF-04-13B	SI-MF-04-14B	SI-MF-04-15B	SI-MF-04-16B
230 mm	SI-MF-04-13C	SI-MF-04-14C	SI-MF-04-15C	SI-MF-04-16C

Diamond coated

				
8 mm Ø	0.3 mm	0.3 mm	0.7 mm	0.7 mm
150 mm	SI-MF-04-17	SI-MF-04-18	SI-MF-04-19	SI-MF-04-20
180 mm	SI-MF-04-17A	SI-MF-04-18A	SI-MF-04-19A	SI-MF-04-20A
210 mm	SI-MF-04-17B	SI-MF-04-18B	SI-MF-04-19B	SI-MF-04-20B
230 mm	SI-MF-04-17C	SI-MF-04-18C	SI-MF-04-19C	SI-MF-04-20C

Tying platform
6.0mmx 0.3mm, diamond coated

				
8 mm Ø	0.3 mm	0.3 mm	0.7 mm	0.7 mm
150 mm	SI-MF-04-21	SI-MF-04-22	SI-MF-04-23	SI-MF-04-24
180 mm	SI-MF-04-21A	SI-MF-04-22A	SI-MF-04-23A	SI-MF-04-24A
210 mm	SI-MF-04-21B	SI-MF-04-22B	SI-MF-04-23B	SI-MF-04-24B
230 mm	SI-MF-04-21C	SI-MF-04-22C	SI-MF-04-23C	SI-MF-04-24C

Tying platform
6.0mmx 0.7mm, diamond coated

Micro pincers
Micro forceps
Micro pinzas
Pinze per microchirurgia







	0.4 mm	0.4 mm	0.8 mm	0.8 mm
8 mm Ø				
150 mm	SI-MF-04-25	SI-MF-04-26	SI-MF-04-27	SI-MF-04-28
180 mm	SI-MF-04-25A	SI-MF-04-26A	SI-MF-04-27A	SI-MF-04-28A
210 mm	SI-MF-04-25B	SI-MF-04-26B	SI-MF-04-27B	SI-MF-04-28B
230 mm	SI-MF-04-25C	SI-MF-04-26C	SI-MF-04-27C	SI-MF-04-28C
Jaw smooth				





	0.4 mm	0.4 mm	0.8 mm	0.8 mm
8 mm Ø				
150 mm	SI-MF-04-29	SI-MF-04-30	SI-MF-04-31	SI-MF-04-32
180 mm	SI-MF-04-29A	SI-MF-04-30A	SI-MF-04-31A	SI-MF-04-32A
210 mm	SI-MF-04-29B	SI-MF-04-30B	SI-MF-04-31B	SI-MF-04-32B
230 mm	SI-MF-04-29C	SI-MF-04-30C	SI-MF-04-31C	SI-MF-04-32C
Tying platform 6.0mm				





	0.4 mm	0.4 mm	0.8 mm	0.8 mm
8 mm Ø				
150 mm	SI-MF-04-33	SI-MF-04-34	SI-MF-04-35	SI-MF-04-36
180 mm	SI-MF-04-33A	SI-MF-04-34A	SI-MF-04-35A	SI-MF-04-36A
210 mm	SI-MF-04-33B	SI-MF-04-34B	SI-MF-04-35B	SI-MF-04-36B
230 mm	SI-MF-04-33C	SI-MF-04-34C	SI-MF-04-35C	SI-MF-04-36C
Tying platform 6.0mm/ 1 x 2 teeth				

Micro pincers
Micro forceps
Micro pinzas
Pinze per microchirurgia



				
8 mm Ø	0.4 mm	0.4 mm	0.8 mm	0.8 mm
150 mm	SI-MF-04-37	SI-MF-04-38	SI-MF-04-39	SI-MF-04-40
180 mm	SI-MF-04-37A	SI-MF-04-38A	SI-MF-04-39A	SI-MF-04-40A
210 mm	SI-MF-04-37B	SI-MF-04-38B	SI-MF-04-39B	SI-MF-04-40B
230 mm	SI-MF-04-37C	SI-MF-04-38C	SI-MF-04-39C	SI-MF-04-40C
Diamond coated				

				
8 mm Ø	0.4 mm	0.4 mm	0.8 mm	0.8 mm
150 mm	SI-MF-04-41	SI-MF-04-42	SI-MF-04-43	SI-MF-04-44
180 mm	SI-MF-04-41A	SI-MF-04-42A	SI-MF-04-43A	SI-MF-04-44A
210 mm	SI-MF-04-41B	SI-MF-04-42B	SI-MF-04-43B	SI-MF-04-44B
230 mm	SI-MF-04-41C	SI-MF-04-42C	SI-MF-04-43C	SI-MF-04-44C
Tying platform 6.0mm, diamond coated				

				
8 mm Ø	0.4 mm	0.4 mm	0.8 mm	0.8 mm
150 mm	SI-MF-04-45	SI-MF-04-46	SI-MF-04-47	SI-MF-04-48
180 mm	SI-MF-04-45A	SI-MF-04-46A	SI-MF-04-47A	SI-MF-04-48A
210 mm	SI-MF-04-45B	SI-MF-04-46B	SI-MF-04-47B	SI-MF-04-48B
230 mm	SI-MF-04-45C	SI-MF-04-46C	SI-MF-04-47C	SI-MF-04-48C
Tying platform 6.0mm/ 1 x 2 teeth, diamond coated				

Micro pincers
Micro forceps
Micro pinzas
Pinze per microchirurgia



Jacobson
160 mm
180 mm

SI-MF-04-49
SI-MF-04-49A
Straight, sharp

SI-MF-04-50
SI-MF-04-50A
Straight, blunt

Micro pincers
Micro forceps
Micro pinzas
Pinze per microchirurgia



Yasargil
3.0 mm
5.0 mm

225 mm
SI-MF-04-51
SI-MF-04-51A
Spoon form

225 mm
SI-MF-04-52
SI-MF-04-52A
Plan toothed

225 mm
SI-MF-04-53
SI-MF-04-53A
Curette form

Micro pincers
Micro forceps
Micro pinzas
Pinze per microchirurgia



200 mm
225 mm
Diamond
coated

SI-MF-04-54
SI-MF-04-54A
Straight
sharp

SI-MF-04-55
SI-MF-04-55A
Straight
blunt

Micro forcep

Micro pincers
Micro forceps
Micro pinzas
Pinze per microchirurgia



MICRO- & NEURO SURGERY

Micro pinces avec anneaux
Micro ring forceps
Micro pinzas con anillos
Micro pinze con anelli



9 mm Ø	1.0 x 0.5 mm	1.0 x 0.5 mm	2.0 x 1.0 mm	2.0 x 1.0 mm	1.0 x 0.5 mm	2.0 x 1.0 mm
150 mm	SI-RF-04-01	SI-RF-04-02	SI-RF-04-03	SI-RF-04-04	SI-RF-04-05	SI-RF-04-06
180 mm	SI-RF-04-01A	SI-RF-04-02A	SI-RF-04-03A	SI-RF-04-04A	SI-RF-04-05A	SI-RF-04-06A
210 mm	SI-RF-04-01B	SI-RF-04-02B	SI-RF-04-03B	SI-RF-04-04B	SI-RF-04-05B	SI-RF-04-06B
230 mm	SI-RF-04-01C	SI-RF-04-02C	SI-RF-04-03C	SI-RF-04-04C	SI-RF-04-05C	SI-RF-04-06C
	Smooth	Slightly serrated	Smooth	Slightly serrated	Diamond coated	Diamond coated
9 mm Ø	1.0 x 0.5 mm	1.0 x 0.5 mm	2.0 x 1.0 mm	2.0 x 1.0 mm	1.0 x 0.5 mm	2.0 x 1.0 mm
150 mm	SI-RF-04-07	SI-RF-04-08	SI-RF-04-09	SI-RF-04-10	SI-RF-04-11	SI-RF-04-12
180 mm	SI-RF-04-07A	SI-RF-04-08A	SI-RF-04-09A	SI-RF-04-10A	SI-RF-04-11A	SI-RF-04-12A
210 mm	SI-RF-04-07B	SI-RF-04-08B	SI-RF-04-09B	SI-RF-04-10B	SI-RF-04-11B	SI-RF-04-12B
230 mm	SI-RF-04-07C	SI-RF-04-08C	SI-RF-04-09C	SI-RF-04-10C	SI-RF-04-11C	SI-RF-04-12C
	Smooth	Slightly serrated	Smooth	Slightly serrated	Diamond coated	Diamond coated

Micro pinces avec anneaux
Micro ring forceps
Micro pinzas con anillos
Micro pinze con anelli



9 mm Ø
210 mm
230 mm

1.0 mm x 0.5 mm
SI-RF-04-13
SI-RF-04-13A
Smooth

1.0 mm x 0.5 mm
SI-RF-04-14
SI-RF-04-14A
Serrated

2.0 mm x 1.0 mm
SI-RF-04-15
SI-RF-04-15A
Smooth

2.0 mm x 1.0 mm
SI-RF-04-16
SI-RF-04-16A
Serrated

9 mm Ø
210 mm
230 mm
Diamond coated

1.0 mm x 0.5 mm
SI-RF-04-17
SI-RF-04-17A

1.0 mm x 0.5 mm
SI-RF-04-18
SI-RF-04-18A

Micro pinces atraumatiques
Atraumatic micro forceps
Micro pinces atraumaticas
Micro pinze atraumatiche



150 mm
180 mm
210 mm
230 mm



x = 1.2 mm
SI-MF-2-01
SI-MF-2-01A
SI-MF-2-01B
SI-MF-2-01C
Straight



x = 2.0 mm
SI-MF-2-02
SI-MF-2-02A
SI-MF-2-02B
SI-MF-2-02C
Straight



x = 1.5 mm
SI-MF-2-03
SI-MF-2-03A
SI-MF-2-03B
SI-MF-2-03C
Angled



x = 2.0 mm
SI-MF-2-04
SI-MF-2-04A
SI-MF-2-04B
SI-MF-2-04C
Angled

Micro porte aiguilles
Micro needle holders
Micro porta agujas
Micro porta aghi



Castroviejo
x = 11.0 x 0.75 mm
140 mm – 5 1/2"
Without ratchet
fine jaws

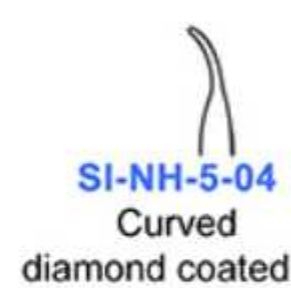



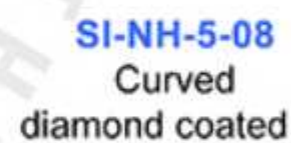
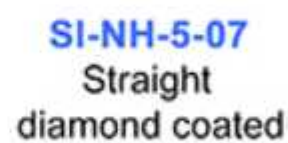









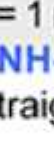



Castroviejo
x = 11.0 x 0.75 mm
140 mm – 5 1/2"
With ratchet
fine jaws

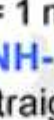

Micro porte aiguilles
Micro needle holders
Micro porta agujas
Micro porta aghi

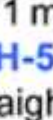

Jacobson 180 mm – 7" Without ratchet	 x = 1 mm SI-NH-5-09 Straight	 x = 1 mm SI-NH-5-10 Curved	 x = 1 mm SI-NH-5-11 Straight diamond coated	 x = 1 mm SI-NH-5-12 Curved diamond coated
Jacobson 180 mm – 7" With ratchet	 x = 1 mm SI-NH-5-13 Straight	 x = 1 mm SI-NH-5-14 Curved	 x = 1 mm SI-NH-5-15 Straight diamond coated	 x = 1 mm SI-NH-5-16 Curved diamond coated
Jacobson 180 mm – 7" Without ratchet	 x = 1 mm SI-NH-5-17 Straight Smooth	 x = 1 mm SI-NH-5-18 Curved Smooth	 x = 1 mm SI-NH-5-19 Straight Serrated	 x = 1 mm SI-NH-5-20 Curved Serrated
Jacobson 180 mm – 7" With ratchet	 x = 1 mm SI-NH-5-21 Straight Smooth	 x = 1 mm SI-NH-5-22 Curved Smooth	 x = 1 mm SI-NH-5-23 Straight Serrated	 x = 1 mm SI-NH-5-24 Curved Serrated

Micro porte aiguilles
Micro needle holders
Micro porta agujas
Micro porta aghi



Yasargil
180 mm
200 mm
Without ratchet

SI-NH-5-25
SI-NH-5-25A
Straight

SI-NH-5-26
SI-NH-5-26A
Curved

SI-NH-5-27
SI-NH-5-27A
Straight
diamond coated

SI-NH-5-28
SI-NH-5-28A
Curved
diamond coated

Yasargil
180 mm
200 mm
With ratchet

SI-NH-5-29
SI-NH-5-29A
Straight

SI-NH-5-30
SI-NH-5-30A
Curved

SI-NH-5-31
SI-NH-5-31A
Straight
diamond coated

SI-NH-5-32
SI-NH-5-32A
Curved
diamond coated

Micro porte aiguilles
Micro needle holders
Micro porta agujas
Micro porta aghi



Yasargil

210 mm
Without ratchet

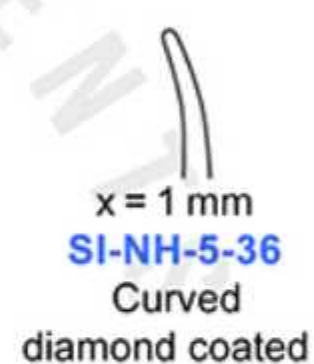
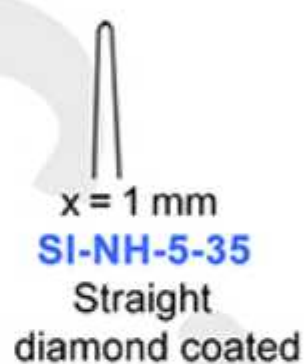
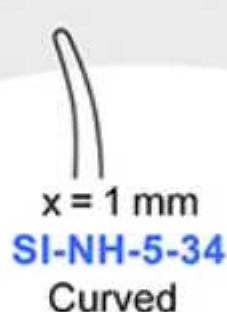
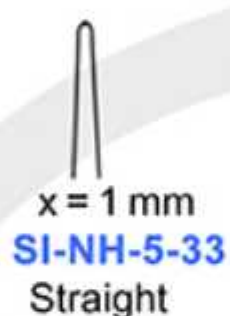

Yasargil

210 mm
With ratchet

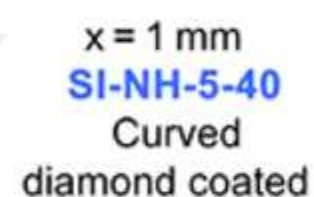
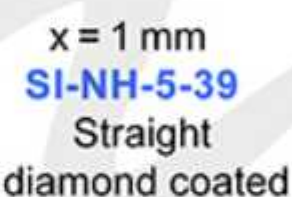
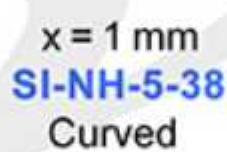
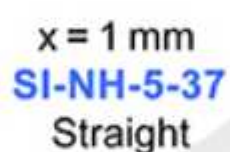

Yasargil

210 mm
Without ratchet

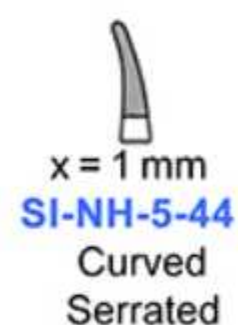
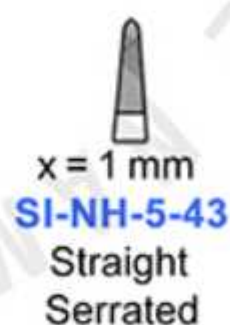
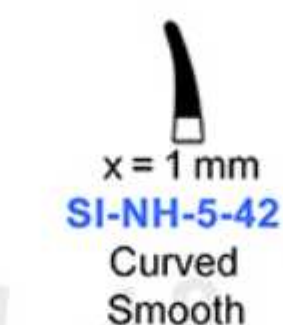
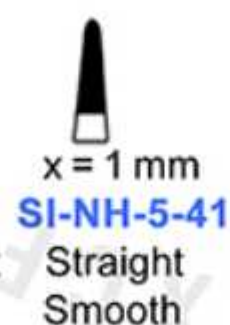

Yasargil

210 mm
With ratchet

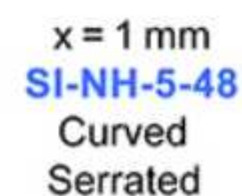
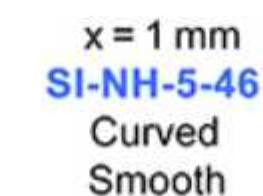
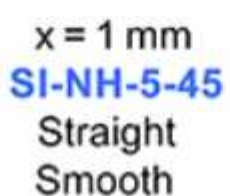

Micro porte aiguilles
Micro needle holders
Micro porta agujas
Micro porta aghi



Micro needle holder

			
110 mm	8 mm Ø	SI-NH-5-49	SI-NH-5-50
125 mm	7 mm Ø	SI-NH-5-49A	SI-NH-5-50A
130 mm	8 mm Ø	SI-NH-5-49B	SI-NH-5-50B
130 mm	10 mm Ø	SI-NH-5-49C	SI-NH-5-50C
150 mm	8 mm Ø	SI-NH-5-49D	SI-NH-5-50D
180 mm	8 mm Ø	SI-NH-5-49E	SI-NH-5-50E
180 mm	10 mm Ø	SI-NH-5-49F	SI-NH-5-50F
Without ratchet		Straight	Curved
110 mm	8 mm Ø	SI-NH-5-51	SI-NH-5-52
125 mm	7 mm Ø	SI-NH-5-51A	SI-NH-5-52A
130 mm	8 mm Ø	SI-NH-5-51B	SI-NH-5-52B
130 mm	10 mm Ø	SI-NH-5-51C	SI-NH-5-52C
150 mm	8 mm Ø	SI-NH-5-51D	SI-NH-5-52D
180 mm	8 mm Ø	SI-NH-5-51E	SI-NH-5-52E
180 mm	10 mm Ø	SI-NH-5-51F	SI-NH-5-52F
With ratchet		Straight	Curved

Micro porte aiguilles
Micro needle holders
Micro porta agujas
Micro porta aghi



Barraquer
140 mm 8 mm Ø
Without ratchet
extra delicate jaws

SI-NH-5-53
Straight



SI-NH-5-54
Curved



SI-NH-5-55
Straight
diamond coated



SI-NH-5-56
Curved
diamond coated



Barraquer
140 mm 8 mm Ø
With ratchet
extra delicate jaws

SI-NH-5-57
Straight

SI-NH-5-58
Curved

SI-NH-5-59
Straight
diamond coated

SI-NH-5-60
Curved
diamond coated

Micro porte aiguilles
Micro needle holders
Micro porta agujas
Micro porta aghi



180 mm
Titanium, with ratchet

0.3 mm x 0.4 mm
SI-NH-5-61

0.3 mm x 0.4 mm
SI-NH-5-62

Micro needle holder

Micro porte aiguilles
Micro needle holders
Micro porta agujas
Micro porta aghi



185 mm
Titanium, with ratchet

0.8 mm x 0.8 mm
SI-NH-5-63

0.8 mm x 0.8 mm
SI-NH-5-64

Micro needle holder

Micro porte aiguilles
Micro needle holders
Micro porta agujas
Micro porta aghi



200 mm
Titanium, with ratchet



0.5 mm x 0.8 mm
SI-NH-5-65



0.5 mm x 0.8 mm
SI-NH-5-66

Micro needle holder

Micro porte aiguilles
Micro needle holders
Micro porta agujas
Micro porta aghi



Micro needle holder

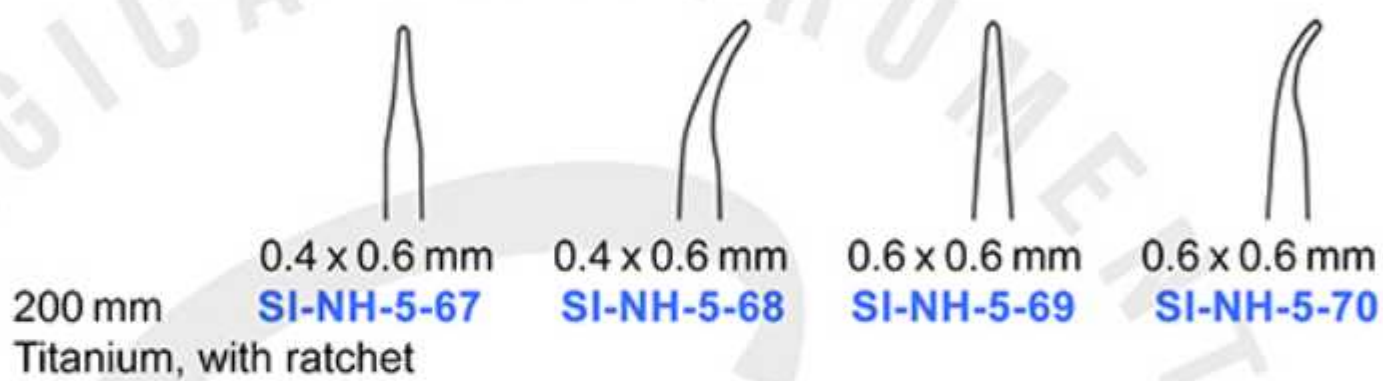

Micro porte aiguilles
Micro needle holders
Micro porta agujas
Micro porta aghi

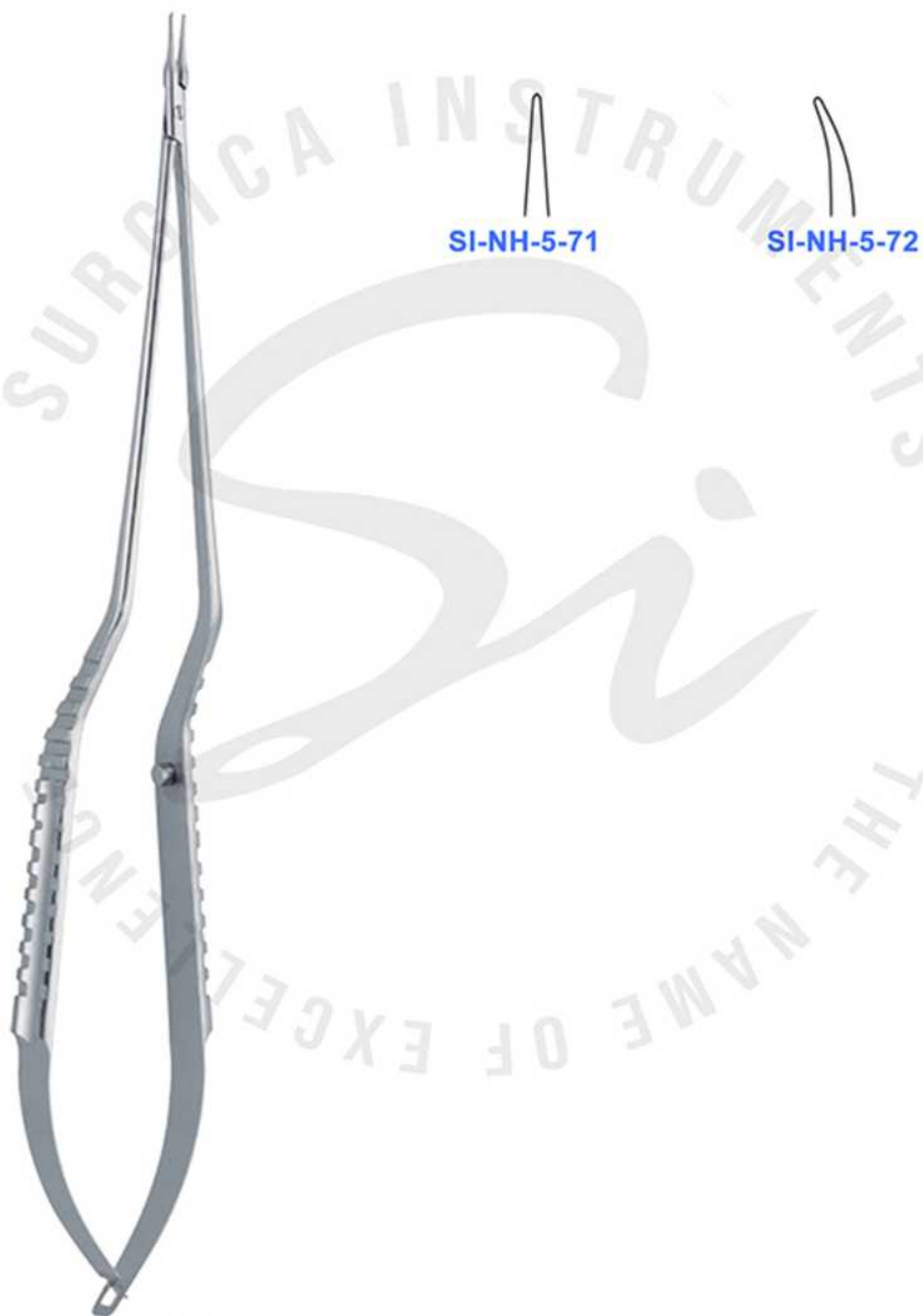

Micro needle holder
225 mm – 8 3/4 "

Micro porte aiguilles
Micro needle holders
Micro porta agujas
Micro porta aghi



200 mm
225 mm
240 mm
without
ratchet

200 mm
225 mm
240 mm
without
ratchet
diamond
coated

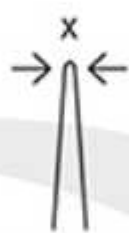

x = 0.4 mm
SI-NH-5-73
SI-NH-5-73A
SI-NH-5-73B
Straight



x = 0.4 mm
SI-NH-5-74
SI-NH-5-74A
SI-NH-5-74B
Curved

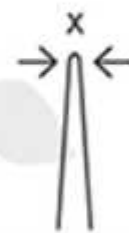

x = 0.9 mm
SI-NH-5-75
SI-NH-5-75A
SI-NH-5-75B
Straight



x = 0.9 mm
SI-NH-5-76
SI-NH-5-76A
SI-NH-5-76B
Curved

x = 0.4 mm
SI-NH-5-77
SI-NH-5-77A
SI-NH-5-77B
Straight

x = 0.4 mm
SI-NH-5-78
SI-NH-5-78A
SI-NH-5-78B
Curved

x = 0.9 mm
SI-NH-5-79
SI-NH-5-79A
SI-NH-5-79B
Straight

x = 0.9 mm
SI-NH-5-80
SI-NH-5-80A
SI-NH-5-80B
Curved

Micro needle holder

Micro porte aiguilles
Micro needle holders
Micro porta agujas
Micro porta aghi



Jacobson
180 mm
Without ratchet

SI-NH-5-81
Straight

SI-NH-5-82
Curved

SI-NH-5-83
Straight
diamond coated

SI-NH-5-84
Curved
diamond coated

Jacobson
180 mm
With ratchet

SI-NH-5-85
Straight

SI-NH-5-86
Curved









SI-NH-5-87
Straight
diamond coated

SI-NH-5-88
Curved
diamond coated

Micro porte aiguilles
Micro needle holders
Micro porta agujas
Micro porta aghi



Micro needle holder

9 mm Ø 230 mm without ratchet		x = 1.0 mm SI-NH-5-89 Straight		x = 1.0 mm SI-NH-5-90 Curved		x = 1.0 mm SI-NH-5-91 Straight diamond coated		x = 1.0 mm SI-NH-5-92 Curved diamond coated		
	9 mm Ø 230 mm with ratchet	x = 1.0 mm SI-NH-5-93 Straight	x = 1.0 mm SI-NH-5-94 Curved	x = 1.0 mm SI-NH-5-95 Straight diamond coated	x = 1.0 mm SI-NH-5-96 Curved diamond coated					
		9 mm Ø 230 mm without ratchet		SI-NH-5-97 Straight smooth		SI-NH-5-98 Curved smooth		SI-NH-5-99 Straight serrated		SI-NH-5-100 Curved serrated
			9 mm Ø 230 mm with ratchet	SI-NH-5-101 Straight smooth	SI-NH-5-102 Curved smooth	SI-NH-5-103 Straight serrated	SI-NH-5-104 Curved serrated			

Si **SURGICA**
INSTRUMENTS
THE NAME OF EXCELLENCE



SUTURE INSTRUMENTS



Instruments à suture
Suture instruments
Instrumentos para sutura
Strumenti per sutura



Reverdin

150 mm
195 mm
225 mm



Fig. 1

SI-RN-1-01
SI-RN-1-01A
SI-RN-1-01B



Fig. 2

SI-RN-1-02
SI-RN-1-02A
SI-RN-1-02B



Fig. 3

SI-RN-1-03
SI-RN-1-03A
SI-RN-1-03B



Fig. 4

SI-RN-1-04
SI-RN-1-04A
SI-RN-1-04B



Flexible
200 mm – 8"
SI-RN-1-05



Cooper
190 mm – 7 1/2"
SI-RN-1-06



Instruments à suture
Suture instruments
Instrumentos para sutura
Strumenti per sutura

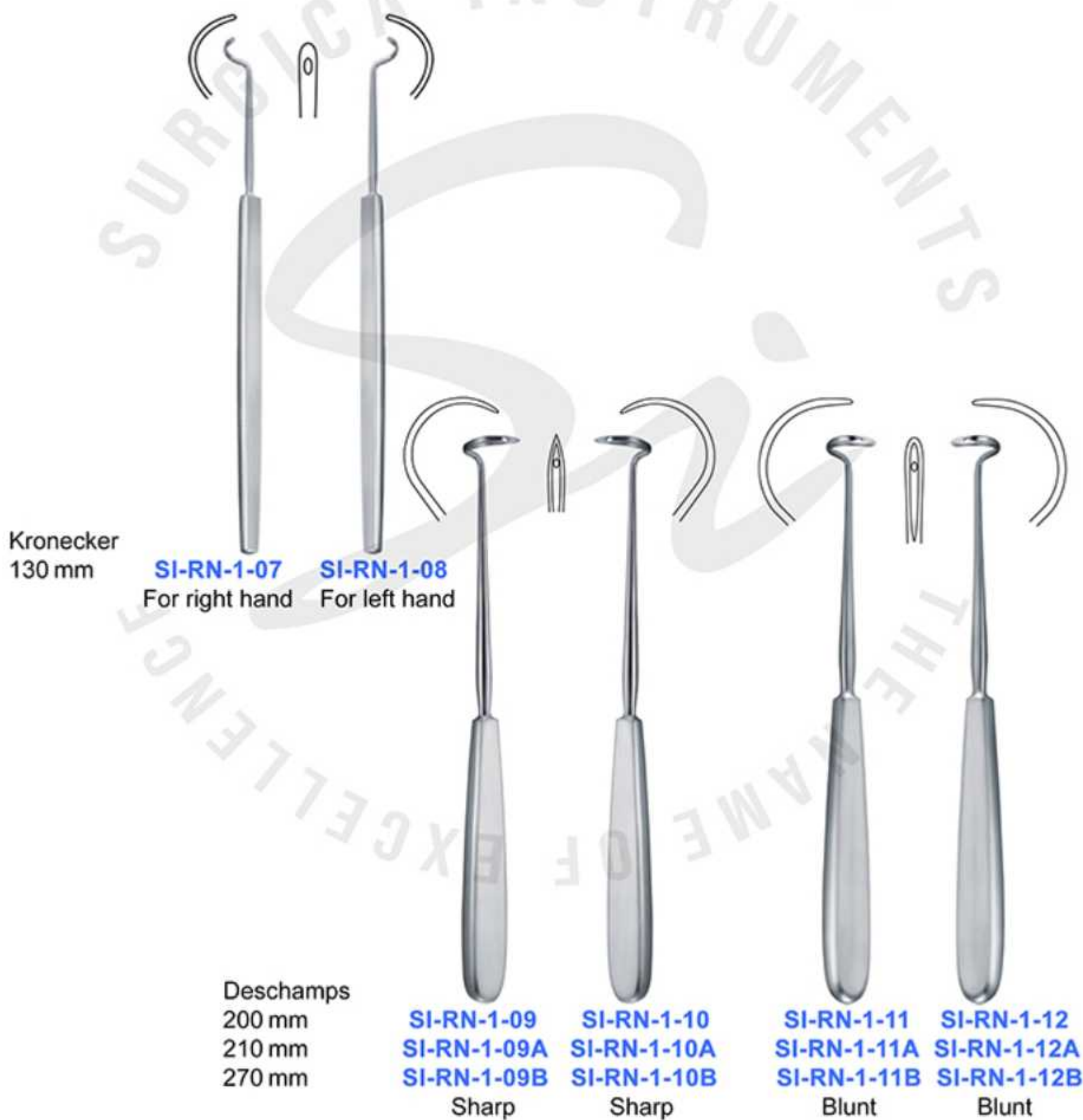

Instruments à suture
Suture instruments
Instrumentos para sutura
Strumenti per sutura



Instruments à suture
Suture instruments
Instrumentos para sutura
Strumenti per sutura

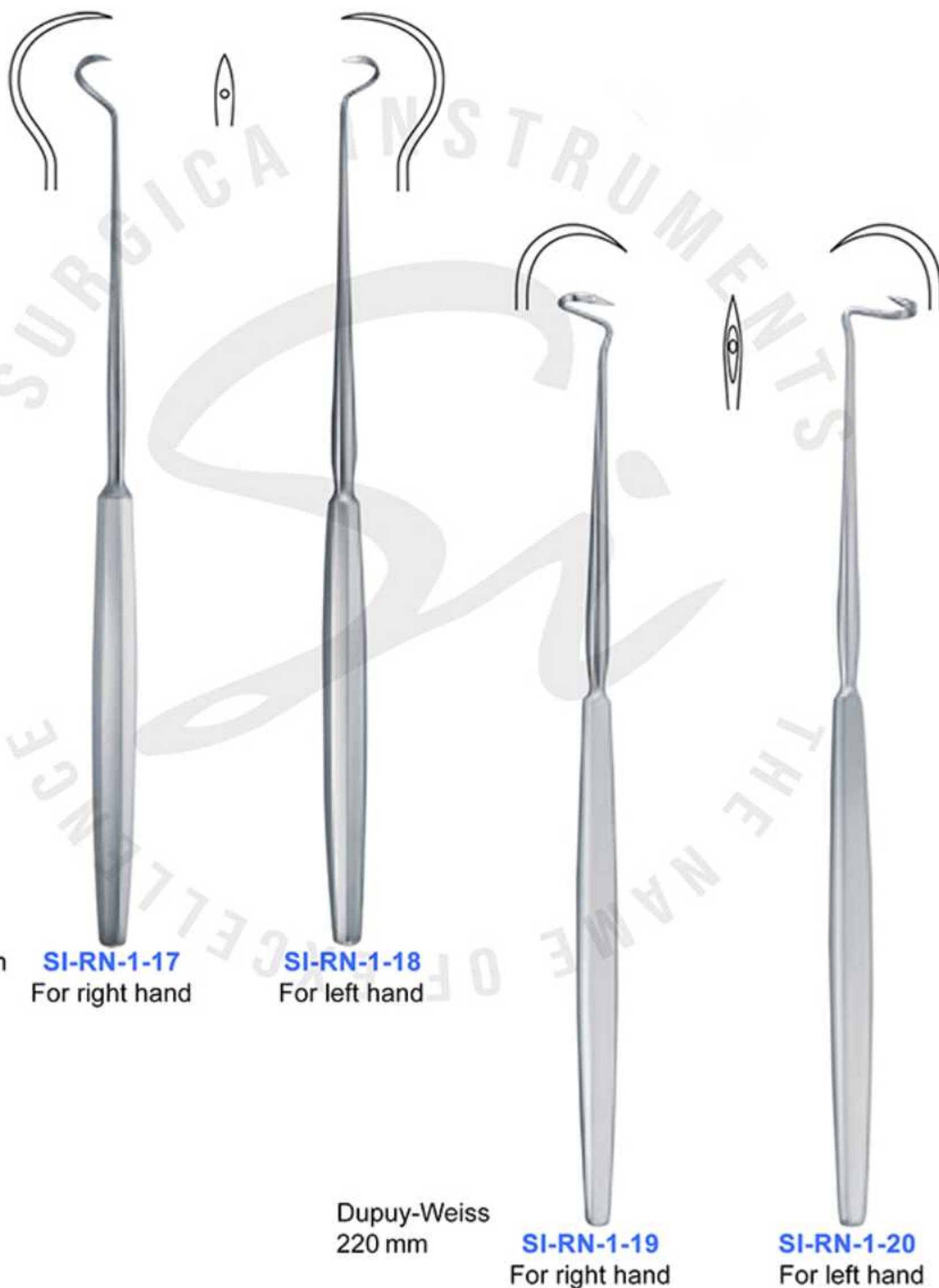

Instruments à suture
Suture instruments
Instrumentos para sutura
Strumenti per sutura

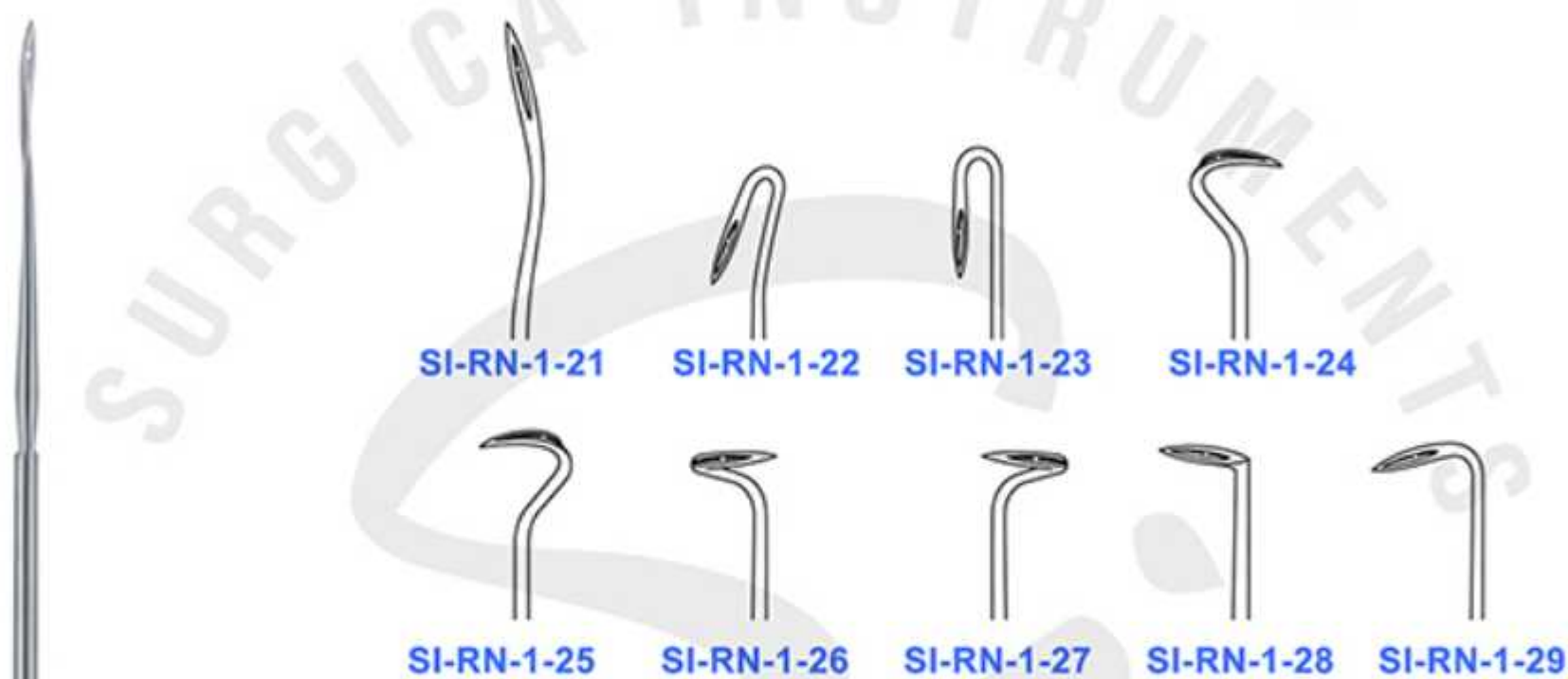

Yankauer
170 mm – 6 3/4"
Septum suture needles

Nager
240 mm – 9 1/2"
SI-RN-1-30

Falk
240 mm



SI-RN-1-31
For right hand

SI-RN-1-32
For left hand

Instruments à suture
Suture instruments
Instrumentos para sutura
Strumenti per sutura



Kirschner
280 m – 11"
4 mm
SI-RN-1-33



Kirschner
255 m – 10"
5 mm
SI-RN-1-34

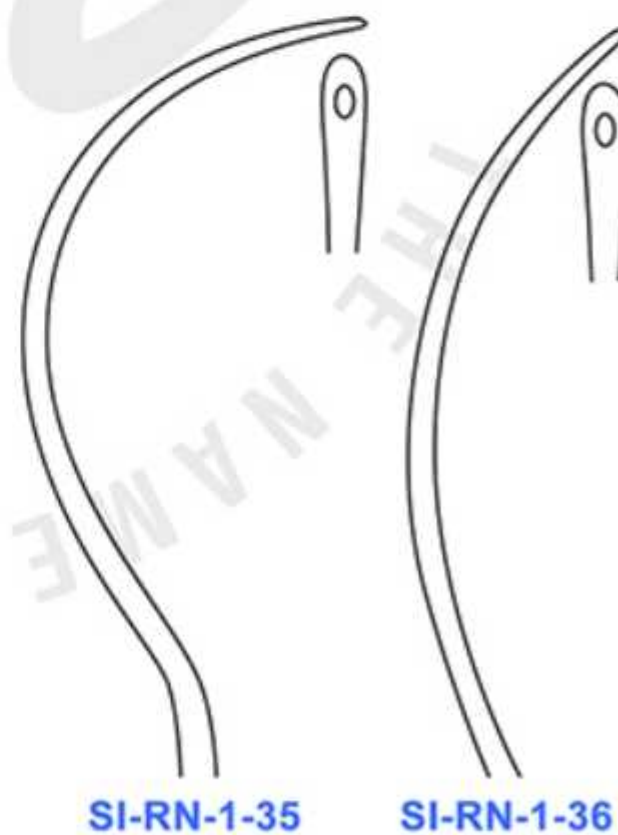

SI-RN-1-35

SI-RN-1-36



Brunner
300 mm – 12"

Instruments à suture
Suture instruments
Instrumentos para sutura
Strumenti per sutura



Instruments à suture
Suture instruments
Instrumentos para sutura
Strumenti per sutura



Brunner
180 mm
270 mm
Ferrozell

SI-RN-1-42

SI-RN-1-42A



Kirschner
270 mm – 10 3/4"
Ferrozell

SI-RN-1-43



Schmieden
190 mm – 7 1/2"
8 mm
SI-RN-1-44



Schmieden-Payr
190 mm – 7 1/2"
8 mm
SI-RN-1-45



Instruments à suture
Suture instruments
Instrumentos para sutura
Strumenti per sutura



Porte-aiguilles
Needle holders
Porta-agujas
Porta aghi



Crile-Murray
150 mm – 6"
SI-NH-701



Crile-Wood
150 mm – 6"
180 mm – 7"
SI-NH-702
SI-NH-702A



Hegar-Baumgartner
140 mm – 5 3/4"
SI-NH-703

Porte-aiguilles
Needle holders
Porta-agujas
Porta aghi



Brown
130 mm – 5" **SI-NH-704**
180 mm – 7" **SI-NH-704A**
Heavy pattern, diagonally serrated jaw



Collier
125 mm – 5" **SI-NH-705**



Derf
125 mm – 5" **SI-NH-706**



Derf
120 mm – 4 3/4" **SI-NH-707**

Porte-aiguilles
Needle holders
Porta-agujas
Porta aghi



Webster
130 mm – 5"
SI-NH-708
Smooth



Halsey
130 mm – 5"
SI-NH-709
Smooth



Halsey
130 mm – 5"
SI-NH-710
Serrated

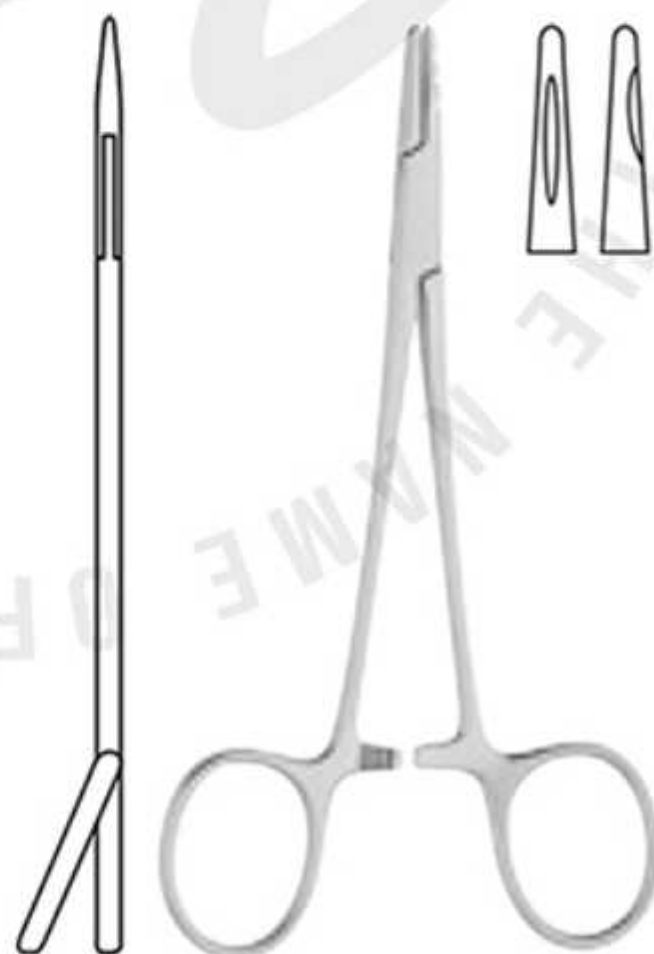

Neivert
125 mm – 5"
SI-NH-711

Porte-aiguilles
Needle holders
Porta-agujas
Porta aghi



Porte-aiguilles
Needle holders
Porta-agujas
Porta aghi



Hegar
205 mm – 8"
SI-NH-725
Heavy pattern



Heaney
160 mm – 6 1/4"
180 mm – 7"
200 mm – 8"
SI-NH-726
SI-NH-726A
SI-NH-726B



Sarot
180 mm – 7"
260 mm – 10 1/4"
SI-NH-727
SI-NH-727A



Jameson
235 mm – 9 1/4"
SI-NH-728

Porte-aiguilles
Needle holders
Porta-agujas
Porta aghi



Masson
270 mm – 10 3/4 "
SI-NH-729



Finochietto
270 mm – 10 3/4 "
SI-NH-730



Stratte
230 mm – 9 "
SI-NH-731

Porte-aiguilles
Needle holders
Porta-agujas
Porta aghi



Wangensteen
270 mm – 10 3/4 "
SI-NH-732



Bozemann (Wertheim)
200 mm – 8 " **SI-NH-733**
240 mm – 9 1/2 " **SI-NH-733A**



Thomson-Walker (Bozemann)
200 mm – 8 " **SI-NH-734**

-aiguilles
-needle holders
-agujas
-aghi



Gillies
145 mm – 5 3/4 "
SI-NH-735

Gillies
160 mm – 6 1/4 "
SI-NH-736



Olsen-Hegar
140 mm – 5 1/2 " **SI-NH-737**
170 mm – 6 3/4 " **SI-NH-737A**
190 mm – 7 1/2 " **SI-NH-737B**

Porte-aiguilles
Needle holders
Porta-agujas
Porta aghi



Mathieu
140 mm **SI-NH-738**
170 mm **SI-NH-738A**
200 mm **SI-NH-738B**
240 mm **SI-NH-738C**



Mathieu
140 mm **SI-NH-739**
170 mm **SI-NH-739A**
200 mm **SI-NH-739B**
Delicate pattern



Mathieu-Olsen
140 mm **SI-NH-740**
170 mm **SI-NH-740A**
200 mm **SI-NH-740B**







Mathieu
170 mm **SI-NH-741**
200 mm **SI-NH-741A**

Porte-aiguilles
Needle holders
Porta-agujas
Porta aghi



Castroviejo-Jacobson

				
140 mm	SI-NH-742	SI-NH-743	SI-NH-744	SI-NH-745
150 mm	SI-NH-742A	SI-NH-743A	SI-NH-744A	SI-NH-745A
180 mm	SI-NH-742B	SI-NH-743B	SI-NH-744B	SI-NH-745B
210 mm	SI-NH-742C	SI-NH-743C	SI-NH-744C	SI-NH-745C
Smooth jaws	straight without ratchet	Straight with ratchet	Curved without ratchet	Curved with ratchet

Porte-aiguilles
Needle holders
Porta-agujas
Porta aghi



Toennis
180 mm – 7"
SI-NH-746



Lichtenberg
170 mm – 6 3/4"
200 mm – 8"
SI-NH-747
SI-NH-747A



Boynton
120 mm – 4 3/4"
SI-NH-748

Porte-aiguilles
Needle holders
Porta-agujas
Porta aghi



Kalt
140 mm – 5 1/2"
SI-NH-749



Arruga
160 mm – 6 1/4"
SI-NH-750
Straight



Arruga
160 mm – 6 1/4"
SI-NH-751
Curved

TC Porte-aiguilles
TC Needle holders
TC Porta-agujas
TC Porta aghi



Hegar-Baumgartner
140 mm – 5 1/2"
SI-NH-752



Baby-Crile-Wood
150 mm – 6"
SI-NH-753



Crile-Wood
Left-hander

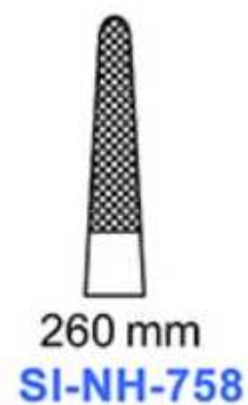
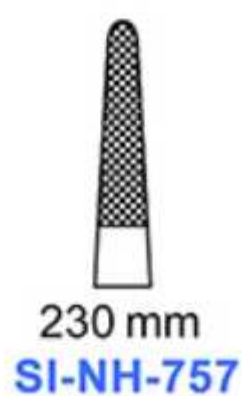
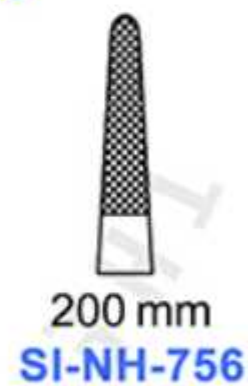
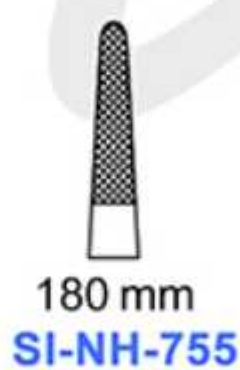

TC Porte-aiguilles
TC Needle holders
`C Porta-agujas
`C Porta aghi



Derf (Wright)
120 mm – 4 3/4 "
SI-NH-759

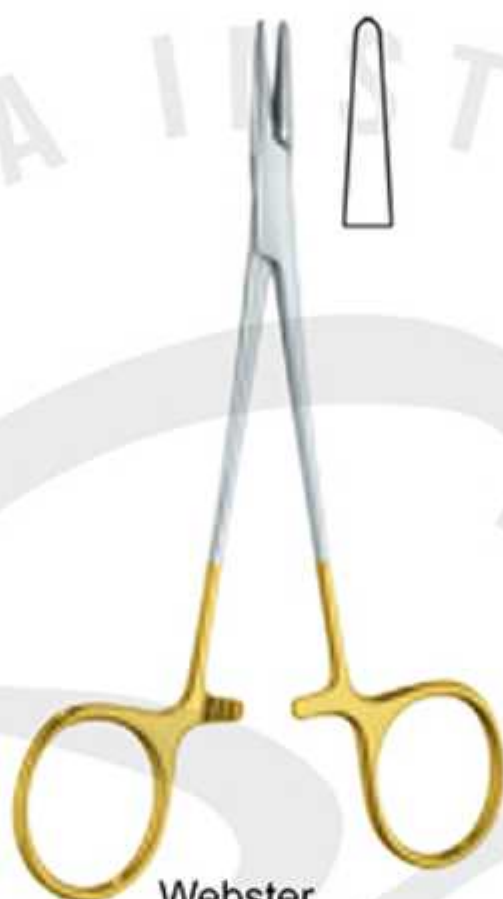

Webster
130 mm – 5 "
SI-NH-760
Smooth



Halsey
130 mm – 5 "
SI-NH-761
Smooth



Halsey
130 mm – 5 "
SI-NH-762
Serrated



Kilner
135 mm – 5 1/4 "
SI-NH-763

TC Porte-aiguilles
TC Needle holders
TC Porta-agujas
TC Porta aghi

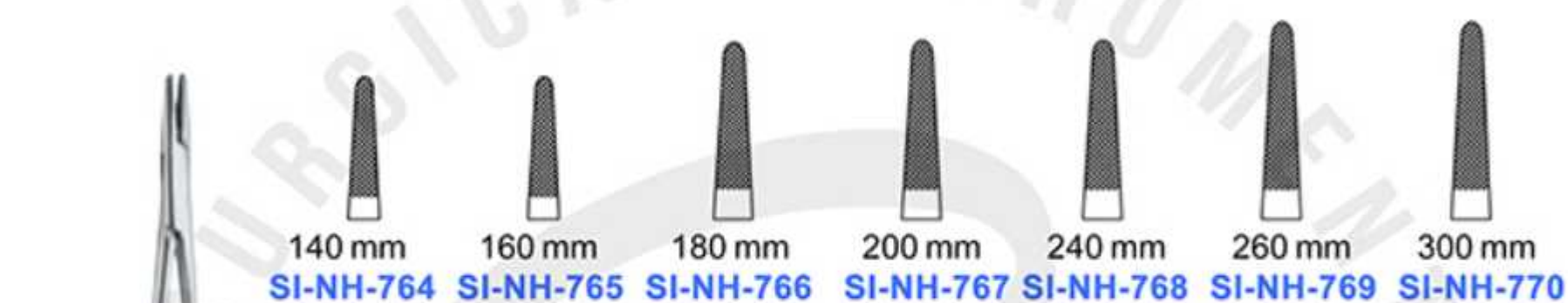

Mayo-Hegar
Left-hander



Neivert (Masing)
130 mm – 5"
SI-NH-771
One ring angled



Converse
130 mm – 5"
SI-NH-772



Mathieu-Olsen
140 mm SI-NH-773
170 mm SI-NH-773A
200 mm SI-NH-773B

TC Porte-aiguilles
TC Needle holders
TC Porta-agujas
TC Porta aghi



Hegar
205 mm – 8 "
SI-NH-774
Heavy pattern



Gillies
145 mm – 5 3/4 "
SI-NH-775



Gillies
160 mm – 6 1/4 "
SI-NH-776
Left-hander

TC Porte-aiguilles
TC Needle holders
TC Porta-agujas
TC Porta aghi



Foster-Gillies
120 mm – 43/4 "



Olsen-Hegar

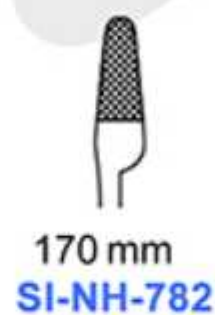
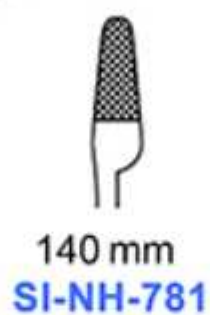

TC Porte-aiguilles
TC Needle holders
TC Porta-agujas
TC Porta aghi



Stratte
230 mm – 9"
SI-NH-784



Heaney
160 mm **SI-NH-785**
180 mm **SI-NH-785A**
200 mm **SI-NH-785B**

TC Porte-aiguilles
TC Needle holders
TC Porta-agujas
TC Porta aghi



Bozemann (Wertheim)



200 mm
SI-NH-786



240 mm
SI-NH-787



260 mm
SI-NH-788



300 mm
SI-NH-789

TC Porte-aiguilles
TC Needle holders
TC Porta-agujas
TC Porta aghi



Masson
270 mm – 10 3/4 "
SI-NH-790

Finochietto
270 mm – 10 3/4 "
SI-NH-791

Wangensteen
270 mm – 10 3/4 "
SI-NH-792

TC Porte-aiguilles
TC Needle holders
TC Porta-agujas
TC Porta aghi



Mathieu



140 mm
SI-NH-793



170 mm
SI-NH-794



200 mm
SI-NH-795



240 mm
SI-NH-796



170 mm
SI-NH-797
Heavy pattern



200 mm
SI-NH-798



140 mm
SI-NH-799
Delicate pattern



170 mm
SI-NH-800



200 mm
SI-NH-801



240 mm
SI-NH-802

TC Porte-aiguilles
TC Needle holders
TC Porta-agujas
TC Porta aghi



Mathieu
170 mm – 6 3/4" **SI-NH-803**



Mathieu
200 mm – 8" **SI-NH-804**



Lichten-
berg
170 mm – 6 3/4" **SI-NH-805**



Lichten-
berg
200 mm – 8" **SI-NH-806**

TC Porte-aiguilles
TC Needle holders
TC Porta-agujas
TC Porta aghi



Hösel
200 mm – 8 "
SI-NH-807
With long neck



Needle Holder
205 mm – 8 "
SI-NH-809
With long neck



Hösel
250 mm – 9 3/4 "
SI-NH-808

TC Porte-aiguilles
TC Needle holders
TC Porta-agujas
TC Porta aghi



Zweifel
200 mm – 8 "
SI-NH-810



Zweifel
230 mm – 9 "
SI-NH-811



Arruga
160 mm – 6 1/4 "
SI-NH-812
Straight



Arruga
160 mm – 6 1/4 "
SI-NH-813
Curved

TC Porte-aiguilles
TC Needle holders
TC Porta-agujas
TC Porta aghi



Langenbeck
180 mm **SI-NH-814**
200 mm **SI-NH-814A**
230 mm **SI-NH-814B**



Toennis
180 mm – 7" **SI-NH-815**



180 mm **SI-NH-816**



200 mm **SI-NH-817**



260 mm **SI-NH-818**



Sarot

TC Porte-aiguilles
TC Needle holders
TC Porta-agujas
TC Porta aghi



De Bakey
Left-hander

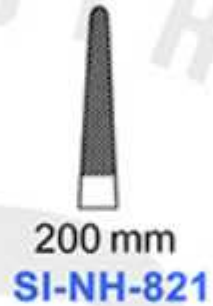
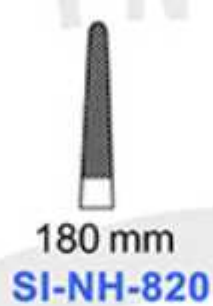
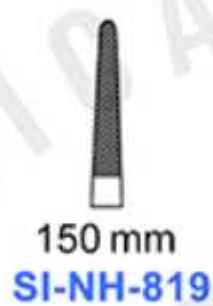

Twist
150 mm **SI-NH-824**
180 mm **SI-NH-824A**
200 mm **SI-NH-824B**
Wire forceps



Twist
150 mm **SI-NH-825**
180 mm **SI-NH-825A**
200 mm **SI-NH-825B**
Wire forceps

TC Porte-aiguilles
TC Needle holders
TC Porta-agujas
TC Porta aghi



Vascular



140 mm
SI-NH-826



180 mm
SI-NH-827



200 mm
SI-NH-828



230 mm
SI-NH-829



Ryder
130 mm **SI-NH-830**
150 mm **SI-NH-830A**
180 mm **SI-NH-830B**
200 mm **SI-NH-830C**
230 mm **SI-NH-830D**
260 mm **SI-NH-830E**



Mini-Ryder
130 mm **SI-NH-831**
150 mm **SI-NH-831A**
180 mm **SI-NH-831B**
200 mm **SI-NH-831C**
230 mm **SI-NH-831D**
260 mm **SI-NH-831E**



Diethrich
160 mm **SI-NH-832**
180 mm **SI-NH-832A**
200 mm **SI-NH-832B**
230 mm **SI-NH-832C**
250 mm **SI-NH-832D**

TC Porte-aiguilles
TC Needle holders
TC Porta-agujas
TC Porta aghi



De Bakey
230 mm – 9"
SI-NH-833



De Bakey
180 mm – 7"
SI-NH-834

TC Porte-aiguilles
TC Needle holders
TC Porta-agujas
TC Porta aghi



140 mm
150 mm
180 mm
210 mm
Smooth
jaws

Castroviejo-
Jacobson



SI-NH-835
SI-NH-835A
SI-NH-835B
SI-NH-835C
Straight
without ratchet



SI-NH-836
SI-NH-836A
SI-NH-836B
SI-NH-836C
Straight
with ratchet



SI-NH-837
SI-NH-837A
SI-NH-837B
SI-NH-837C
Curved
without ratchet



SI-NH-838
SI-NH-838A
SI-NH-838B
SI-NH-838C
Curved
with ratchet



Vascular
180 mm



SI-NH-839
Straight
without ratchet



SI-NH-840
Straight
with ratchet



SI-NH-841
Curved
without ratchet



SI-NH-842
Curved
with ratchet

TC Porte-aiguilles
TC Needle holders
TC Porta-agujas
TC Porta aghi



Castroviejo
130 mm – 5"
SI-NH-843
Straight, serrated jaws



Castroviejo
130 mm – 5"
SI-NH-844
Curved, serrated jaws



Castroviejo
130 mm – 5"
SI-NH-845
Smooth jaws



Barraquer
130 mm – 5"
SI-NH-846
Curved, with ratchet



Barraquer
130 mm – 5"
SI-NH-847
Curved, without ratchet

TC Porte-aiguilles
TC Needle holders
TC Porta-agujas
TC Porta aghi



Boynton
120 mm – 4 3/4 "
SI-NH-848



Kalt
140 mm – 5 1/2 "
SI-NH-849

Si **SURGICA**
INSTRUMENTS
THE NAME OF EXCELLENCE



VASCULAR SURGERY

- VEIN STRIPPER
- VARICOSE VEIN PROBE SET
- BULLDOG CLAMPS
- VASCULAR FORCEPS
- MULTI-PURPOSE CLAMPS
- VASCULAR DILATORS



Tire-veines
Vein stripper
Fleboextractores
Tiravene

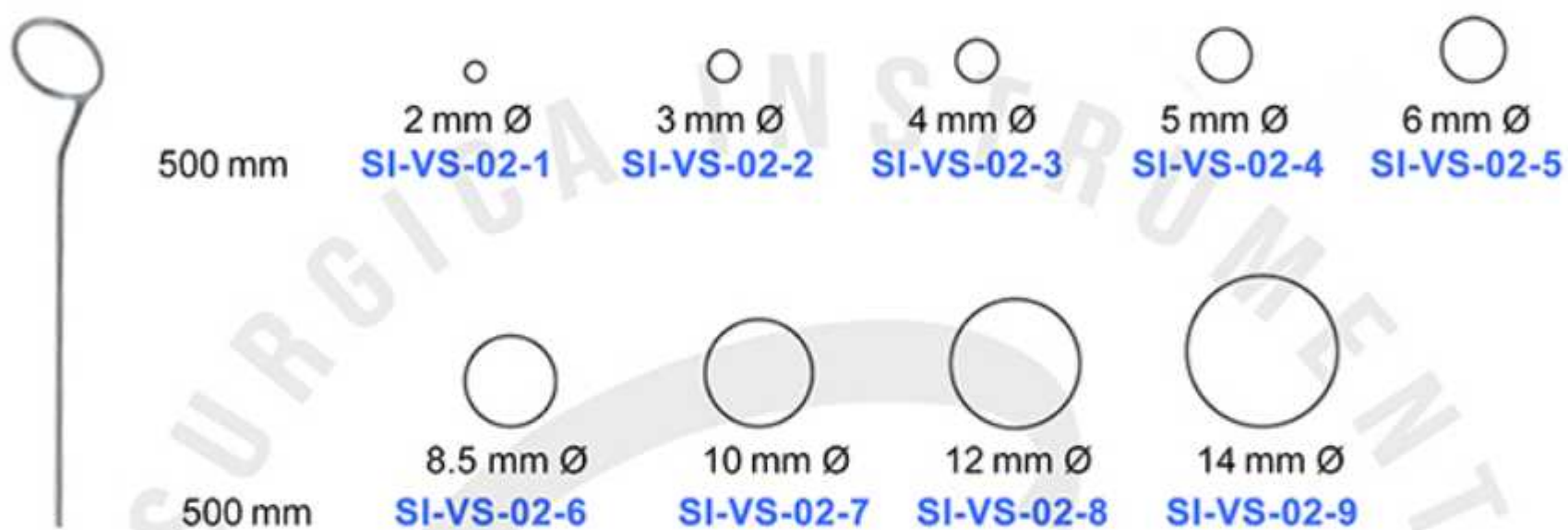

Mirror Handle
120 mm – 4 3/4"

Rumel-Belmont

325 mm – 12 3/4"
Tourniquet

3.2 mm Ø
SI-VS-02-10
For children

6.4 mm Ø
SI-VS-02-10A
For adults



Trousse à varices
Varicose vein probe set
Juego para várices
Astuccio per varici



Nabatoff
135 mm x 100 mm x 25 mm
SI-VS-02-11
Complete

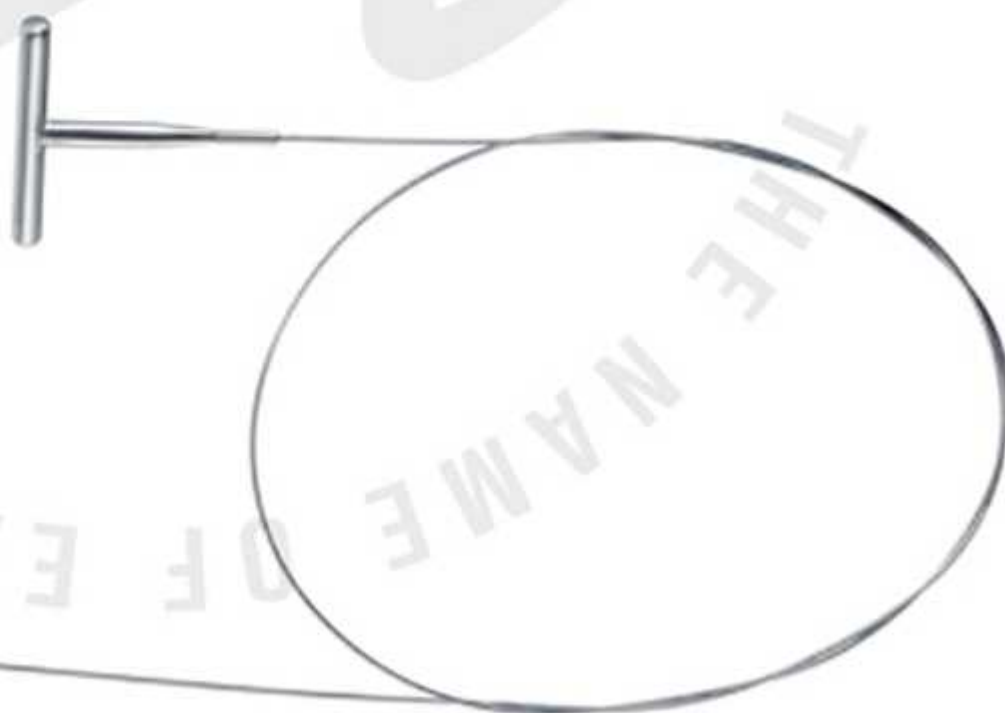

3 mm Ø



6 mm Ø



9 mm Ø



12 mm Ø

Clamps Bulldog
Bulldog clamps
Clamps Bulldog
Pinze Bulldog



Johns Hopkins

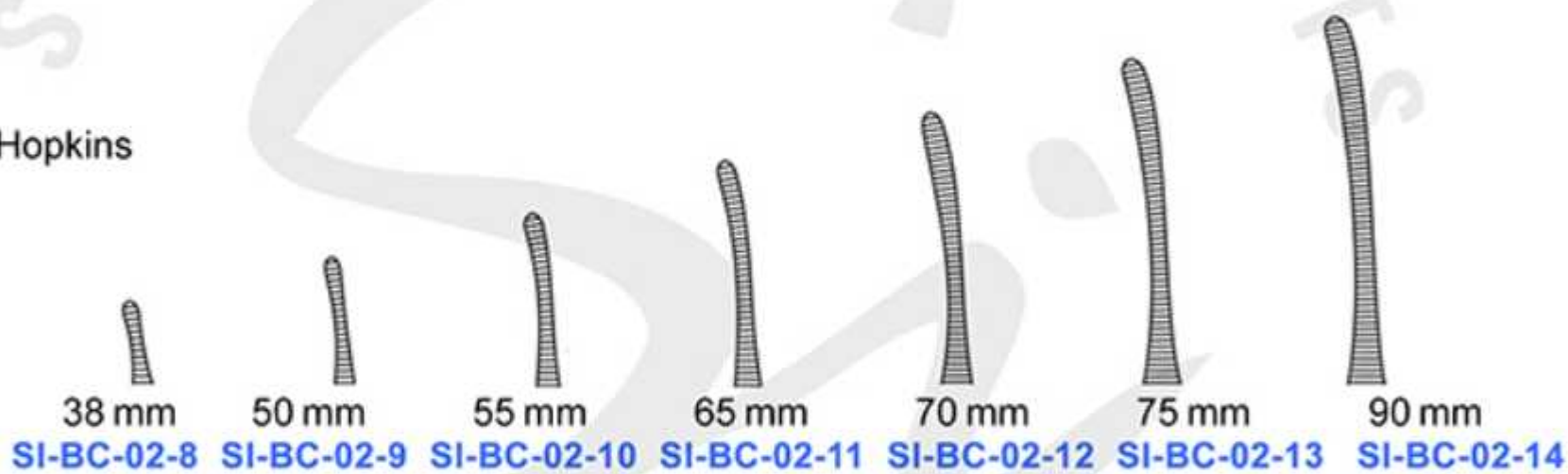
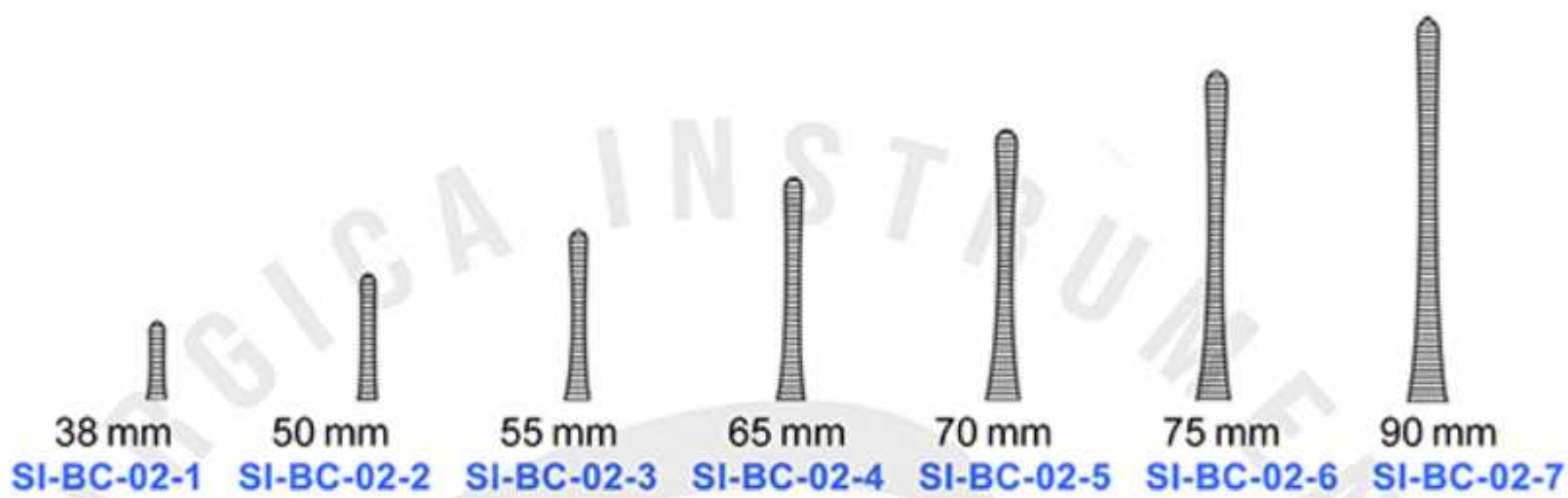

Applying forceps For Bulldog clamps
235 mm – 9 1/4 " **SI-BC-02-15**



Clamps Bulldog
Bulldog clamps
Clamps Bulldog
Pinze Bulldog



Diethrich
50 mm – 2"

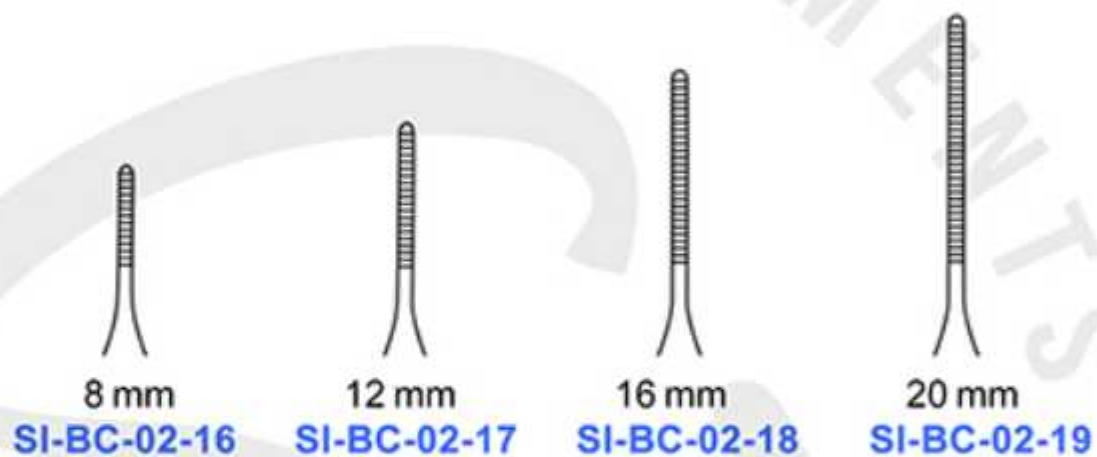

Diethrich
50 mm – 2"

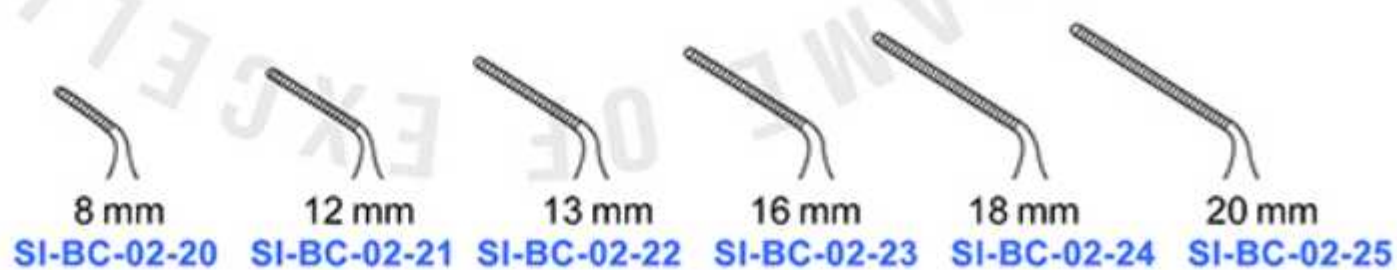

Clamps Bulldog
Bulldog clamps
Clamps Bulldog
Pinze Bulldog



x=
y=
for Veins
for Arteries
for Veins
for Arteries
x= Length

30 mm
11 mm

35 mm
15 mm

40 mm
17 mm

50 mm
24 mm

gms = 110
gms = 220

SI-BC-02-26 SI-BC-02-27 SI-BC-02-28 SI-BC-02-29
SI-BC-02-26A SI-BC-02-27A SI-BC-02-28A SI-BC-02-29A
y= Serated jaw part gms= Closing force

x=
y=
for Veins
for Arteries
for Veins
for Arteries
x= Length

30 mm
11 mm

35 mm
15 mm

40 mm
17 mm

50 mm
24 mm

gms = 110
gms = 220

SI-BC-02-30 SI-BC-02-31 SI-BC-02-32 SI-BC-02-33
SI-BC-02-30A SI-BC-02-31A SI-BC-02-32A SI-BC-02-33A
y= Serated jaw part gms= Closing force

x=
y=
for Veins
for Arteries
for Veins
for Arteries
x= Length

30 mm
11 mm

35 mm
15 mm

40 mm
17 mm

50 mm
24 mm

gms = 110
gms = 220

SI-BC-02-34 SI-BC-02-35 SI-BC-02-36 SI-BC-02-37
SI-BC-02-34A SI-BC-02-35A SI-BC-02-36A SI-BC-02-37A
y= Serated jaw part gms= Closing force

Clamps Bulldog
Bulldog clamps
Clamps Bulldog
Pinze Bulldog



Applying forceps for Mini -Glover bulldog clamps
230 mm – 9" **SI-BC-02-38**



De Bakey -
Diethrich

x=
y=
Code=
gms =
x= Length

49 mm	53 mm	59 mm	44 mm	46 mm	49 mm	
10 mm	14 mm	20 mm	10 mm	14 mm	20 mm	
SI-BC-02-39	SI-BC-02-40	SI-BC-02-41	SI-BC-02-42	SI-BC-02-43	SI-BC-02-44	
180						
	y= Serated jaw part	gms=Closing force				

Clamps Bulldog
Bulldog clamps
Clamps Bulldog
Pinze Bulldog



Cooley

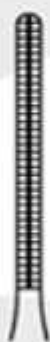

80 mm

SI-BC-02-45

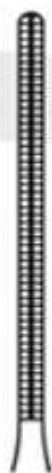

90 mm

SI-BC-02-46



105 mm

SI-BC-02-47



125 mm

SI-BC-02-48



75 mm

SI-BC-02-49



85 mm

SI-BC-02-50



95 mm

SI-BC-02-51



115 mm

SI-BC-02-52

Clamps Bulldog
Bulldog clamps
Clamps Bulldog
Pinze Bulldog



De Bakey

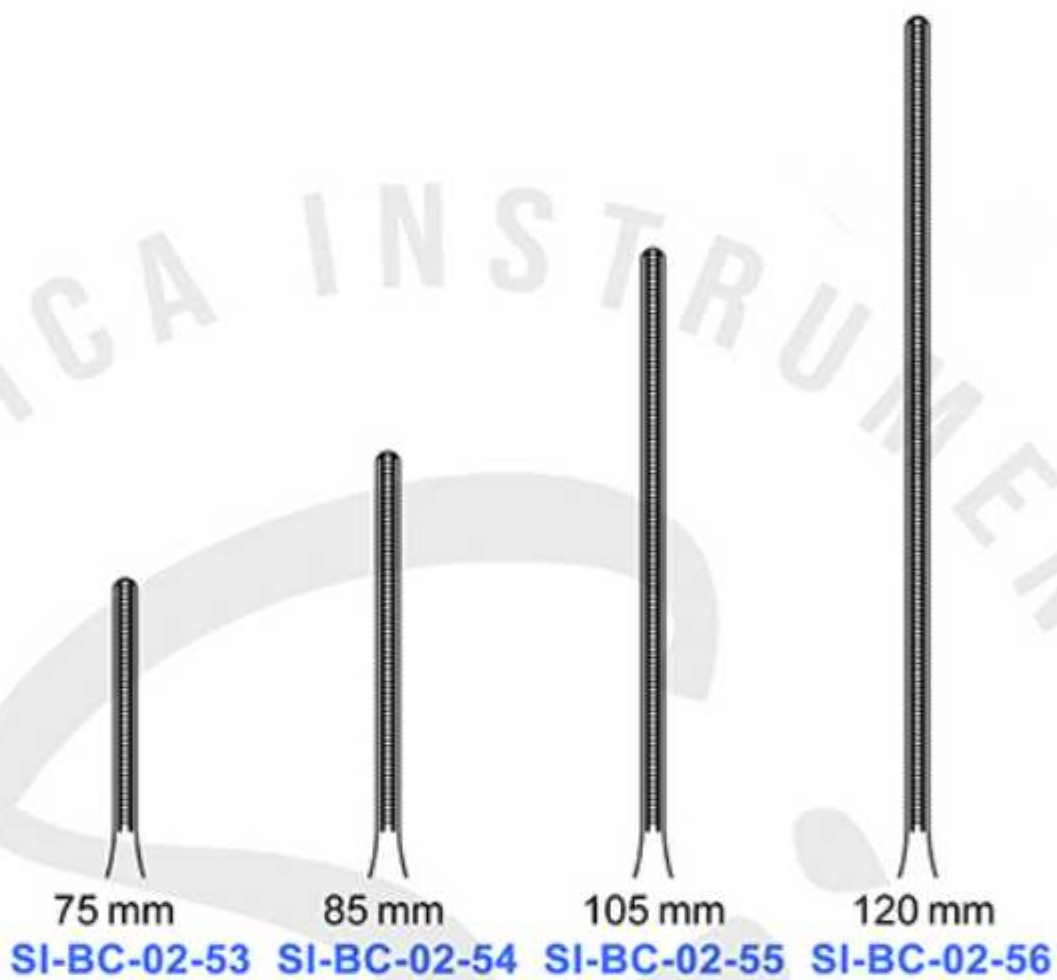

De Bakey

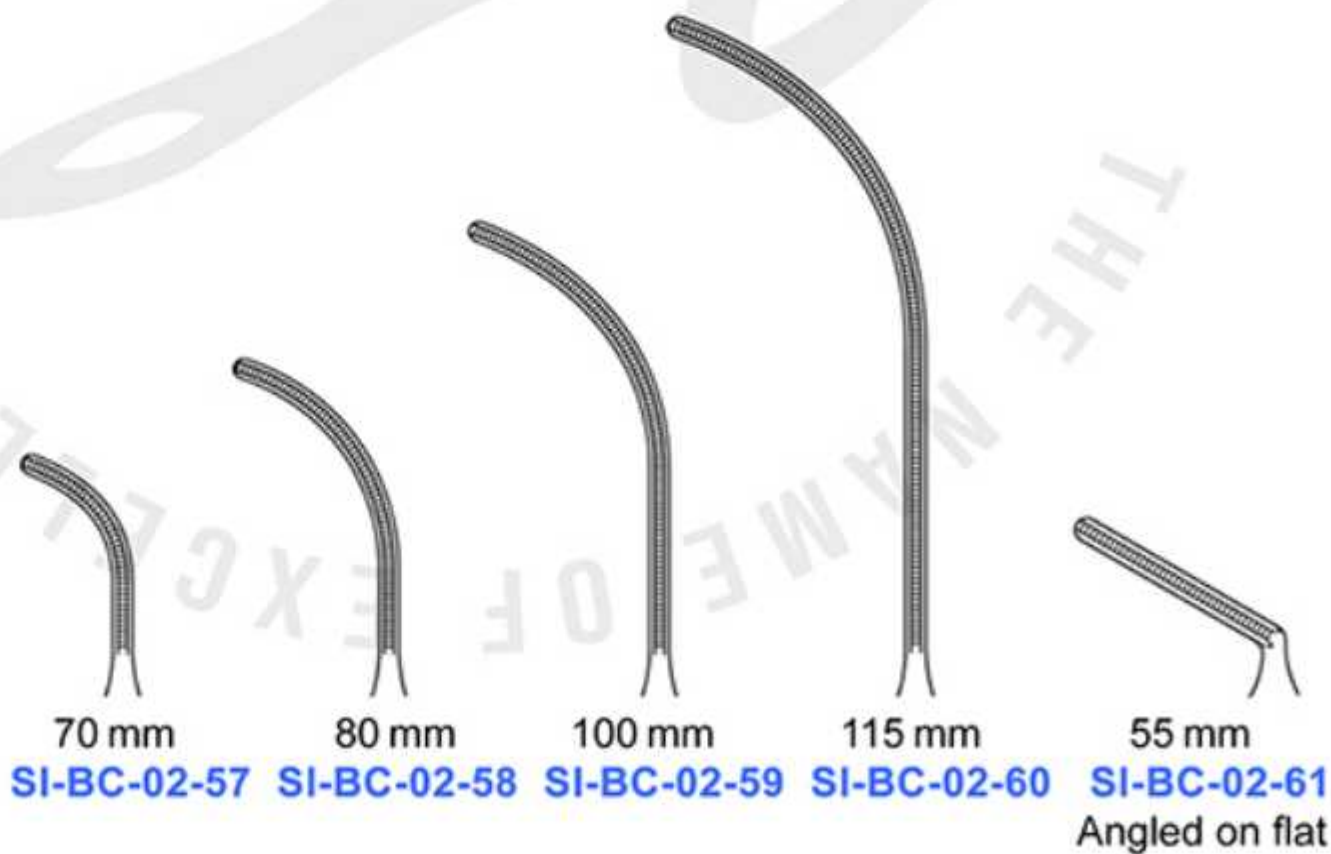

Clamps Bulldog
Bulldog clamps
Clamps Bulldog
Pinze Bulldog



Glover



Glover

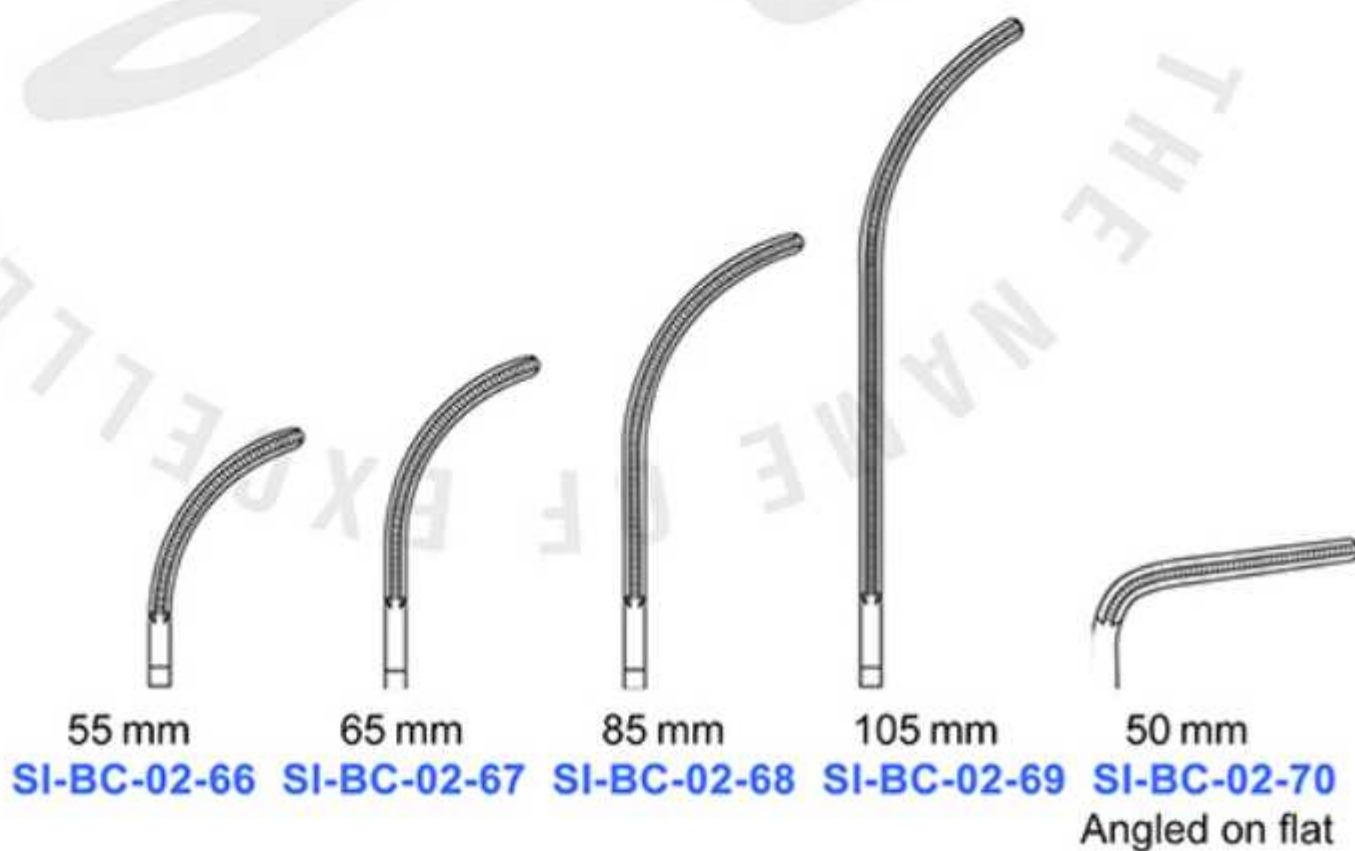

Clamps Bulldog
Bulldog clamps
Clamps Bulldog
Pinze Bulldog



De Bakey-Satinsky
70 mm – 2 3/4 "
SI-BC-02-71



De Bakey-Carotis
90 mm – 3 1/2 "
SI-BC-02-72



De Bakey-Satinsky
100 mm – 4 "
SI-BC-02-73

Clamps Bulldog
Bulldog clamps
Clamps Bulldog
Pinze Bulldog



Santulli
70 mm – 2 3/4 "
SI-BC-02-74



Gregory-soft
90 mm – 3 1/2 "
SI-BC-02-75



Gregory-soft
110 mm – 4 1/4 "
SI-BC-02-76

Pinces vasculaires
Vascular forceps
Pinzas vasculares
Pinze vascolari



De Bakey-Mosquito



Straight
125 mm

SI-VF-02-01



Curved
125 mm

SI-VF-02-02



De Bakey-Rankin



Straight
160 mm

SI-VF-02-03



Curved
160 mm

SI-VF-02-04

Pinces vasculaires
Vascular forceps
Pinzas vasculares
Pinze vascolari



De Bakey-Pean

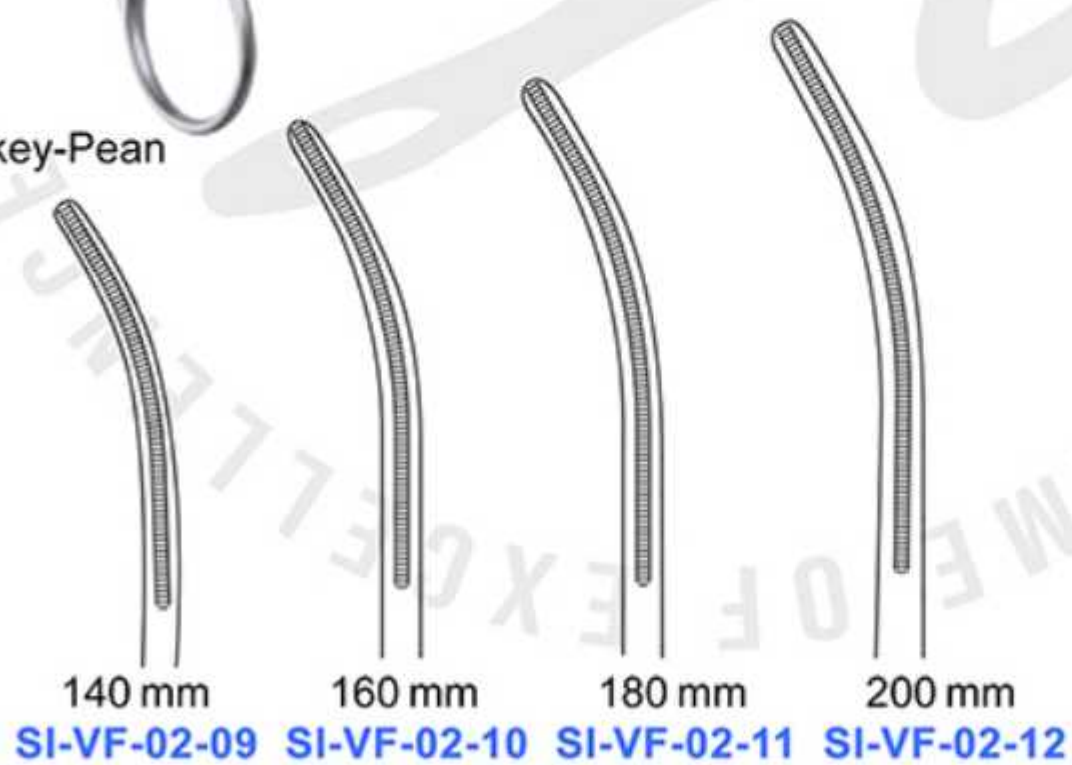
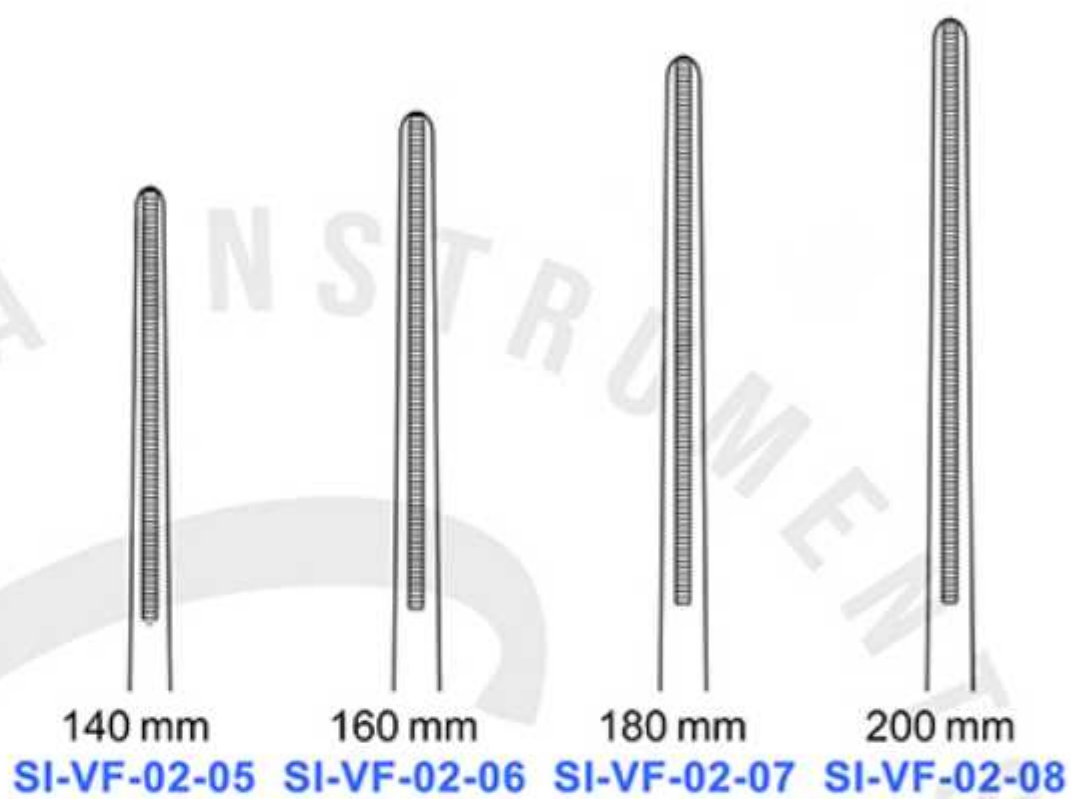

De Bakey-Pean

Pinces vasculaires
Vascular forceps
Pinzas vasculares
Pinze vascolari



Potts

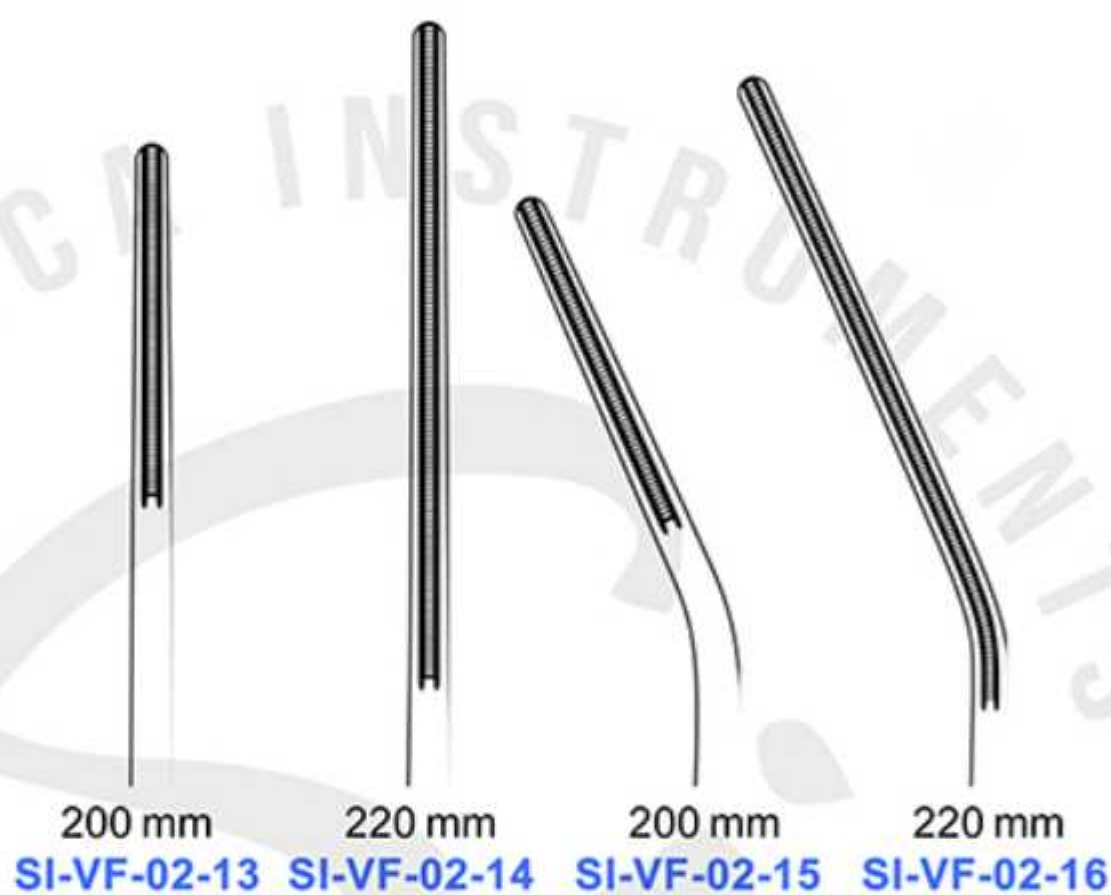

Potts

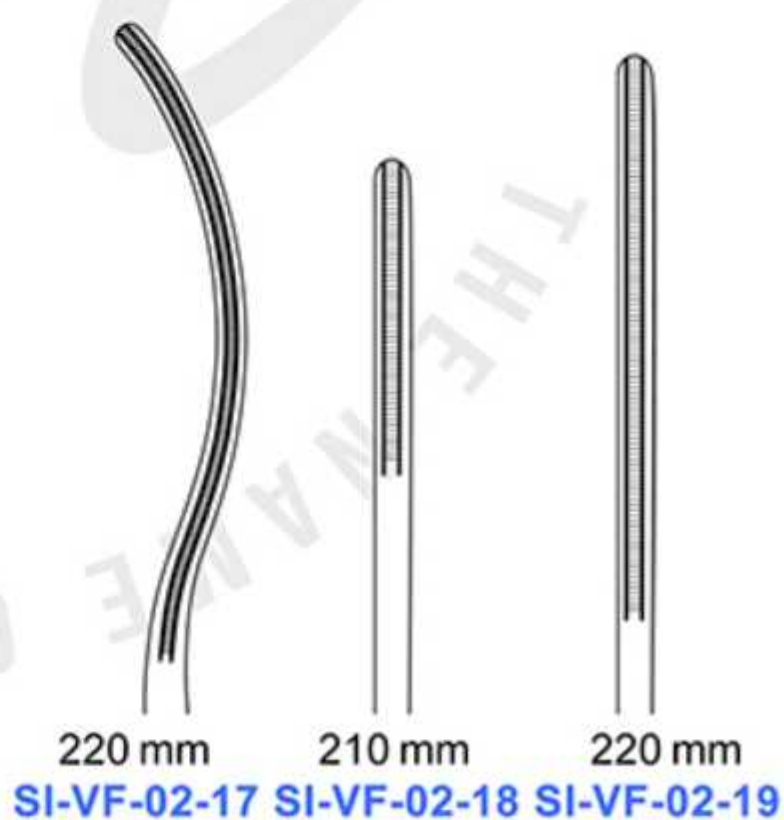

Pinces vasculaires
Vascular forceps
Pinzas vasculares
Pinze vascolari

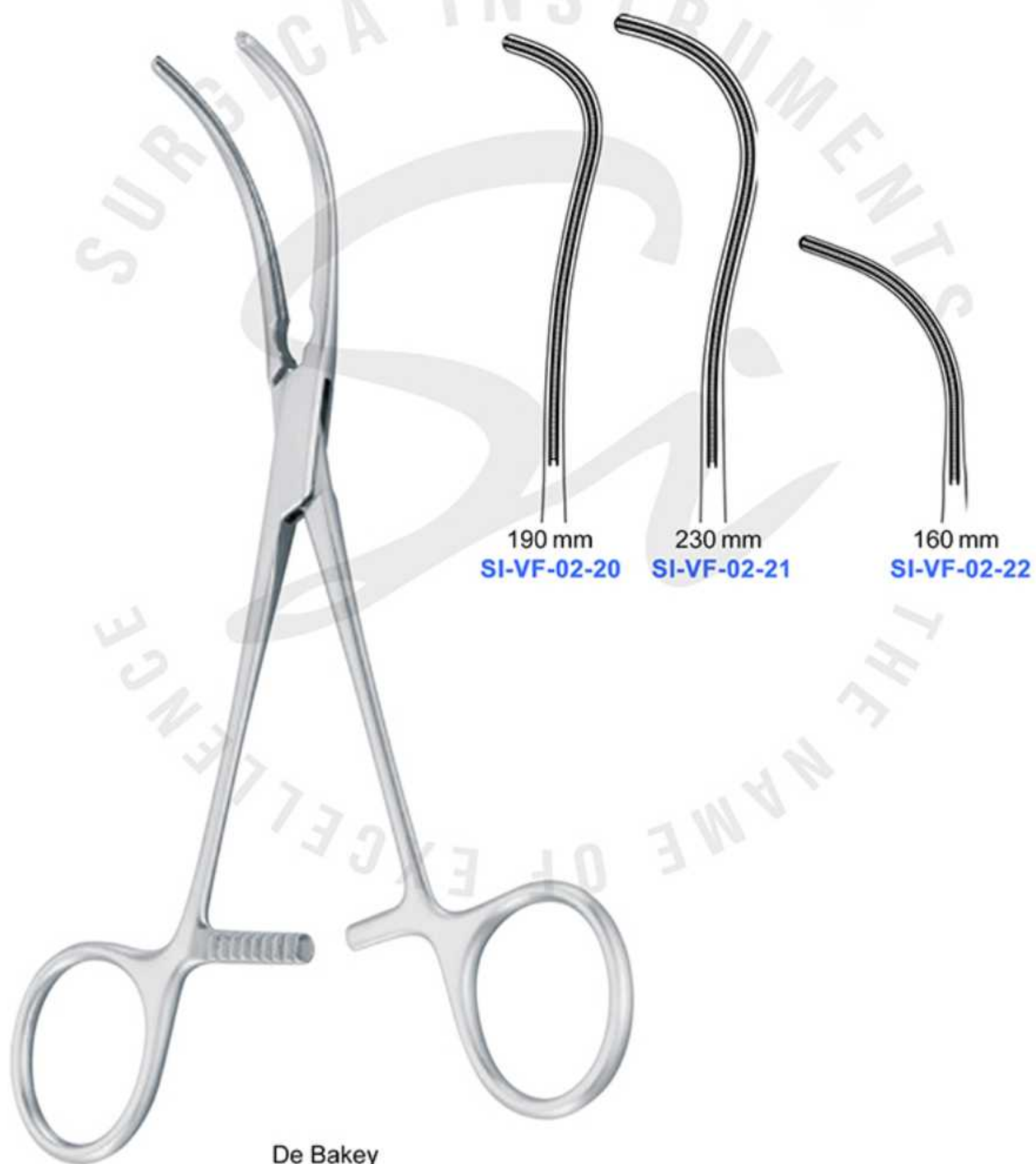

Pinces vasculaires
Vascular forceps
Pinzas vasculares
Pinze vascolari



Leland-Jones

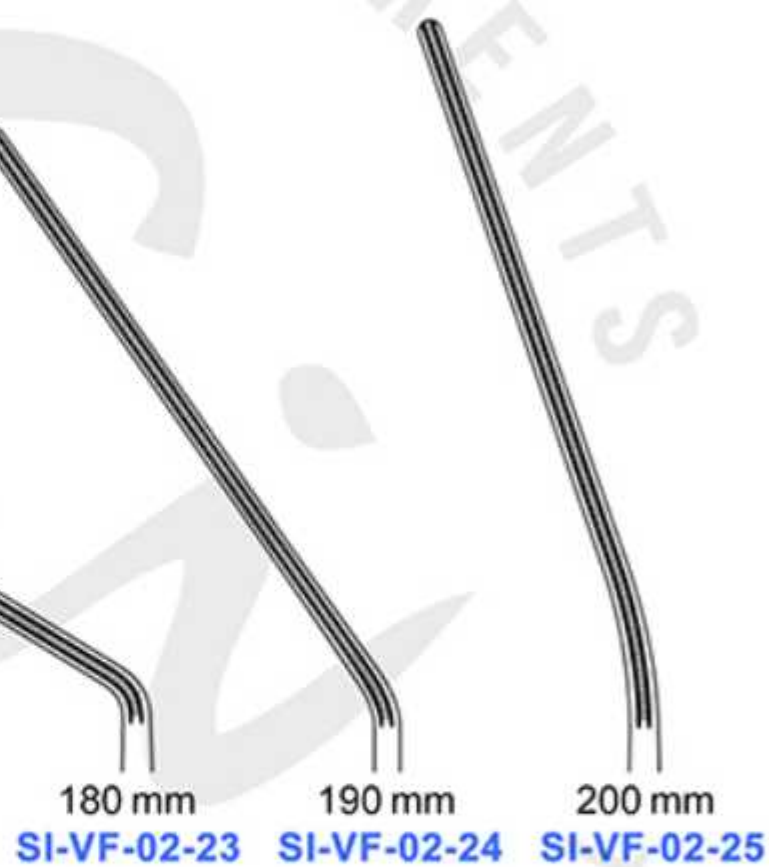

Pinces vasculaires
Vascular forceps
Pinzas vasculares
Pinze vascolari

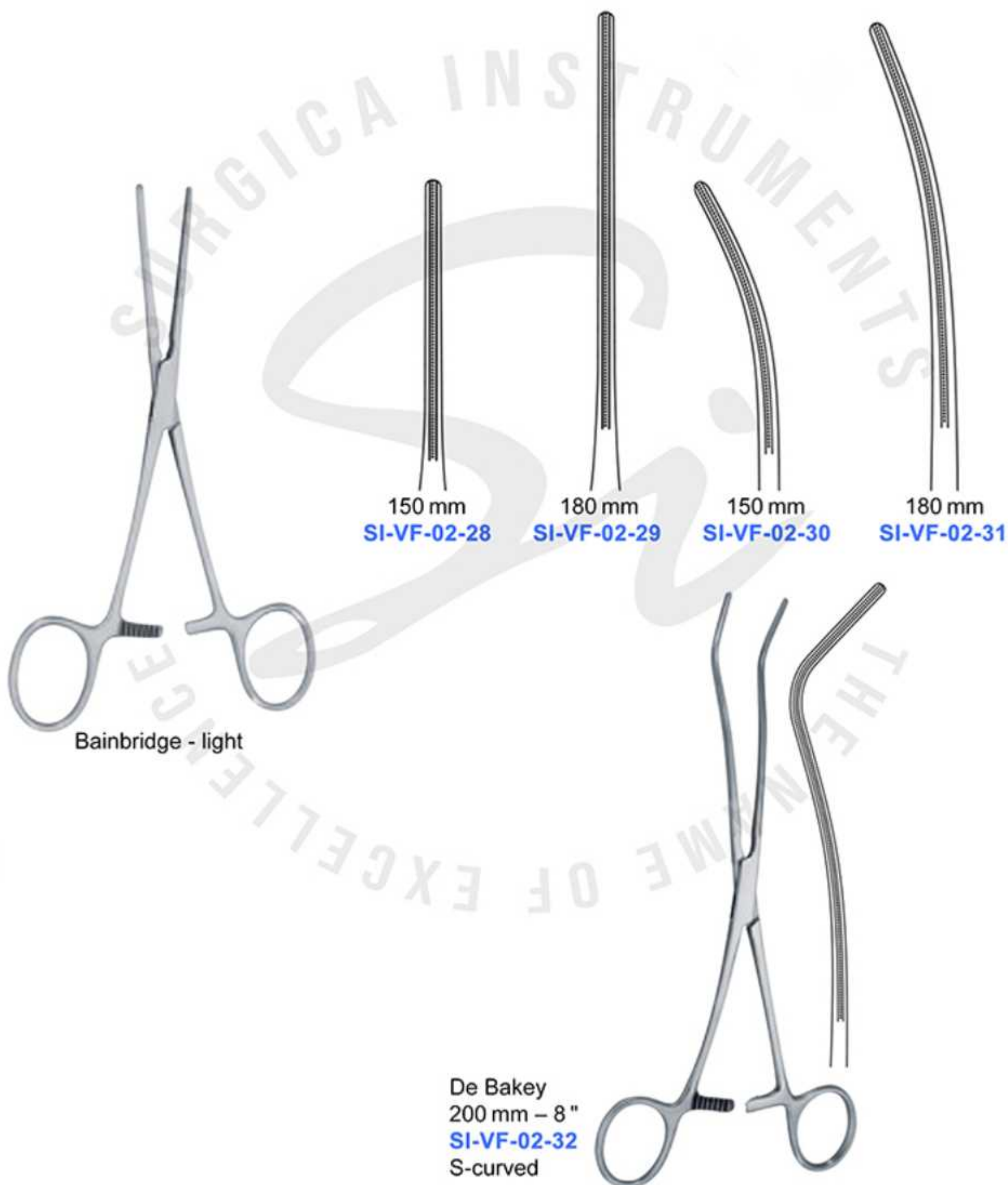

Bainbridge - light

150 mm
SI-VF-02-28

180 mm
SI-VF-02-29

150 mm
SI-VF-02-30

180 mm
SI-VF-02-31

De Bakey
200 mm – 8"
SI-VF-02-32
S-curved

Pinces vasculaires
Vascular forceps
Pinzas vasculares
Pinze vascolari

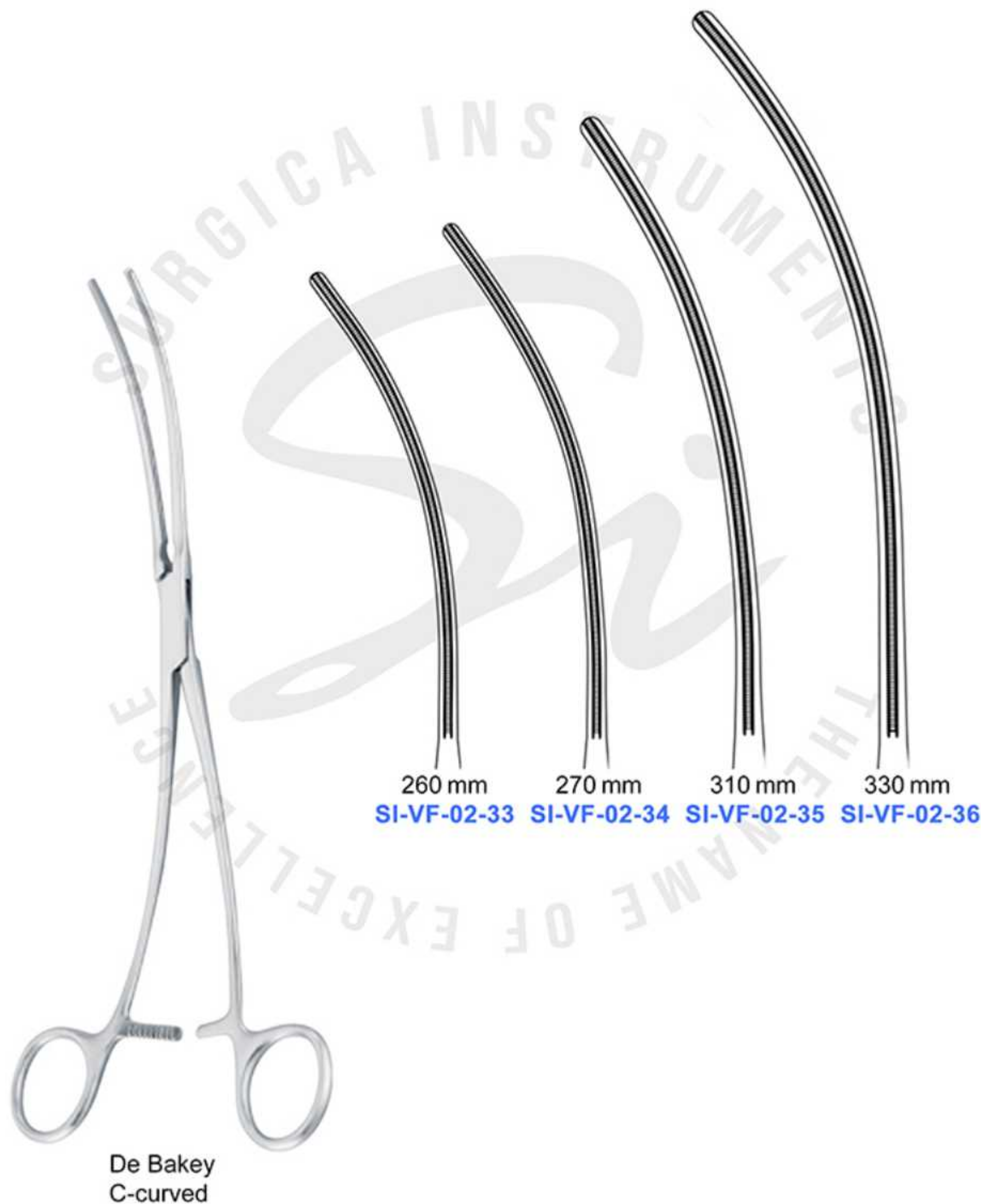

Pinces vasculaires
Vascular forceps
Pinzas vasculares
Pinze vascolari



De Bakey

280 mm – 11 "
SI-VF-02-37

300 mm – 11 3/4 "
SI-VF-02-38
S-curved

Pinces vasculaires
Vascular forceps
Pinzas vasculares
Pinze vascolari



Weber

260 mm – 10 1/4 "
SI-VF-02-39
Curved left

260 mm – 10 1/4 "
SI-VF-02-40
Curved right

VASCULAR SURGERY

Pinces vasculaires
Vascular forceps
Pinzas vasculares
Pinze vascolari



Morris-De Bakey

180 mm – 7 "
SI-VF-02-41

200 mm – 8 "
SI-VF-02-42

230 mm – 9 "
SI-VF-02-43

250 mm – 9 3/4 "
SI-VF-02-44

Pinces vasculaires
Vascular forceps
Pinzas vasculares
Pinze vascolari

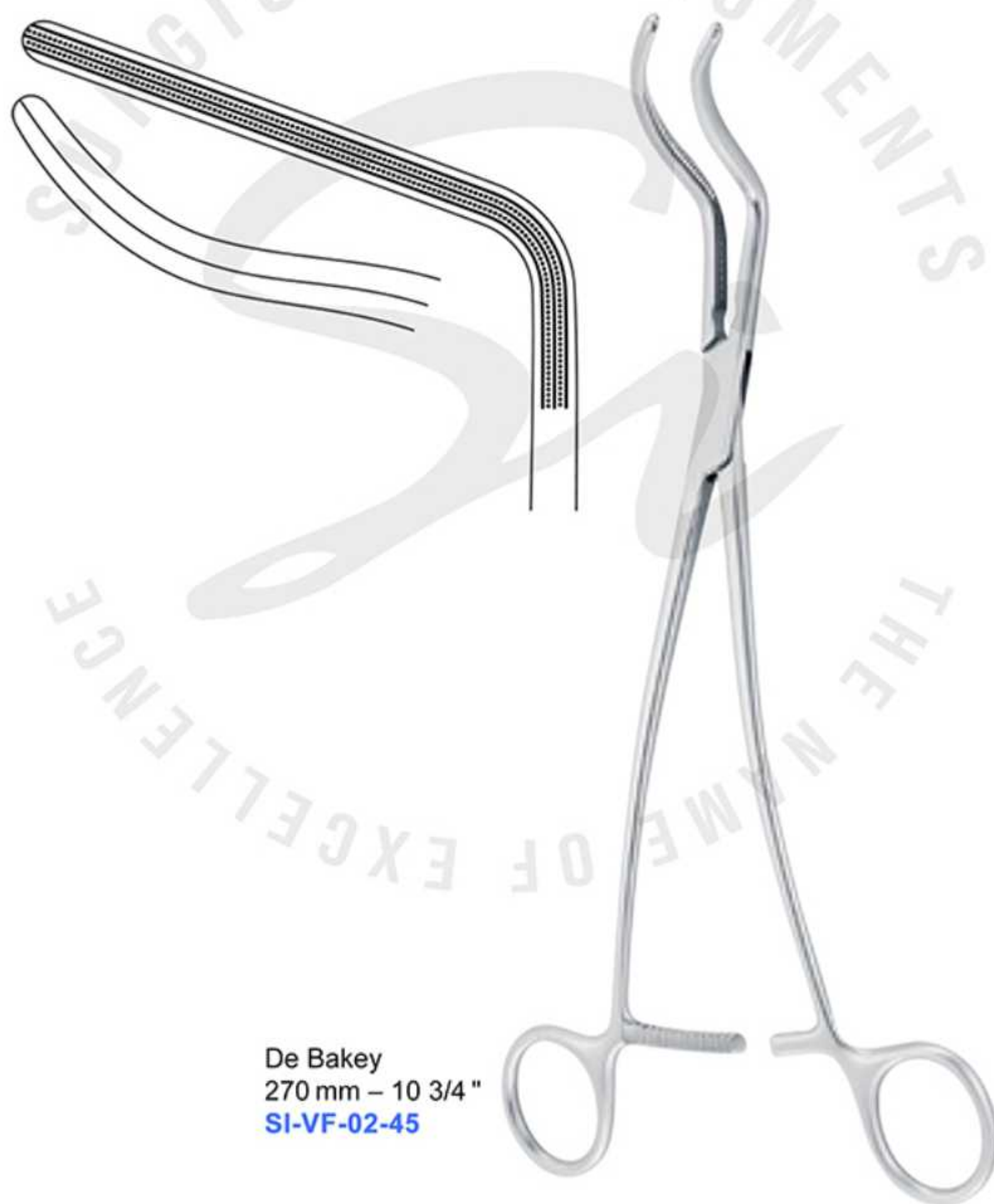

De Bakey
270 mm – 10 3/4"
SI-VF-02-45

Pinces vasculaires
Vascular forceps
Pinzas vasculares
Pinze vascolari



De Bakey-Bahnson

Pinces vasculaires
Vascular forceps
Pinzas vasculares
Pinze vascolari

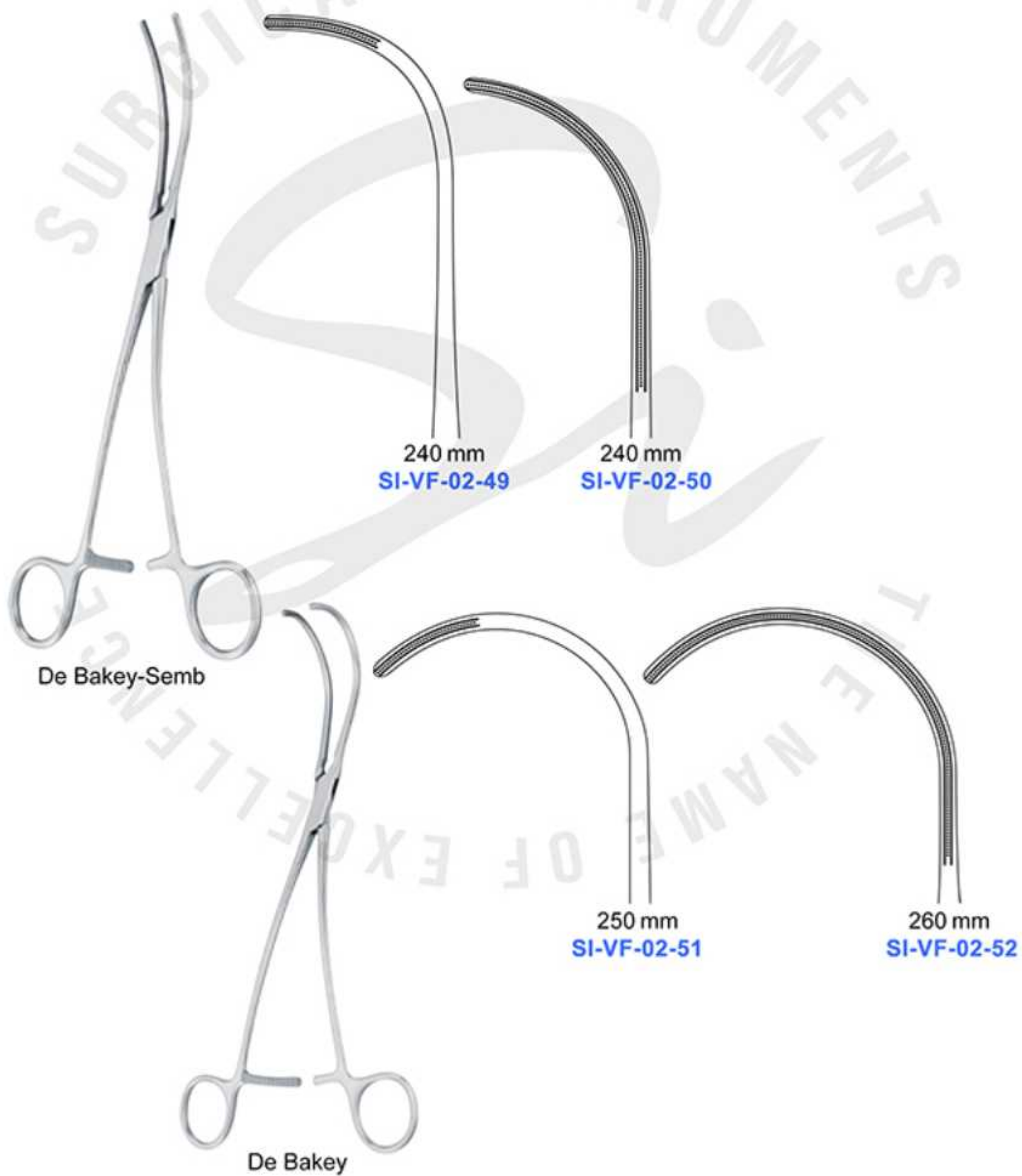

Pinces vasculaires
Vascular forceps
Pinzas vasculares
Pinze vascolari



Satinsky-De Bakey



205 mm
SI-VF-02-53

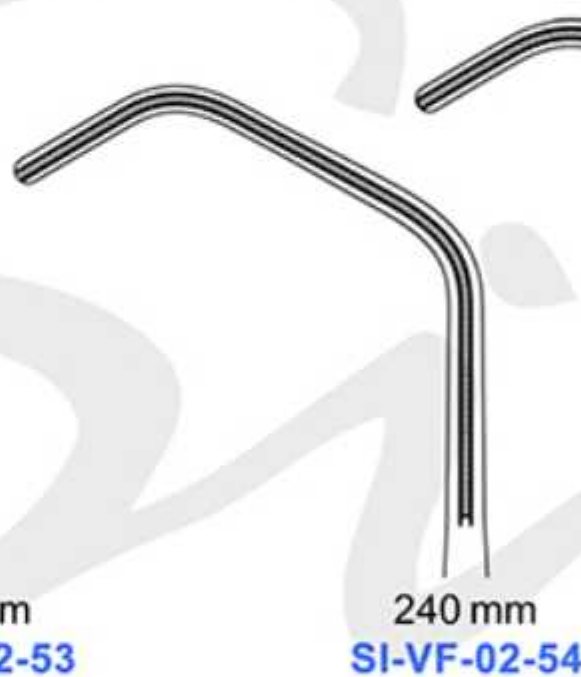

240 mm
SI-VF-02-54



250 mm
SI-VF-02-55

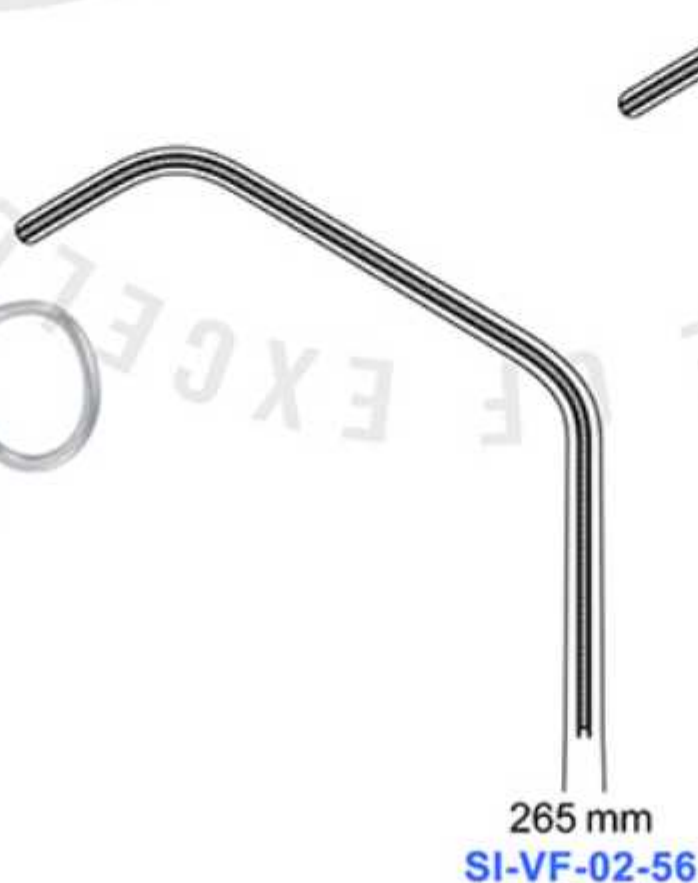

265 mm
SI-VF-02-56



275 mm
SI-VF-02-57

Pinces vasculaires
Vascular forceps
Pinzas vasculares
Pinze vascolari



Pinces vasculaires
Vascular forceps
Pinzas vasculares
Pinze vascolari



Lambert-Kay

200 mm
SI-VF-02-61

200 mm
SI-VF-02-62

Pinces vasculaires
Vascular forceps
Pinzas vasculares
Pinze vascolari



De Bakey

215 mm

SI-VF-02-63

230 mm

SI-VF-02-64

270 mm

SI-VF-02-65

315 mm

SI-VF-02-66



215 mm

SI-VF-02-63



230 mm

SI-VF-02-64



270 mm

SI-VF-02-65



315 mm

SI-VF-02-66

Pinces vasculaires
Vascular forceps
Pinzas vasculares
Pinze vascolari



De Bakey

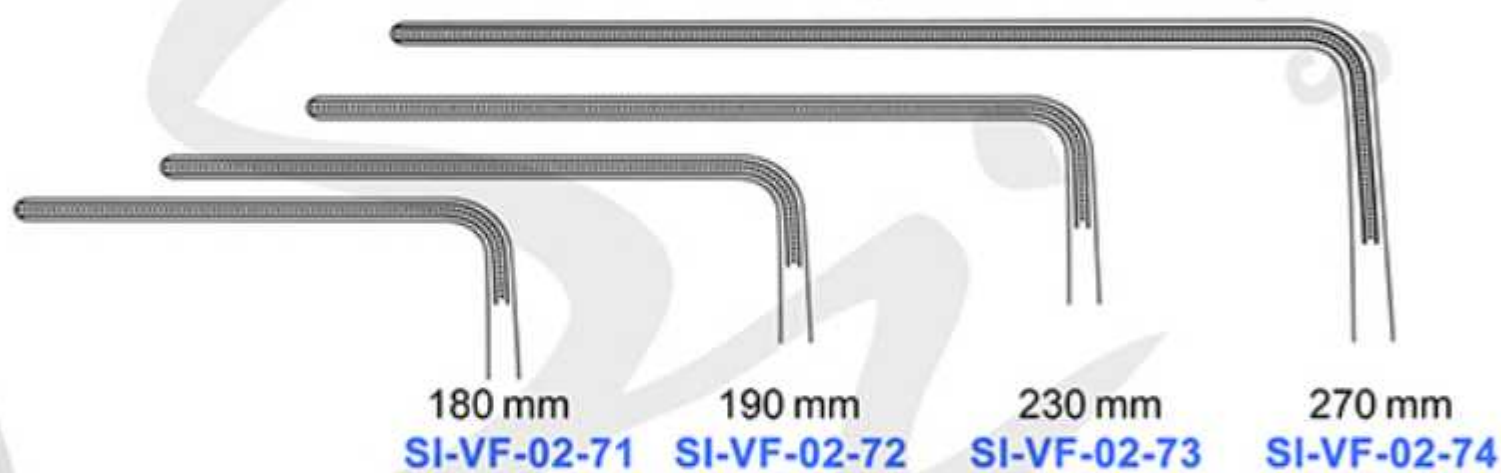

180 mm

SI-VF-02-71

190 mm

SI-VF-02-72

230 mm

SI-VF-02-73

270 mm

SI-VF-02-74

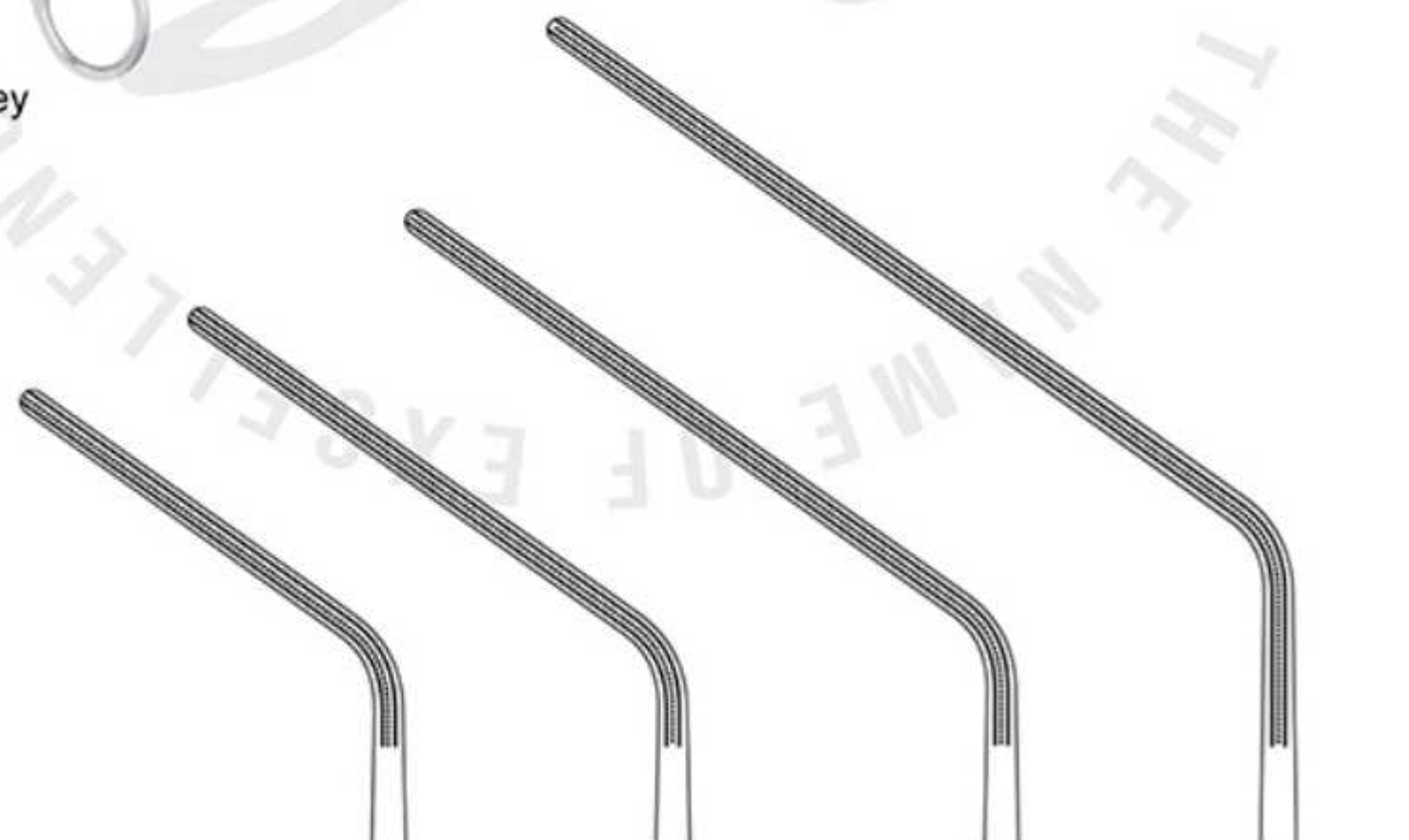

200 mm

SI-VF-02-75

210 mm

SI-VF-02-76

250 mm

SI-VF-02-77

300 mm

SI-VF-02-78

Pinces vasculaires
Vascular forceps
Pinzas vasculares
Pinze vascolari



Dardik

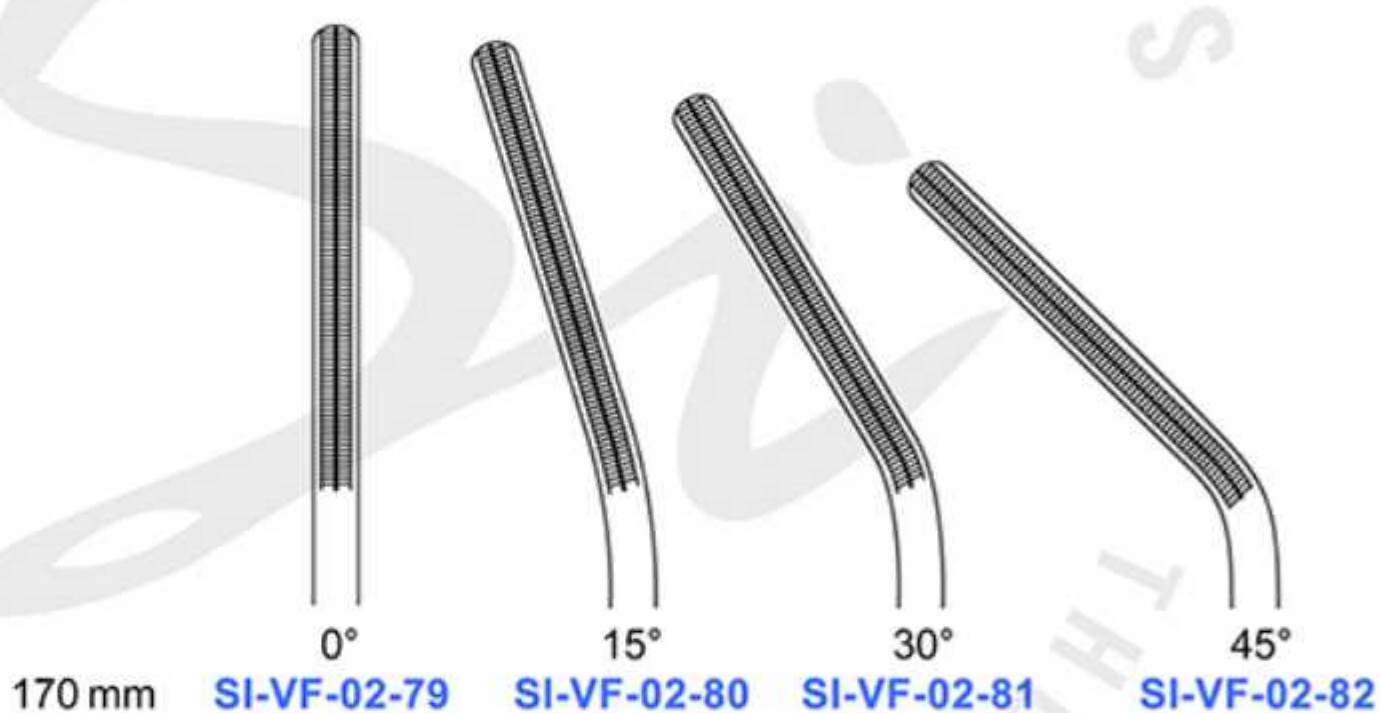

170 mm

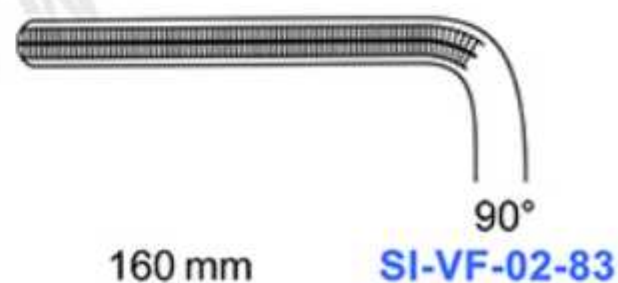

160 mm

SI-VF-02-83

Pinces vasculaires
Vascular forceps
Pinzas vasculares
Pinze vascolari



Ochsner
235 mm – 9 1/4 "
SI-VF-02-84



Diethrich
210 mm – 8 1/4 "
SI-VF-02-85

Pinces vasculaires
Vascular forceps
Pinzas vasculares
Pinze vascolari

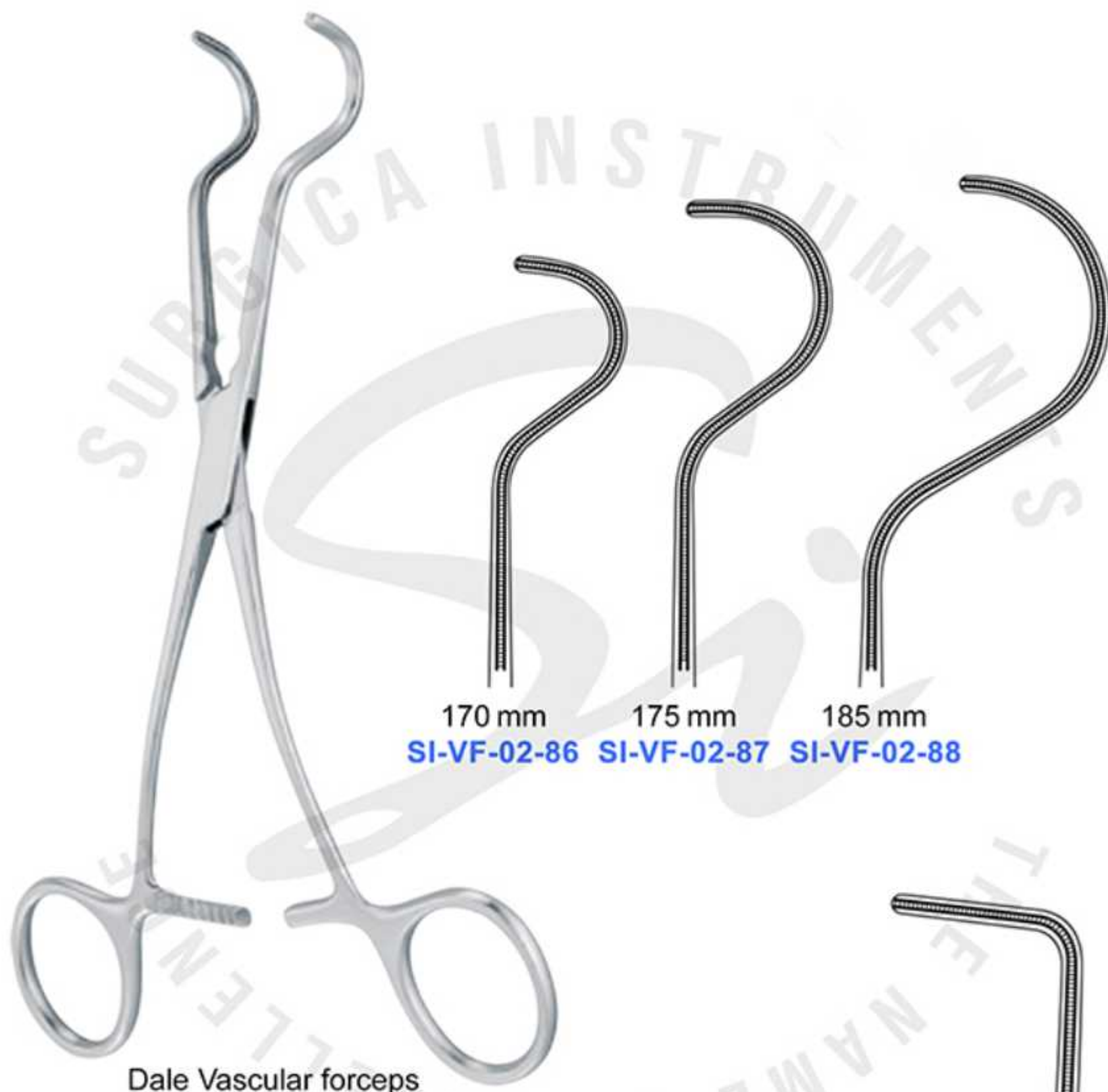

Dale Vascular forceps

170 mm
SI-VF-02-86

175 mm
SI-VF-02-87

185 mm
SI-VF-02-88

185 mm
SI-VF-02-89

Pinces vasculaires
Vascular forceps
Pinzas vasculares
Pinze vascolari

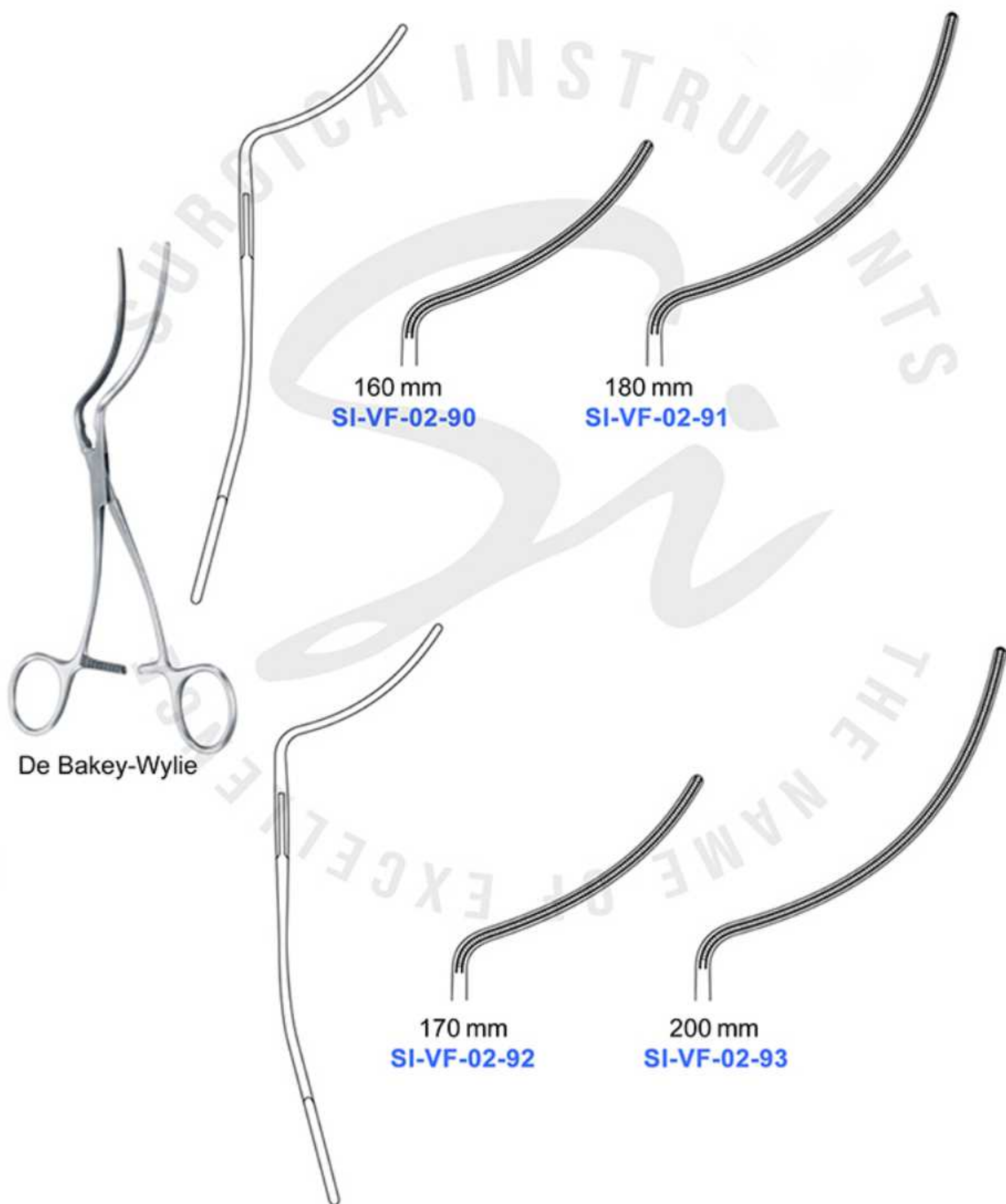

Pinces vasculaires
Vascular forceps
Pinzas vasculares
Pinze vascolari

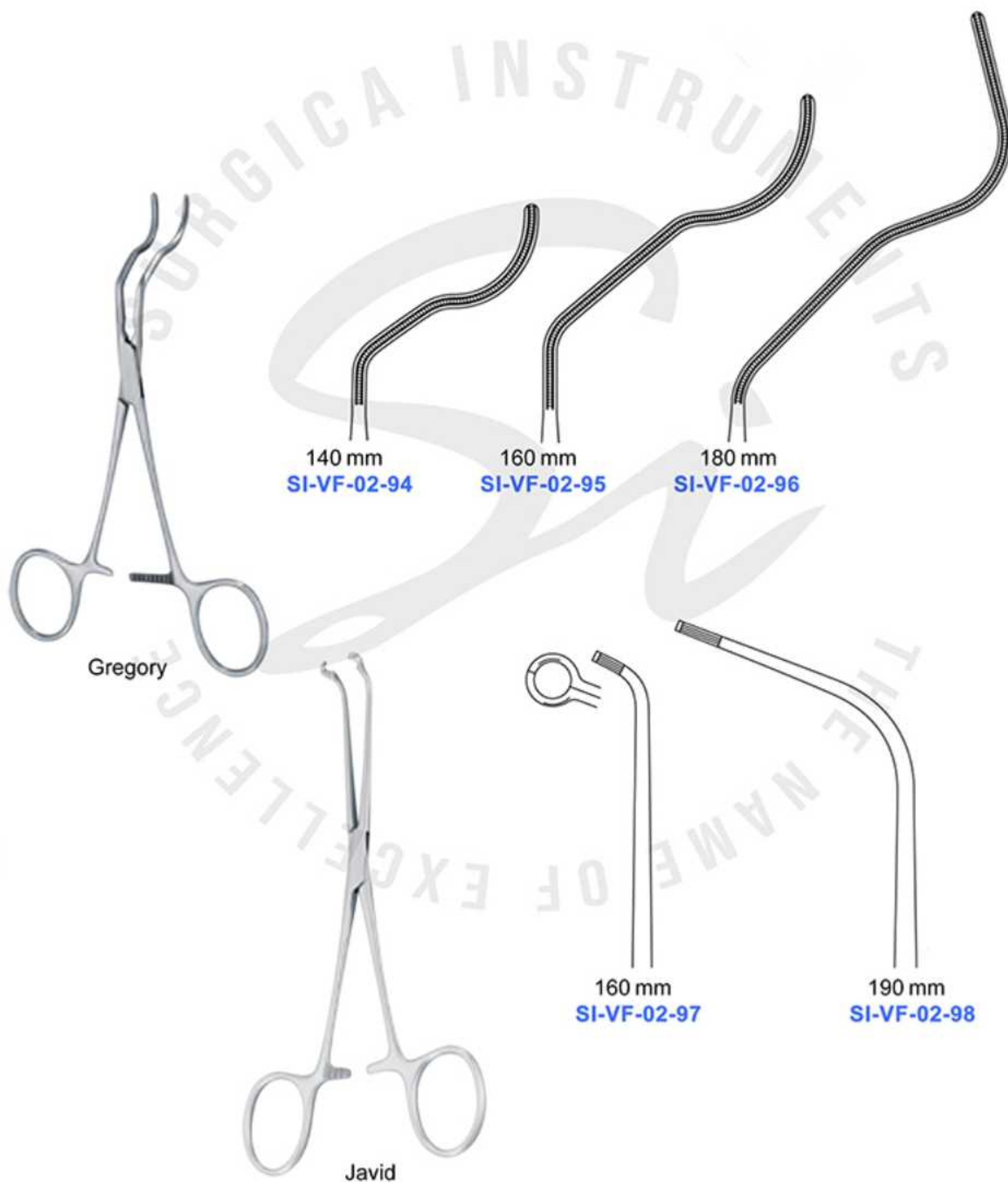

Pinces vasculaires
Vascular forceps
Pinzas vasculares
Pinze vascolari

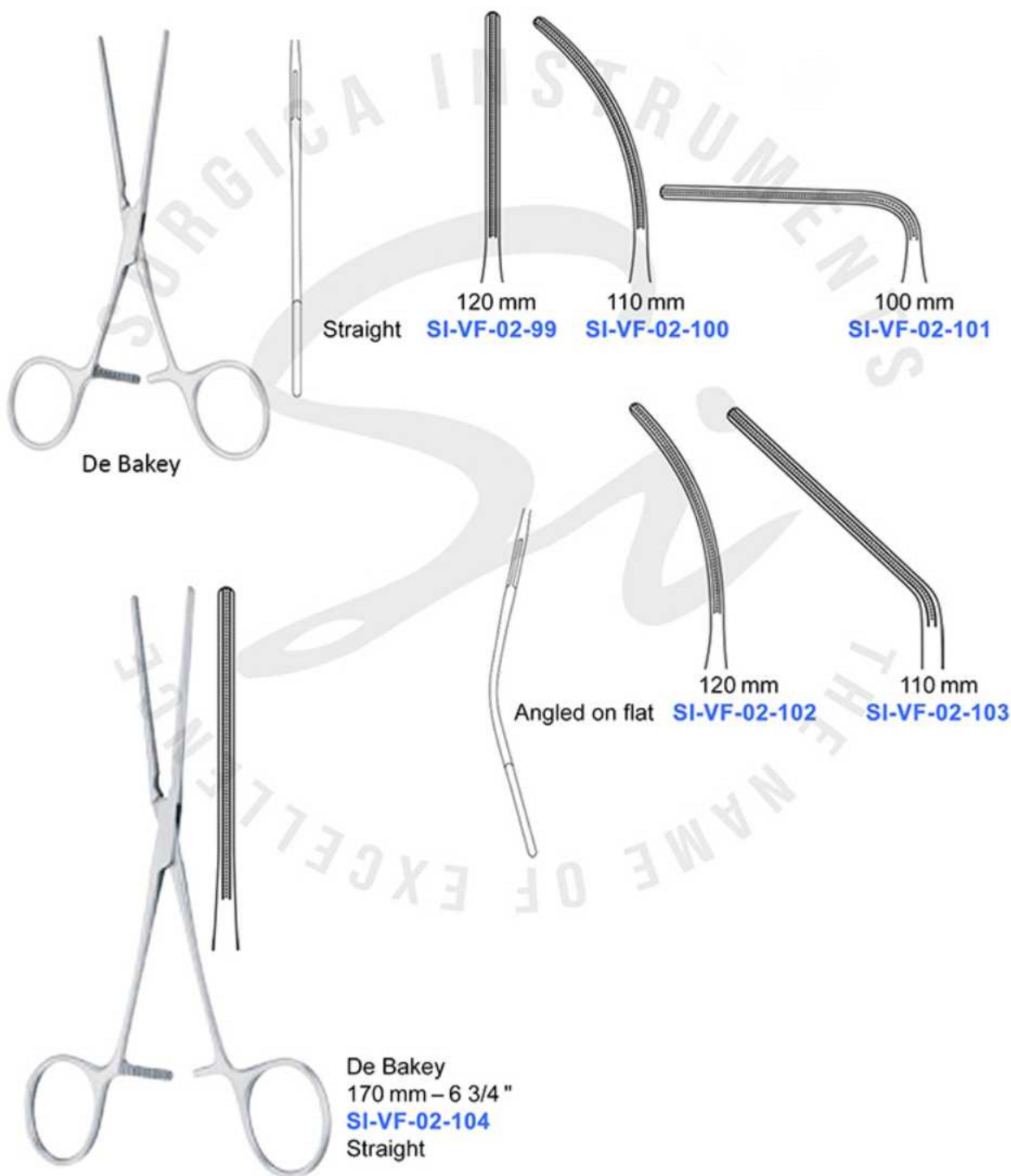

Pinces vasculaires
Vascular forceps
Pinzas vasculares
Pinze vascolari

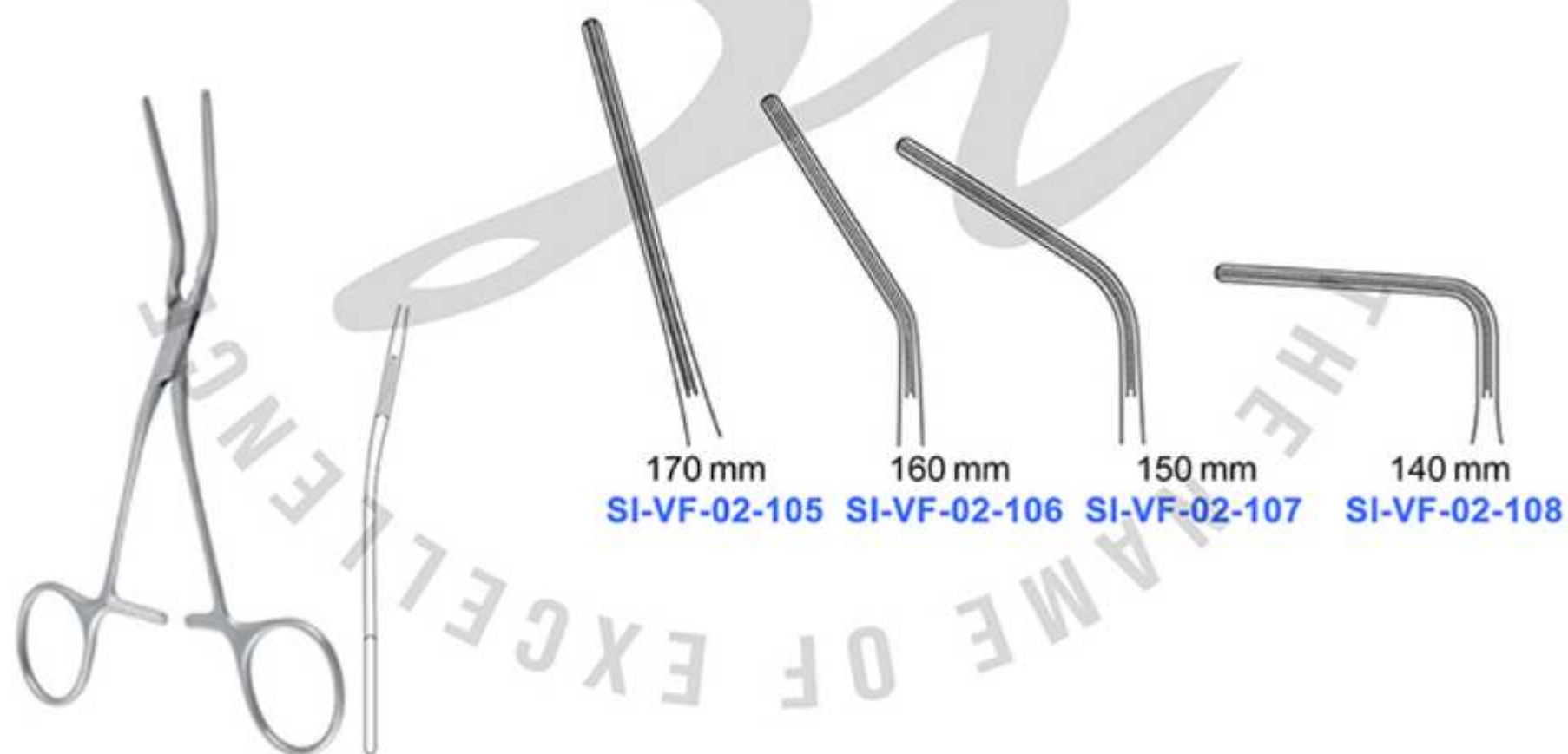

De Bakey
Angled on flat

170 mm SI-VF-02-105
160 mm SI-VF-02-106
150 mm SI-VF-02-107
140 mm SI-VF-02-108

Pinces vasculaires
Vascular forceps
Pinzas vasculares
Pinze vascolari



Glover



205 mm
SI-VF-02-109



220 mm
SI-VF-02-110



260 mm
SI-VF-02-111



205 mm
SI-VF-02-112
Angled on flat



220 mm
SI-VF-02-113
Angled on flat



260 mm
SI-VF-02-114
Angled on flat

Pinces vasculaires
Vascular forceps
Pinzas vasculares
Pinze vascolari



Glover

170 mm
SI-VF-02-115

210 mm
SI-VF-02-116

240 mm
SI-VF-02-117

185 mm
SI-VF-02-118

220 mm
SI-VF-02-119

Pinces vasculaires
Vascular forceps
Pinzas vasculares
Pinze vascolari

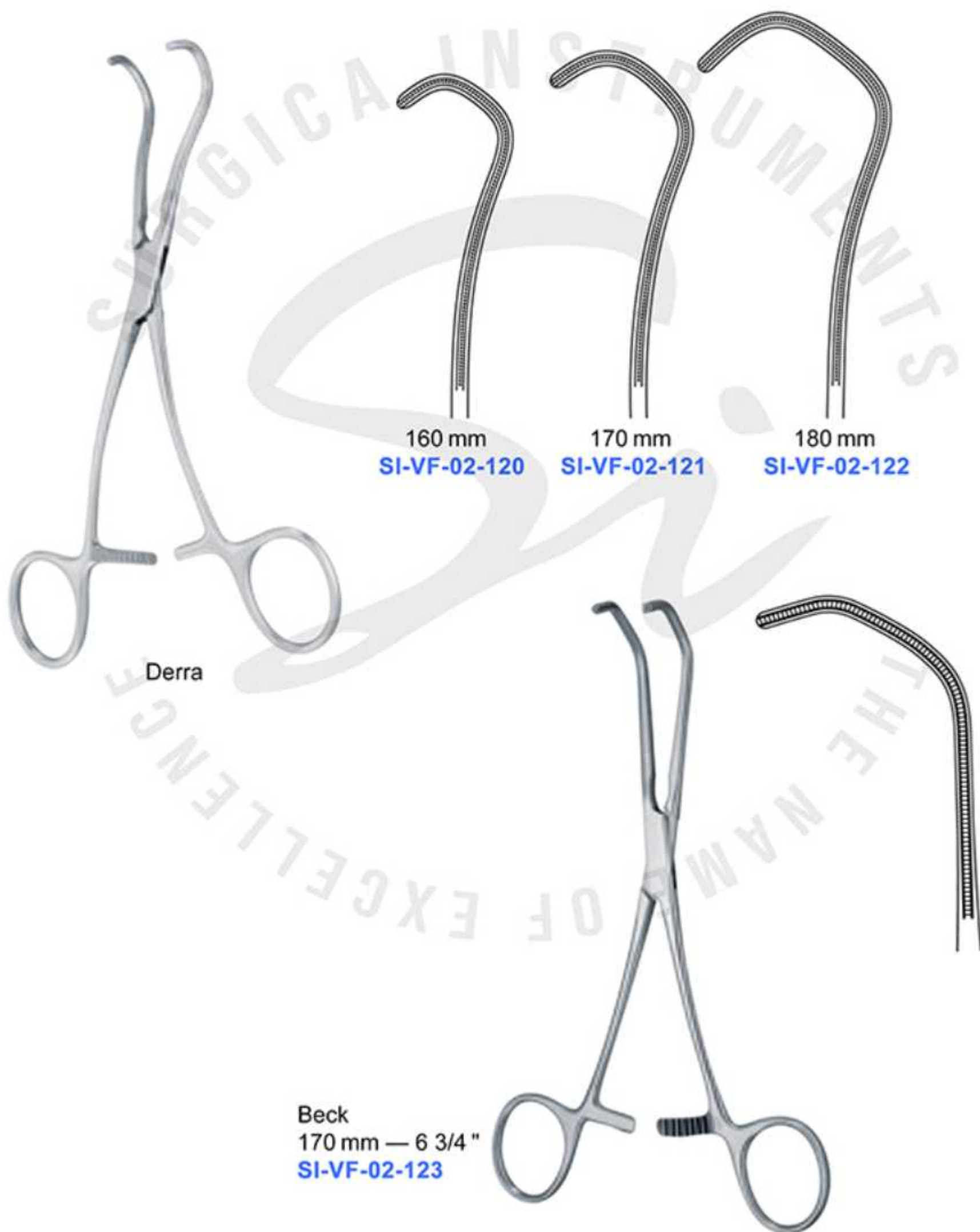

Pinces vasculaires
Vascular forceps
Pinzas vasculares
Pinze vascolari



120 mm

SI-VF-02-124
Straight

SI-VF-02-125
Curved

SI-VF-02-126
S-Curved

120 mm

SI-VF-02-127
Sideways angled

SI-VF-02-128
Angled on flat

SI-VF-02-129
90° angled on flat

Pinces vasculaires
Vascular forceps
Pinzas vasculares
Pinze vascolari

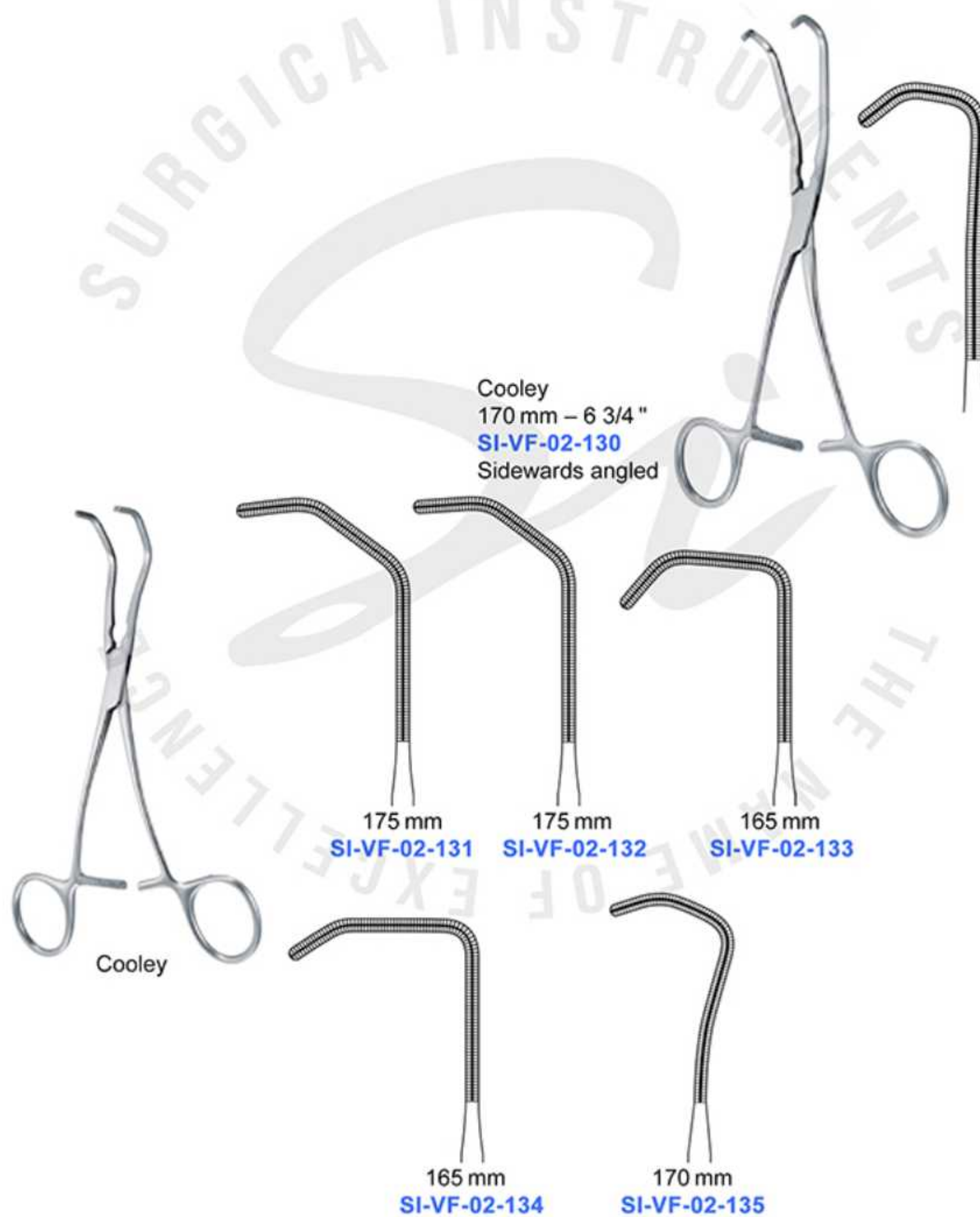

Pinces vasculaires
Vascular forceps
Pinzas vasculares
Pinze vascolari



Cooley-Derra



165 mm
SI-VF-02-136



170 mm
SI-VF-02-137



175 mm
SI-VF-02-138



Cooley-Beck



150 mm
SI-VF-02-139



155 mm
SI-VF-02-140

Pinces vasculaires
Vascular forceps
Pinzas vasculares
Pinze vascolari



Pinces vasculaires
Vascular forceps
Pinzas vasculares
Pinze vascolari



Cooley

210 mm
SI-VF-02-143
Sidewards
angled on flat

250 mm
SI-VF-02-144
Sidewards
angled on flat



Cooley

180 mm
SI-VF-02-145
Straight

185 mm
SI-VF-02-146
Angled on flat

Pinces vasculaires
Vascular forceps
Pinzas vasculares
Pinze vascolari



Cooley-Tangential



195 mm
SI-VF-02-147

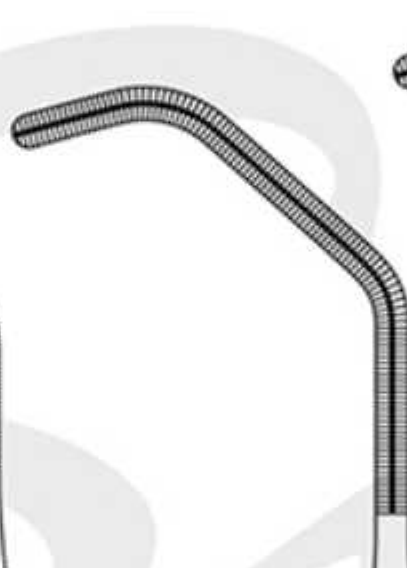

255 mm
SI-VF-02-148



260 mm
SI-VF-02-149



265 mm
SI-VF-02-150

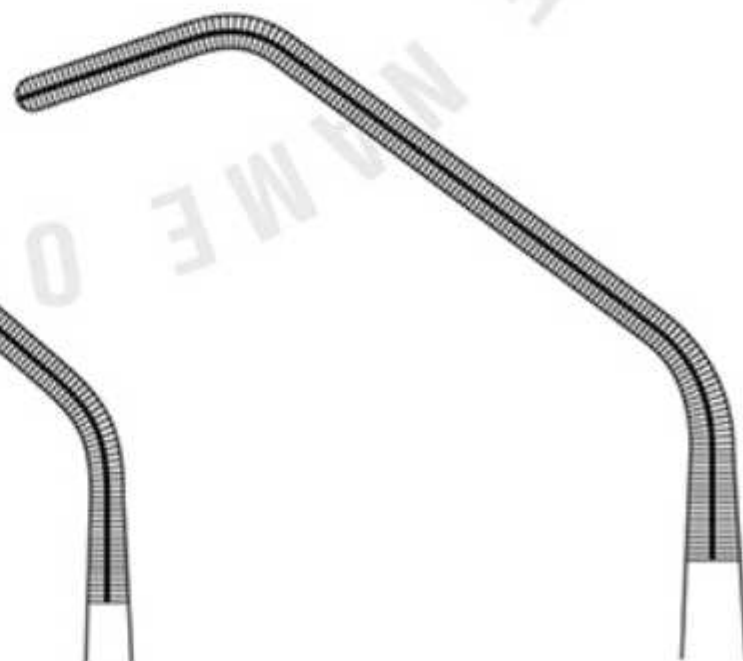

270 mm
SI-VF-02-151

Pinces polyvalentes, pédiatriques, graduées
Multi-purpose clamps, pediatric, graduated
Pinzas de uso vario, pediátricas, graduadas
Pinze multi uso, per bambini, graduati



Cooley



165 mm
25°

SI-MP-02-01

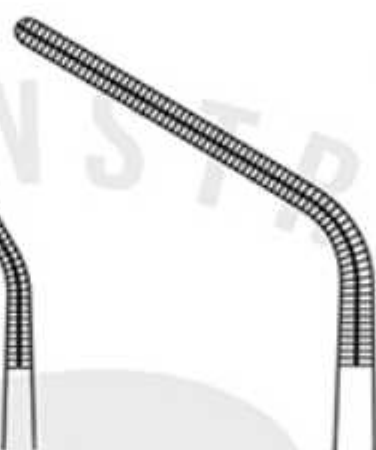

160 mm
45°

SI-MP-02-02



145 mm
90°

SI-MP-02-03



Cooley
160 mm
170 mm
200 mm
210 mm
230 mm

SI-MP-02-04
SI-MP-02-04A
SI-MP-02-04B
SI-MP-02-04C
SI-MP-02-04D

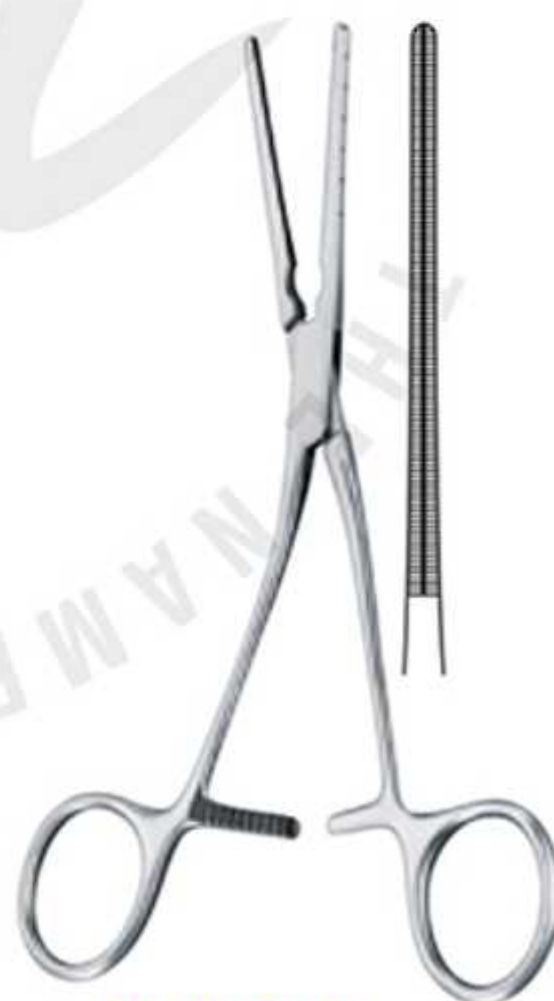

SI-MP-02-05
SI-MP-02-05A
SI-MP-02-05B
SI-MP-02-05C
SI-MP-02-05D
Angled on flat, graduated

Pinces polyvalentes, pédiatriques, graduées
Multi-purpose clamps, pediatric, graduated
Pinzas de uso vario, pediátricas, graduadas
Pinze multi uso, per bambini, graduati



Cooley



200 mm
SI-MP-02-06



195 mm
SI-MP-02-07



Cooley

- x = 24 Charr.
- x = 26 Charr.
- x = 28 Charr.
- x = 30 Charr.
- x = 32 Charr.
- x = 36 Charr.

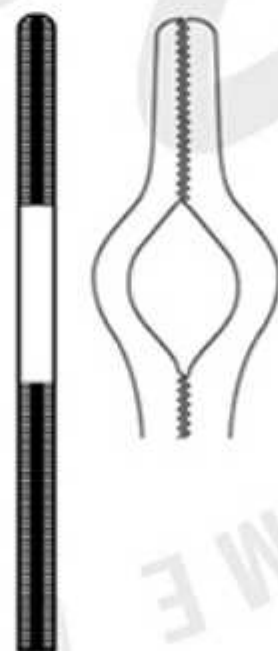

160 mm
SI-MP-02-08
SI-MP-02-08A

200 mm

- SI-MP-02-08B
- SI-MP-02-08C
- SI-MP-02-08D
- SI-MP-02-08E

Pinces polyvalentes, pédiatriques, graduées
Multi-purpose clamps, pediatric, graduated
Pinzas de uso vario, pediátricas, graduadas
Pinze multi uso, per bambini, graduati

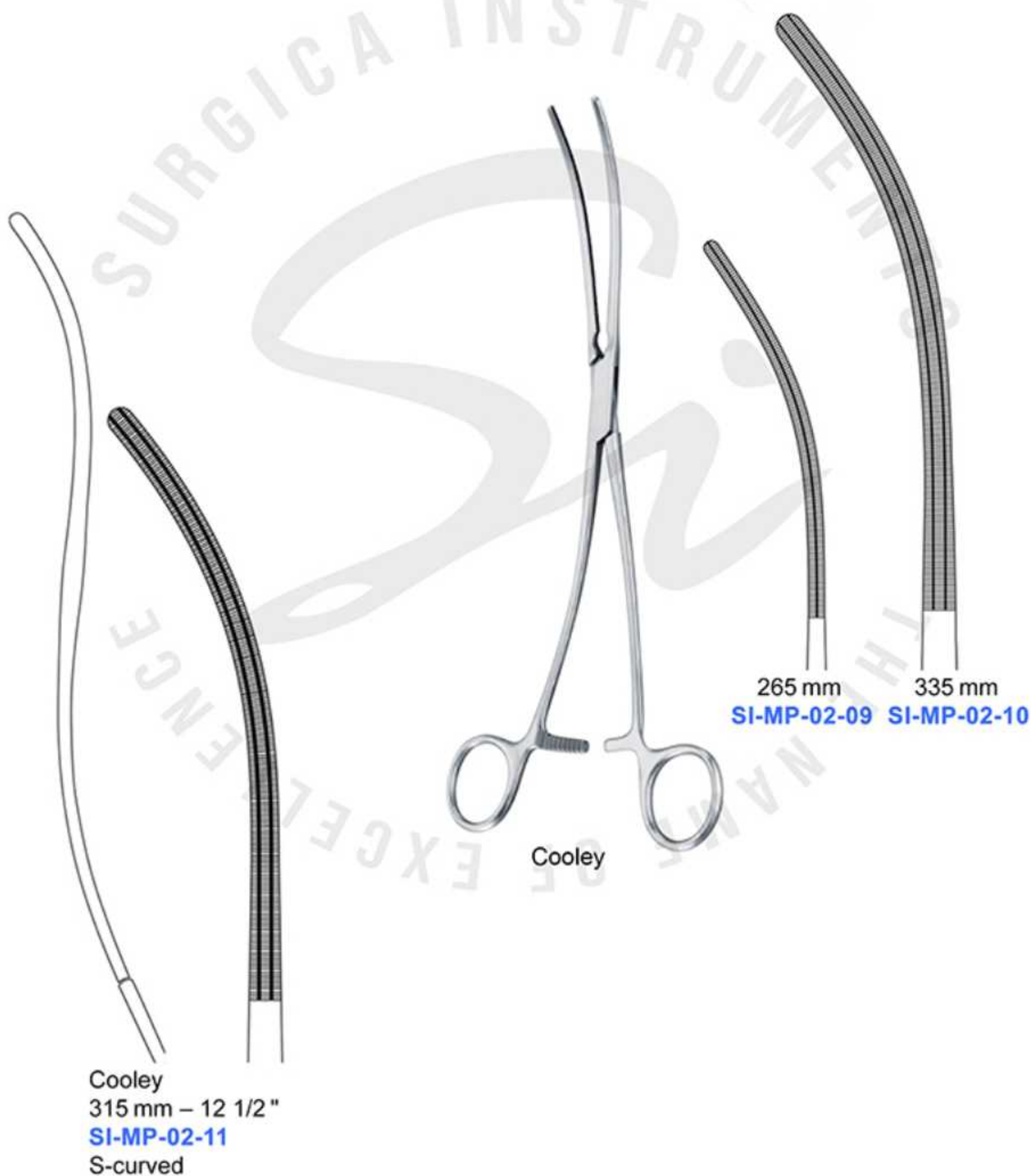

Dilatateurs vasculaires
Vascular dilators
Dilatadores vasculares
Dilatatori vascolari

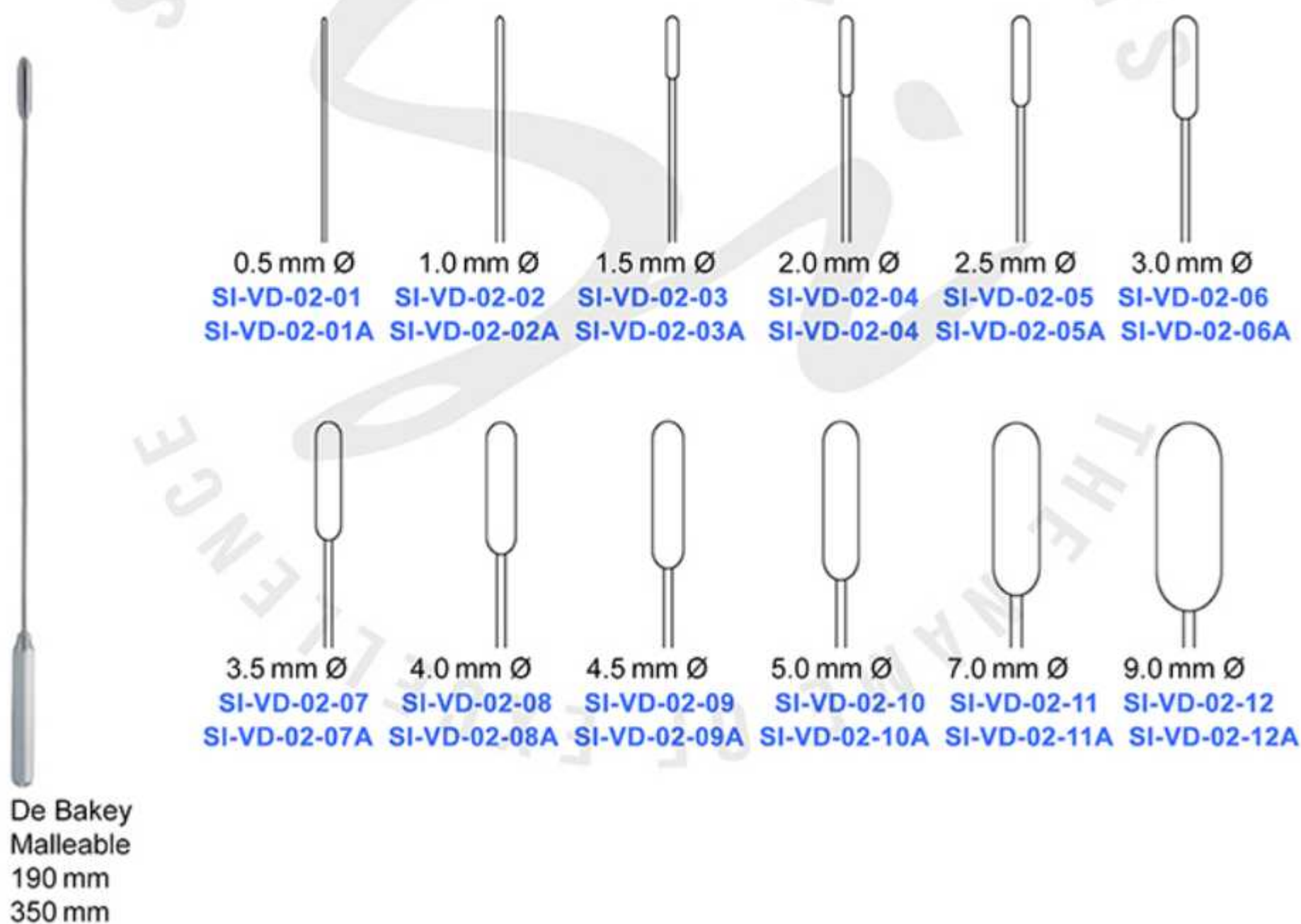

Dilatateurs vasculaires
Vascular dilators
Dilatadores vasculares
Dilatatori vascolari



Cooley
130 mm – 5"
Malleable

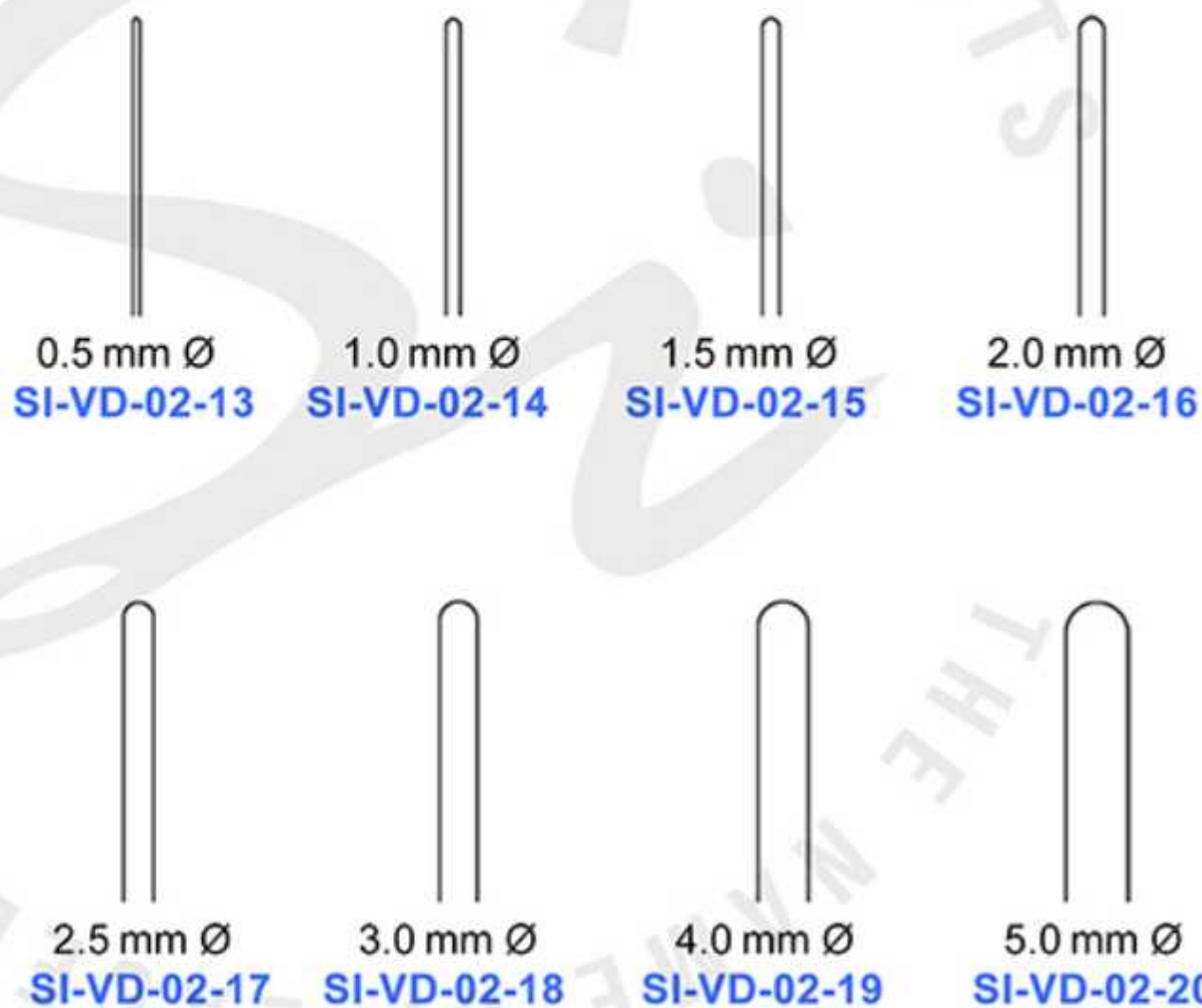

***Si* SURGICA**
INSTRUMENTS
THE NAME OF EXCELLENCE



MISCELLANEOUS

- NAIL INSTRUMENTS
- FINGER RING SAWS
- LUPUS CURETTES
- HOOKLETS
- TREPHINES
- COMEDONE EXTRACTORS
- STERILIZING FORCEPS – WASTE FORCEPS

Instruments à ongles
Nail instruments
Instrumentos para uñas
Strumenti per unghie



Fig. 1

SI-NI-10-01A

Set

Fig. 2

SI-NI-10-01B

Fig. 3

SI-NI-10-01C

Martin-Ideal

SI-NI-10-01

Complete with Fig. 1 – 3



Feldheim

100 mm – 4 "

SI-NI-10-02

Tourniquet for fingers and toes

MISCELLANEOUS

Instruments à ongles
Nail instruments
Instrumentos para uñas
Strumenti per unghie



Radolf
135 mm – 5 1/4 "
SI-NI-10-03



Anvil
125 mm – 5 "
SI-NI-10-04

Scies pour couper des bagues
Finger ring saws
Sierras para abrir anillos
Seghe per anelli



Finger ring saw
170 mm – 6 3/4 "
SI-FRS-1-01

SI-FRS-1-01A
Blade only



Walton
160 mm – 6 1/4 "
SI-FRS-1-02

SI-FRS-1-02A
Blade only



Finger ring saw
170 mm – 6 3/4 "
SI-FRS-1-03

SI-FRS-1-03A
Blade only

Curettes pour les lupus
Lupus curettes
Curetas para lupus
Curette per lupus



Vidal
140mm -5 1/2 "
SI-LC-12-01



Fox
140mm -5 1/2 "

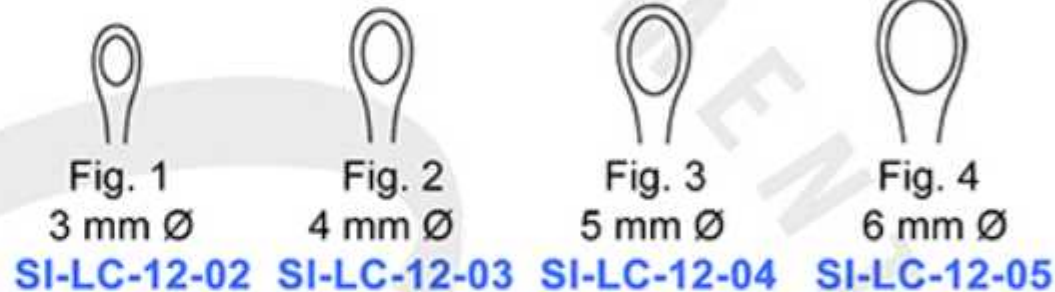

Wolff
140mm

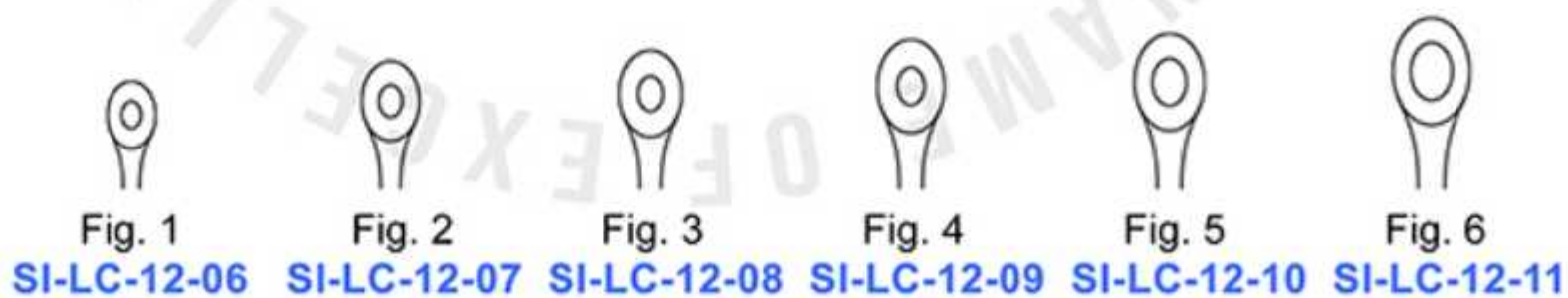

Crochets
Hooklets
Ganchos
Uncini

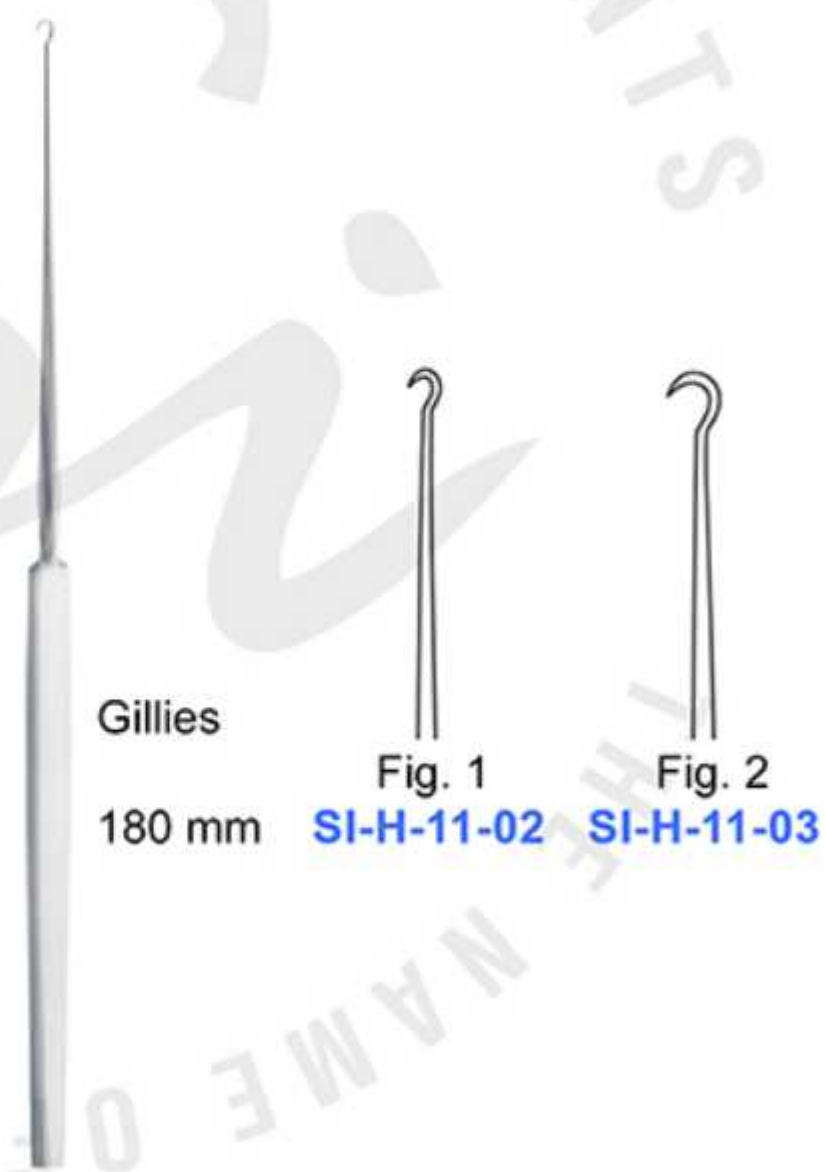

Trépan
Trepines
Trépanos
Trefine



Keyes
120 mm – 4 3/4 "

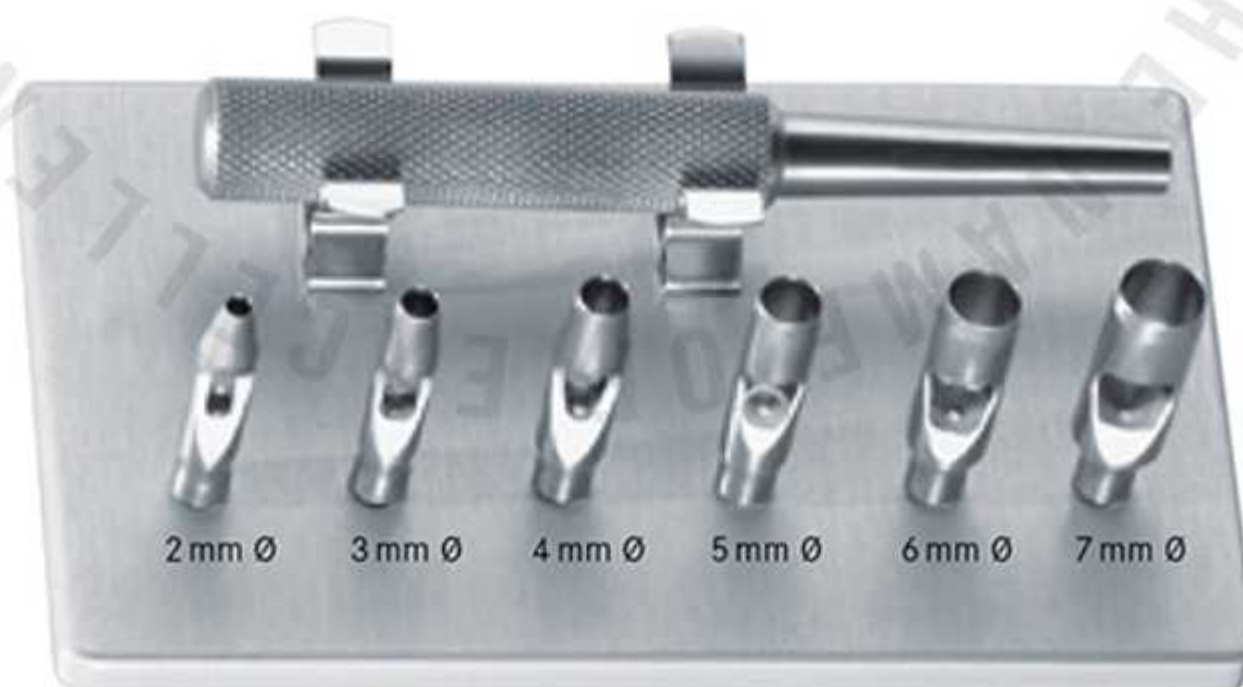

Keyes
SI-T-13-02
Punch – complete with 6 interchangeable tips, Ø 2mm – 7mm

MISCELLANEOUS

Tire-comédons
Comedone extractors
Saca-comedones
Tiracomedoni



Unna
140 mm – 5 1/2 "
SI-CE-09-01



Unna
140 mm – 5 1/2 "
SI-CE-09-02



Saalfeld
100 mm – 4 "
SI-CE-09-03



Saalfeld
140 mm – 5 1/2 "
SI-CE-09-04



Schamberg
100 mm – 4 "
SI-CE-09-05



Katsch
140 mm – 5 1/2 "
SI-CE-09-06

Pinces à stérilisation – pincés à déchets
Sterilizing forceps – waste forceps
Pinzas de esterilización – pinzas de basuras
Pinze per sterilizzazione – pinze per rifiuti



Cheatle
270 mm – 10 3/4 "
SI-SF-WF-01



Rogge
230 mm – 9 "
SI-SF-WF-02

Pinces à stérilisation – pincas à déchets
Sterilizing forceps – waste forceps
Pinzas de esterilización – pinzas de basuras
Pinze per sterilizzazione – pinze per rifiuti

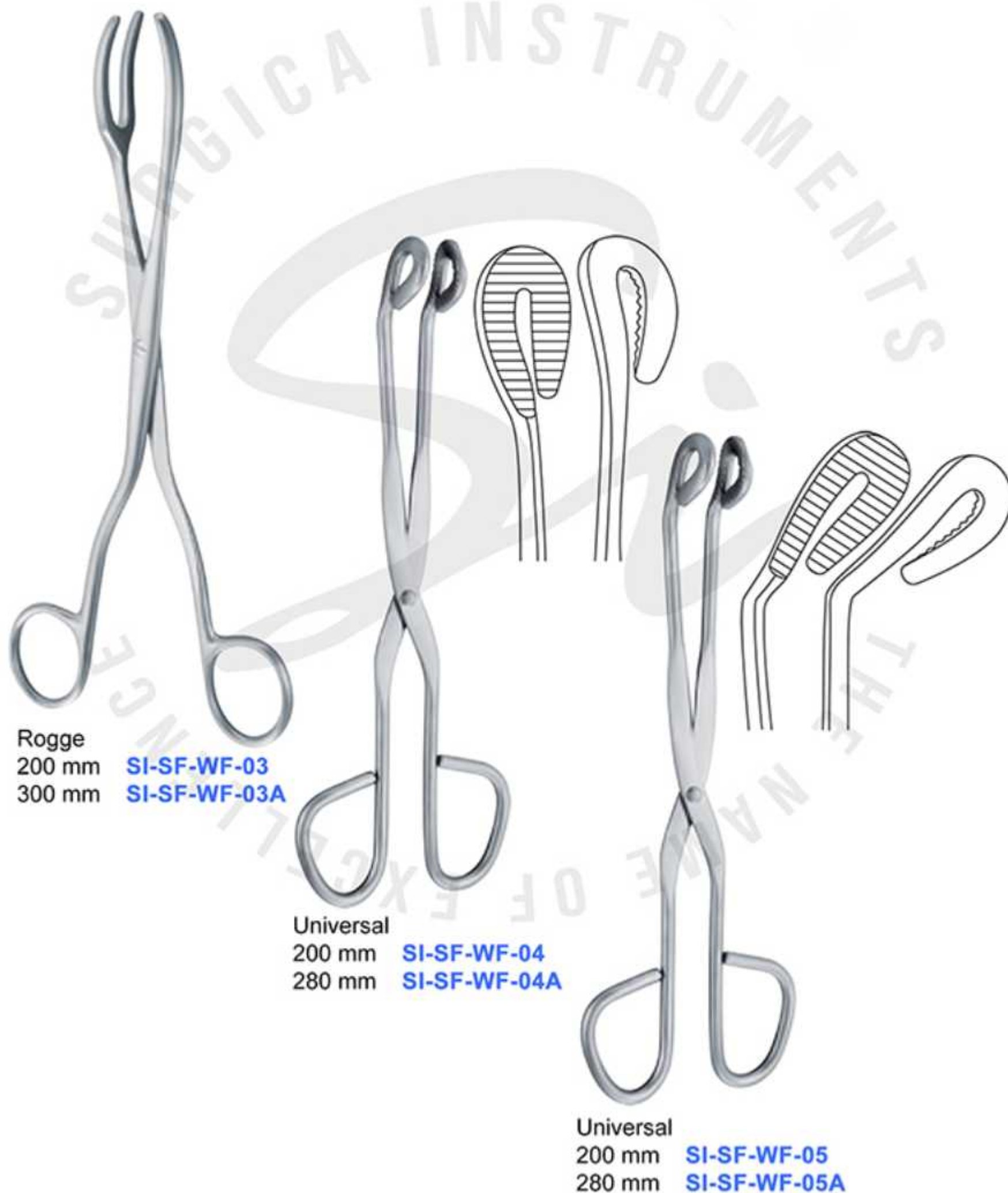

Pinces à stérilisation – pincas à déchets
Sterilizing forceps – waste forceps
Pinzas de esterilización – pinzas de basuras
Pinze per sterilizzazione – pinze per rifiuti



SI-SF-WF-06

SI-SF-WF-07

250 mm – 9 3/4 "
320 mm – 12 1/2 "
1 Tampon forceps, curved, with ratchet with lid for jar
1 Jar with wide bottom plate

Tambours de stérilisateur
Sterilizer Drums
Sterilisatortrommeln
Tambores esterilizadores



Round Sterilizer Drum
Stainless Steel

Available Size:

125 x 80	SI-HW-01
125 x 100	SI-HW-01-1
125 x 125	SI-HW-01-2
150 x 80	SI-HW-01-3
150 x 100	SI-HW-01-4
150 x 150	SI-HW-01-5
190 x 125	SI-HW-01-6
190 x 145	SI-HW-01-7
190 x 165	SI-HW-01-8

Tambours de stérilisateur
Sterilizer Drums
Sterilisatortrommeln
Tambores esterilizadores



Round Sterilizer Drum With Filter
Stainless Steel
Available Size:

125 x 80	SI-HW-02	240 x 145	SI-HW-02-9
125 x 100	SI-HW-02-1	240 x 190	SI-HW-02-10
125 x 125	SI-HW-02-2	240 x 240	SI-HW-02-11
150 x 80	SI-HW-02-3	340 x 145	SI-HW-02-12
150 x 100	SI-HW-02-4	340 x 165	SI-HW-02-13
150 x 150	SI-HW-02-5	340 x 340	SI-HW-02-14
190 x 125	SI-HW-02-6	390 x 340	SI-HW-02-15
190 x 145	SI-HW-02-7	390 x 390	SI-HW-02-16
190 x 165	SI-HW-02-8	390 x 490	SI-HW-02-17

HOLLOWARE INSTRUMENTS

Boîtes à instruments
Instruments Boxes
Instrumentenkisten
Cajas de instrumentos



Instruments Box With Lid
Stainless Steel

Available Size:

170 x 70 x 30	SI-HW-03
180 x 80 x 40	SI-HW-03-1
180 x 60 x 40	SI-HW-03-2
180 x 90 x 40	SI-HW-03-3
200 x 100 x 40	SI-HW-03-4
200 x 100 x 50	SI-HW-03-5
220 x 120 x 50	SI-HW-03-6
300 x 180 x 50	SI-HW-03-7
300 x 200 x 50	SI-HW-03-8

Instruments Box With Lid With Knob
Stainless Steel

Available Size:

165 x 90 x 35	SI-HW-04
200 x 100 x 50	SI-HW-04-1
230 x 130 x 50	SI-HW-04-2
300 x 180 x 50	SI-HW-04-3
300 x 200 x 50	SI-HW-04-4



HOLLOWARE INSTRUMENTS

Chaudières
Instruments Boilers
Instrumente Kessel
Instrumentos Calderas



Instruments Boiler
Stainless Steel

Available Size:

200 x 110 x 50	SI-HW-05
240 x 160 x 50	SI-HW-05-1
300 x 180 x 65	SI-HW-05-2
360 x 210 x 70	SI-HW-05-3
400 x 230 x 80	SI-HW-05-4

Instruments Boiler
Stainless Steel

Available Size:

180 x 80 x 40	SI-HW-06
200 x 100 x 60	SI-HW-06-1
220 x 120 x 60	SI-HW-06-2
250 x 120 x 60	SI-HW-06-3
300 x 125 x 60	SI-HW-06-4
400 x 160 x 75	SI-HW-06-5



HOLLOWWARE INSTRUMENTS

Plateaux d'instruments
Instruments Trays
Instrumentenablagen
Bandejas de instrumentos



Instruments Tray Without Cover
Stainless Steel

Available Size:

200 x 150 x 25	SI-HW-07
260 x 180 x 30	SI-HW-07-1
300 x 220 x 30	SI-HW-07-2
350 x 250 x 40	SI-HW-07-3
220 x 200 x 50	SI-HW-07-4
280 x 200 x 50	SI-HW-07-5
370 x 270 x 70	SI-HW-07-6
460 x 360 x 55	SI-HW-07-7

Scaler Tray
Stainless Steel

Available Size:

190 x 100 x 15 **SI-HW-08**



HOLLOWARE INSTRUMENTS

Plats de rein
Kidney Dishes
Nierengerichte
Platos de riñón



Kidney Dish With Cover
Stainless Steel

Available Size:

160 mm	SI-HW-09
200 mm	SI-HW-09-1
250 mm	SI-HW-09-2
280 mm	SI-HW-09-3



Kidney Dish
Stainless Steel

Available Size:

150 mm	SI-HW-10
200 mm	SI-HW-10-1
250 mm	SI-HW-10-2
270 mm	SI-HW-10-3
300 mm	SI-HW-10-4



Kidney Dish Sallow
Stainless Steel

Available Size:

150 mm	SI-HW-11
200 mm	SI-HW-11-1
250 mm	SI-HW-11-2
270 mm	SI-HW-11-3
300 mm	SI-HW-11-4

HOLLOWWARE INSTRUMENTS

Pot à vinaigrette, irrigateur, bols
Dressing Jar, Irrigator, Bowls
Dressing Jar, Irrigator, Schalen
Tarro de aderezo, irrigador, tazones



Dressing Jar
Stainless Steel

Available Size:

75 x 75 mm	SI-HW-12
100 x 100 mm	SI-HW-12-1
125 x 125 mm	SI-HW-12-2
150 x 150 mm	SI-HW-12-3
180 x 180 mm	SI-HW-12-4
200 x 200 mm	SI-HW-12-5
300 x 300 mm	SI-HW-12-6



Round Bowl With Cover
Stainless Steel

Available Size:

40 mm	30 ml	SI-HW-13
60 mm	50 ml	SI-HW-13-1
80 mm	150 ml	SI-HW-13-2
100 mm	250 ml	SI-HW-13-3
120 mm	450 ml	SI-HW-13-4
200 mm	500 ml	SI-HW-13-5
250 mm	1500 ml	SI-HW-13-6



Irrigator
Stainless Steel

Available Size:

1000 ml	SI-HW-14
1500 ml	SI-HW-14-1
2000 ml	SI-HW-14-2

HOLLOWARE INSTRUMENTS

Bols ronds et à solution
Round & Solution Bowls
Runde & Lösungsschalen
Cuencos redondos y de solución



Round Bowls
Stainless Steel
Available Size:

200 x 150 x 25	SI-HW-15
260 x 180 x 30	SI-HW-15-1
300 x 220 x 30	SI-HW-15-2
350 x 250 x 40	SI-HW-15-3
220 x 200 x 50	SI-HW-15-4
280 x 200 x 50	SI-HW-15-5
370 x 270 x 70	SI-HW-15-6
460 x 360 x 55	SI-HW-15-7



Solution Bowls
Stainless Steel
Available Size:

300 x 72 mm	SI-HW-16
320 x 85 mm	SI-HW-16-1
350 x 120 mm	SI-HW-16-2
405 x 95 mm	SI-HW-16-3

HOLLOWWARE INSTRUMENTS

Septum Tasse et Pot À Mesurer
Septum Cup & Measuring Jar
Septum Cup & Messbecher
Vaso para septum v tarro medidor



Septum Cup
Stainless Steel
SI-HW-17



Measuring Jar
Stainless Steel
Available Size:
500 ml **SI-HW-18**
1000 ml **SI-HW-18-1**
1500 ml **SI-HW-18-2**
2000 ml **SI-HW-18-3**

Porte-coton
Cotton Holders



Cotton Holder
Stainless Steel
SI-HW-19



Cotton Holder
Stainless Steel
SI-HW-20

HOLLOWARE INSTRUMENTS

Lampes à alcool
Alcohol Lamps
Alkohollampen
Lámparas de alcohol



Alcohol Lamp
Stainless Steel

Available Size:

50 cc **SI-HW-21**

100 cc **SI-HW-21-1**



Alcohol Lamp With Flam Control
Stainless Steel

SI-HW-22

Lampes à alcool
Alcohol Lamps
Alkohollampen
Lámparas de alcohol



Alcohol Lamp Standard
Stainless Steel
SI-HW-23

HOLLOWARE INSTRUMENTS

Bocal à pinces et récipient en coton
Forceps Jar & Cotton Container
Pinzettenglas & Baumwollbehälter
Tarro de fórceps y contenedor de algodón



Forceps Jar
Stainless Steel

Available Size:

50 x 100	SI-HW-24
50 x 150	SI-HW-24-1
50 x 175	SI-HW-24-2
75 x 100	SI-HW-24-3
75 x 175	SI-HW-24-4
100 x 175	SI-HW-24-5
125 x 250	SI-HW-24-6



Cotton Container
Stainless Steel

Available Size:

75 x 75	SI-HW-25
100 x 100	SI-HW-25-1
125 x 125	SI-HW-25-2
150 x 150	SI-HW-25-3
180 x 180	SI-HW-25-4
200 x 200	SI-HW-25-5

HOLLOWWARE INSTRUMENTS

Pots d'urinoirs masculins et féminins
Male & Female Urinal Pots
Urinal-Töpfe für Männer und Frauen
Urinaros masculinos y femeninos



Male Urinal Pot
Stainless Steel
SI-HW-26



Female Urinal Pot
Stainless Steel
SI-HW-27

HOLLOWWARE INSTRUMENTS

Pots d'urinoirs masculins et féminins
Male & Female Urinal Pots
Urinal-Töpfe für Männer und Frauen
Urinaros masculinos y femeninos



Female Urinal Pot
Stainless Steel
SI-HW-28



Male Urinal Pot
Stainless Steel
1500 ml
SI-HW-29

Bassin
Bedpan
Bettpfanne
Calentador de cama



Bedpan Adult
Stainless Steel
SI-HW-30



Male Bedpan With Cover
Stainless Steel
SI-HW-31

Bassin
Bedpan
Bettpfanne
Calentador de cama



Male Bedpan With Cover
Stainless Steel
SI-HW-32

Bassin
Bedpan
Bettpfanne
Calentador de cama



Round BedPan With Cover
Stainless Steel
Size: 235 mm
SI-HW-33



Round BedPan With Cover
Stainless Steel
Size: 310 mm
SI-HW-34



Si



SURGICA INSTRUMENTS

SURGICA UNIT ADDRESS
MUHAMMAD PURA COMMISSIONER
ROAD, SIALKOT-51310, PAKISTAN

TEL: +92 52 4598741

MOBILE: +92 312 7782800

EMAIL: INFO@SURGICA-INTL.COM

EMAIL: ASLAM@SURGICA-INTL.COM

WEBSITE: WWW.SURGICA-INTL.COM

REGARDS

MIAN MUHAMMAD ASLAM

CEO

TEL: +92 52 4598741

MOBILE: +92 337 0464548

EMAIL: ASAD@SURGICA-INTL.COM

WEBSITE: WWW.SURGICA-INTL.COM

REGARDS,

ASAD ALI

MANAGING DIRECTOR