

# Si Surgica

Instruments



High Quality Dental Instruments





Zahnzangen, Englische Form  
 Extracting Forceps, English Pattern  
 Pinze per estrazione, Forma Inglese  
 Pinzas da extracción, Forma Inglesa  
 Daviers, Forme Anglaise

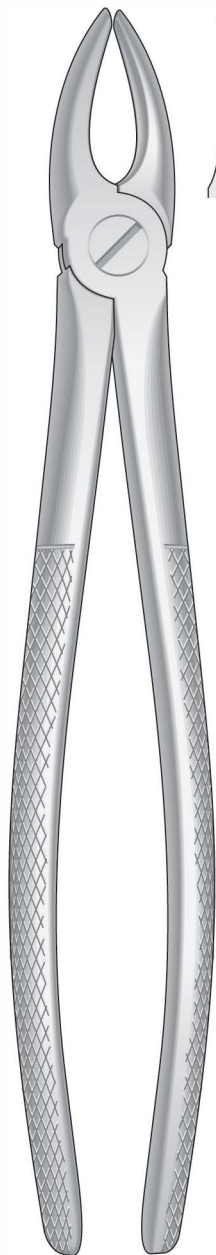

**SI-10001**  
 Fig. 1

Obere Schneide- und Eckzähne  
 Upper Incisors and cuspids  
 Incisivi e canini superiori  
 Incisivos y caninos superiores  
 Incisives et canines supérieures

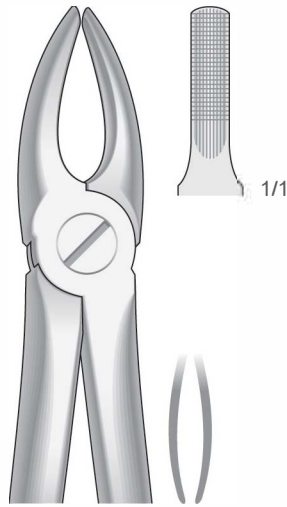

**SI-10002**  
 Fig. 2

Obere Schneide- und Eckzähne  
 Upper Incisors and cuspids  
 Incisivi e canini superiori  
 Incisivos y caninos superiores  
 Incisives et canines supérieures

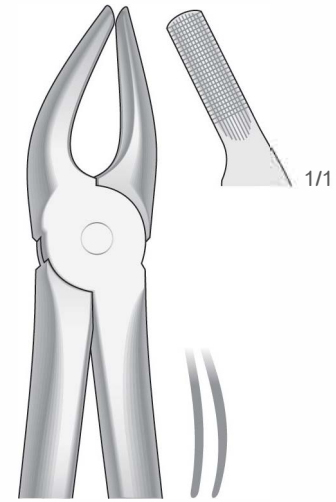

**SI-10003**  
 Fig. 7

Obere Prämolaren  
 Upper premolars  
 Premolari superiori  
 Premolares superiores  
 Prémolaires supérieures

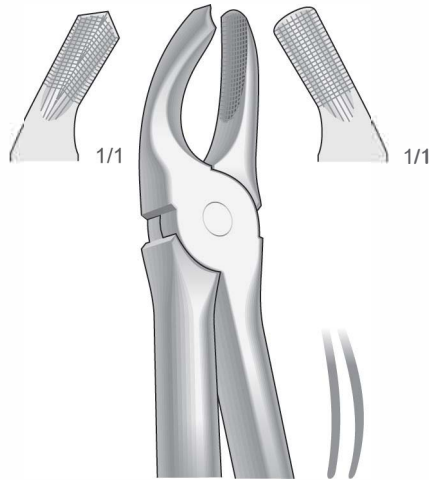

**SI-10004**  
 Fig. 17

Obere Molaren, rechts  
 Upper molars, right  
 Molari superiori, destra  
 Molares superiores, derechos  
 Molaires supérieures, droites

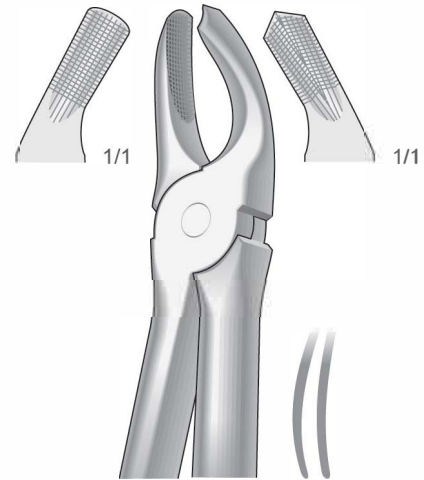

**SI-10005**  
 Fig. 18

Obere Molaren, links  
 Upper molars, left  
 Molari superiori, sinistra  
 Molares superiores, izquierdos  
 Molaires supérieures, gauches





Zahnzangen, Englische Form  
Extracting Forceps, English Pattern  
Pinze per estrazione, Forma Inglese  
Pinzas da extracción, Forma Inglesa  
Daviers, Forme Anglaise

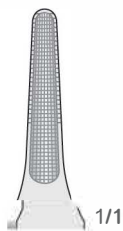

1/1

Obere Wurzeln und Schneidezähne  
Upper Roots and incisors  
Radici e incisivi superiori  
Raíces y incisivos superiores  
Racines et incisives supérieures

**SI-10006**  
Fig. 29

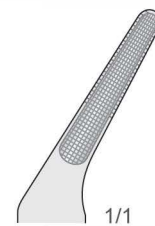

1/1

Obere Wurzeln  
Upper Roots  
Radici superiori  
Raíces superiores  
Racines supérieures

**SI-10007**  
Fig. 30



Zahnzangen, Englische Form  
Extracting Forceps, English Pattern  
Pinze per estrazione, Forma Inglese  
Pinzas da extracción, Forma Inglesa  
Daviers, Forme Anglaise

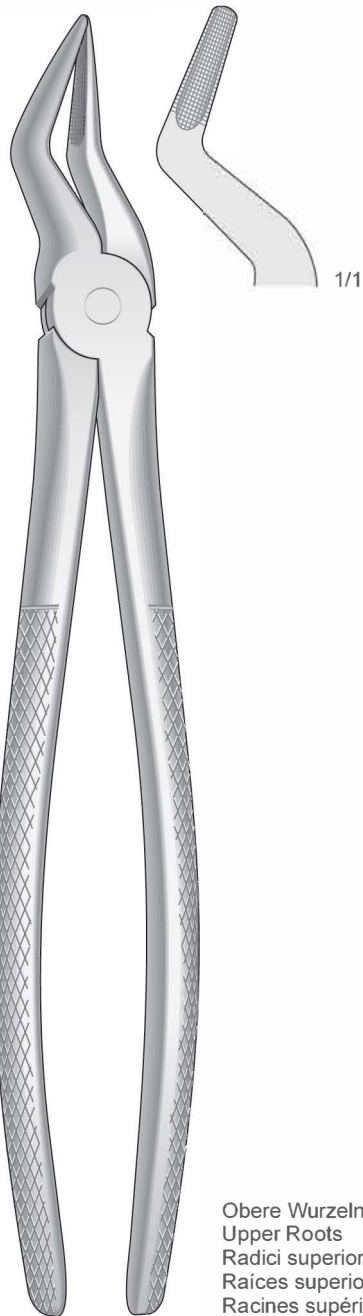

**SI-10011**  
Fig. 51

Obere Wurzeln  
Upper Roots  
Radici superiori  
Raíces superiores  
Racines supérieures

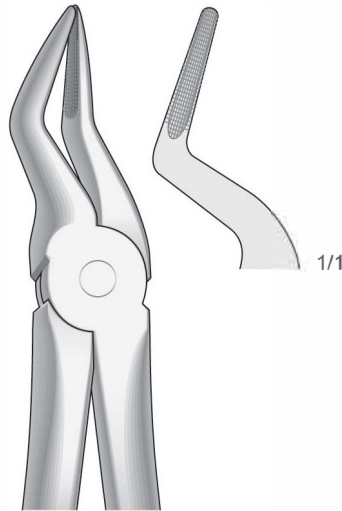

**SI-10008**  
Fig. 51A

Obere Wurzeln  
Upper Roots  
Radici superiori  
Raíces superiores  
Racines supérieures

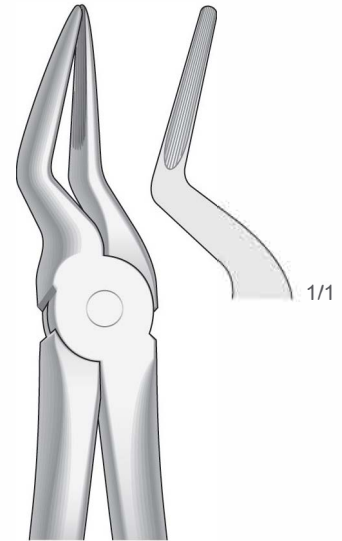

**SI-10009**  
Fig. 51AL

Obere Wurzeln  
Upper Roots  
Radici superiori  
Raíces superiores  
Racines supérieures

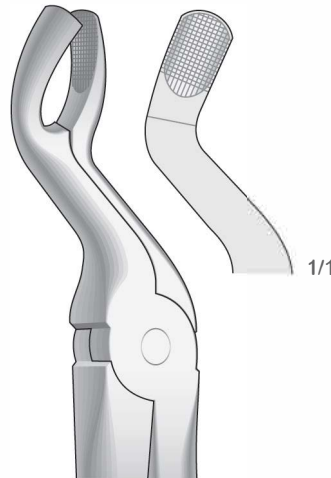

**SI-10010**  
Fig. 67A

Obere Dritte Molaren - Für Obere Weisheitszähne  
Upper molars - For Upper wisdom teeth  
Ottavi superiori - Per denti del giudizio superiori  
Molares superiores - Para muelas del juicio superiores  
Molaires supérieures - Pour dents de sagesse supérieures





Zahnzangen, Englische Form  
Extracting Forceps, English Pattern  
Pinze per estrazione, Forma Inglese  
Pinzas da extracción, Forma Inglesa  
Daviers, Forme Anglaise

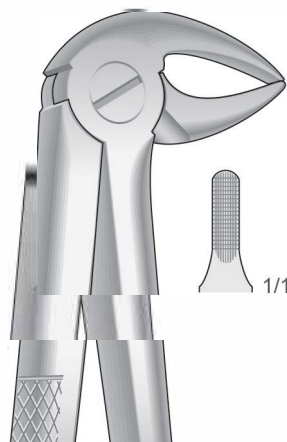

**SI-10012**  
Fig. 33

Untere Prämolaren, Schneidezähne und Wurzeln  
Lower incisors, premolars and roots  
Incisivi, premolari e radici inferiori  
Incisivos, premolares y raíces inferiores  
Incisives, prémolaires et racines inférieures

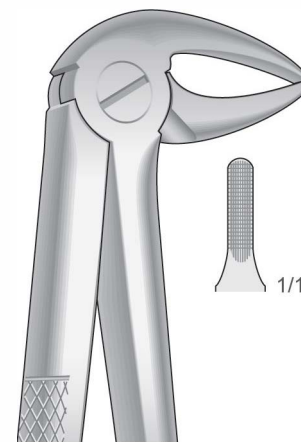

**SI-10013**  
Fig. 33A

Untere Wurzeln, schlankes Maul  
Lower roots, Slender jaw  
Radici inferiori, morso stretto  
Raíces inferiores, boca estrecha  
Racines inférieures, avec un bec très fin



**SI-10016**  
Fig. 13

Untere Eckzähne und Prämolaren  
Lower cuspids and premolars  
Canini e premolari inferiori  
Caninos y premolares inferiores  
Canines et prémolaires inférieures

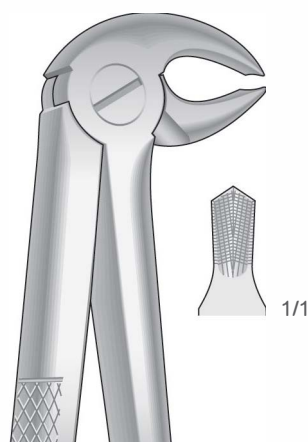

**SI-10014**  
Fig. 22

Untere Molaren  
Lower molars  
Molari inferiori  
Molares inferiores  
Molaires inférieures



**SI-10015**  
Fig. 73

Untere Molaren  
Lower molars  
Molari inferiori  
Molares inferiores  
Molaires inférieures



Zahnzangen, Englische Form  
Extracting Forceps, English Pattern  
Pinze per estrazione, Forma Inglese  
Pinzas da extracción, Forma Inglesa  
Daviers, Forme Anglaise

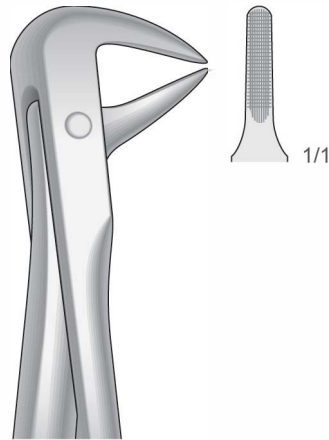

**SI-10017**  
Fig. 74N

Untere Wurzeln, schneide-und Eckzähne  
Lower roots, Incisors and bicuspid  
Radici, incisivi e canini inferiori  
Raíces, incisivos y caninos inferiores  
Racines, incisives et canines inférieures

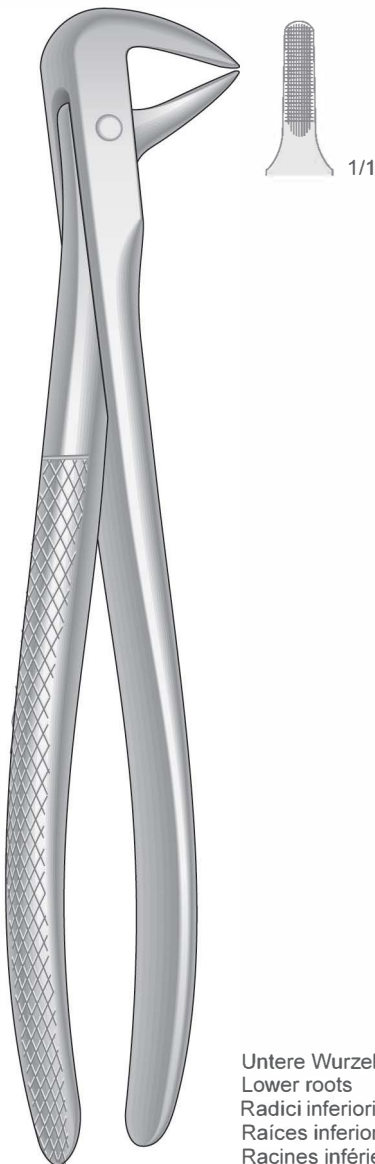

**SI-10019**  
Fig. 74

Untere Wurzeln  
Lower roots  
Radici inferiori  
Raíces inferiores  
Racines inférieures



**SI-10018**  
Fig. 75

Untere Eckzähne und Prämolaren  
Lower Cuspids and bicuspid  
Canini e premolari inferiori  
Caninos y premolares inferiores  
Canines et prémolaires inférieures

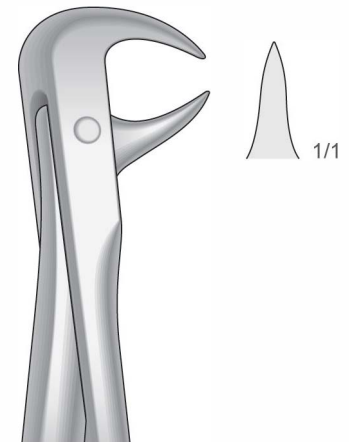

**SI-10018A**  
Fig. 86A

Untere Molaren  
Lower molars  
Molari inferiori  
Molares inferiores  
Molaires inférieures



Zahnzangen, Englische Form  
Extracting Forceps, English Pattern  
Pinze per estrazione, Forma Inglese  
Pinzas da extracción, Forma Inglesa  
Daviers, Forme Anglaise

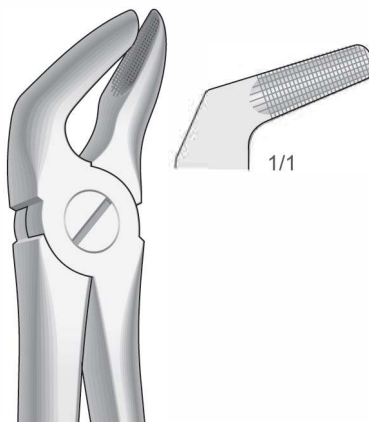

**SI-10020**  
Fig. 8

Untere Prämolaren  
Lower premolars  
Premolari inferiori  
Premolares inferiores  
Prémolaires inférieures

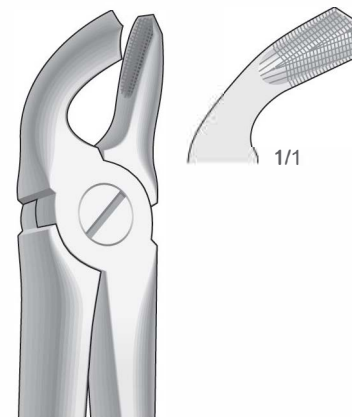

**SI-10021**  
Fig. 21

Untere Weisheitszähne und Molaren  
Lower wisdom teeth and molars  
Denti del giudizio e molari inferiori  
Muelas del juicio y Molares inferiores  
Dents de sagesse et molaires inférieures

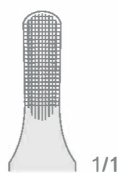

1/1

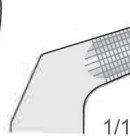

1/1

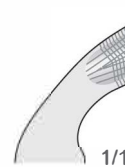

1/1



**SI-10024**  
Fig. 4

Untere Schneide- und Eckzähne  
Lower Incisors and cuspids  
Incisivi e canini inferiori  
Incisivos y caninos inferiores  
Incisives et canines inférieures

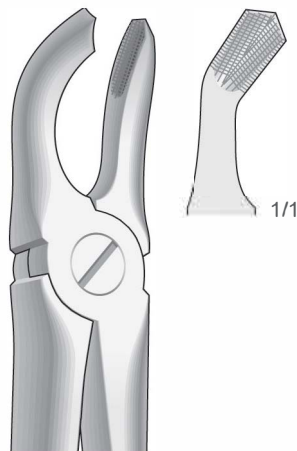

**SI-10022**  
Fig. 79

Untere Weisheitszähne  
Lower wisdom teeth  
Denti del giudizio inferiori  
Muelas del juicio inferiores  
Dent de sagesse inférieures

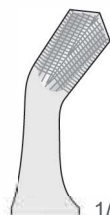

1/1

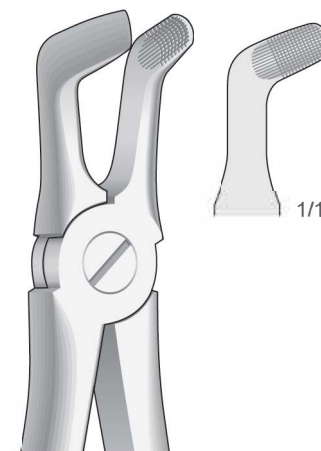

**SI-10023**  
Fig. 79A

Untere Molaren und Weisheitszähne  
Lower molars and wisdom teeth  
Molari e denti del giudizio inferiori  
Molares y muelas del juicio inferiores  
Molaires et dent de sagesse inférieures

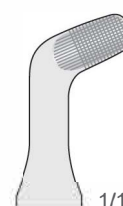

1/1





Zahnzangen, Englische Form  
Extracting Forceps, English Pattern  
Pinze per estrazione, Forma Inglese  
Pinzas da extracción, Forma Inglesa  
Daviers, Forme Anglaise

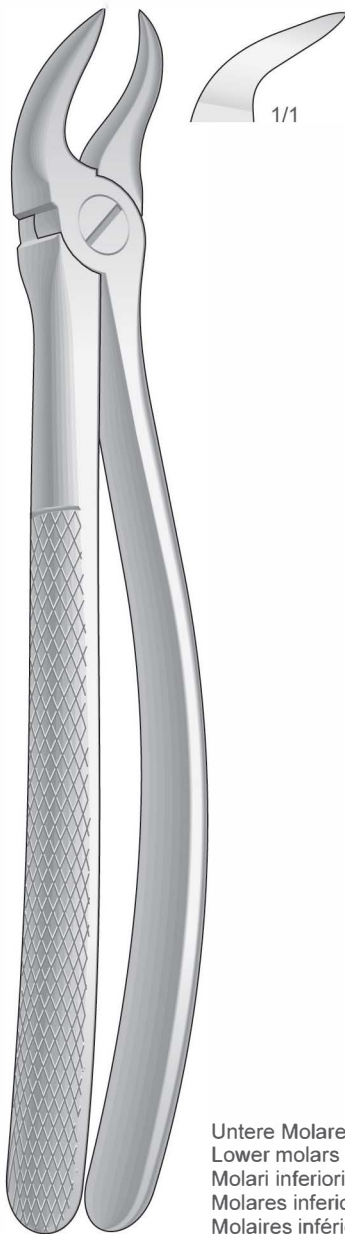

SI-10027  
Fig. 87

Untere Molaren  
Lower molars  
Molari inferiori  
Molares inferiores  
Molaires inférieures

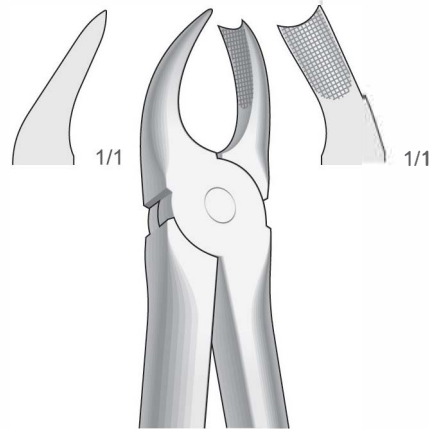

SI-10025  
Fig. 89

Obere Molaren, rechts  
Upper molars, right  
Molari superiori, destra  
Molares superiores, derechos  
Molaires supérieures, droites

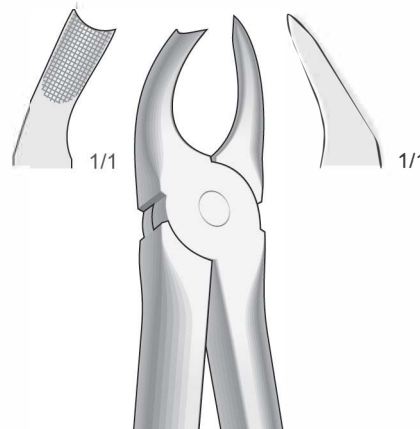

SI-10026  
Fig. 90

Obere Molaren, links  
Upper molars, left  
Molari superiori, sinistra  
Molares superiores, izquierdos  
Molaires supérieures, gauches



Zahnzangen, Englische Form  
 Extracting Forceps, English Pattern  
 Pinze per estrazione, Forma Inglese  
 Pinzas da extracción, Forma Inglesa  
 Daviers, Forme Anglaise



**SI-10031**  
 Fig. 68

Untere Wurzeln  
 Lower Roots  
 Radici inferiori  
 Raíces inferiores  
 Racines inférieures



**SI-10030**  
 Fig. 68A

Untere Wurzeln  
 Lower Roots  
 Radici inferiori  
 Raíces inferiores  
 Racines inférieures

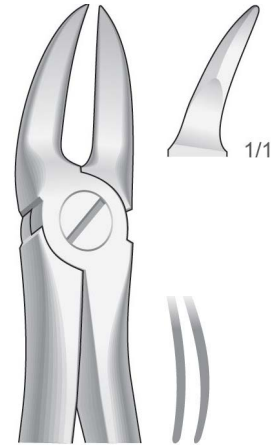

**SI-10028**  
 Fig. 55

Zum Trennen oberer Molarenwurzeln  
 For separating upper molar roots  
 Per radici dei molari superiori, presa in profondità  
 Para partir raíces de molares superiores, profundo  
 Pour séparer les racines des molaires supérieures

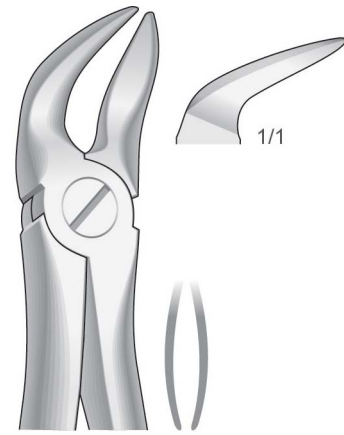

**SI-10029**  
 Fig. 56

Zum Trennen Unterer Molarenwurzeln  
 For separating lower molar roots  
 Per radici dei molari inferiori, presa in profondità  
 Para partir raíces de molares inferiores, profundo  
 Pour séparer les racines des molaires inférieures



Zahnzangen, Englische Form  
Extracting Forceps, English Pattern  
Pinze per estrazione, Forma Inglese  
Pinzas da extracción, Forma Inglesa  
Daviers, Forme Anglaise

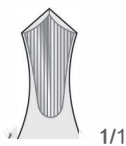

1/1

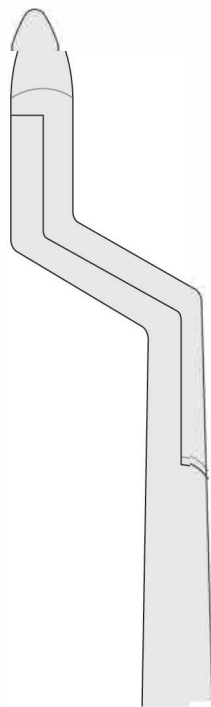

1/1

Untere Molaren und Weisheitszähne, rechts  
Lower molars and wisdom teeth, right  
Molari e denti del giudizio inferiori, a destra  
Molares y muelas del juicio inferiores, derecha  
Molaires et dent de sagesse inférieures, droites

**SI-10031A**

ROUTURIER  
22 ½ R

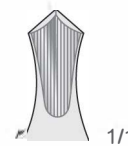

1/1

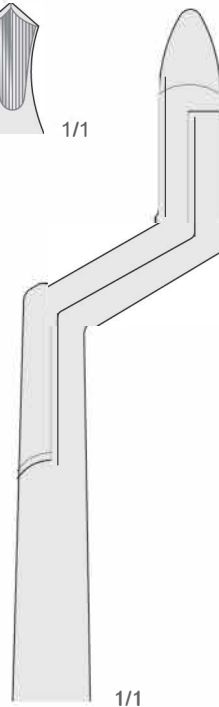

1/1

Untere Molaren und Weisheitszähne, links  
Lower molars and wisdom teeth, left  
Molari e denti del giudizio inferiori, a sinistra  
Molares y muelas del juicio inferiores, izquierda  
Molaires et dent de sagesse inférieures, gauches

**SI-10031B**

ROUTURIER  
22 ½ L





Zahnzangen, Englische Form  
Extracting Forceps, English Pattern  
Pinze per estrazione, Forma Inglese  
Pinzas da extracción, Forma Inglesa  
Daviers, Forme Anglaise

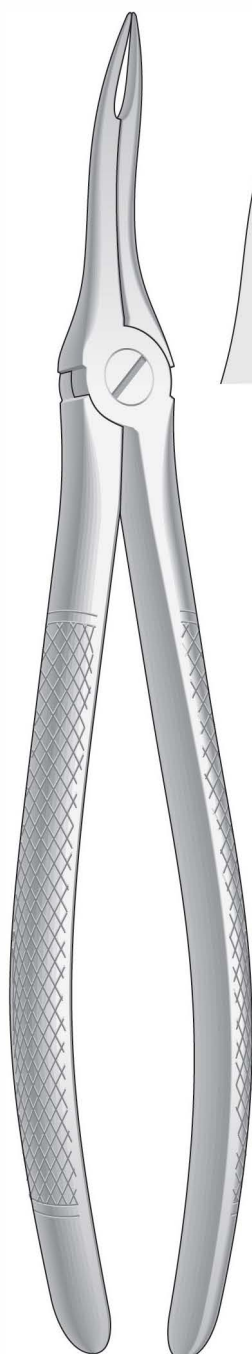

SI-10034  
Fig. 49

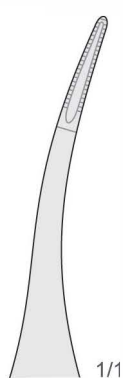

SI-10032  
Fig. 48 - 44

Obere Wurzeln  
Upper roots  
Radici superiori  
Raíces superiores  
Racines supérieures

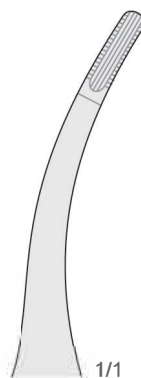

Obere Wurzeln sehr feine  
Upper very fine roots  
Radici superiori molto sottili  
Raíces superiores muy finas  
Racines supérieures très fines

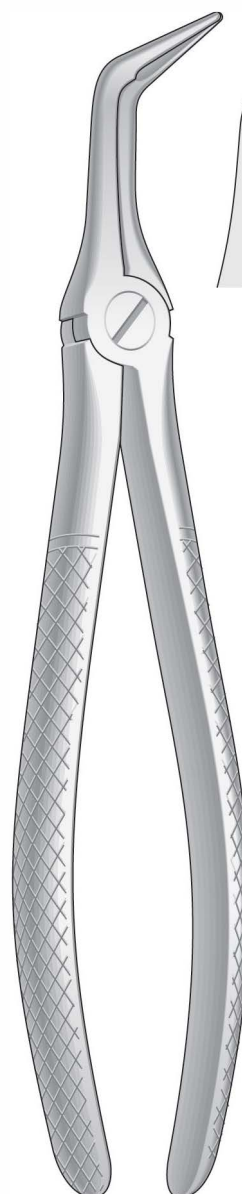

SI-10033  
Fig. 46L

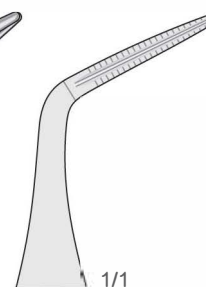

Untere Wurzeln  
Lower roots  
Radici inferiori  
Raíces inferiores  
Racines inférieures



Zahnzangen, Paßformgriff  
 Extracting Forceps, Anatomical Handle  
 Pinze per estrazione, Manico anatomico  
 Pinzas da extracción, Mango anatómico  
 Daviers, Manche anatomique

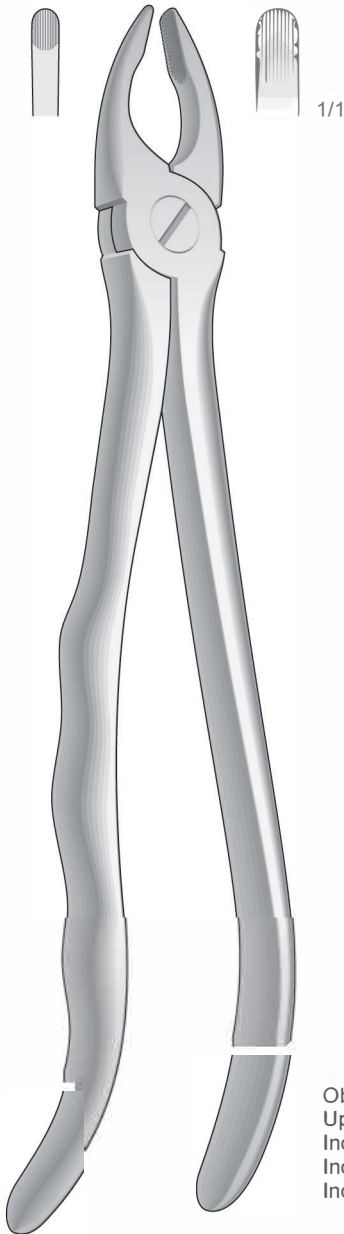

**SI-10038**  
 Fig. 3

Obere Schneide- und Eckzähne  
 Upper incisors and cuspids  
 Incisivi e canini superiori  
 Incisivos y caninos superiores  
 Incisives et canines supérieures

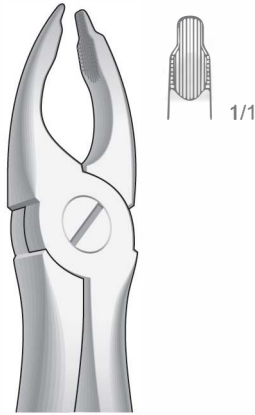

**SI-10035**  
 Fig. 34

Obere Schneide- und Eckzähne  
 Upper incisors and cuspids  
 Incisivi e canini superiori  
 Incisivos y caninos superiores  
 Incisives et canines supérieures

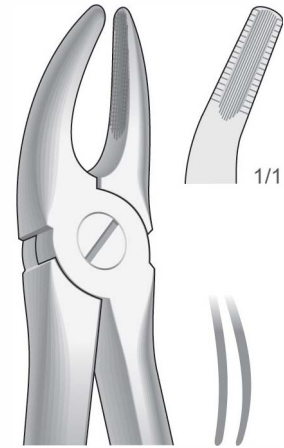

**SI-10036**  
 Fig. 7

Obere Prämolaren  
 Upper premolars  
 Premolari superiori  
 Premolares superiores  
 Prémolaires supérieures

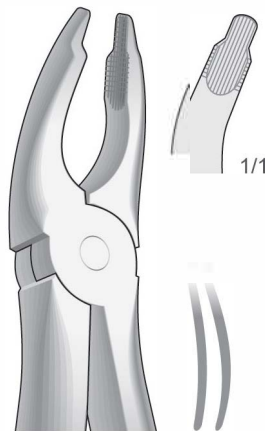

**SI-10037**  
 Fig. 35

Obere Schneidezähne und Prämolaren, tiefgreifend  
 Upper incisors and bicuspid, deep-gripping  
 Incisivi e premolari superiori, presa in profondità  
 Incisivos y premolares superiores, a gran calado  
 Incisives et prémolaires supérieures, à attaque profonde



Zahnzangen, Paßformgriff  
 Extracting Forceps, Anatomical  
 Handle Pinze per estrazione,  
 Manico anatomico Pinzas da  
 extracción, Mango anatómico  
 Daviers, Manche anatomique

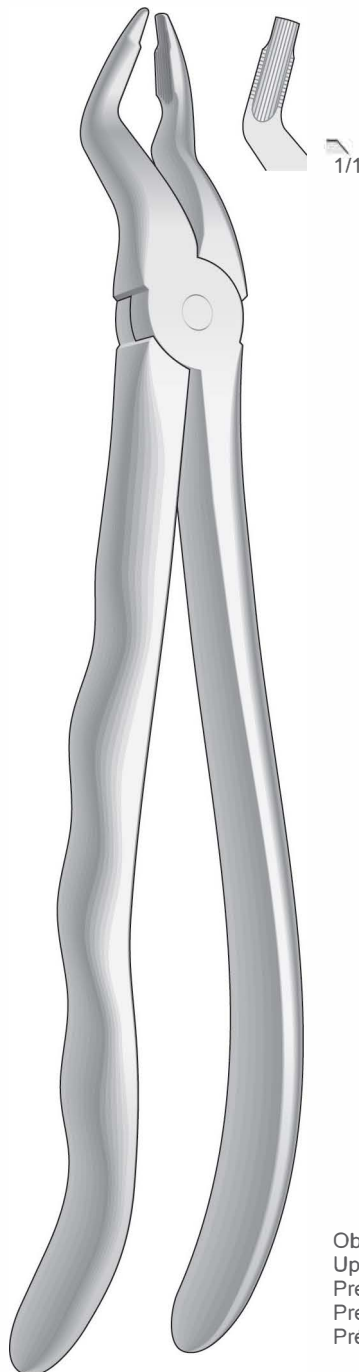

**SI-10041**  
 Fig. 31

Obere Prämolaren  
 Upper premolars  
 Premolari superiori  
 Premolares superiores  
 Prémolaires supérieures



1/1

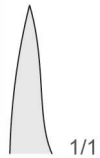

1/1

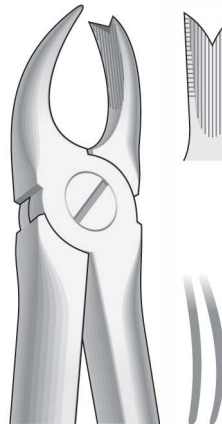

**SI-10039**  
 Fig. 66R (89)

Obere Molaren, rechts  
 Upper molars, right  
 Molari superiori, destra  
 Molares superiores, derechos  
 Molaires supérieures, droites



1/1



1/1

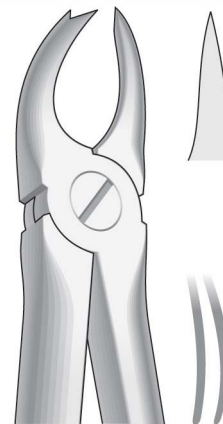

**SI-10040**  
 Fig. 66L (90)

Obere Molaren, links  
 Upper molars, left  
 Molari superiori, sinistra  
 Molares superiores, izquierdos  
 Molaires supérieures, gauches

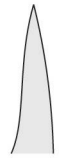

1/1





Zahnzangen, Paßformgriff  
Extracting Forceps, Anatomical Handle  
Pinze per estrazione, Manico anatomico  
Pinzas da extracción, Mango anatómico  
Daviers, Manche anatomique

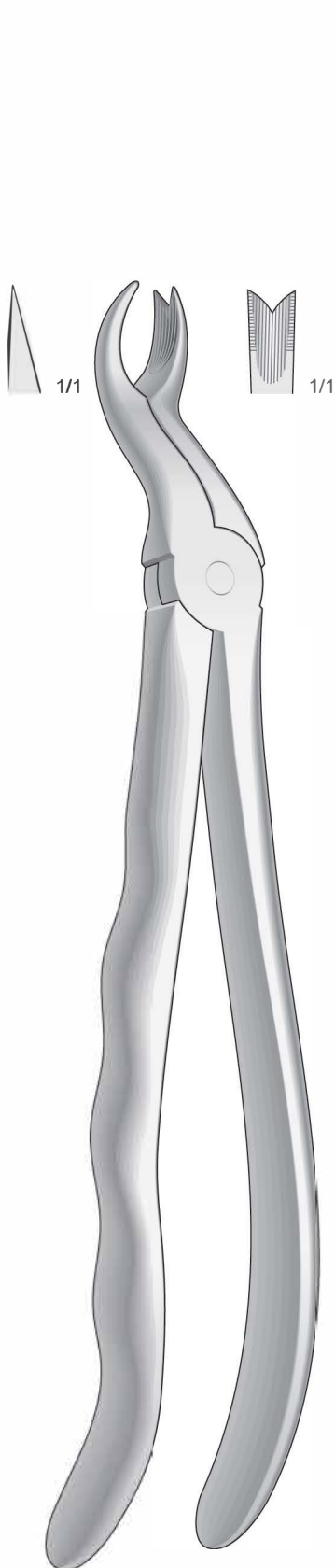

**SI-10044**  
Fig. 67R

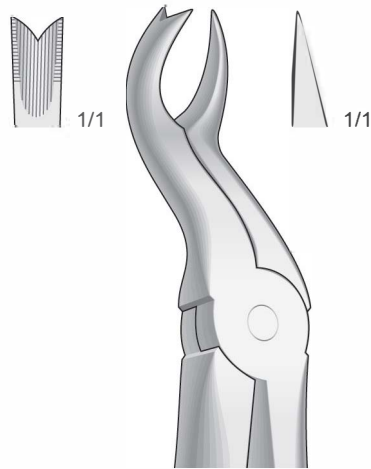

**SI-10042**  
Fig. 67L

Obere Molaren, links  
Upper molars, left  
Molari superiori, sinistra  
Molares superiores, izquierdos  
Molaires supérieures, gauches

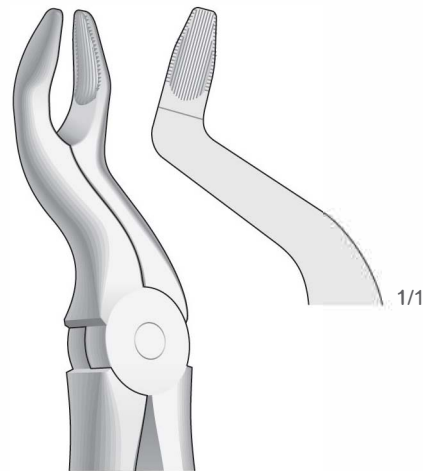

**SI-10043**  
Fig. 67N

Obere Molaren  
Upper molars  
Molari superiori  
Molares superiores  
Molaires supérieures

Obere Molaren, rechts  
Upper molars, right  
Molari superiori, destra  
Molares superiores, derechos  
Molaires supérieures, droites



Zahnzangen, Paßformgriff  
Extracting Forceps, Anatomical Handle  
Pinze per estrazione, Manico anatomico  
Pinzas da extracción, Mango anatómico  
Daviers, Manche anatomique

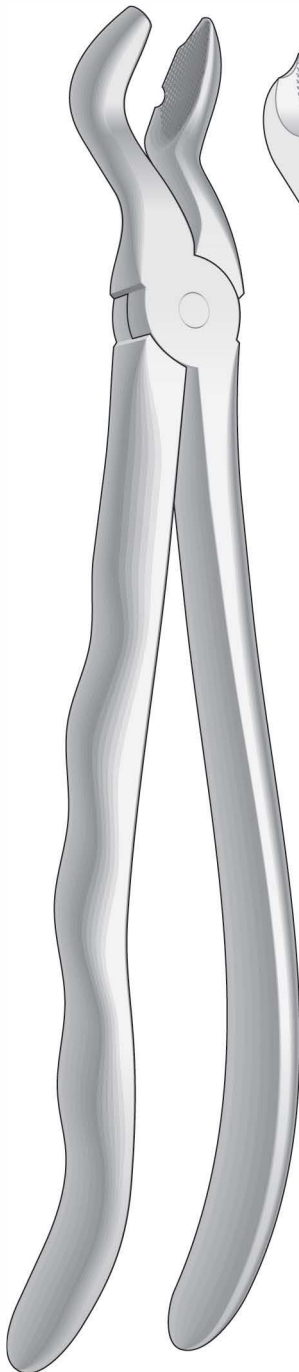

**SI-10048**  
FELSCH  
Fig. 80

Für obere Weisheitszähne, mit Fangvorrichtung  
For upper wisdom teeth, with retaining device  
Denti del giudizio superiori, con dispositivo di presa  
Muelas del juicio superiores, con dispositivo de retencion  
Pour dents de sagesse supérieures, mors conçus pour recueillir la dent

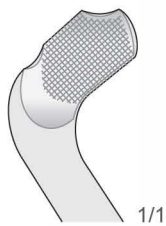

1/1

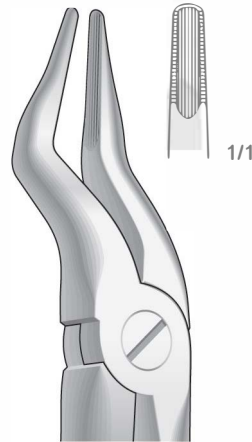

1/1

**SI-10045**  
Fig. 51B

Obere Dritte Molaren  
Upper molars  
Ottavi superiori  
Molares superiores  
Molaires supérieures

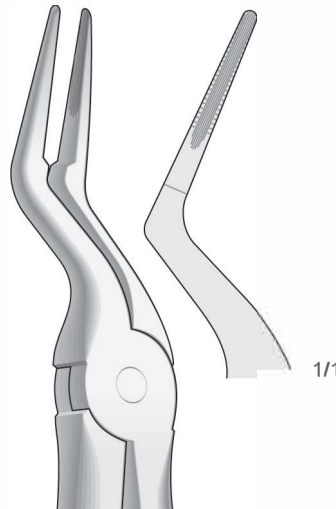

1/1

**SI-10046**  
Fig. 97

Obere Wurzelplitterzange  
Upper Root Fragments  
Frammenti e radici superiori  
Fragmentos de raíces superiores  
Fragments des racines supérieures

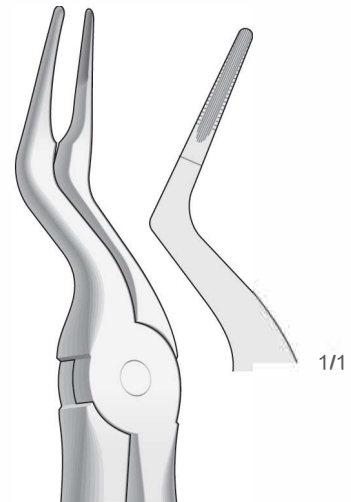

1/1

**SI-10047**  
Fig. 97B

Obere Wurzelplitterzange  
Upper Root Fragments  
Frammenti e radici superiori  
Fragmentos de raíces superiores  
Fragments des racines supérieures



Extracting Forceps, Anatomical Handle  
Pinze per estrazione, Manico anatomico  
Pinzas da extracción, Mango anatómico  
Daviers, Manche anatomique

Obere Wurzeln sehr feine  
Upper very fine roots  
Radici superiori molto sottili  
Raíces superiores muy finas  
Racines supérieures très fines

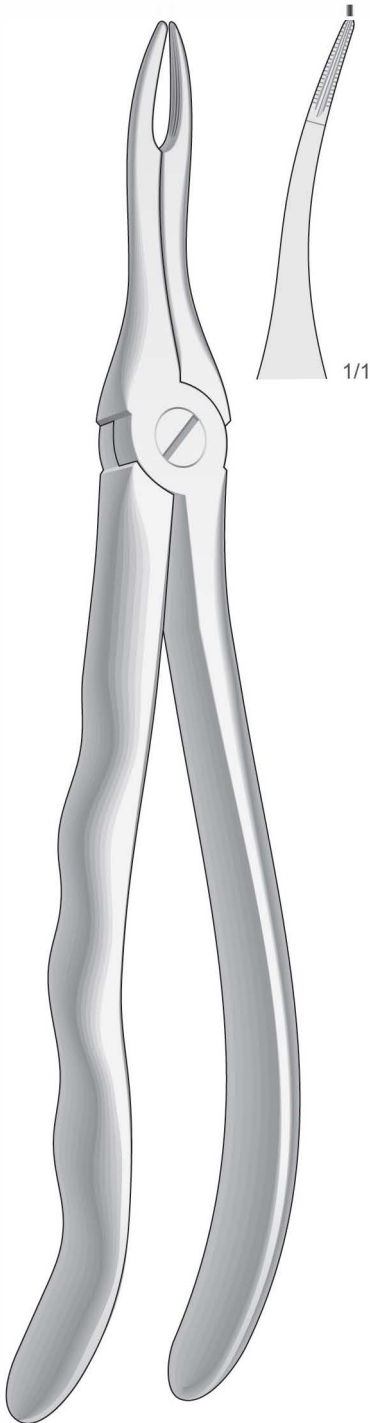

**SI-10049**  
Fig. 49

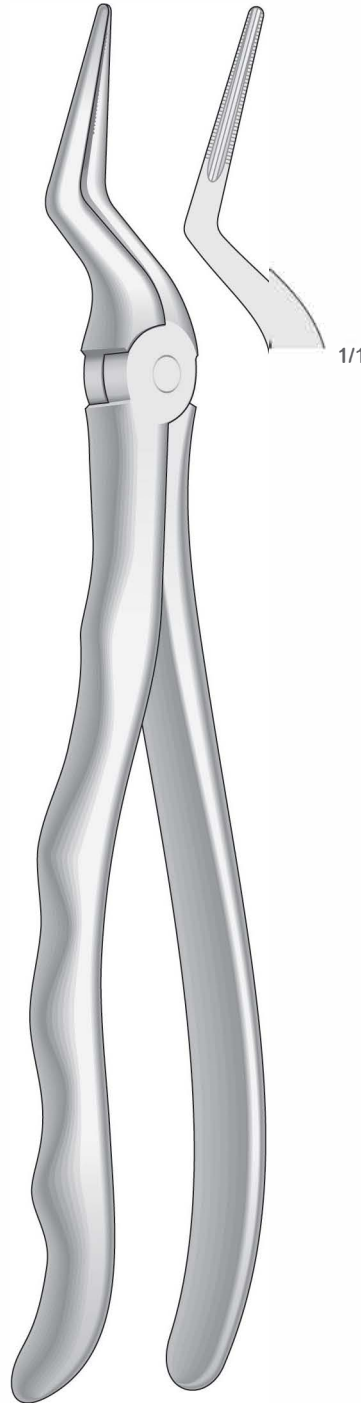

**SI-10050**  
Fig. 51LX

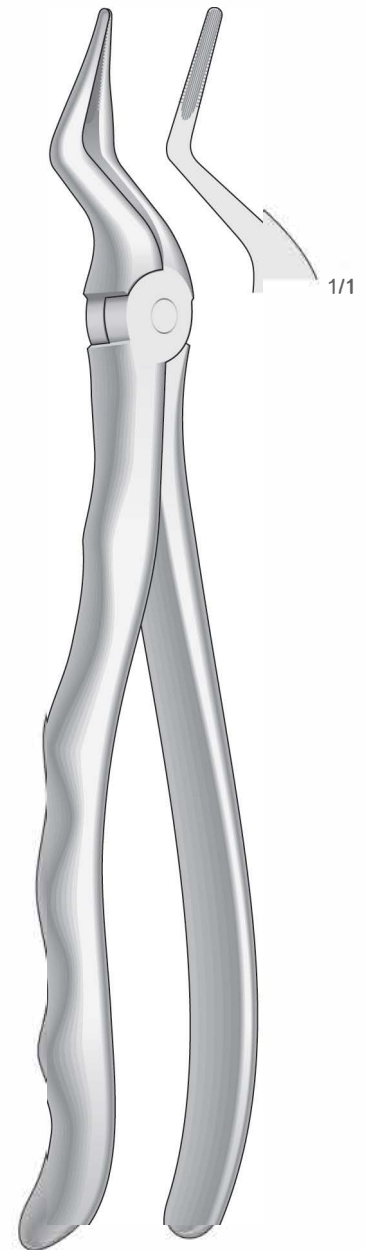

**SI-10051**  
Fig. 351S





Zahnzangen, Paßformgriff  
Extracting Forceps, Anatomical Handle  
Pinze per estrazione, Manico anatomico  
Pinzas da extracción, Mango anatómico  
Daviers, Manche anatomique

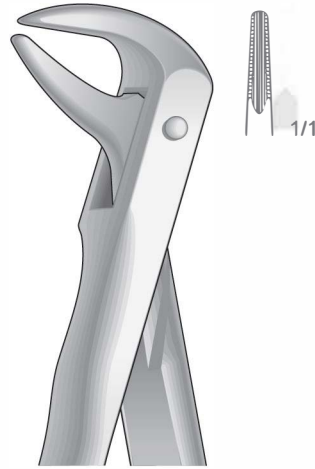

**SI-I0052**  
Fig. 74N

Untere Wurzeln Schneide- und Eckzähne  
Lower roots, incisors and cuspids  
Radici, incisivi e canini inferiori  
Raíces, incisivos y caninos inferiores  
Racines, incisives et canines inférieures



**SI-I0055**  
Fig. 74

Untere Wurzeln Schneide- und Eckzähne  
Lower roots, incisors and cuspids  
Radici, incisivi e canini inferiori  
Raíces, incisivos y caninos inferiores  
Racines, incisives et canines inférieures



**SI-I0053**  
Fig. 36

Untere Wurzeln Schneide- und Eckzähne  
Lower roots, incisors and cuspids  
Radici, incisivi e canini inferiori  
Raíces, incisivos y caninos inferiores  
Racines, incisives et canines inférieures

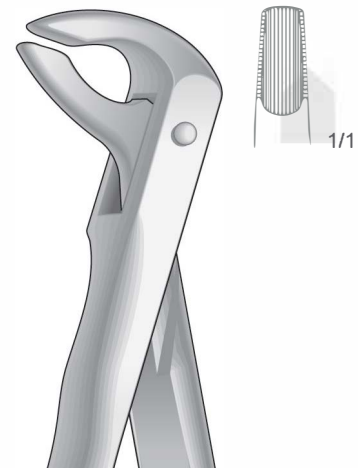

**SI-I0054**  
Fig. 36N

Untere Wurzeln Schneide- und Eckzähne  
Lower roots, incisors and cuspids  
Radici, incisivi e canini inferiori  
Raíces, incisivos y caninos inferiores  
Racines, incisives et canines inférieures



Zahnzangen, Paßformgriff  
Extracting Forceps, Anatomical Handle  
Pinze per estrazione, Manico anatomico  
Pinzas da extracción, Mango anatómico  
Daviers, Manche anatomique



**SI-I0056**  
Fig. 59

Untere Wurzelplitterzange  
Lower Root Fragments  
Frammenti e radici inferiori  
Fragmentos de raíces inferiores  
Fragments des racines inférieures



**SI-I0057**  
Fig. 86C

Untere Molaren mit kariösen oder abgebrochenen Kronen  
Lower molars with carious or broken caps  
Molari inferiori con corone cariate o spezzate  
Molares inferiores con coronas rotas o cariadas  
Molaires inférieures avec couronnes cariées ou cassées

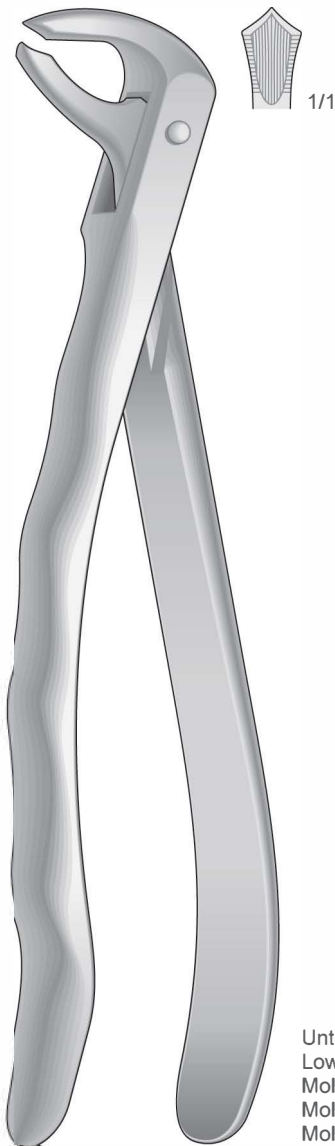

**SI-I0059**  
Fig. 73

Untere Molaren  
Lower molars  
Molari inferiori  
Molares inferiores  
Molaires inférieures



**SI-I0057A**  
Fig. 13

Untere Prämolaren und Eckzähne  
Lower premolars and cuspids  
Canini e premolari inferiori  
Caninos y premolares inferiores  
Canines et prémolaires inférieures



**SI-I0058**  
Fig. 22

Untere Molaren  
Lower molars  
Molari inferiori  
Molares inferiores  
Molaires inférieures



Zahnzangen, Paßformgriff  
Extracting Forceps, Anatomical Handle  
Pinze per estrazione, Manico anatomico  
Pinzas da extracción, Mango anatómico  
Daviers, Manche anatomique

Untere Weisheitszähne  
Lower wisdom teeth  
Denti del giudizio inferiori  
Muelas del juicio inferiores  
Dent de sagesse inférieures

Untere Prämolaren  
Lower premolars  
Premolari inferiori  
Premolares inferiores  
Prémolaires inférieures

Untere Molaren  
Lower Molars  
Molari inferiori  
Molares inferiores  
Molaires inférieures

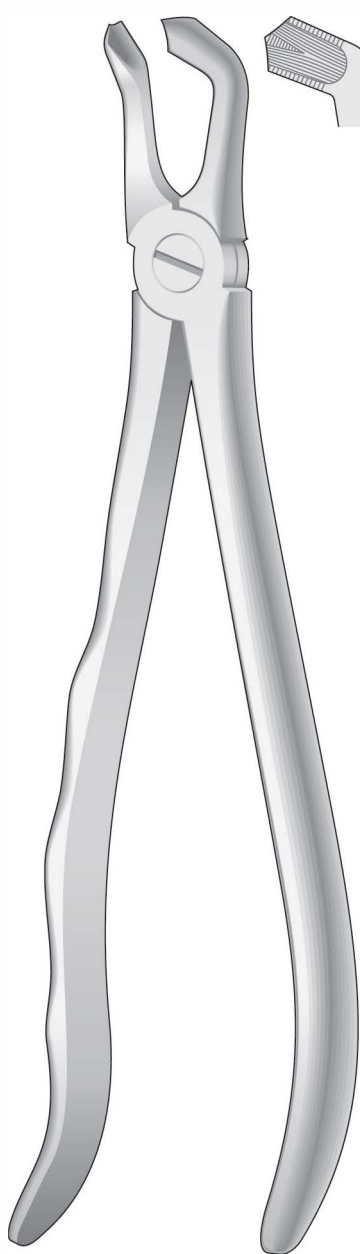

SI-I0060  
Fig. 79

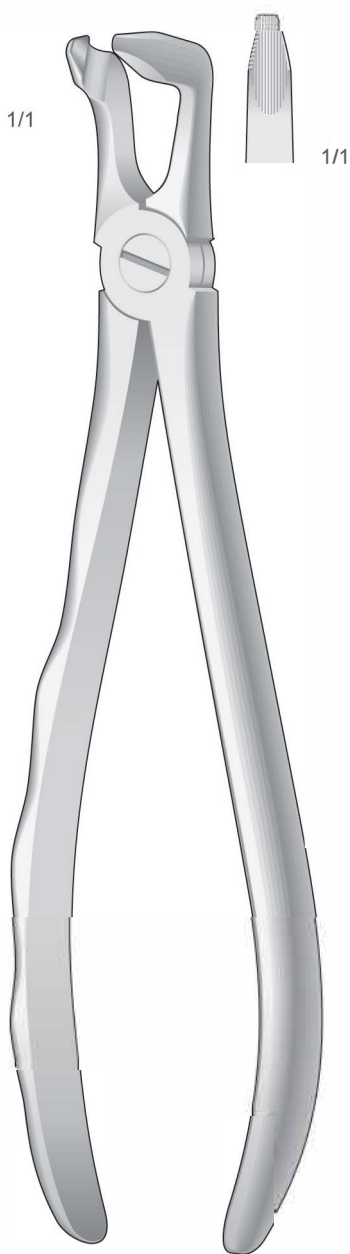

SI-I0061  
Fig. 79N

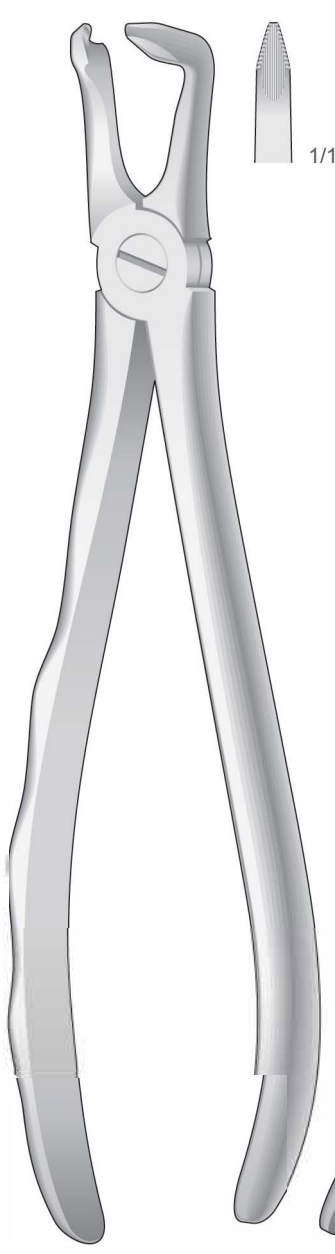

SI-I0062  
Fig. 46N



SI-I0063  
Fig. 87



Zahnzangen, Paßformgriff  
Extracting Forceps, Anatomical Handle  
Pinze per estrazione, Manico anatomico  
Pinzas da extracción, Mango anatómico  
Daviers, Manche anatomique



**SI-10064**  
Fig. 46LX



**SI-10065**  
Fig. 46L





Zahnzangen, Paßformgriff  
 Extracting Forceps, Anatomical Handle  
 Pinze per estrazione, Manico anatomico  
 Pinzas da extracción, Mango anatómico  
 Daviers, Manche anatomique

Untere Molaren und Weisheitszähne  
 Lower molars and wisdom teeth  
 Molari e denti del giudizio inferiori  
 Molares y muelas del juicio inferiores  
 Molaires et dent de sagesse inférieures

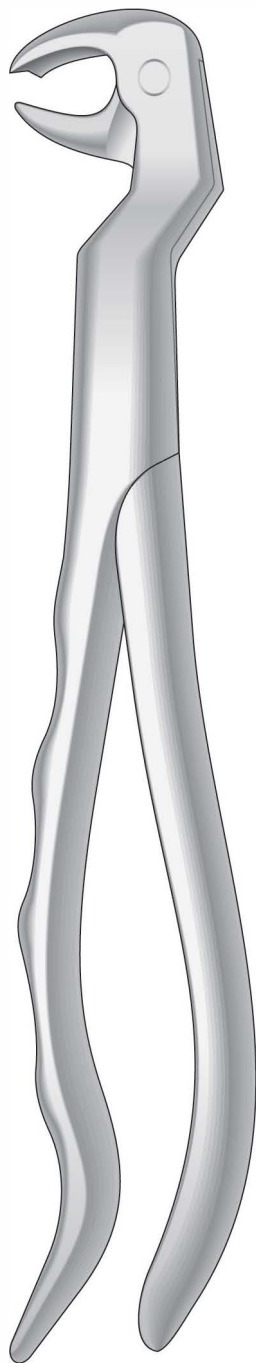

1/1

Links  
 Left  
 Sinistra  
 Izquierdos  
 Gauches

SI-I0065A

I-22 ½ L

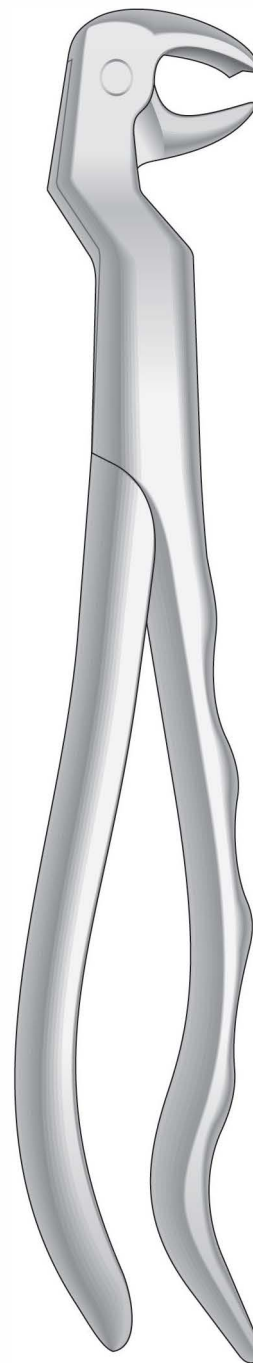

1/1

Rechts  
 Right  
 Destra  
 Derechos  
 Droites

SI-I0065B

I-22 ½ R



Zahnzangen, Anatomisches  
Extracting Forceps, Anatomical Handle  
Pinze per estrazione, Manico anatomico  
Pinzas da extracción, Mango anatómico  
Daviers, Manche anatomique

Untere Wurzeln sehr feine  
Lower very fine roots  
Radici inferiori molto sottili  
Raíces inferiores muy finas  
Racines inférieures très fines

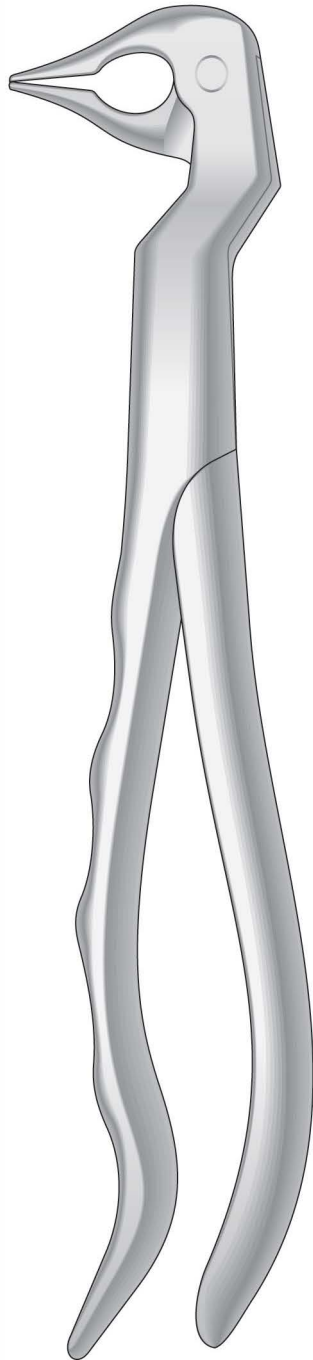

Links  
Left  
Sinistra  
Izquierdos  
Gauches

SI-10066  
Fig.133

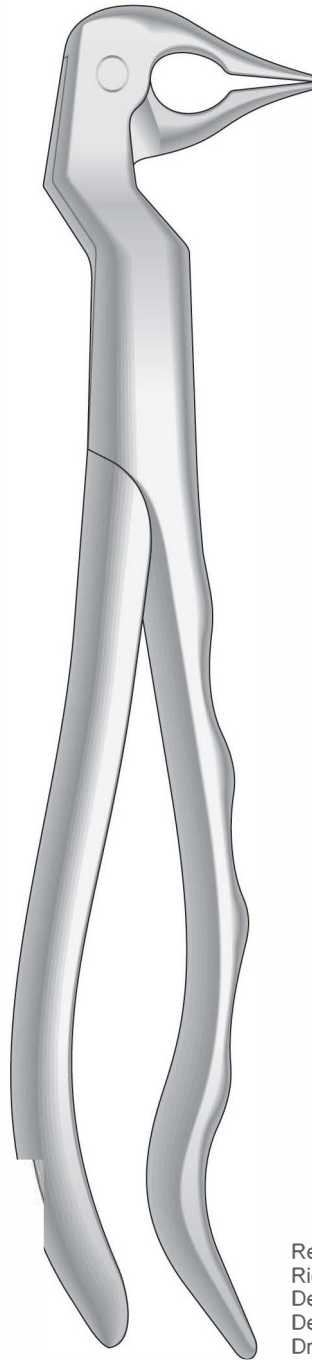

Rechts  
Right  
Destra  
Derechos  
Droites

SI-10067  
Fig.133



SI-10068  
Fig.333S



Zahnzangen, Amerikanische Form  
Extracting Forceps, American Pattern  
Pinze per estrazione, Forma Americana  
Pinzas da extracción, Forma Americana  
Daviers, Forme Américaine



**SI-10072**  
Fig. 1

Obere Schneide- und Eckzähne  
Upper incisors and cuspids  
Incisivi e canini superiori  
Incisivos y caninos superiores  
Incisives et canines supérieures

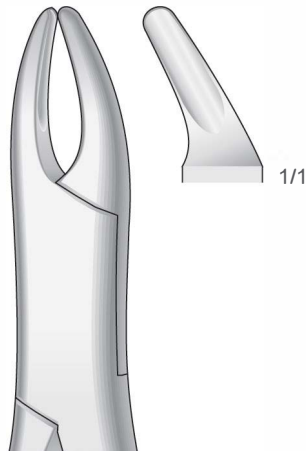

**CRYER**  
**SI-10069**  
Fig. 150

Obere Prämolaren, Schneidezähne, Wurzeln  
Upper Bicuspid, incisors and roots  
Premolari, incisivi e radici superiori  
Premolares, incisivos y raíces superiores  
Prémolaires, incisives et racines supérieures

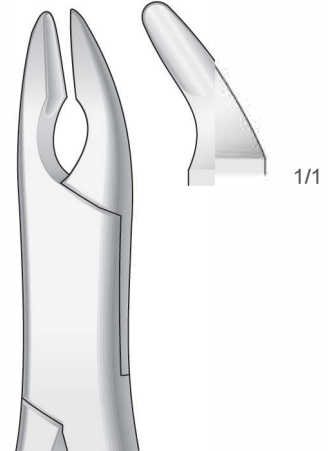

**CRYER**  
**SI-10070**  
Fig. 150A

Obere Prämolaren, Schneidezähne, Wurzeln  
Upper Bicuspid, incisors and roots  
Premolari, incisivi e radici superiori  
Premolares, incisivos y raíces superiores  
Prémolaires, incisives et racines supérieures



**SI-10071**  
Fig. 62

Schneidezähne, Prämolaren, Milchzähne  
Incisors, premolars, deciduous teeth  
Incisivi, premolari, denti da latte  
Incisivos, premolares, dientes de leche  
Incisives, prémolaires, dents de lait



Zahnzangen, Amerikanische Form  
Extracting Forceps, American Pattern  
Pinze per estrazione, Forma Americana  
Pinzas da extracción, Forma Americana  
Daviers, Forme Américaine



**SI-10076**  
Fig. 53R

Obere Molaren, Rechts  
Upper Molars, Right  
Molari superiori, Destra  
Molares superiores, Derechos  
Molaires supérieures, Droites

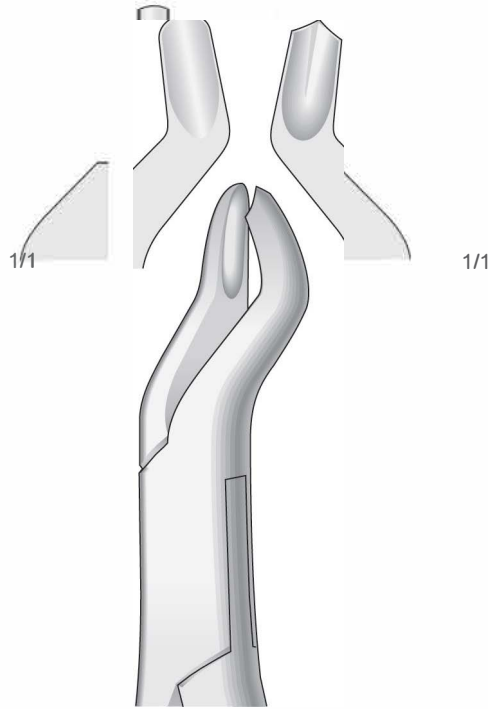

**SI-10073**  
Fig. 53L

Obere Molaren, Links  
Upper Molars, Left  
Molari superiori, Sinistra  
Molares superiores, Izquierdos  
Molaires supérieures, Gauches

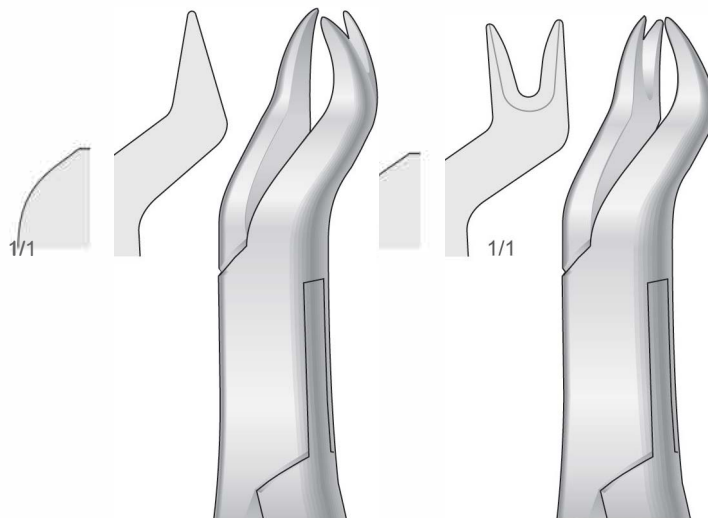

**NEVIUS**  
**SI-10074**  
Fig. 88R

Obere Molaren, Rechts  
Upper Molars, Right  
Molari superiori, Destra  
Molares superiores, Derechos  
Molaires supérieures, Droites

**NEVIUS**  
**SI-10075**  
Fig. 88L

Obere Molaren, Links  
Upper Molars, Left  
Molari superiori, Sinistra  
Molares superiores, Izquierdos  
Molaires supérieures, Gauches





Zahnzangen, Amerikanische Form  
Extracting Forceps, American Pattern  
Pinze per estrazione, Forma Americana  
Pinzas da extracción, Forma Americana  
Daviers, Forme Américaine

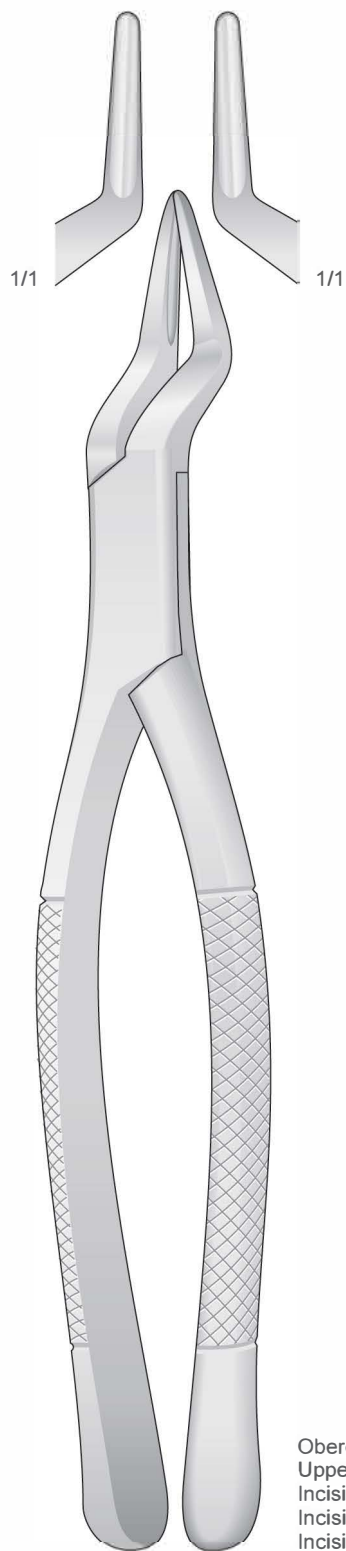

**SI-10079**  
Fig.65

Obere Schneidezähne und Wurzeln  
Upper Incisors and Roots  
Incisivi e radici superiori  
Incisivos y raices superiores  
Incisives et racines supérieures

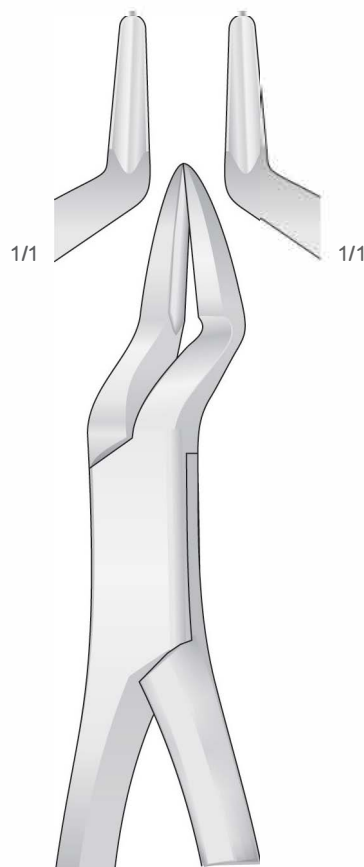

**PARMLY**  
**SI-10077**  
Fig. 32A

Obere Wurzeln und Prämolaren  
Upper Roots and Premolars  
Radici e premolari superiori  
Raices y premolares superiores  
Racines et prémolaires supérieures

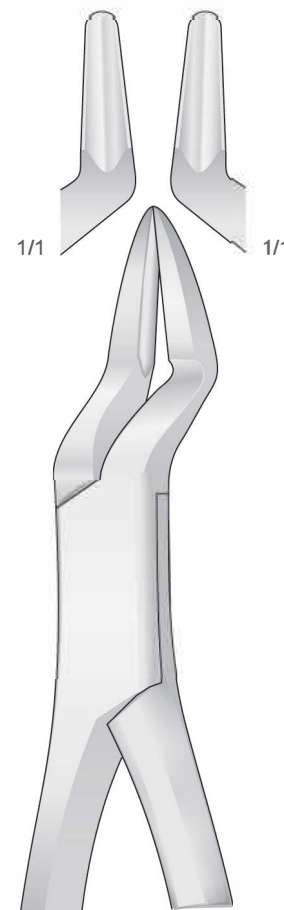

**PARMLY**  
**SI-10078**  
Fig. 32

Obere Prämolaren und Molaren  
Upper Premolars and Molars  
Premolari e molari superiori  
Premolares y Molares superiores  
Prémolaires et Molaires supérieures



Zahnzangen, Amerikanische Form  
Extracting Forceps, American Pattern  
Pinze per estrazione, Forma Americana  
Pinzas da extracción, Forma Americana  
Daviers, Forme Américaine

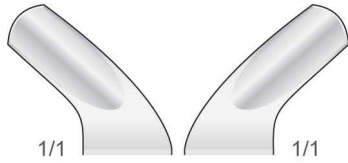

**SI-10082**  
Fig. 24

Obere Molaren  
Upper Molars  
Molari superiori  
Molares superiores  
Molaires supérieures

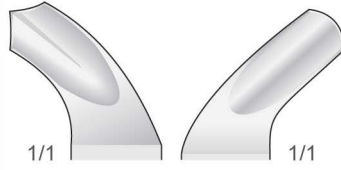

**HARRIS**  
**SI-10080**  
Fig. 18R

Obere Molaren, Rechts  
Upper Molars, Right  
Molari superiori, Destra  
Molares superiores, Derechos  
Molaires supérieures, Droites

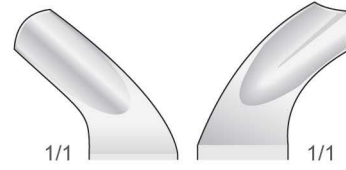

**HARRIS**  
**SI-10081**  
Fig. 18L

Obere Molaren, Links  
Upper Molars, Left  
Molari superiori, Sinistra  
Molares superiores, Isquierdos  
Molaires supérieures, Gauches

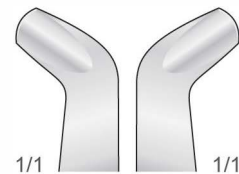

**SI-10083**  
Fig. 210

Obere Molaren  
Upper Molars  
Molari superiori  
Molares superiores  
Molaires supérieures



Zahnzangen, Amerikanische Form  
Extracting Forceps, American Pattern  
Pinze per estrazione, Forma Americana  
Pinzas da extracción, Forma Americana  
Daviers, Forme Américaine

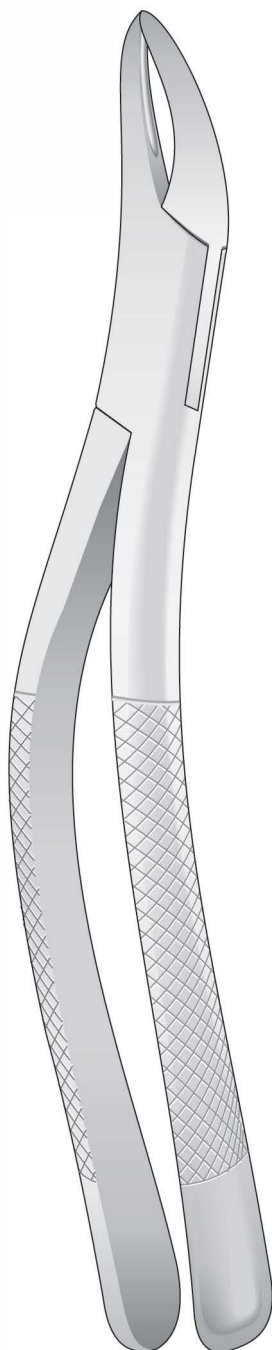
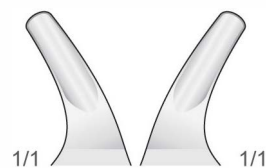
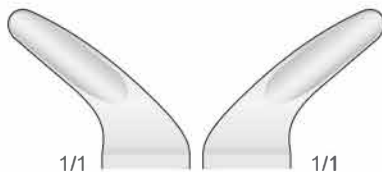
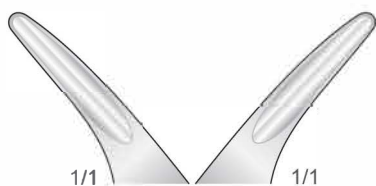

Obere und Untere  
Upper and lower  
Superiori e inferiori  
Superiores y inferiores  
Supérieures et inférieures

Wurzeln  
Roots  
Radici  
Raíces  
Racines

**TOMES**  
**SI-10084**  
Fig.69

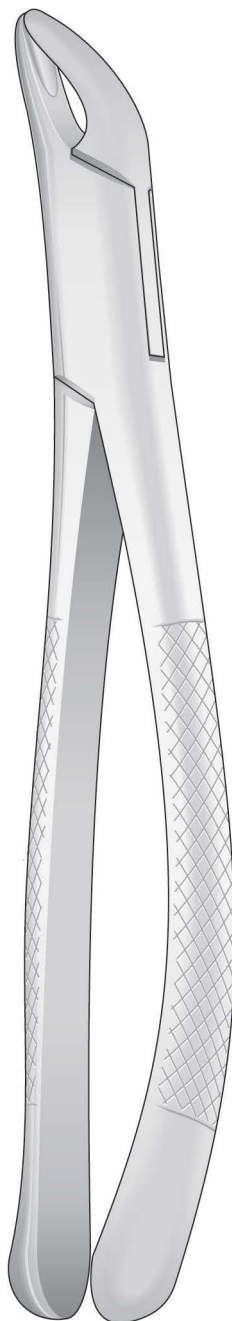

Untere  
Lower  
Inferiori  
Inferiores  
Inférieures

Schneidezähne, Prämolaren, Wurzeln  
Incisors, Premolars, Roots  
Incisivi, premolari, radici  
Incisivos, premolares, raíces  
Incisives, prémolaires, racines

**CRYER**  
**SI-10085**  
Fig.151



**HULL**  
**SI-10086**  
Fig. 101

Für Eckzähne und Prämolaren,  
Universalzange und Kinderzange  
For canines and Premolars,  
Universal and Tooth forceps for children  
Canini e premolari,  
universale e per bambini  
Caninos y premolares,  
universal y para niños  
Canines et prémolaires,  
universel et pour enfants



Zahnzangen, Amerikanische Form  
Extracting Forceps, American Pattern  
Pinze per estrazione, Forma Americana  
Pinzas da extracción, Forma Americana  
Daviers, Forme Américaine

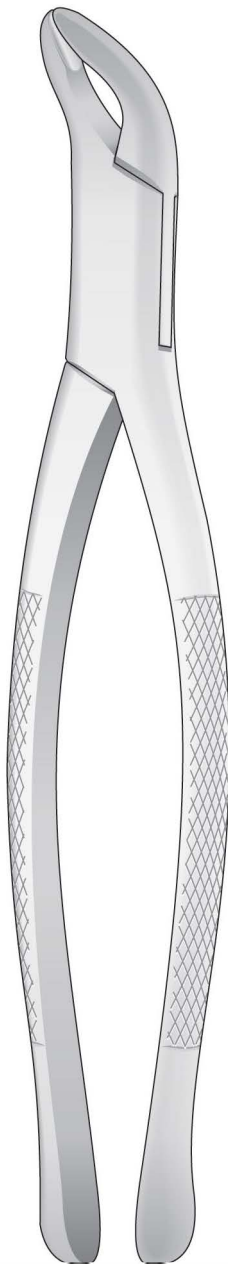

**SI-10089**  
Fig. 203

Untere Schneidezähne, Prämolaren, Wurzeln  
Lower Incisors, Premolars, Roots  
Incisivi, premolari, radici inferiori  
Incisivos, premolares, raices inferiores  
Incisives, prémolaires, racines inférieures

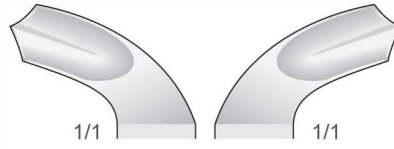

**SI-10087**  
Fig. 17

Untere Molaren  
Lower Molars  
Molari inferiori  
Molares inferiores  
Molaires inférieures

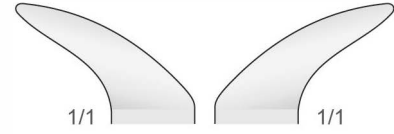

**SI-10088**  
Fig. 23

Untere Molaren  
Lower Molars  
Molari inferiori  
Molares inferiores  
Molaires inférieures





Zahnzangen, Amerikanische Form  
Extracting Forceps, American Pattern  
Pinze per estrazione, Forma Americana  
Pinzas da extracción, Forma Americana  
Daviers, Forme Américaine

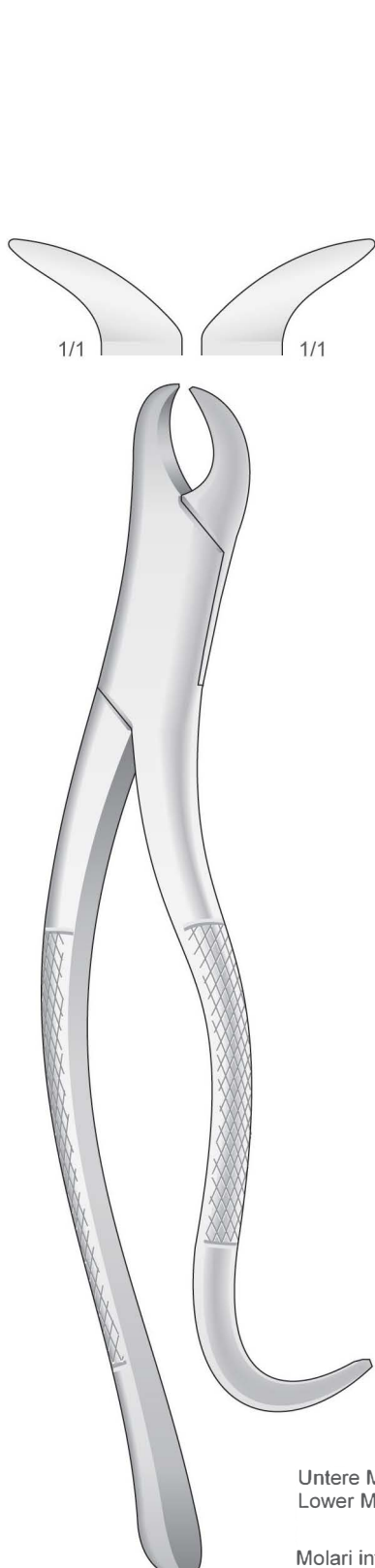

**SI-10092**

0  
Fig.  
16

Untere Molaren  
Lower Molars

Molari inferiori  
Molares inferiores  
Molaires inféneures

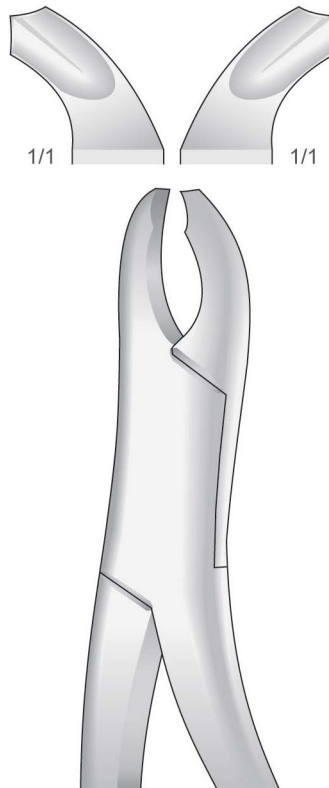

**HARRIS**  
**SI-1090**

Fig  
Untere Molaren  
Lower Molars  
Molari inferiori

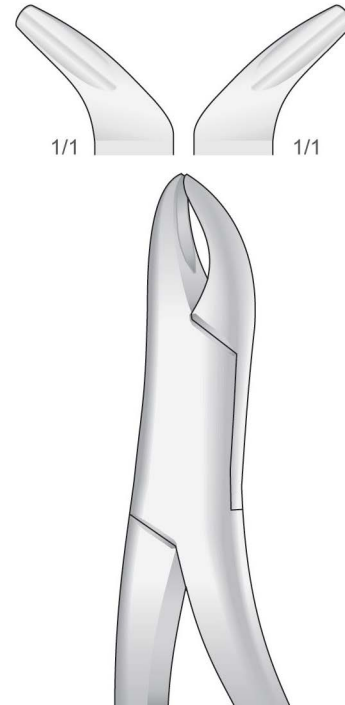

**SI-10091**  
Fig. 103



Zahnzangen, Amerikanische Form  
Extracting Forceps, American Pattern  
Pinze per estrazione, Forma Americana  
Pinzas da extracción, Forma Americana  
Daviers, Forme Américaine

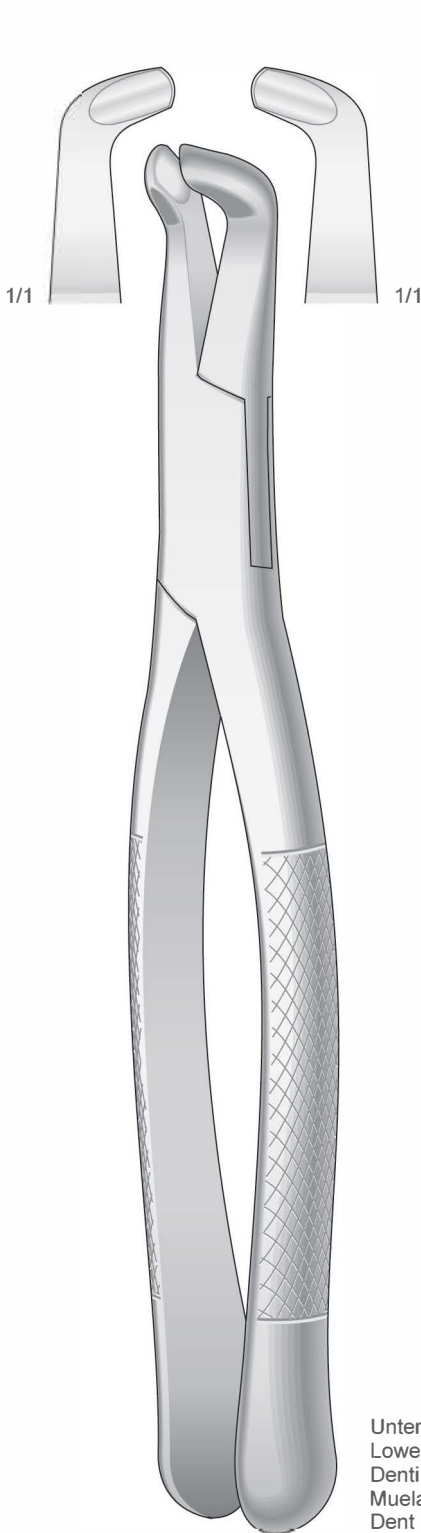

**SI-10094**  
Fig. 222

Untere Weisheitszähne  
Lower wisdom teeth  
Denti del giudizio inferiori  
Muelas del juicio inferiores  
Dent de sagesse inférieures

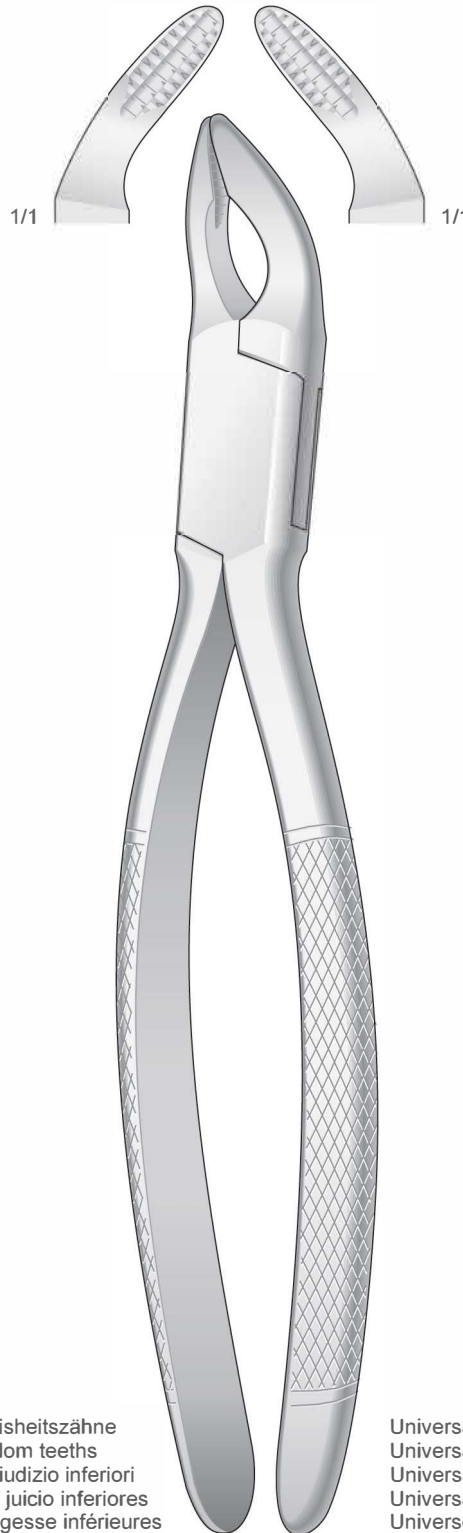

**COHEN**  
**SI-10095**

Universal  
Universal  
Universale  
Universal  
Universeel

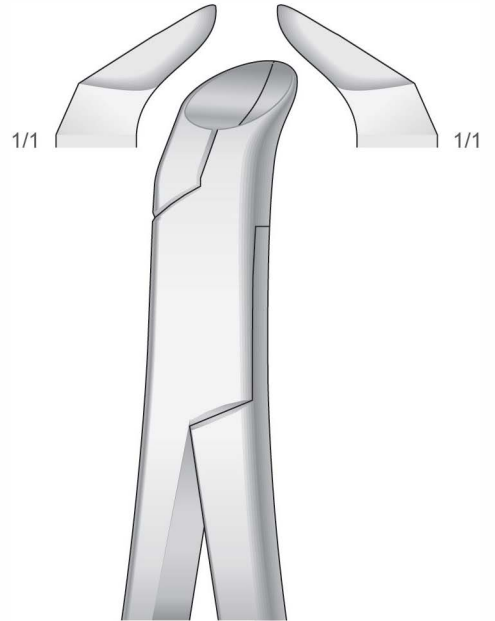

**PHYSICK**  
**SI-10093**  
Fig. 5

Untere Weisheitszähne  
Lower wisdom teeth  
Denti del giudizio inferiori  
Muelas del juicio inferiores  
Dent de sagesse inférieures



Zahnzangen, Amerikanische Form  
Extracting Forceps, American Pattern  
Pinze per estrazione, Forma Americana  
Pinzas da extracción, Forma Americana  
Daviers, Forme Américaine

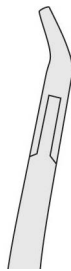
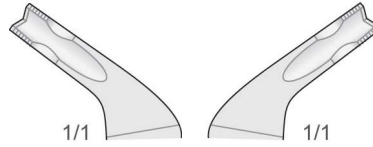
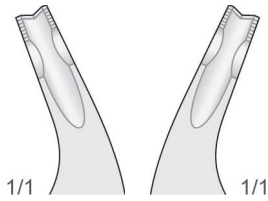

Obere  
Upper  
Superiori  
Superiores  
Supérieures

Prämolaren, Schneidezähne und Wurzeln  
Bicuspid, incisors and roots  
Premolari, incisivi e radici  
Premolares, incisivos y raíces  
Premolaires, incisives et racines

**SI-10096**  
Fig. 150AS



Untere  
Lower  
Inferiori  
Inferiores  
Inférieures

Prämolaren, Schneidezähne und Wurzeln  
Bicuspid, incisors and roots  
Premolari, incisivi e radici  
Premolares, incisivos y raíces  
Premolaires, incisives et racines

**SI-10097**  
Fig. 151AS



Zahnzangen, Amerikanische Form  
Extracting Forceps, American Pattern  
Pinze per estrazione, Forma Americana  
Pinzas da extracción, Forma Americana  
Daviers, Forme Américaine

Für Kinder  
For children  
Per bambini  
Para niños  
Pour enfants

Obere - Upper  
Superiori - Superiores  
Supérieures

Untere - Lower  
Inferiori - Inferiores  
Inférieures

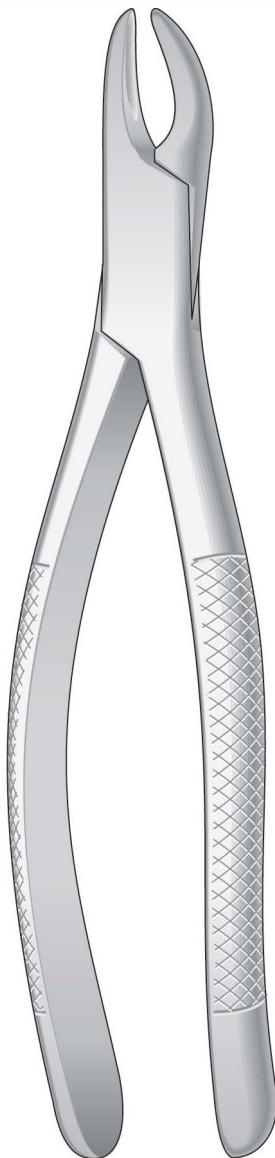
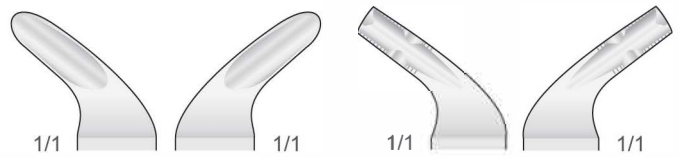
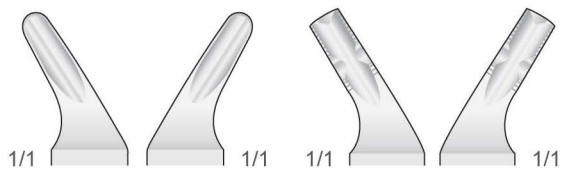

CRYER  
**SI-10098**  
Fig.150 S



**SI-10099**  
Fig.150 XAS

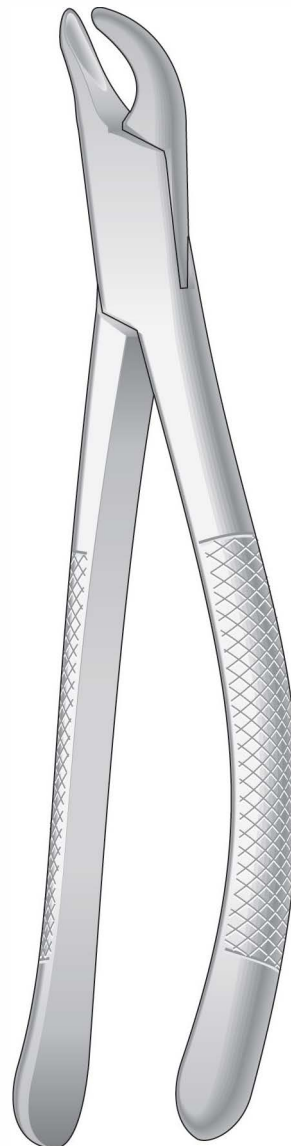

CRYER  
**SI-10100**  
Fig.151 S



**SI-10101**  
Fig.151 XAS



Zahnzangen, Amerikanische Form  
 Extracting Forceps, American Pattern  
 Pinze per estrazione, Forma Americana  
 Pinzas da extracción, Forma Americana  
 Daviers, Forme Américaine

Geriefte - Serrated - Striata - Estriadas - Striées

Obere Schneidezähne, Prämolaren, Wurzeln  
 Upper incisors, premolars, roots  
 Incisivi, premolari e radici superiori  
 Incisivos, premolares y raíces superiores  
 Incisives, prémolaires et racines supérieures

Untere Schneidezähne, Prämolaren, Wurzeln  
 Lower incisors, premolars, roots  
 Incisivi, premolari e radici inferiori  
 Incisivos, premolares y raíces inferiores  
 Incisives, prémolaires et racines inférieures

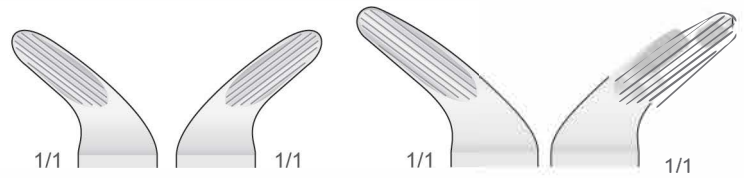
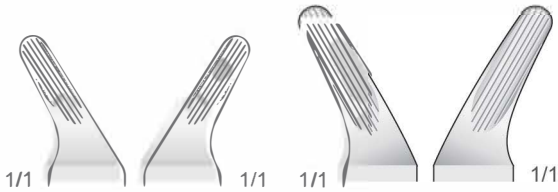

CRYER  
**SI-10102**  
 Fig. 150

Für Erwachsene  
 For adults  
 Per adulti  
 Para adultos  
 Pour adults

Für Kinder  
 For children  
 Per bambini  
 Para niños  
 Pour enfants

CRYER  
**SI-10104**  
 Fig.150 S



CRYER  
**SI-10103**  
 Fig. 151

Für Erwachsene  
 For adults  
 Per adulti  
 Para adultos  
 Pour adults

Für Kinder  
 For children  
 Per bambini  
 Para niños  
 Pour enfants

CRYER  
**SI-10105**  
 Fig.151 S





Zahnzangen  
Extracting Forceps  
Pinze per estrazione  
Pinzas da extracción  
Daviers

Schneidezähne, Eckzähne, Wurzeln  
Incisors, bicuspid and roots  
Incisivi, canini e radici  
Incisivos, caninos y raíces  
Incisives, canines et racines

Molaren  
Molars  
Molari  
Molares  
Molaires

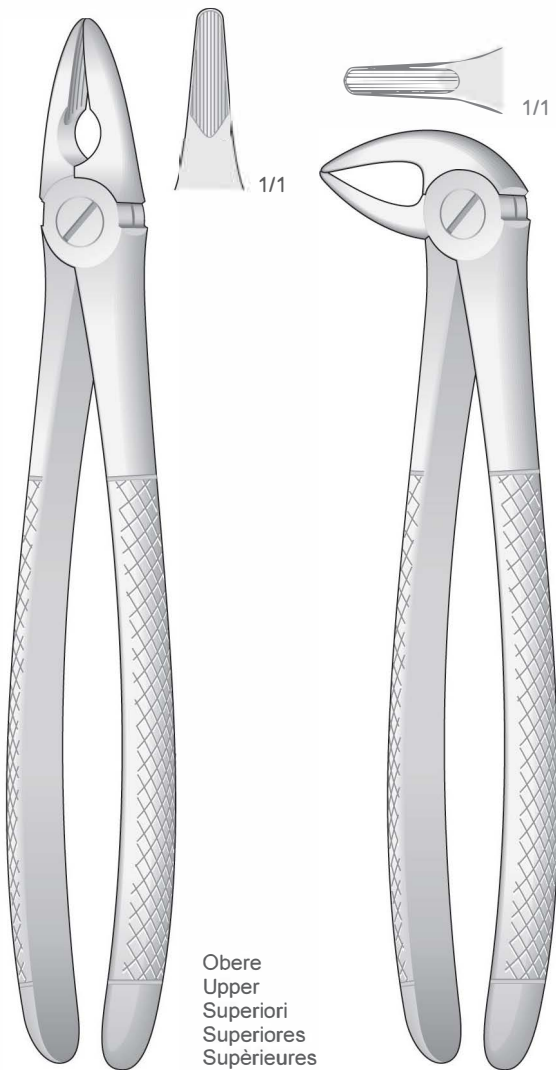

Obere  
Upper  
Superiori  
Superiores  
Supérieures

Untere  
Lower  
Inferiori  
Inferiores  
Inférieures

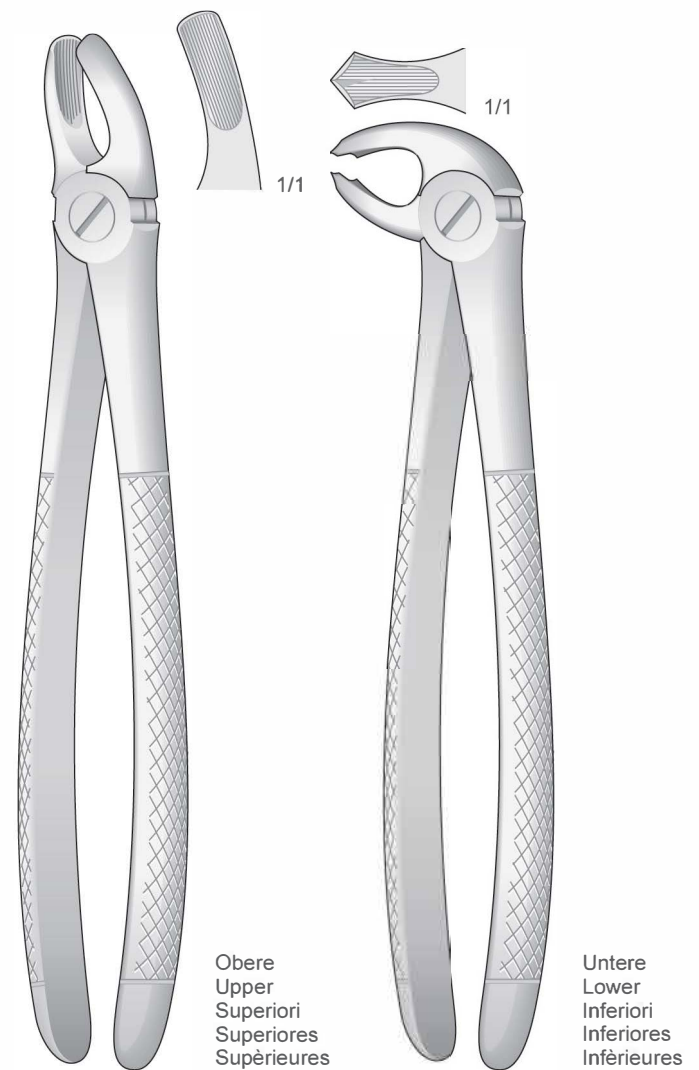

Obere  
Upper  
Superiori  
Superiores  
Supérieures

Untere  
Lower  
Inferiori  
Inferiores  
Inférieures

SI-10106  
MD-1

SI-10107  
MD-3

SI-10108  
MD-2

SI-10109  
MD-4



Kinderzahnzangen, Amerikanische Form  
Extracting Forceps for children, American Pattern  
Pinze per estrazione per bambini, Forma Americana  
Forceps dentales para niños, Forma Americana  
Daviers pour enfants, Forme Américaine

Molaren  
Pedo Lower Molars  
Molari  
Molares  
Molaires

Molaren  
Pedo Lower Molars  
Molari  
Molares  
Molaires

Zähne und wurzeln  
Pedo upper incisors  
Bicuspid and roots  
Denti e radici  
Dientes y raíces  
Dentes et racines

Zähne und wurzeln  
Pedo lower incisors  
Bicuspid and roots  
Denti e radici  
Dientes y raíces  
Dentes et racines

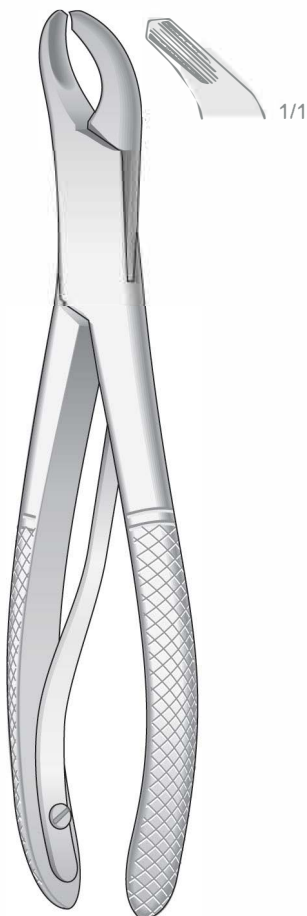

**SI-10110**  
Fig. 17SK

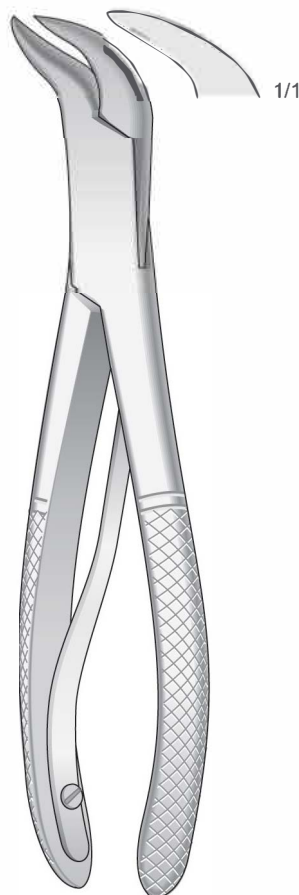

**SI-10111**  
Fig. 23SK

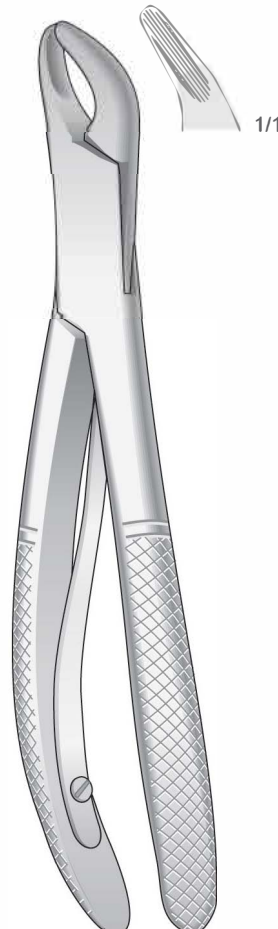

**SI-10112**  
Fig. 150SK

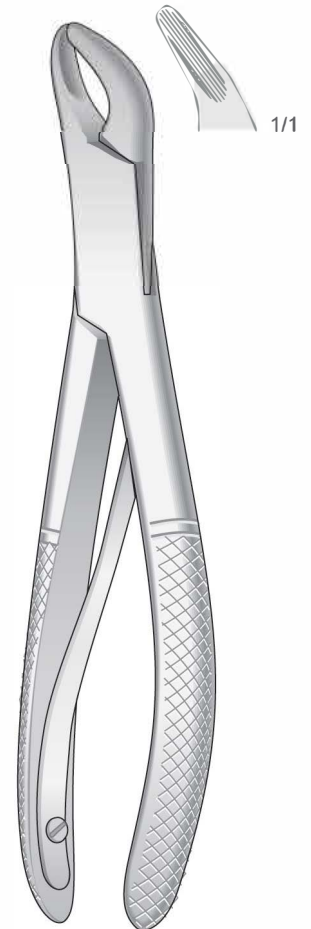

**SI-10113**  
Fig. 151SK



Kinderzahnzangen  
Extracting Forceps for children  
Pinze per estrazione per bambini  
Forceps dentales para niños  
Daviers pour enfants

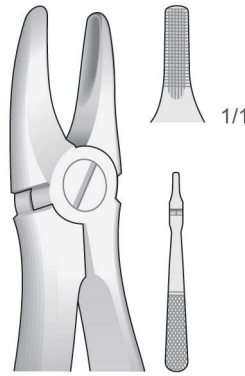

**SI-10114A**  
Fig. 137

Obere Schneidezähne  
Upper Incisors  
Incisivi superiori  
Incisivos superiores  
Incisives supérieures

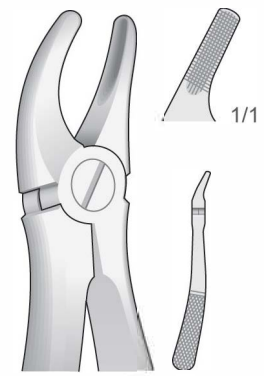

**SI-10115**  
Fig. 139

Obere Prämolaren  
Upper Premolars  
Premolari superiori  
Premolares superiores  
Prémolaires supérieures

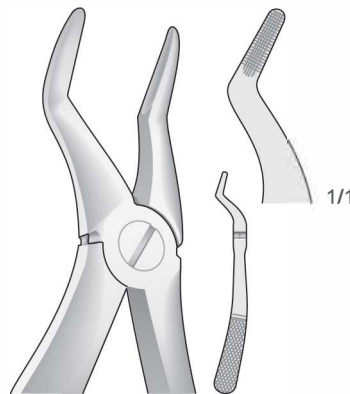

**SI-10116**  
Fig. 51S

Obere Wurzeln  
Upper roots  
Radici superiori  
Raíces superiores  
Racines supérieures

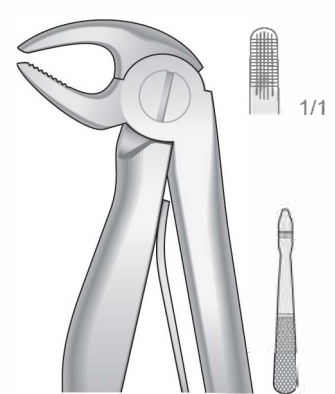

**SI-10117**  
Fig. 5

Untere Schneidezähne  
Lower incisors  
Incisivi inferiori  
Incisivos inferiores  
Incisives inférieures

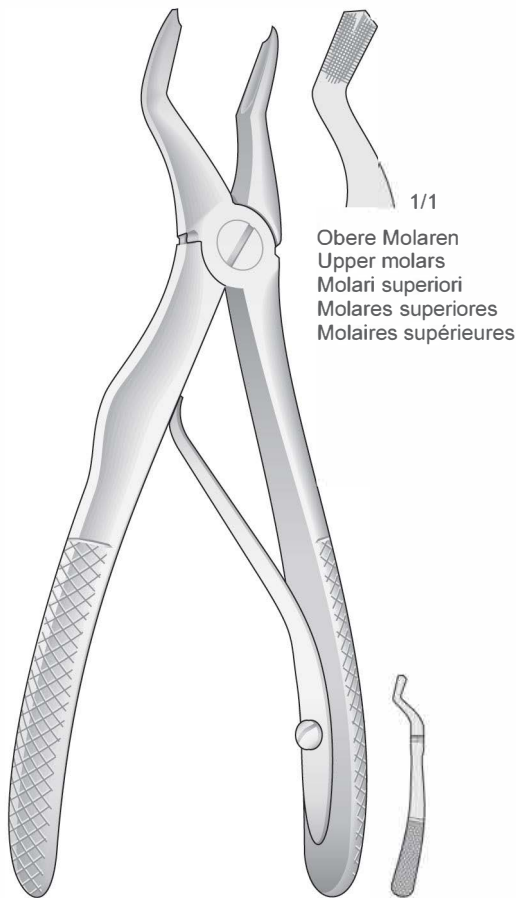

**SI-10114**  
**PEB-3**



**SI-10118**  
Fig. 6

Untere Molaren  
Lower molars  
Molari inferiori  
Molares inferiores  
Molaires inférieures

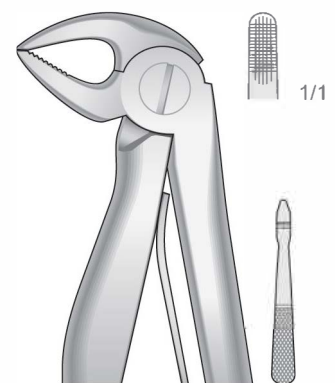

**SI-10119**  
Fig. 7

Untere Wurzeln  
Lower roots  
Radici inferiori  
Raíces inferiores  
Racines inférieures



Zahnzangen  
Extracting Forceps  
Pinze per estrazione  
Pinzas da extracción  
Daviers

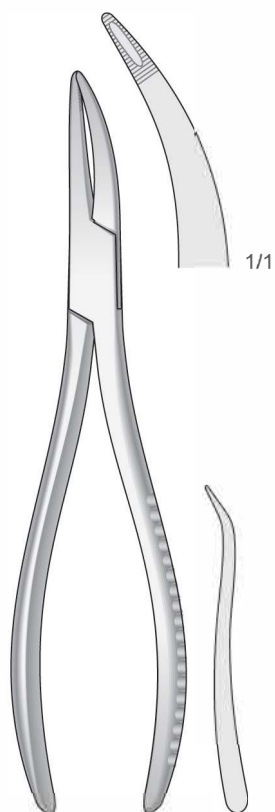

Obere Wurzeln, Universal  
Upper roots, Universal  
Radici superiori, Universale  
Raíces superiores, Universal  
Racines superieures, Universel

**WITZEL**  
**SI-10120**  
170 mm

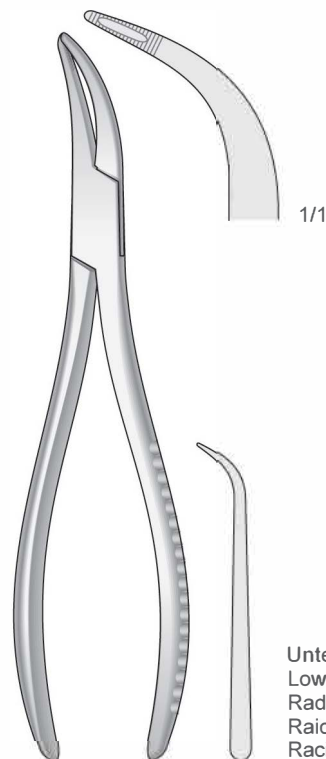

Untere Wurzeln, Universal  
Lower roots, Universal  
Radici inferiori, Universale  
Raíces inferiores, Universal  
Racines inferieures, Universel

**WITZEL**  
**SI-10121**  
165 mm

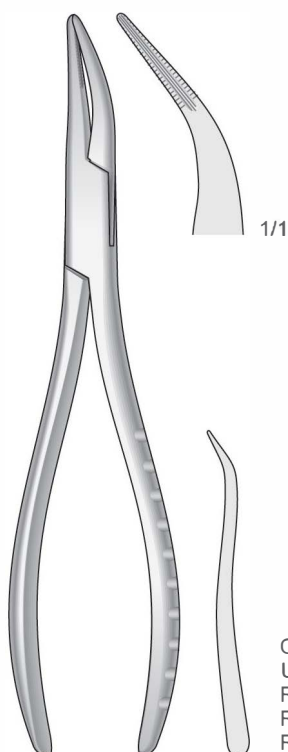

Obere Wurzeln, Universal  
Upper roots, Universal  
Radici superiori, Universale  
Raíces superiores, Universal  
Racines superieures, Universel

**SI-10122**  
165 mm

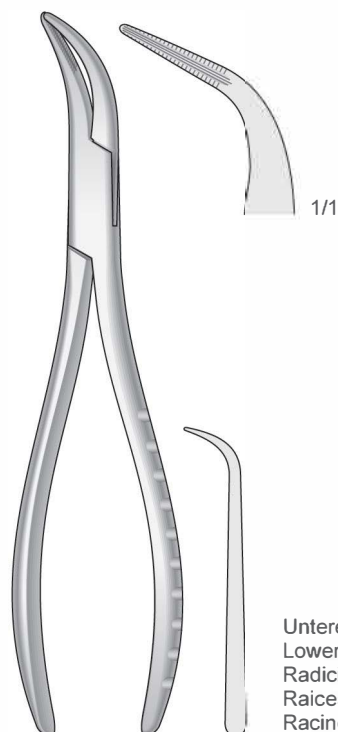

Untere Wurzeln, Universal  
Lower roots, Universal  
Radici inferiori, Universale  
Raíces inferiores, Universal  
Racines inferieures, Universel

**SI-10123**  
160 mm



Wurzelheber  
 Root Elevators  
 Leve per radici  
 Elevadores para raíces  
 Elevateurs à racines

## SMALL HANDLE

Luxatoren - Luxators  
 Lussatori - Luxadores  
 Luxateurs

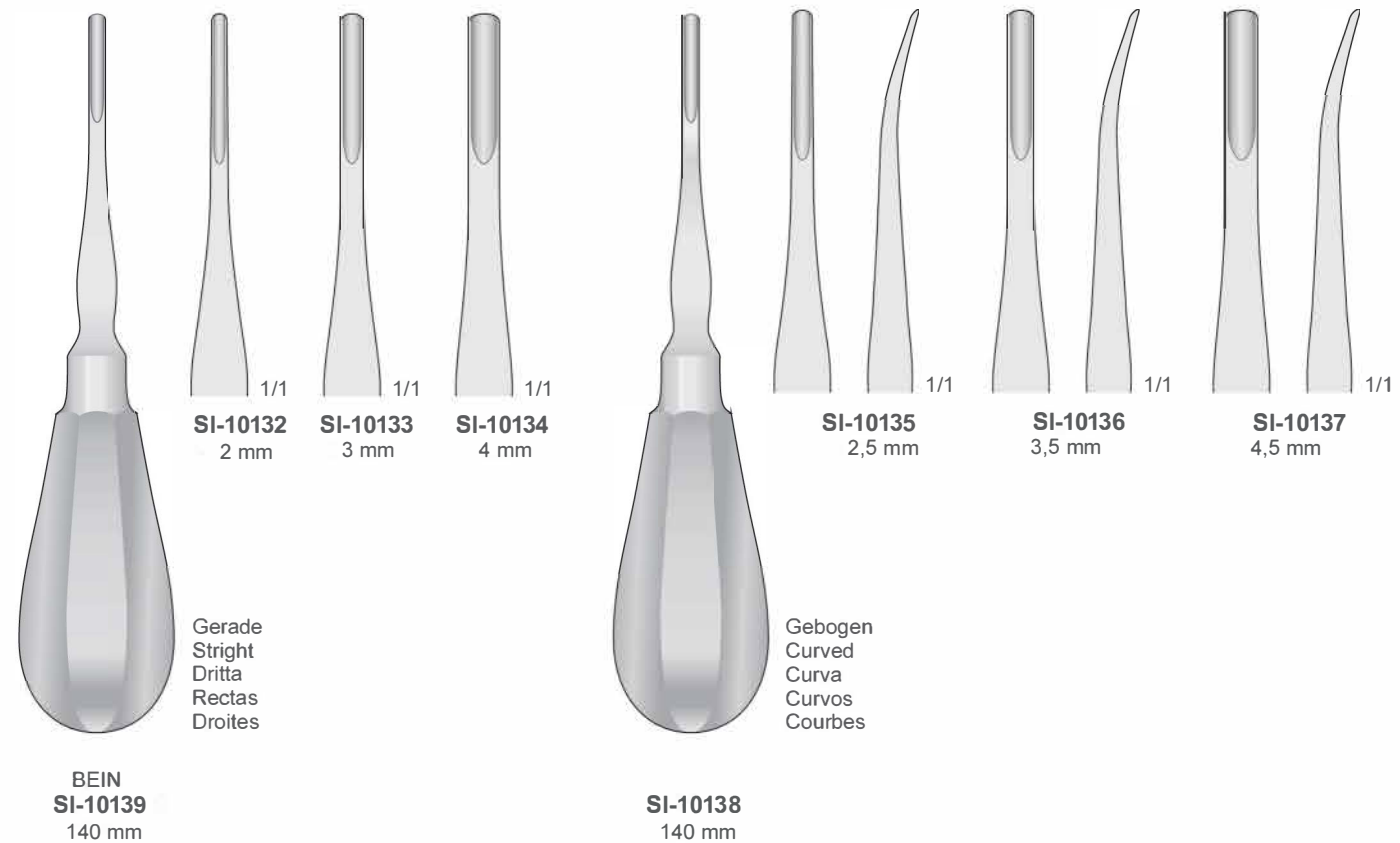
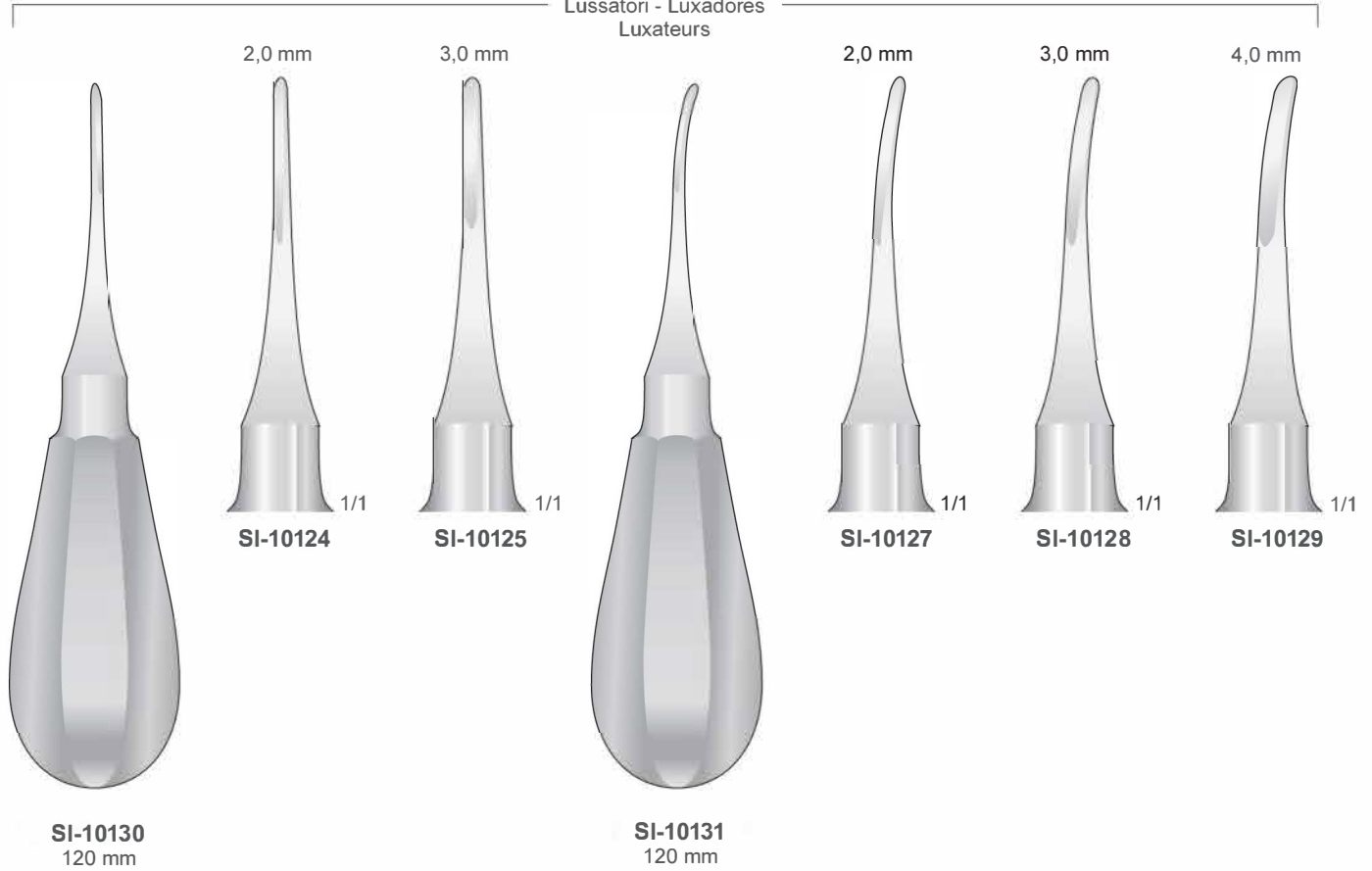





Wurzelheber  
Root Elevators  
Leve per radici  
Elevadores para raíces  
Elevateurs à racines

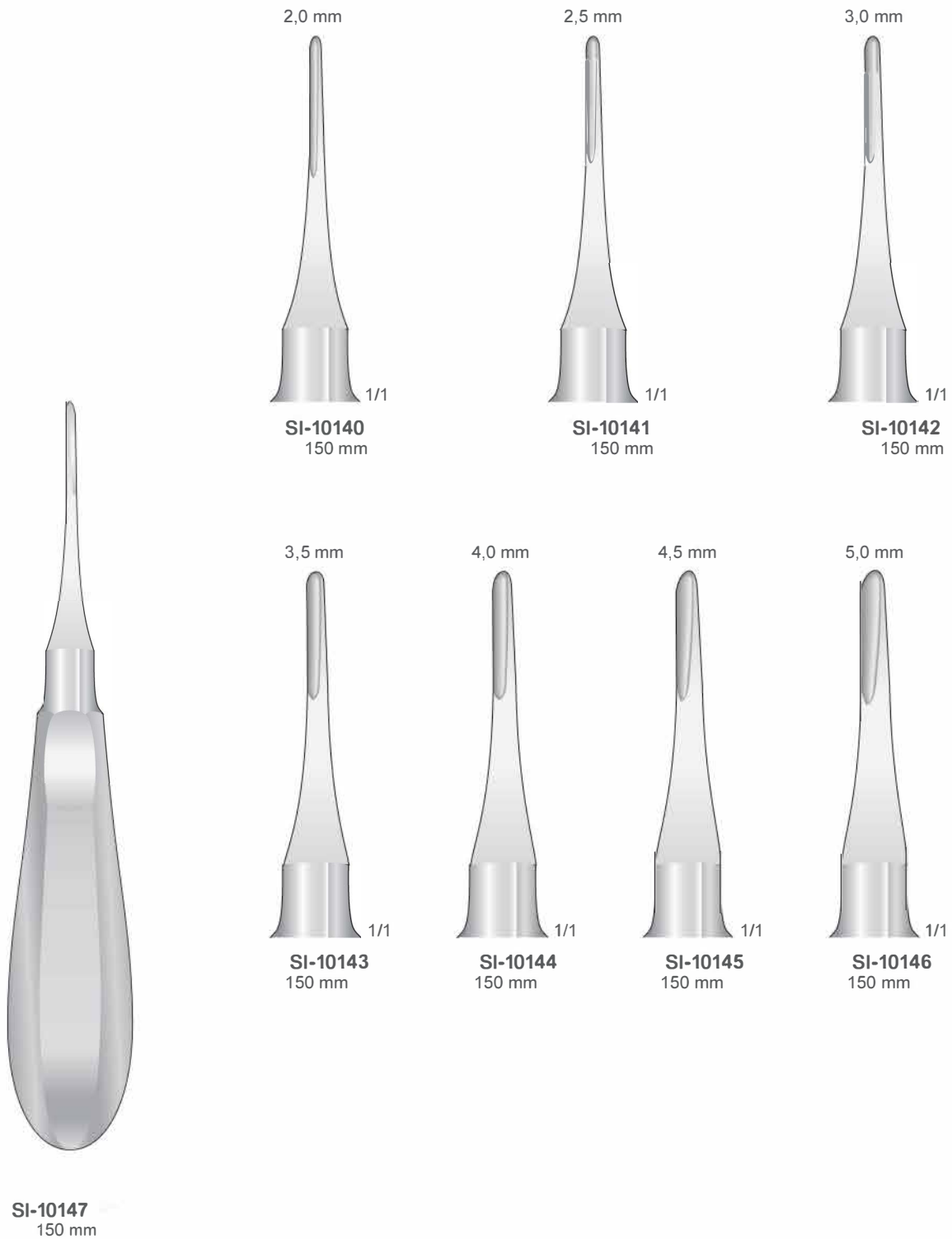



Wurzelheber  
Root Elevators  
Leve per radici  
Elevadores para raíces  
Elevateurs à racines

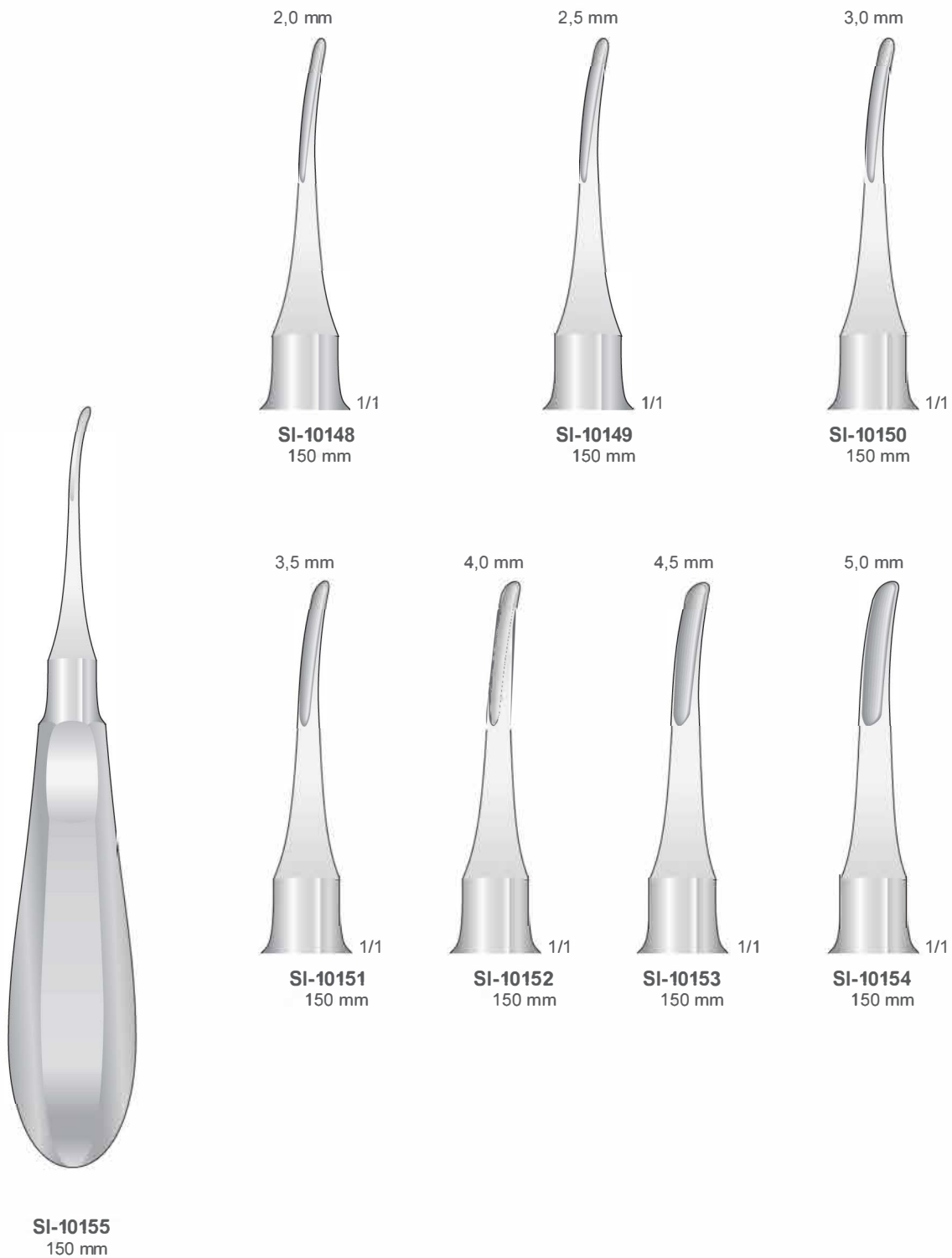



Wurzelheber  
Root Elevators  
Leve per radici  
Elevadores para raíces  
Elevateurs à racines

Luxatoren  
Luxators  
Lussatori  
Luxadores  
Luxateurs

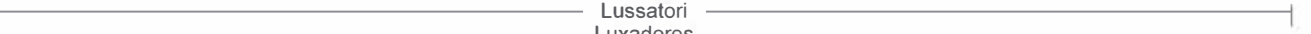

**SI-10156**  
150 mm



**SI-10157**  
150 mm

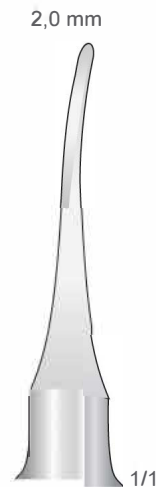

**SI-10 158**  
50 mm



**SI-10159**  
150 mm



**SI-101364**  
150 mm



**SI-10160**  
150 mm

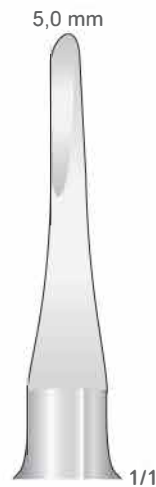

**SI-10161**  
150 mm



**SI-10165**  
150 mm

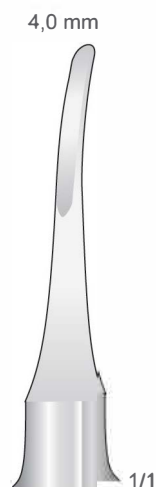

**SI-10162**  
150 mm



**SI-10163**  
150 mm



Wurzelheber  
Root Elevators  
Leve per radici  
Elevadores para raíces  
Elevateurs à racines

Wurzelspitzenheber  
Root fragment Elevators  
Leve per frammenti di radice  
Elevadores para fragmentos de raíces  
Elévateurs de fragments de racines

Gezahnt  
Serrated  
Dentellata  
Dentada  
Dentelé



**HEIDBRINK  
SI-10166**  
140 mm



**HEIDBRINK  
SI-10167**  
140 mm



**HEIDBRINK  
SI-10168**  
140 mm

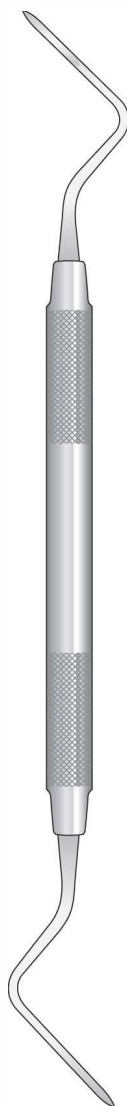

**HEIDBRINK  
SI-10169**  
195 mm

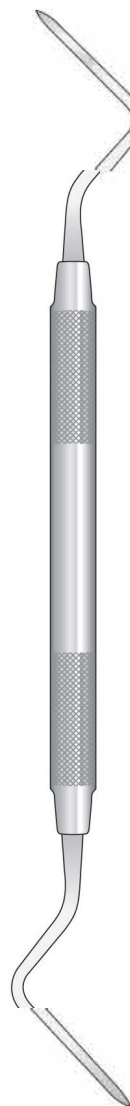

**HEIDBRINK  
SI-10170**  
195 mm

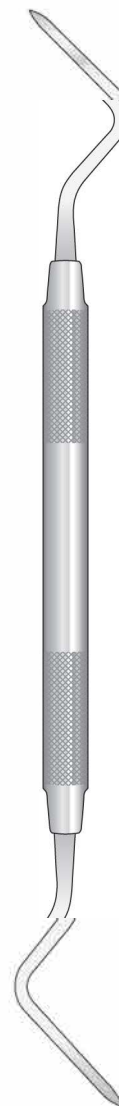

**HEIDBRINK  
SI-10171**  
195 mm



**HEIDBRINK  
SI-10172**  
195 mm



Wurzelheber  
Root Elevators  
Leve per radici  
Elevadores para raíces  
Elevateurs à racines

Extraktionshebel für obere Weisheitszähne  
Luxator for upper wisdom teeth  
Leva per estrazione dente del giudizio superiore  
Elevador de extracción de muelas del juicio superiores  
Levier d'extraction pour dent de sagesse supérieures

Wurzelheber  
Root Elevators  
Leve per radici  
Elevadores para raíces  
Elevateurs de racines



ROSIN  
**SI-10173**  
160 mm



WARWICK-JAMES  
**SI-10174**  
160 mm



WARWICK-JAMES  
**SI-10175**  
155 mm



WARWICK-JAMES  
**SI-10176**  
155 mm

Obere  
Upper  
Superiori  
Superiores  
Supérieures

Untere  
Lower  
Inferiori  
Inferiores  
Inférieures

Untere  
Lower  
Inferiori  
Inferiores  
Inférieures





Wurzelheber  
Root Elevators  
Leve per radici  
Elevadores para raíces  
Elevateurs à racines

Eine seite gezahnt  
One side serrated  
Un lato dentellato  
Dentadura mäs lado  
Dentelure sur un côté



Fig. 94



**SI-10176A**  
155 mm

Fig. 95



**SI-10177**  
155 mm

Fig. 100L



**SI-10178**  
155 mm

Fig. 100R



**SI-10179**  
155 mm



Wurzelheber  
Root Elevators  
Leve per radici  
Elevadores para raíces  
Elevateurs à racines

Gezahnt  
Serrated  
Dentellate  
Dentadas  
Dentelé

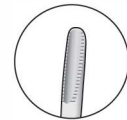
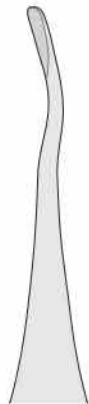

Fig. 301



APEXO  
**SI-10184**  
160 mm

Fig. 302



SI-10180

Fig. 303

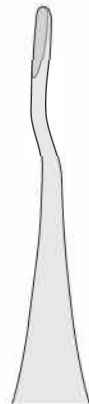

SI-10181



APEXO  
**SI-10185**  
160 mm

Fig. 77L



SI-10182

Fig. 77R

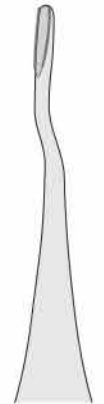

SI-10183



APEXO  
**SI-10186**  
160 mm



Wurzelheber  
Root Elevators  
Leve per radici  
Elevadores para raíces  
Elevateurs à racines

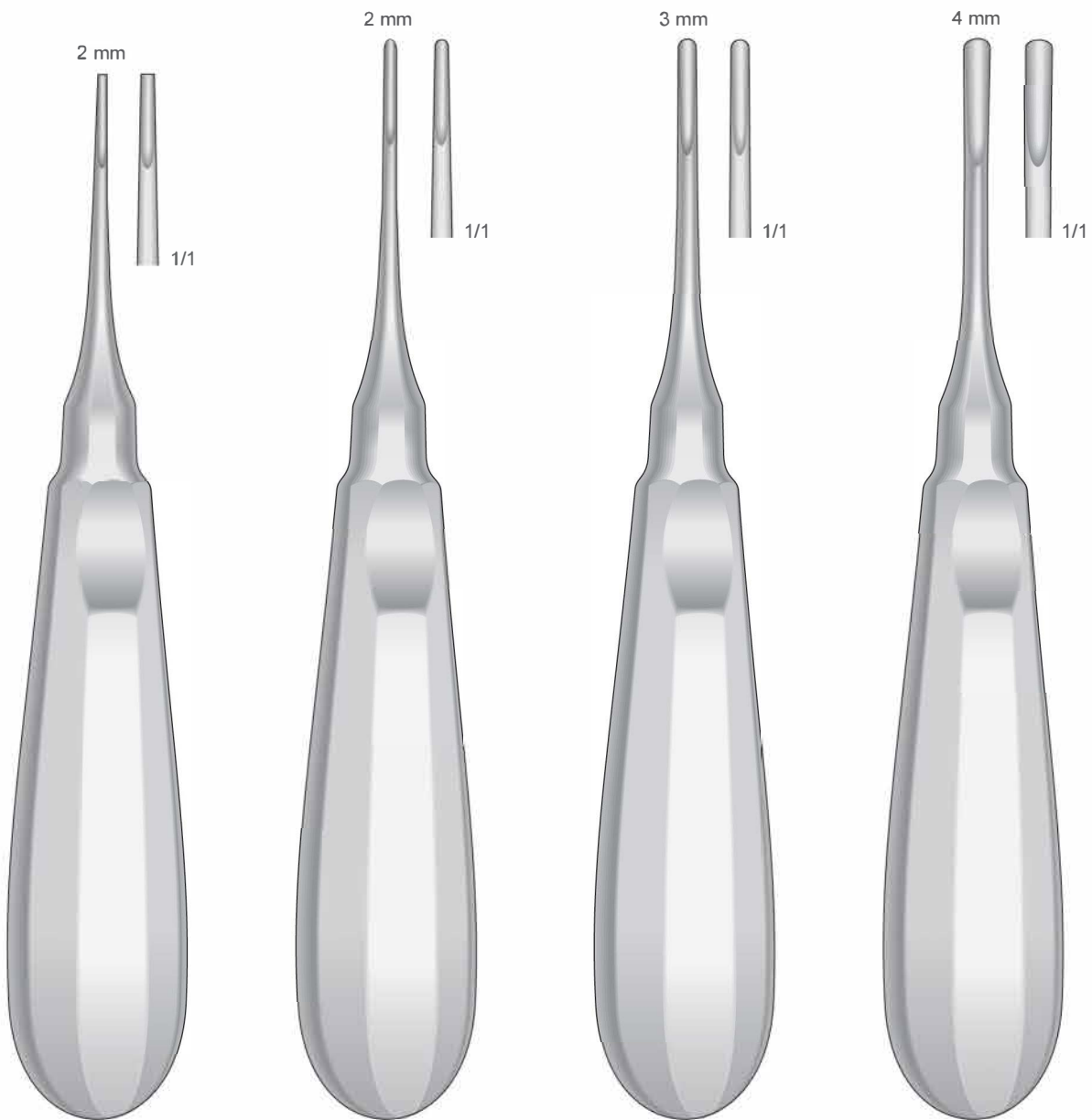

**SI-10187**  
150 mm

**SI-10188**  
155 mm

**SI-10189**  
155 mm

**SI-10190**  
155 mm



Wurzelheber  
Root Elevators  
Leve per radici  
Elevadores para raíces  
Elevateurs à racines

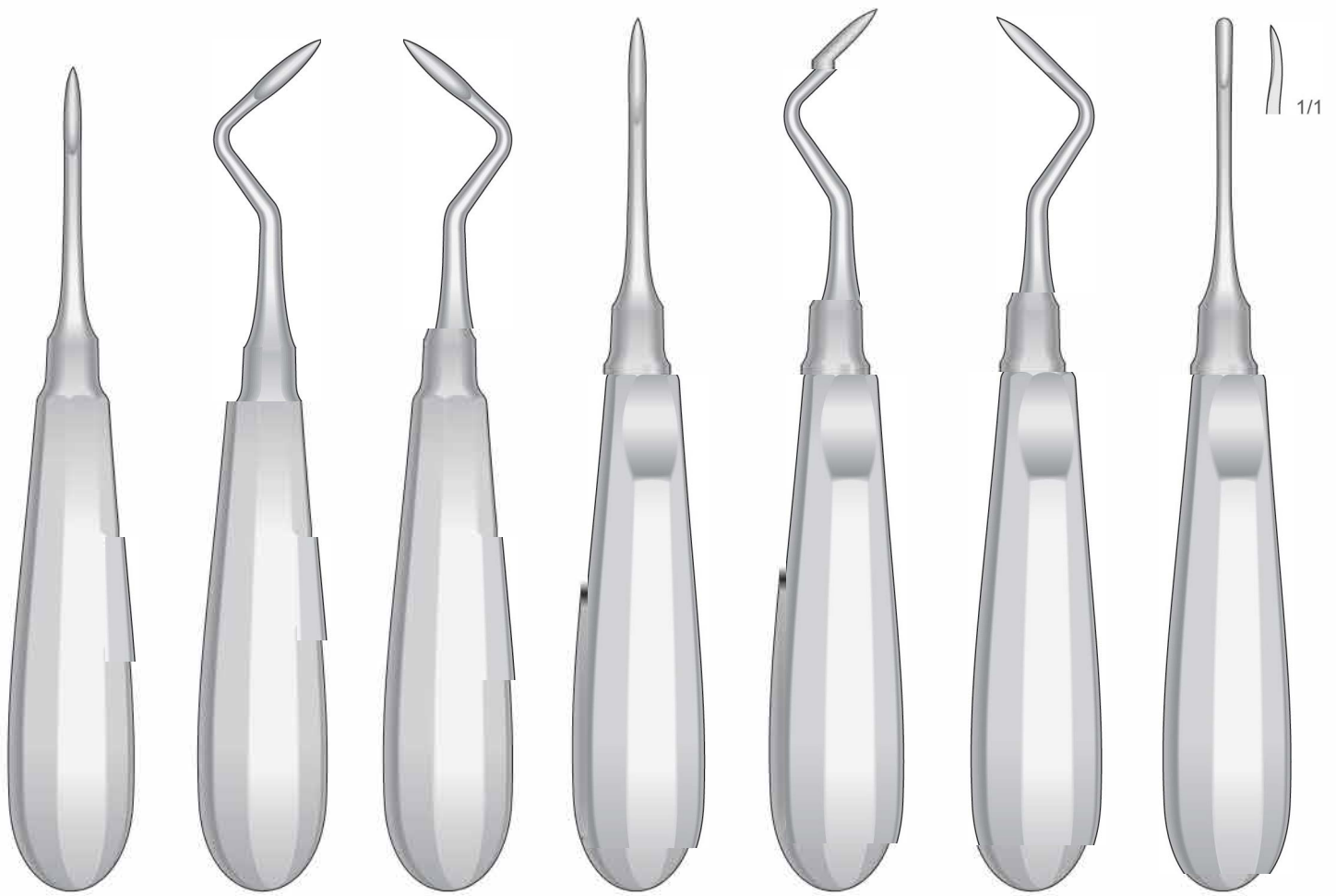

**SI-10191**  
140 mm

**SI-10192**  
150 mm

**SI-10193**  
150 mm

**SI-10194**  
155 mm

**SI-10195**  
155 mm

**SI-10196**  
155 mm

**SI-10197**  
155 mm



Wurzelheber  
Root Elevators  
Leve per radici  
Elevadores para raíces  
Elevateurs à racines

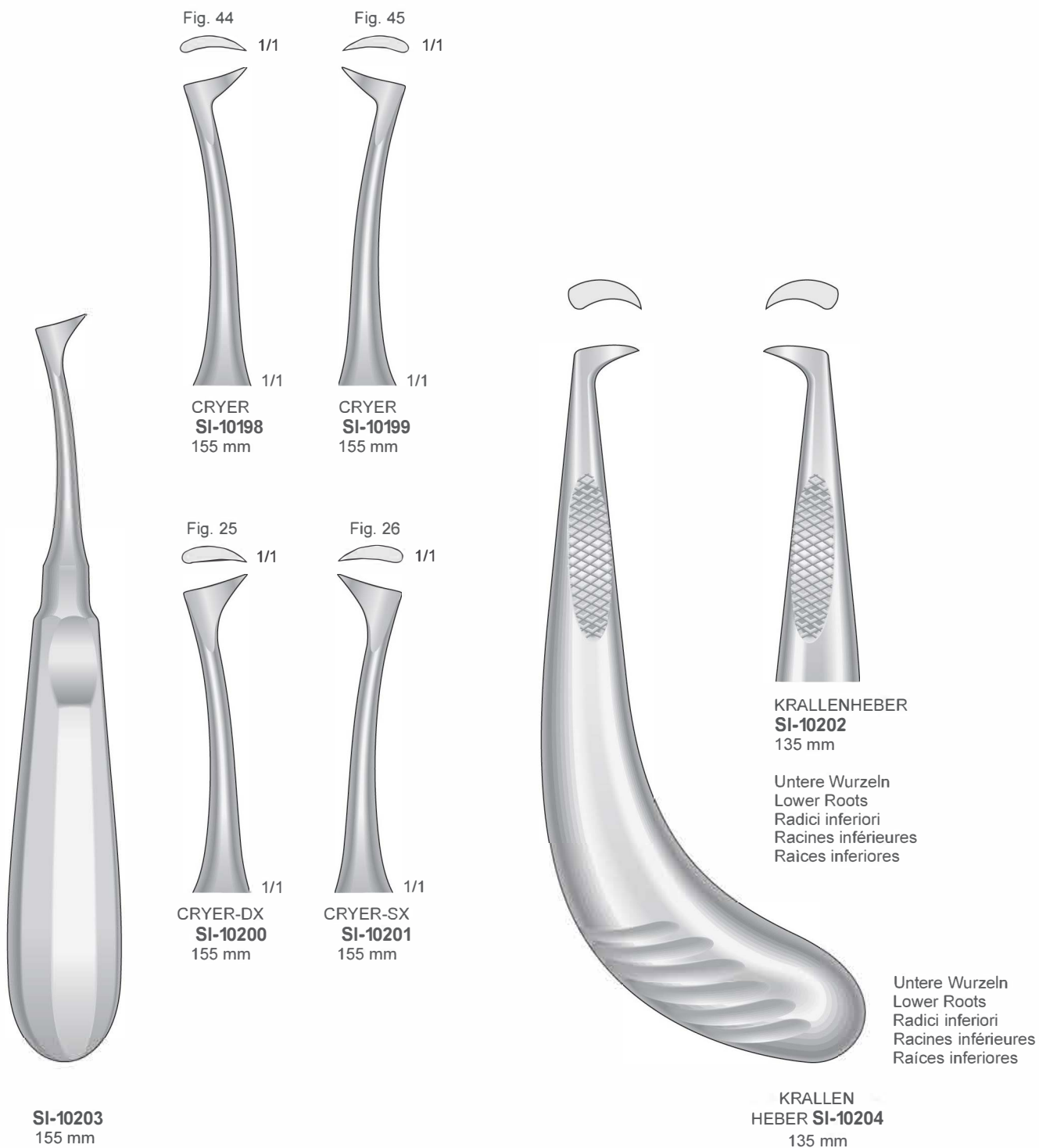





wurzelheber  
Root Elevators  
Leve per radici  
Elevadores para raíces  
Elevateurs à racines



**SI-10205**  
Large  
160 mm  
Angled IN



**SI-10206**  
Large  
160 mm  
Angled OUT



**SI-10207**  
Small  
160 mm  
Angled IN



**SI-10208**  
Small  
160 mm  
Angled OUT



**SI-10209**  
Straight  
160 mm



**SI-10210**  
Bayonet  
160 mm



**SI-10211**  
Curved  
160 mm

Fig. 1  
2,0 mm

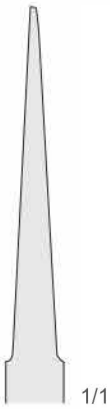

COUPLAND  
**SI-10212**  
155 mm

Fig. 2  
3,6 mm

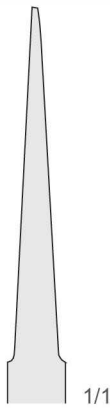

COUPLAND  
**SI-10213**  
155 mm

Fig. 3  
4,2 mm

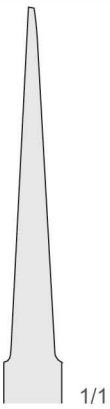

COUPLAND  
**SI-10214**  
155 mm

Fig. 1  
3,0 mm

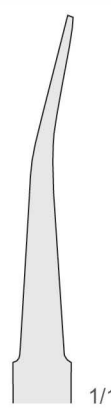

COUPLAND  
**SI-10215**  
155 mm

Fig. 2  
3,6 mm

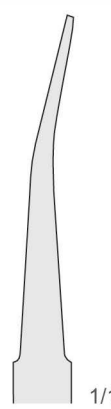

COUPLAND  
**SI-10216**  
155 mm

Fig. 3  
4,2 mm

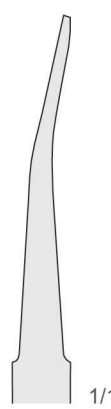

COUPLAND  
**SI-10217**  
155 mm



Wurzelheber  
Root Elevators  
Leve per radici  
Elevadores para raíces  
Elevateurs à racines

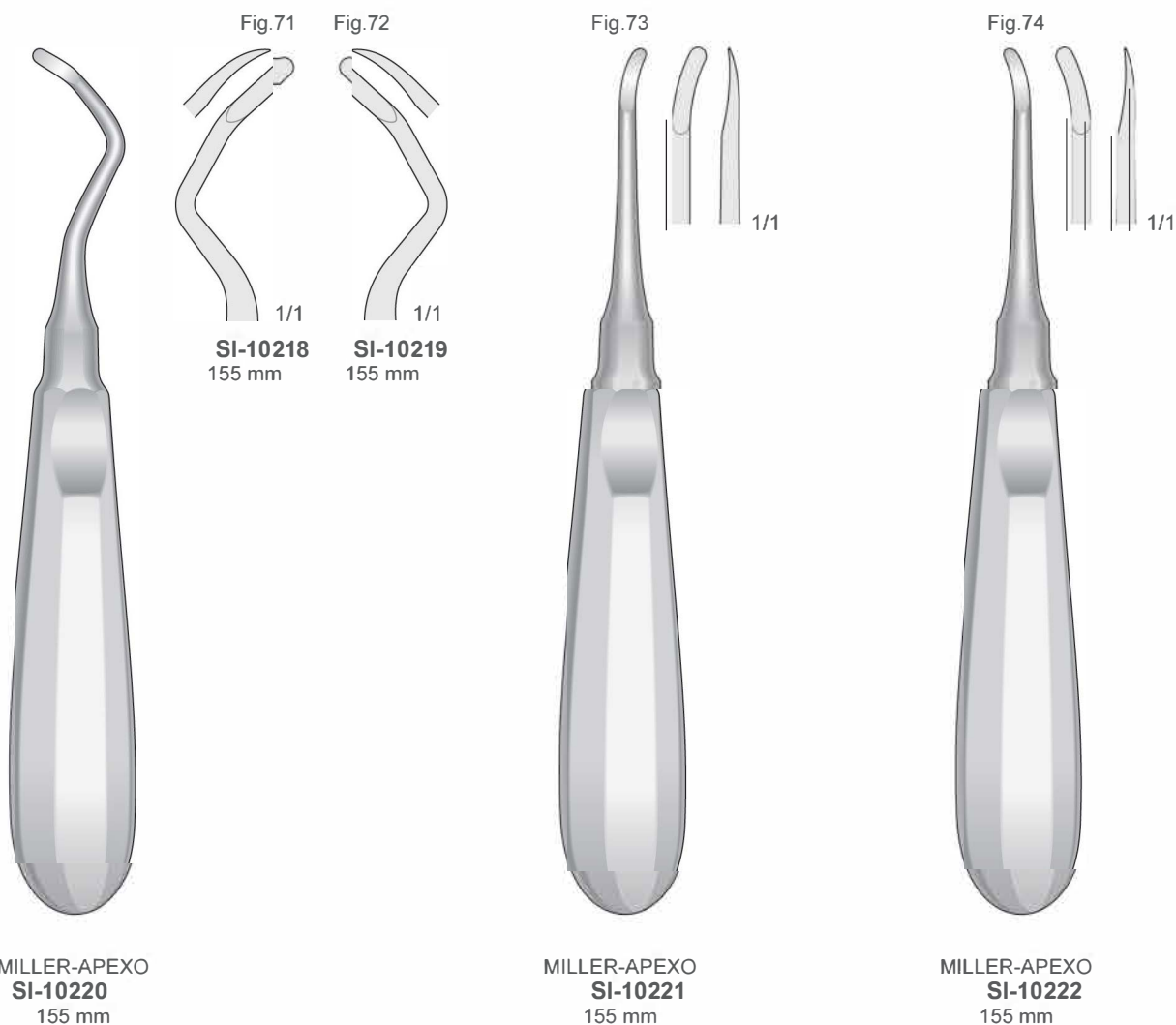



Root Elevators  
 Leve per radici  
 Elevadores para raíces  
 Elevateurs à racines



**HYLIN<sup>®</sup>**  
**SI-10228**  
 145 mm



**HYLIN**  
**SI-10222A**  
 145 mm



**HYLIN-2C**  
**SI-10223**  
 145 mm



**HYLIN-3C**  
**SI-10224**  
 145 mm



**HYLIN-1**  
**SI-10225**  
 145 mm

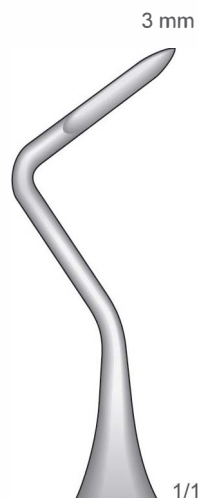

**HYLIN-2**  
**SI-10226**  
 145 mm

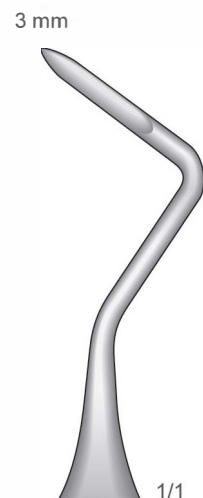

**HYLIN-3**  
**SI-10227**  
 145 mm



Wurzelheber  
Root Elevators  
Leve per radici  
Elevadores para raíces  
Elevateurs à racines



**KOPP**  
**SI-10229**  
130 mm



**KOPP**  
**SI-10230**  
130 mm



**SI-10231**  
130 mm



**SI-10232**  
155 mm



**LINDO-LEVIEN**  
**SI-10233**  
155 mm



Wurzelheber  
Root Elevators  
Leve per radici  
Elevadores para raíces  
Elevateurs à racines

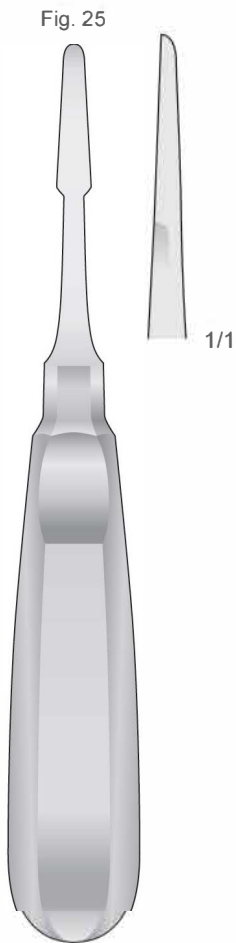

**SELDIN**  
**SI-10234**  
160 mm

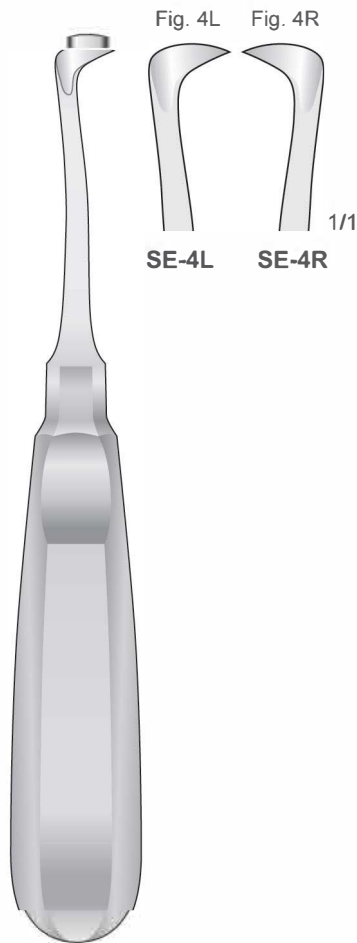

**SELDIN**  
**SI-10235**  
160 mm

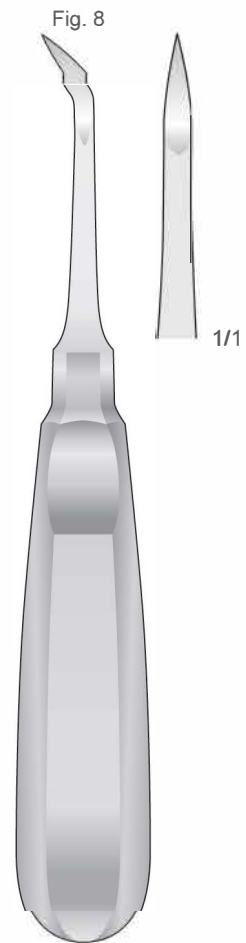

**CRANE PICK**  
**SI-10236**  
155 mm





Wurzelheber  
Root Elevators  
Leve per radici  
Elevadores para raíces  
Elevateurs à racines

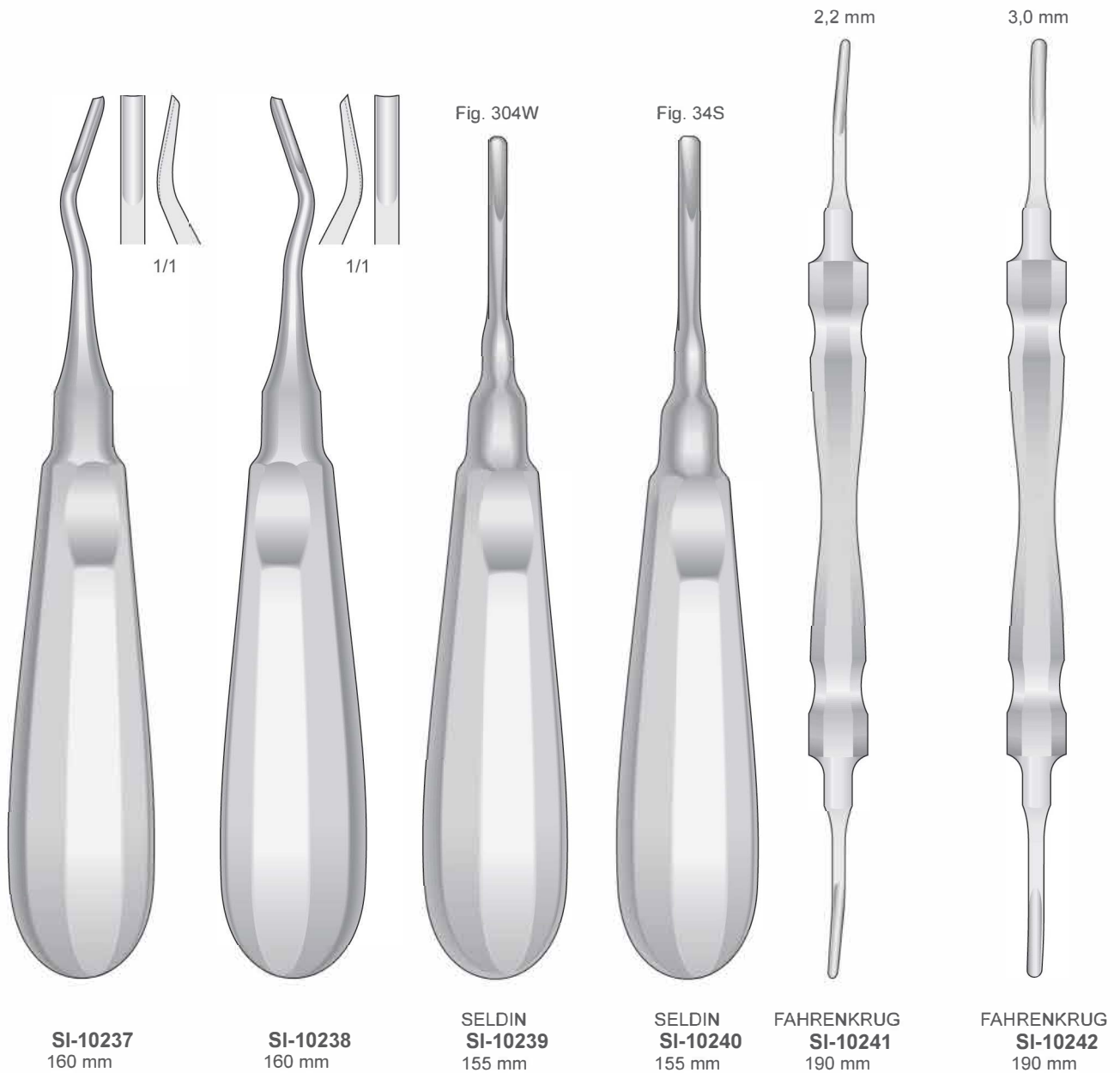



Wurzelheber  
Root Elevators  
Leve per radici  
Elevadores para raíces  
Elevateurs à racines

Fig. 6



POTT  
**SI-10243**  
160 mm

Fig. 7



POTT  
**SI-10244**  
160 mm

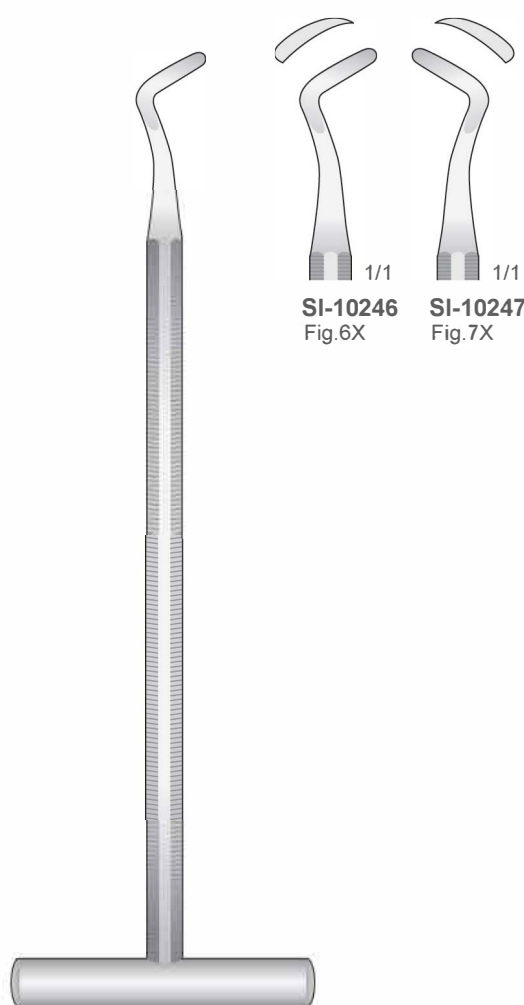

POTT  
**SI-10245**  
155 mm

**SI-10246**  
Fig.6X

**SI-10247**  
Fig.7X



Wurzelheber  
Root Elevators  
Leve per radici  
Elevadores para raíces  
Elevateurs à racines

Syndesmotome  
Syndesmotomes  
Sindesmotomi  
Syndesmôtomos  
Syndesmotomes



**BERNARD  
SI-10253**

Gerade  
Straight  
Diritto  
Rectas  
Droites



**BERNARD  
SI-10248**  
150 mm

Links  
Left  
Sinistra  
A la izquierda  
À gauche



**BERNARD  
SI-10249**  
140 mm

Rechts  
Right  
Destro  
A la derecha  
À droite



**BERNARD  
SI-10250**  
140 mm

Bajonett - Bayonet  
Baionetta - Bayoneta  
Baionette

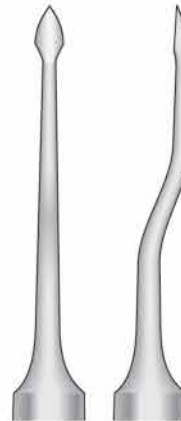

**BERNARD  
SI-10251**  
150 mm

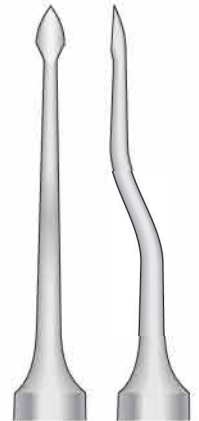

**BERNARD  
SI-10252**  
150 mm



Wurzelheber  
 Root Elevators  
 Leve per radici  
 Elevadores para raíces  
 Elevateurs à racines

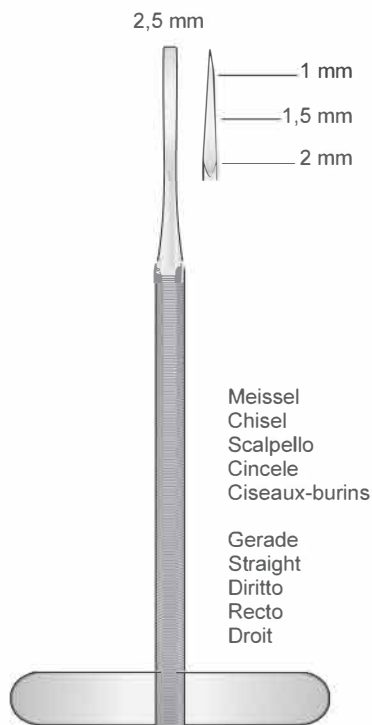

**SI-10254**  
130 mm

Meissel  
 Chisel  
 Scalpello  
 Cincele  
 Ciseaux-burins

Gerade  
 Straight  
 Diritto  
 Recto  
 Droit

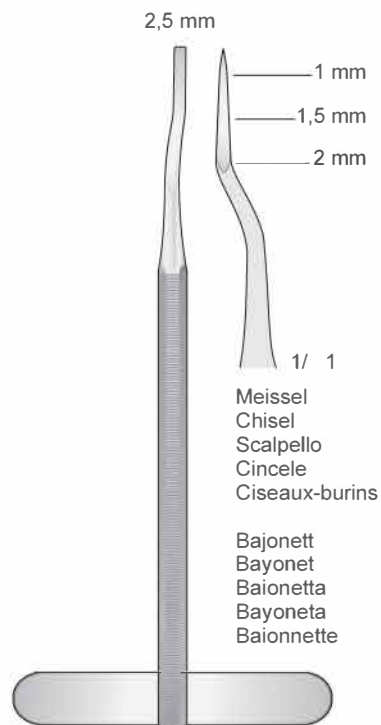

**SI-10255**  
130 mm

Meissel  
 Chisel  
 Scalpello  
 Cincele  
 Ciseaux-burins

Bajonett  
 Bayonet  
 Baionetta  
 Bayoneta  
 Baionnette

Syndesmotome  
 Syndesmotomes  
 Sindesmotomo  
 Syndesmòtomos  
 Syndesmotomes

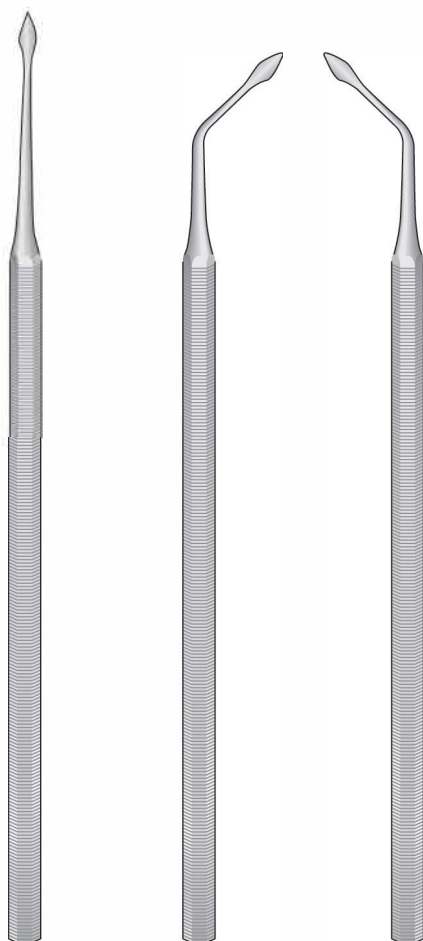

**SI-10256**  
158 mm

**SI-10257**  
152 mm

**SI-10258**  
152 mm

Raspatorien  
 Raspatories  
 Scollaperiosteo  
 Legras  
 Rugines

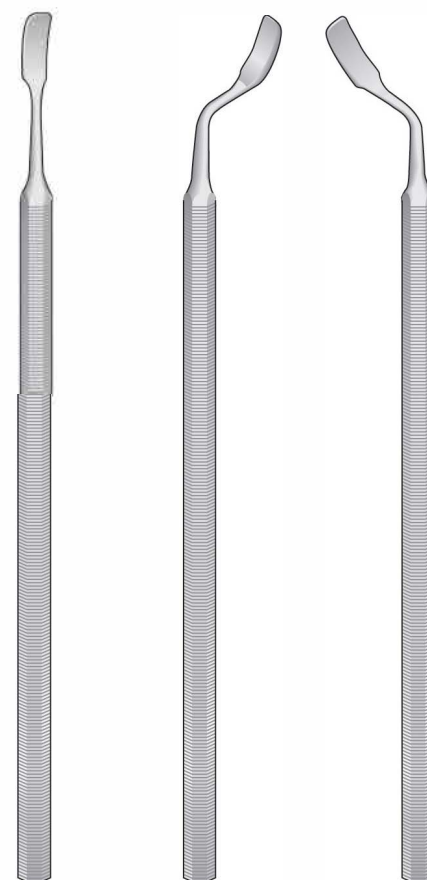

**SI-10259**  
150 mm

**SI-10260**  
150 mm

**SI-10261**  
150 mm



Wurzelheber  
Root Elevators  
Leve per radici  
Elevadores para rafces  
Elevateurs a racines



Untere Wurzeln  
Lower Roots  
Radici inferiori  
Raices inferiores  
Racines inférieures

Links  
Left  
Sinistra  
Izquierda  
Gauche

WINTER  
**SI-10262**  
Fig.1

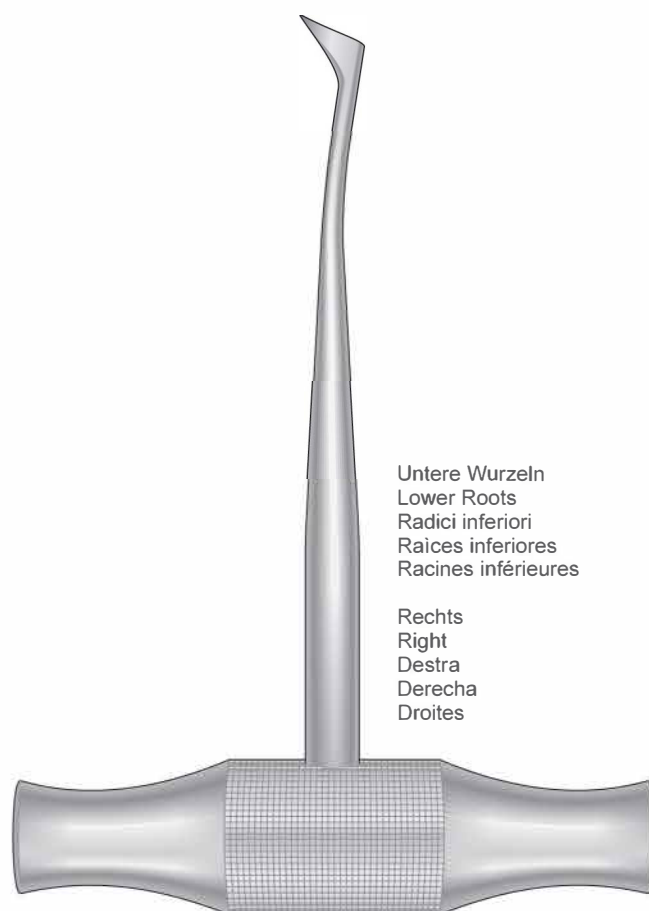

Untere Wurzeln  
Lower Roots  
Radici inferiori  
Raices inferiores  
Racines inférieures

Rechts  
Right  
Destra  
Derecha  
Droites

WINTER  
**SI-10263**  
Fig.2





Wurzeheber  
Root Elevators  
Leve per radici  
Elevadores para raíces  
Elevateurs à racines

Fig. 1L



WINTER  
**SI-10264**  
120 mm

Fig. 1R



WINTER  
**SI-10265**  
120 mm

Fig. 14L



WINTER  
**SI-10266**  
125 mm

Fig. 14R



WINTER  
**SI-10267**  
125 mm



Wurzelheber  
Root Elevators  
Leve per radici  
Elevadores para raíces  
Elevateurs à racines

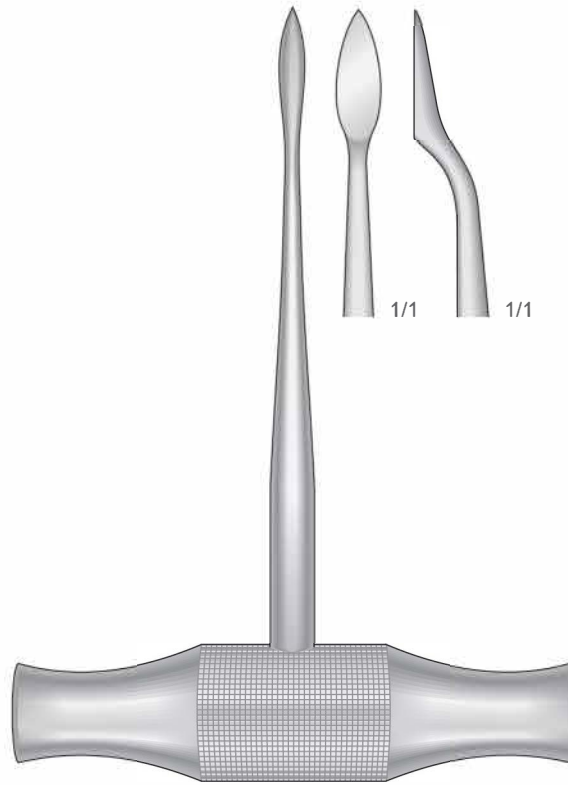

LECLUSE  
**SI-10268**  
130 mm

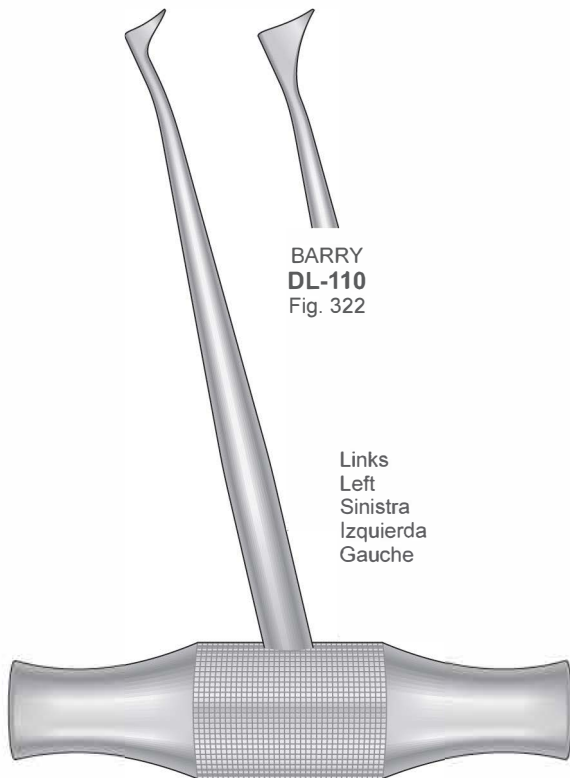
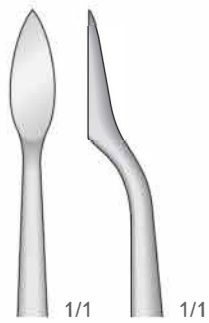

BARRY  
**SI-10269**  
Fig. 320 115 mm

Links  
Left  
Sinistra  
Izquierda  
Gauche



BARRY  
**SI-10270**  
Fig. 321 115 mm

Rechts  
Right  
Destra  
Derecha  
Droites



Wurzelheber  
Root Elevators  
Leve per radici  
Elevadores para raíces  
Elevateurs à racines

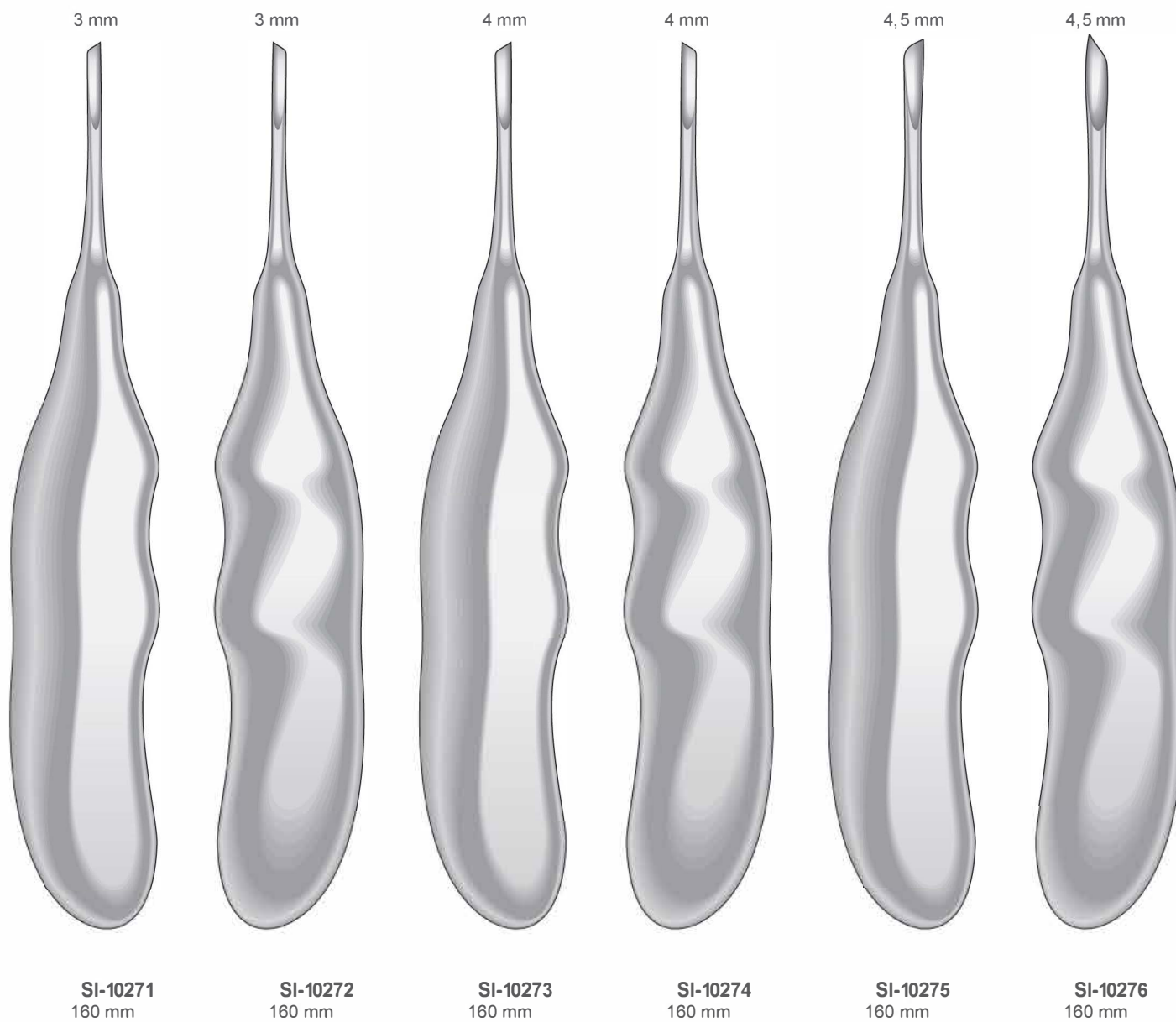



Wurzelheber  
Root Elevators  
Leve per radici  
Elevadores para raíces  
Elevateurs à racines

2 mm



**SI-10277**  
155 mm

3 mm



**SI-10278**  
155 mm

4 mm



**SI-10279**  
155 mm



**SI-10280**  
160 mm



**SI-10281**  
160 mm



Wurzelheber  
Root Elevators  
Leve per radici  
Elevadores para raíces  
Elevateurs à racines







Skalpelligriffe - Mikro Skalpellklingen  
 Scalpel Handles - Micro Scalpel Blades  
 Manici per bisturi - Micro lame per bisturi  
 Mangos de bisturi - Micro hojas de bisturi  
 Manches pour bistouris - Micro lames de bistouri



**SI-10286**  
 Packung 10 Klingen  
 Package 10 blades  
 Scatola da 10 lame  
 Cajita de 10 hojas  
 Boite de 10 lames

Skalpelligriffe für Mikro-Klingen  
 Scalpel handles for Micro blades  
 Manici per micro lame  
 Mangos de bisturi para micro hojas  
 Manches de bistouris pour micro lames

Micro-Klingen  
 Micro blades  
 Micro lame  
 Micro hojas  
 Micro lames

Rasierklingen-Brecker und halter  
 Razor blade breaker and holder  
 Manico porta lame  
 Mango para Hojas de afeitar  
 Porte lames à rasoir

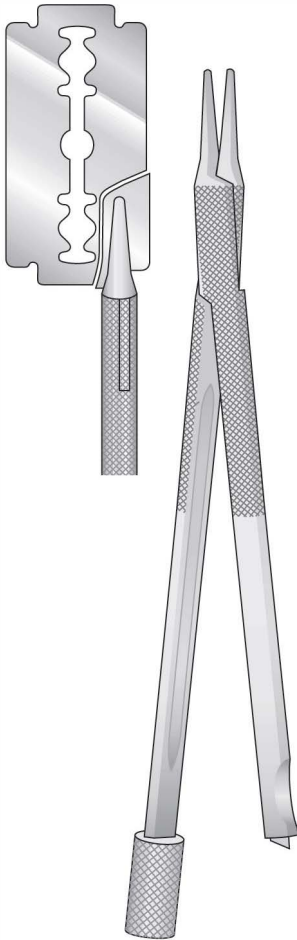

**SI-10296**

120  
mm



**SI-10297**

135 mm



**SI-10298**

155  
mm



**SI-10287**  
 Conf. 10 pz.



**SI-1028/8**  
 Conf. 10 pz.



**SI-10289**  
 Conf. 1 pz.



**SI-10290**  
 Conf. 10 pz.



**SI-10291**  
 Conf. 10 pz.



**SI-10292**  
 Conf. 1 pz.



**SI-10293**  
 Conf. 10 pz.



**SI-10294**  
 Conf. 10 pz.



**SI-10295**  
 Conf. 1 pz.



Skalpelligriffe  
Scalpel Handles  
Manici porta lame  
Mangos de bisturí  
Manches de bistouri

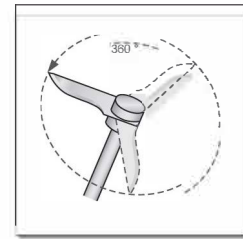

Für Mikro-Klingen  
For Micro Blades  
Per micro lame  
Para micro Hojas  
Pour Micro-Lame de bistouris



**SI-10299**  
100 mm



**SI-10300**  
130 mm



**SI-10301**  
150 mm

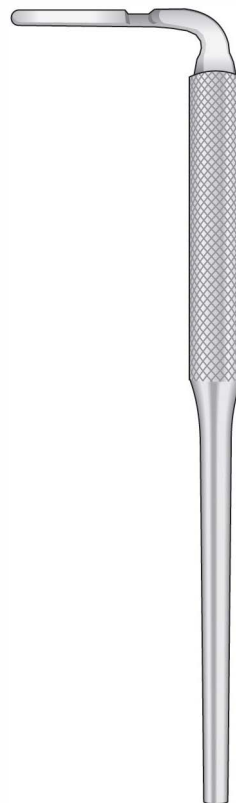

**SI-10302**  
120 mm

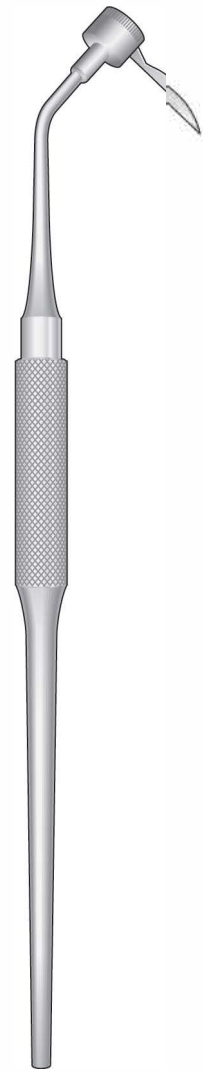

**SI-10303**  
165 mm



Skalpelle und Skalpellgriffe  
Scalpel Blades and Handle  
Lame e manici per bisturi  
Hojas y mangos de bisturí  
Lames et manches de bistouri

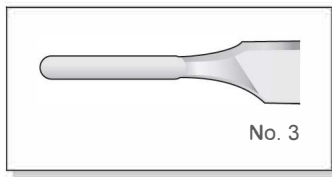

Packungen à 100  
Packages of 100 ea  
Scatole da 100 pezzi  
Cajas de 100 c/u  
Boîtes de 100 pièces



**SI-10304**  
Fig. 10



**SI-10305**  
Fig. 11

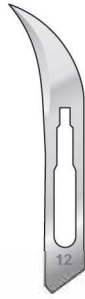

**SI-10306**  
Fig. 12



**SI-10307**  
Fig. 12D



**SI-10308**  
Fig. 13

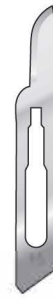

**SI-10309**  
Fig. 15

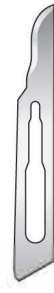

**SI-10310**  
Fig. 15A

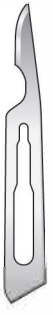

**SI-10311**  
Fig. 15C



**SI-10312**



**SI-10313**  
Fig. 3M



**SI-10314**



**SI-10315**



**SI-10316**  
Fig. 5



**SI-10317**  
Fig. 5A



**SI-10318**  
155 mm

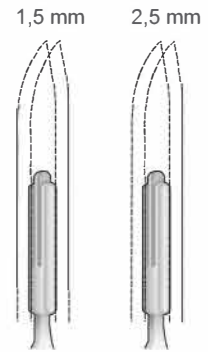

**SI-10319** **SI-10320**

Doppelt Skalpellgriff  
Scalpel Handle double Blade  
Manico per bisturi a doppia lama  
Mango de bisturí doble hojas  
Manche pour bistouri double-lames



Skalpelle  
Scalpel Blades  
Lame per bisturi  
Hojas de bisturí  
Lames de bistouri

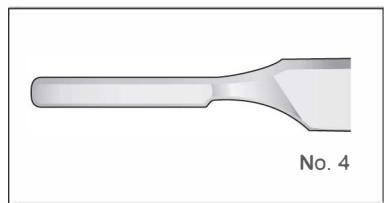

Packungen à 100  
Packages of 100 ea  
Scatole da 100 pezzi  
Cajas de 100 c/u  
Boîtes de 100 pièces



**SI-10321**  
Fig. 18



**SI-10322**  
Fig. 20



**SI-10323**  
Fig. 21



**SI-10324**  
Fig. 23



Palatal, Gingival,  
Connective Tissue Grafts  
Uses standard  
double-edged  
razor blade

Mucotomo

**PAQUETTE  
BLADE HOLDER**  
**SI-10325**  
160 mm



**SI-10326**  
Fig. 4

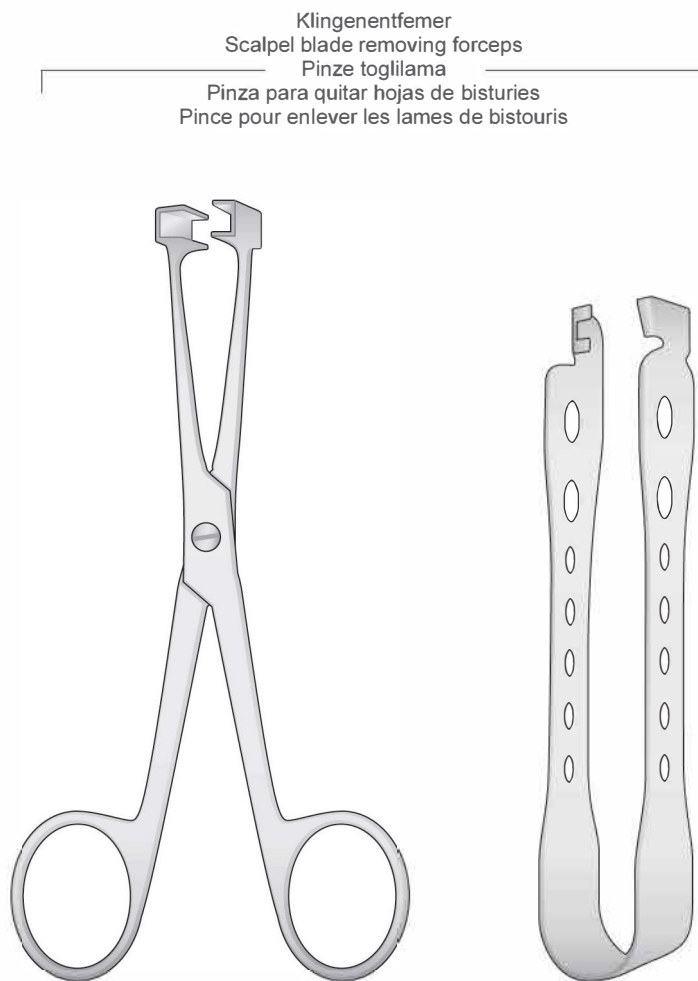

Klingenentfemer  
Scalpel blade removing forceps  
Pinze togliilama  
Pinza para quitar hojas de bisturíes  
Pince pour enlever les lames de bistouris

**SI-10327**  
135 mm

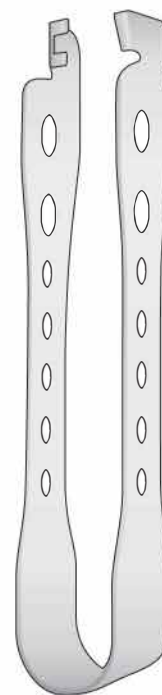

**SI-10328**  
115 mm



Messer  
Knives  
Coltelli  
Cuchillos  
Couteaux



**ZIEGLER**  
**SI-10336**  
115 mm



**SI-10329**  
5 mm



**SI-10330**  
6 mm

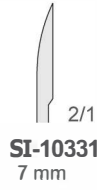

**SI-10331**  
7 mm



**GRAEFE**  
**SI-10337**



**SI-10332**  
125 mm



**SI-10333**  
135 mm



**GRAEFE**  
**SI-103387**  
140 mm

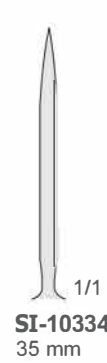

**SI-10334**  
35 mm

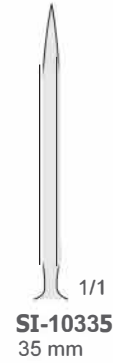

**SI-10335**  
35 mm



**LA FORCE**  
**SI-10338**  
120 mm



**ELLIS**  
**SI-10339**  
120 mm



**SI-10340**  
125 mm



**SI-10341**  
125 mm



**SI-10342**  
125 mm





Messer  
Knives  
Coltelli  
Cuchillos  
Couteaux



**SI-10349**



**SI-10343**  
120 mm

1/1



**SI-10344**  
125 mm

1/1



**SI-10345**  
130 mm

1/1



**SI-10346**  
120 mm

1/1



**SI-10347**  
125 mm

1/1



**SI-10348**  
130 mm

1/1



Mikro-Scheren  
Micro Scissors  
Micro Forbici  
Micro Tijeras  
Micro Ciseaux

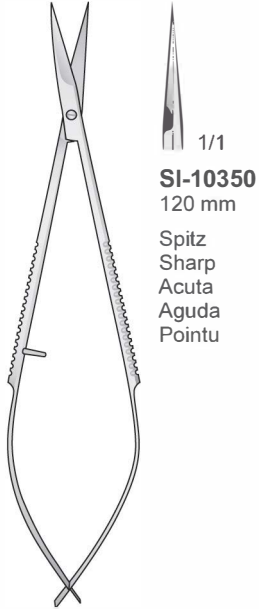

1/1  
**SI-10350**  
120 mm  
Spitz  
Sharp  
Acuta  
Aguda  
Pointu

NOYES  
**SI-10354**  
120 mm

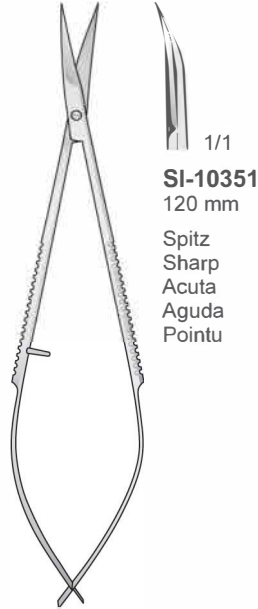

1/1  
**SI-10351**  
120 mm  
Spitz  
Sharp  
Acuta  
Aguda  
Pointu

NOYES  
**SI-10355**  
120 mm

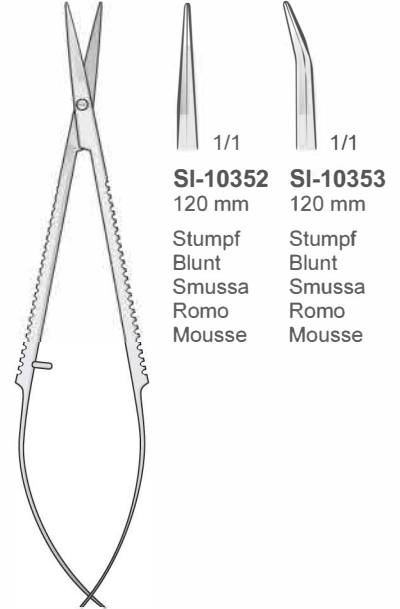

1/1 1/1  
**SI-10352** **SI-10353**  
120 mm 120 mm  
Stumpf  
Blunt  
Smussa  
Romo  
Mousse

**SI-10356**  
120 mm

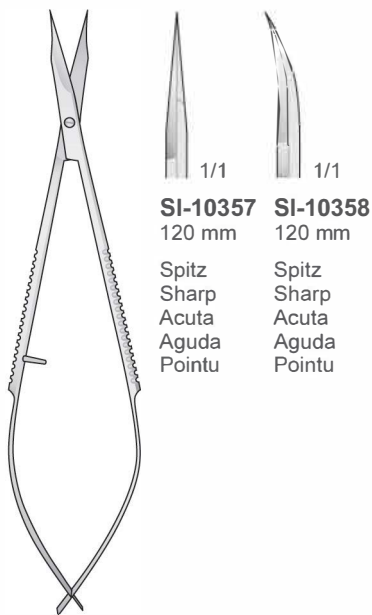

1/1 1/1  
**SI-10357** **SI-10358**  
120 mm 120 mm  
Spitz  
Sharp  
Acuta  
Aguda  
Pointu

WESTCOTT  
**SI-10363**  
120 mm

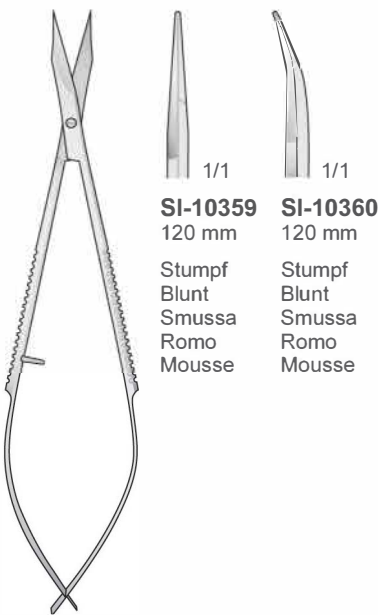

1/1 1/1  
**SI-10359** **SI-10360**  
120 mm 120 mm  
Stumpf  
Blunt  
Smussa  
Romo  
Mousse

WESTCOTT  
**SI-10364**  
120 mm

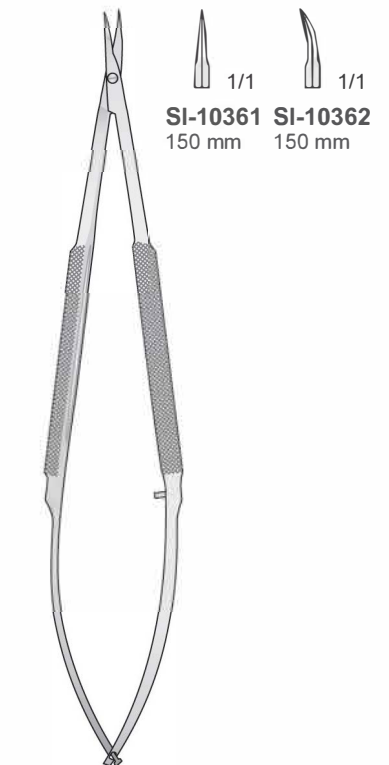

1/1 1/1  
**SI-10361** **SI-10362**  
150 mm 150 mm

**SI-10365**  
150 mm



Scheren  
Scissors  
Forbici  
Tijeras  
Ciseaux

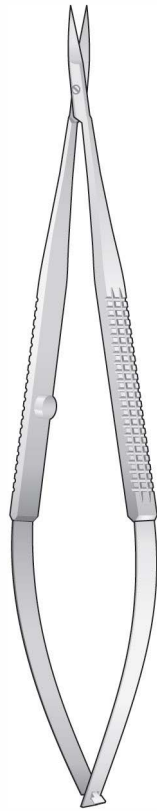

**SI-10370**  
160 mm



**SI-10366**  
160 mm  
Spitz  
Sharp  
Acuta  
Aguda  
Pointu

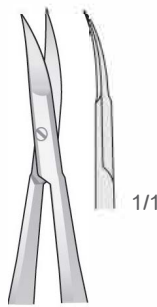

**SI-10367**  
160 mm  
Spitz  
Sharp  
Acuta  
Aguda  
Pointu



**SI-10371**  
145 mm

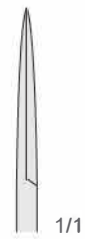

**SI-10368**  
145 mm  
Spitz  
Sharp  
Acuta  
Aguda  
Pointu



**SI-10369**  
145 mm  
Spitz  
Sharp  
Acuta  
Aguda  
Pointu

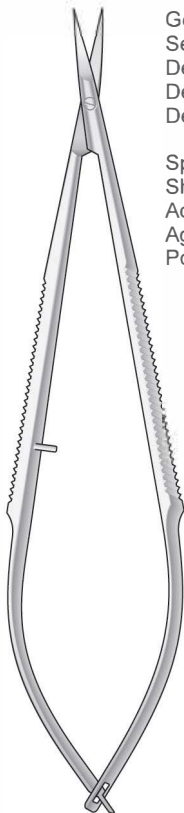

**SI-10372**  
160 mm

Gezahnt  
Serrated  
Dentellata  
Dentada  
Dentelé  
  
Spitz  
Sharp  
Acuta  
Aguda  
Pointu

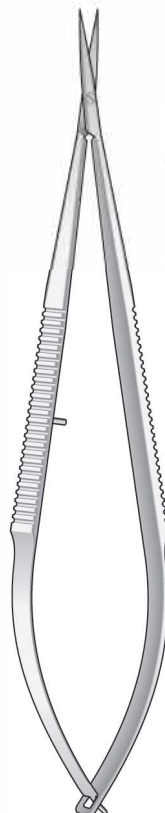

**SI-10373**  
160 mm

1/1  
**SI-10373A**  
160 mm  
Spitz  
Sharp  
Acuta  
Aguda  
Pointu



**SI-10374**  
160 mm

1/1  
**SI-10374A**  
160 mm  
Spitz  
Sharp  
Acuta  
Aguda  
Pointu



Scheren  
Scissors  
Forbici  
Tijeras  
Ciseaux

Spitz - Sharp  
Acuta - Aguda  
Pointu

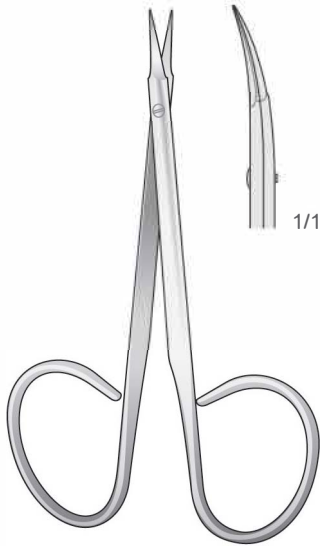

STITCH  
**SI-10377**  
115 mm

Iris Scheren - Iris scissors  
Forbici Iris - Tijeras Iris  
Ciseaux Iris

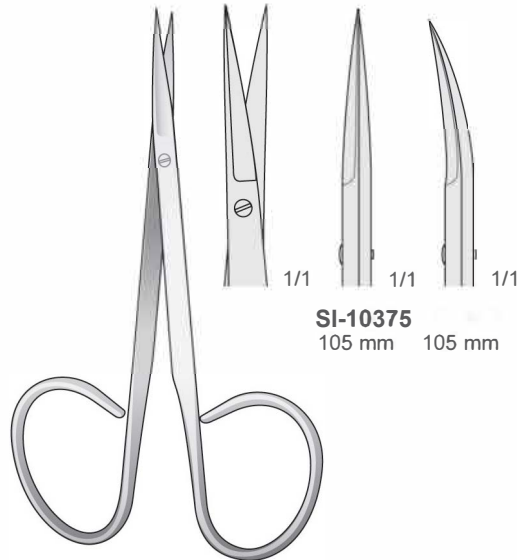

**SI-10378**  
105 mm

**SI-10375**  
105 mm 105 mm

Stumpf - Blunt  
Smussa - Romas  
Mousse

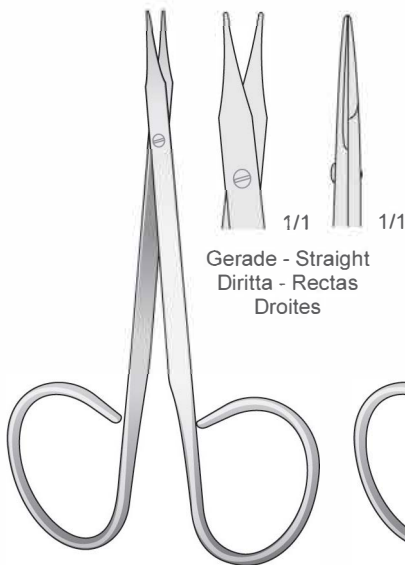

STEVENS  
**SI-10379**  
100 mm

Gerade - Straight  
Diritta - Rectas  
Droites

Stumpf - Blunt  
Smussa - Romas  
Mousse

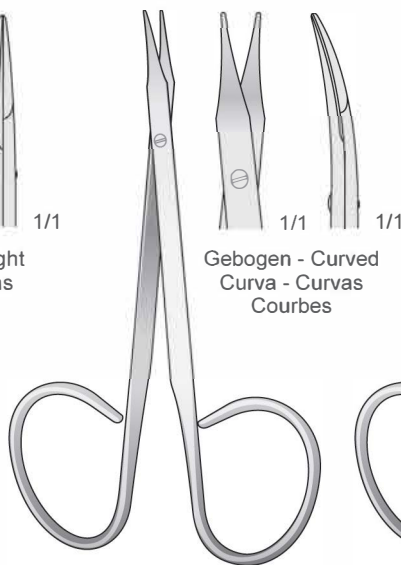

STEVENS  
**SI-10380**  
100 mm

Gebogen - Curved  
Curva - Curvas  
Courbes

Spitz - Sharp  
Acuta - Aguda  
Pointu

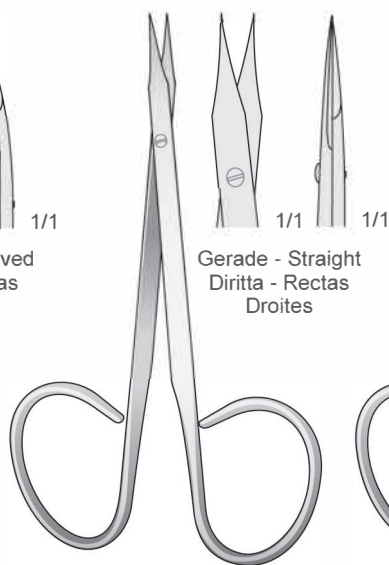

WALTON  
**SI-10381**  
100 mm

Gerade - Straight  
Diritta - Rectas  
Droites

Spitz - Sharp  
Acuta - Aguda  
Pointu

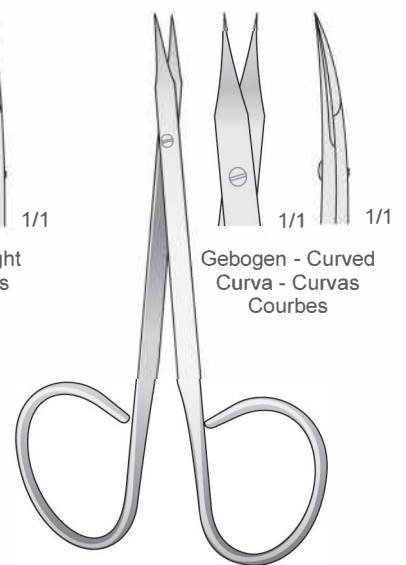

WALTON  
**SI-10382**  
100 mm

Gebogen - Curved  
Curva - Curvas  
Courbes



Scheren  
Scissors  
Forbici  
Tijeras  
Ciseaux

L = links  
left  
mancini  
izquierdo  
gauche

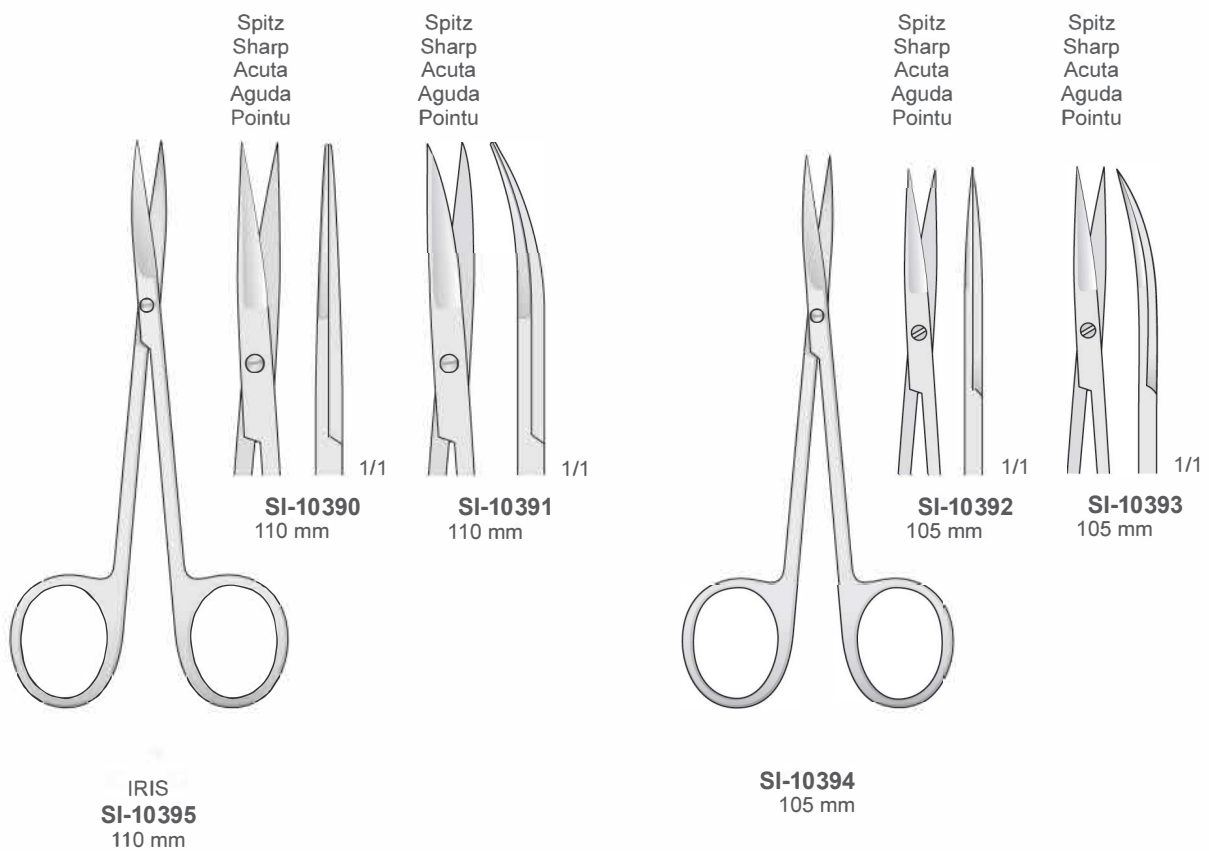
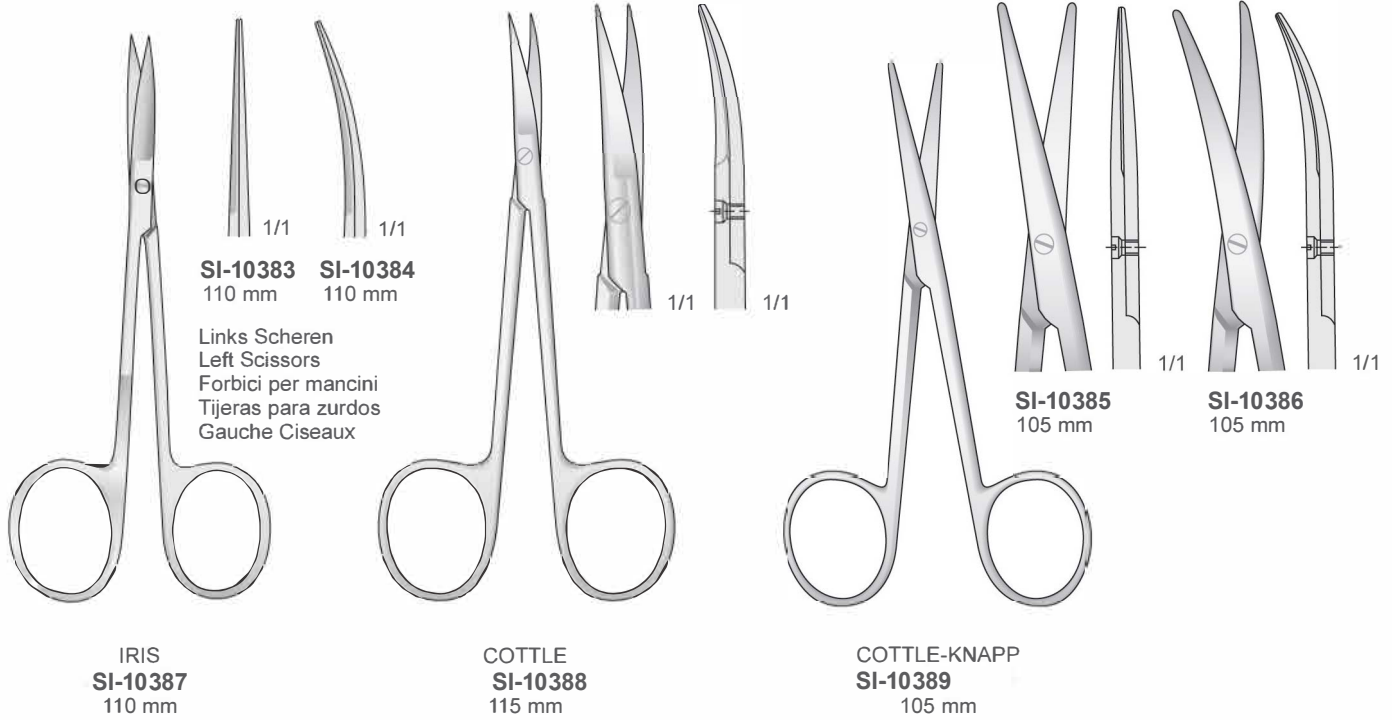



General  
Scissors  
Forbici  
Tijeras  
Ciseaux

Gezahnt - Serrated  
Dentellata - Dentelé - Dentadas



**SI-10396**  
110 mm

**SI-10397**  
110 mm

Gezahnt - Serrated  
Dentellata - Dentelé - Dentadas

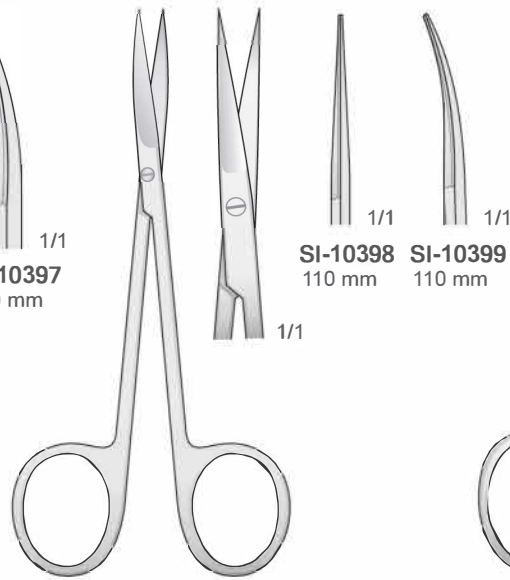

**SI-10398**  
110 mm

**SI-10399**  
110 mm

**SI-10400**  
110 mm

**SI-10401**  
110 mm

**KILNER**  
**SI-10402**  
115 mm

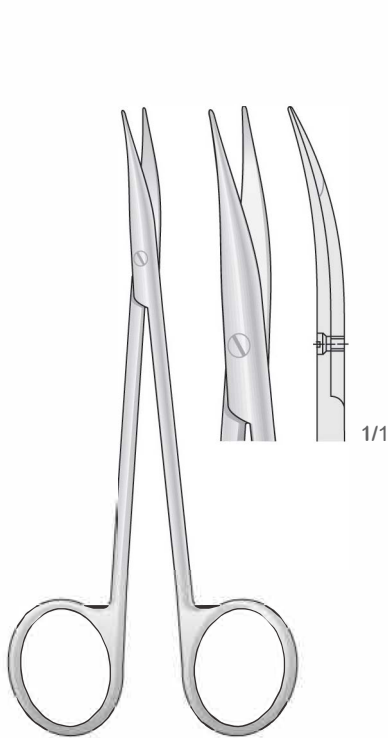

**JAMESON-WERBER**  
**SI-10404**  
130 mm

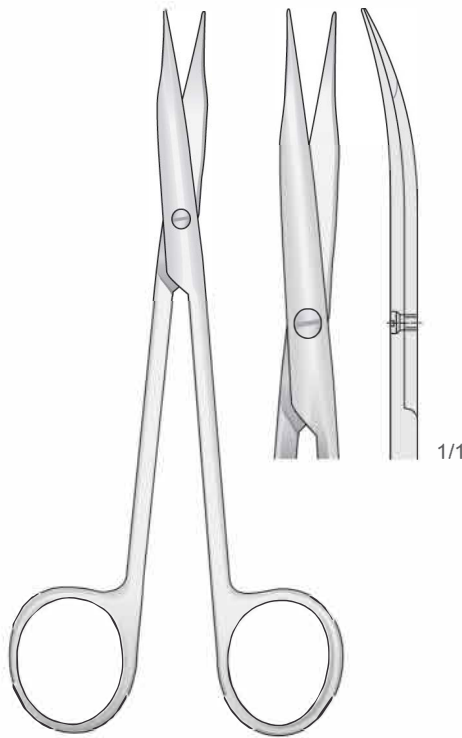

**JAMESON**  
**SI-10405**  
145 mm

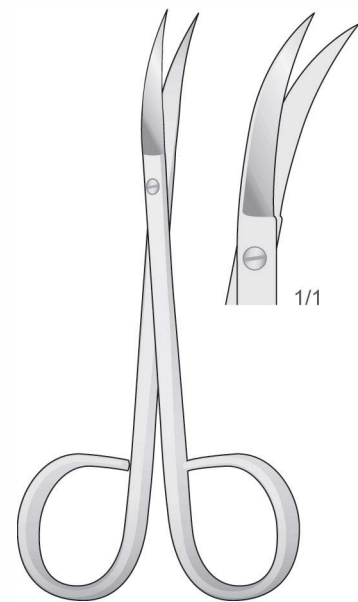

**SI-10403**  
115 mm





Scheren  
Scissors  
Forbici  
Tijeras  
Ciseaux

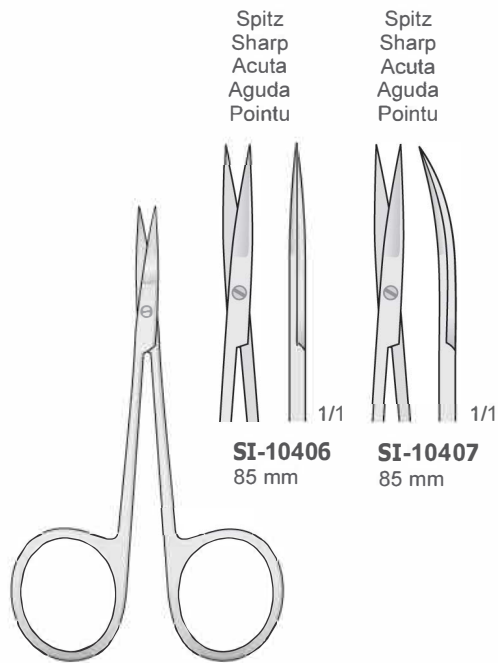

MICO-IRIS  
**SI-10410**  
85 mm

**SI-10411**  
110mm

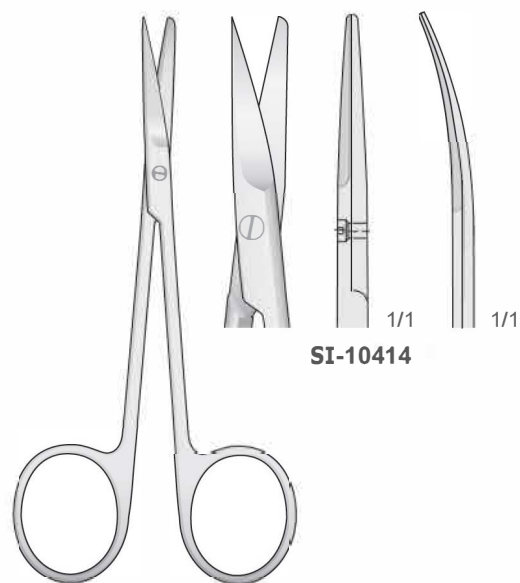
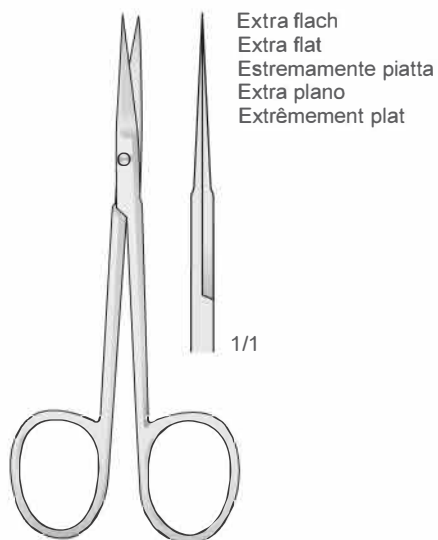

**SI-10413**  
110 mm



Scheren  
Scissors  
Forbici  
Tijeras  
Ciseaux

Spitz - Sharp  
Acuta - Agudo  
Aigu

Spitz - Sharp  
Acuta - Agudo  
Aigu



**SI-10415**

**SI-10416**

**SI-10417**

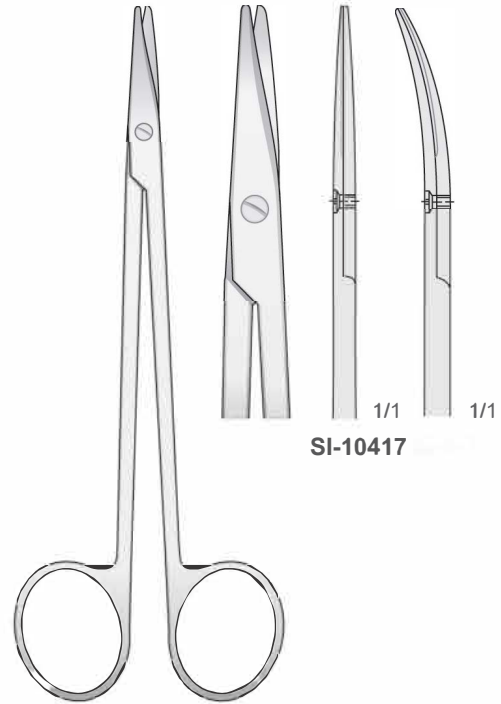

**METZENBUM**  
**SI-10418**  
145 mm

**METZENBAUM**  
**SI-10419**  
150 mm

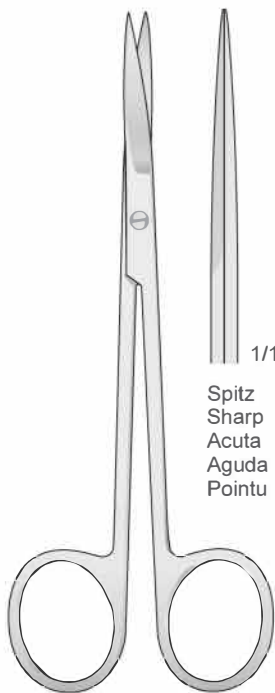

1/1  
Spitz  
Sharp  
Acuta  
Aguda  
Pointu

**METZENBAUM**  
**SI-10420**  
145 mm

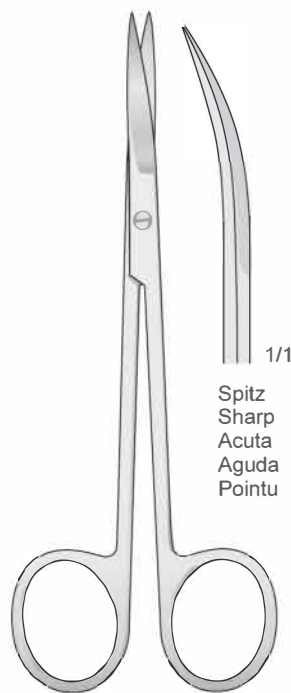

1/1  
Spitz  
Sharp  
Acuta  
Aguda  
Pointu

**METZENBAUM**  
**SI-10421**  
145 mm

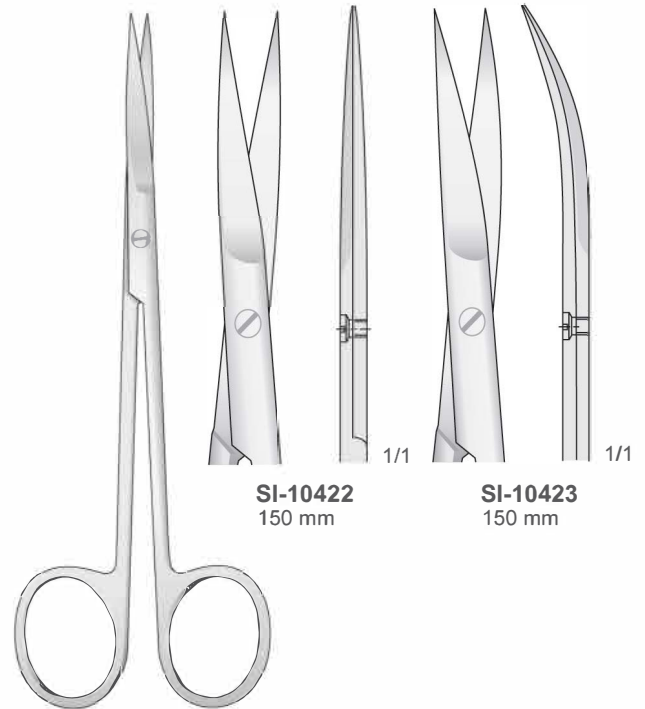

**SI-10422**  
150 mm

**SI-10423**  
150 mm

**JOEPH**  
**SI-10424**  
150 mm



Scheren  
Scissors  
Forbici  
Tijeras  
Ciseaux

Stumpf  
Blunt  
Smussa  
Romas  
Mousse

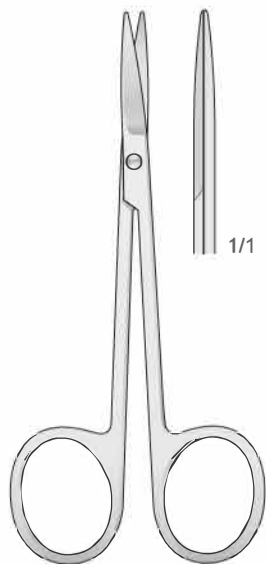

**SI-10425**  
110 mm

Stumpf  
Blunt  
Smussa  
Romas  
Mousse

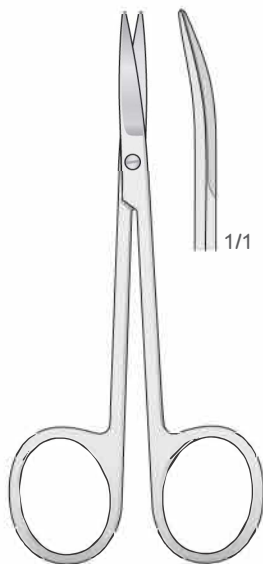

**SI-10426**  
110 mm

Stumpf  
Blunt  
Smussa  
Romas  
Mousse

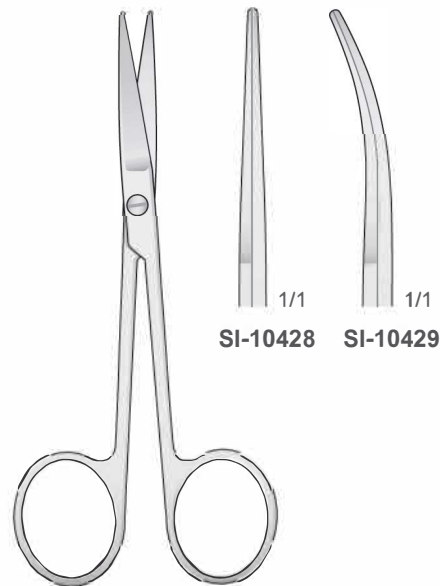

**SI-10427**  
115 mm

Spitz  
Sharp  
Acute  
Agudas  
Pointu

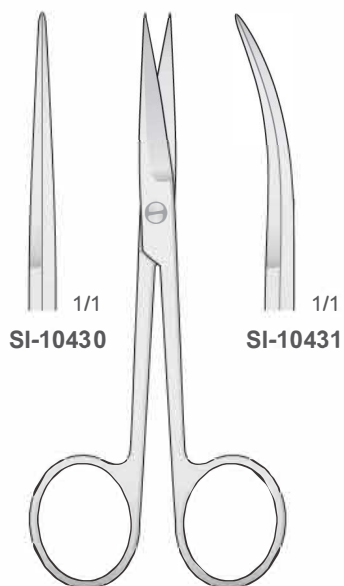

**SI-10430**

**SI-10432**  
115 mm



**SI-10431**

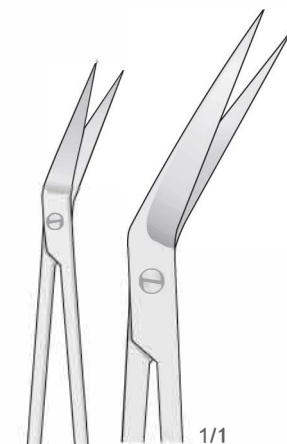

LOCKLIN  
**SI-10433**  
115 mm

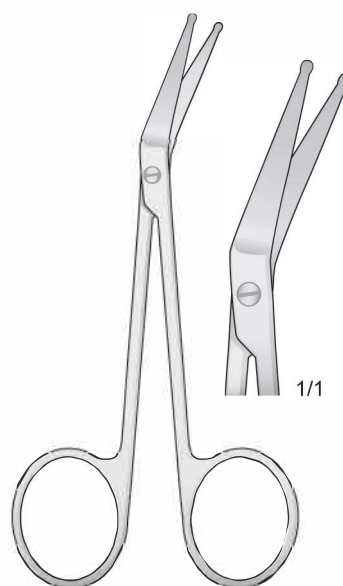

LOCKLIN MOD.  
**SI-10434**  
110 mm



Scheren  
Scissors  
Forbici  
Tijeras  
Ciseaux



**KILNER**  
**SI-10435**  
130 mm

Mit einer Schneide gezahnt  
With one blade serrated  
Con una lama zigrinata  
Con una hoja dentada  
Avec lame dentelé



**SI-10436**  
120 mm

Gezahnt - Serrated  
Dentellata - Dentadas  
Dentelé

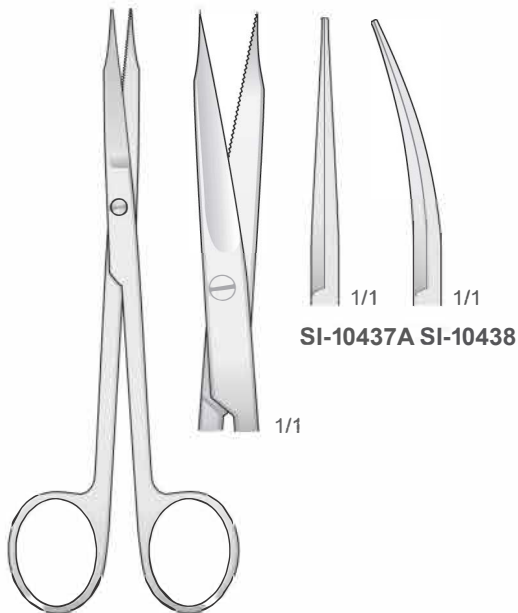

**GOLDMAN-FOX**  
**SI-10437**  
120 mm

Gezahnt - Serrated  
Dentellata - Dentadas  
Dentelé



**GOLDMAN-FOX**  
**SI-10441**  
130 mm



Scheren  
Scissors  
Forbici  
Tijeras  
Ciseaux

Gezahnt - Serrated  
Dentellata - Dentadas  
Dentelé



LOCKLIN  
SI-10442  
160 mm

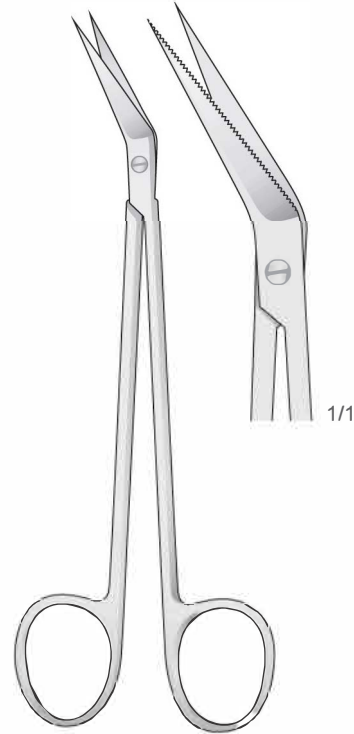

LOCKLIN  
SI-10443  
160 mm

Gezahnt - Serrated  
Dentellata - Dentadas  
Dentelé

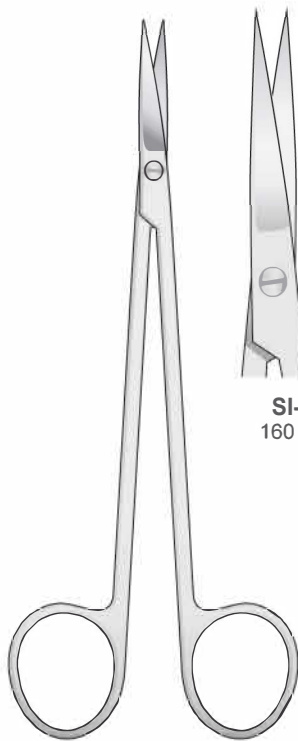

KELLY  
SI-10448  
160 mm



SI-10444  
160 mm

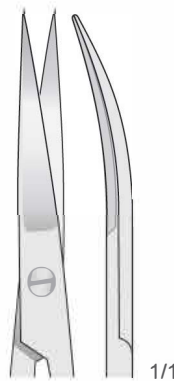

SI-10445  
160 mm

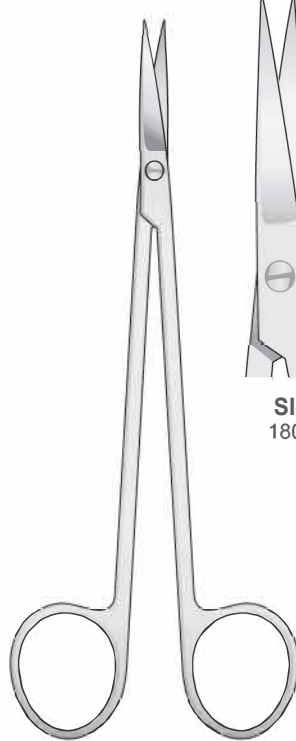

KELLY  
SI-10449  
180 mm



SI-10446  
180 mm

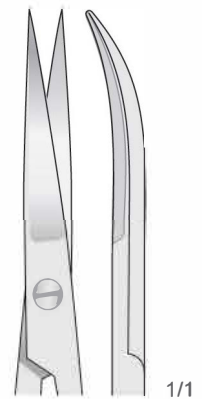

SI-10447  
180 mm



Scheren  
Scissors  
Forbici  
Tijeras  
Ciseaux

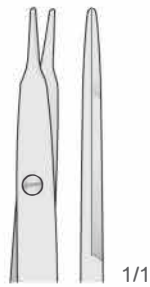
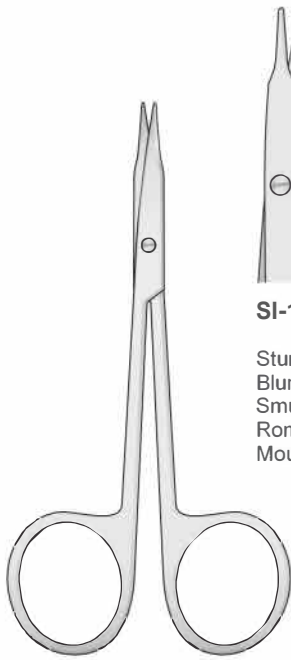

**SI-10450**

Stumpf Gerade  
Blunt Straight  
Smussa Diritta  
Romas Rectas  
Mousse Droites

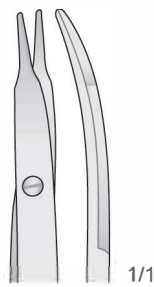

**SI-10451**

Stumpf Gebogen  
Blunt Curved  
Smussa Curva  
Romas Curvas  
Mousse Courbes

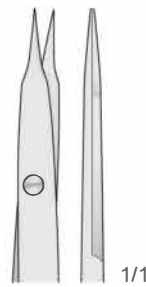

**SI-10452**

Spitz Gerade  
Sharp Straight  
Acuta Diritta  
Agudas Rectas  
Pointu Droites



**SI-10453**

Spitz Gebogen  
Sharp Curved  
Acuta Curva  
Agudas Curvas  
Pointu Courbes

**STEVENS**  
**SI-10454**  
110 mm

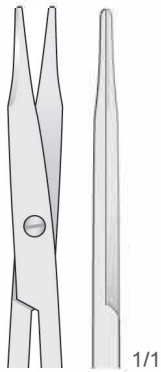

**SI-10455**  
150 mm

Gerade  
Straight  
Diritta  
Rectas  
Droites

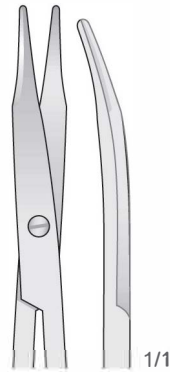

**SI-10456**  
150 mm

Gebogen  
Curved  
Curva  
Curvas  
Courbes

Stumpf  
Blunt  
Smussa  
Romas  
Mousse

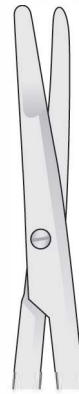

**SI-10457**  
120 mm

Gerade  
Straight  
Diritta  
Rectas  
Droites

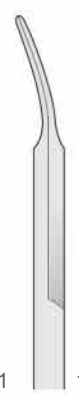

**SI-10457A**  
120 mm

Gebogen  
Curved  
Curva  
Curvas  
Courbes



**SI-10458**  
135 mm

Gerade  
Straight  
Diritta  
Rectas  
Droites



**SI-10459**  
135 mm

Gebogen  
Curved  
Curva  
Curvas  
Courbes



**KILNER**  
**SI-10461**

Stumpf  
Blunt  
Smussa  
Romas  
Mousse

**REYNOLDS**  
**SI-10460**





Scheren  
Scissors  
Forbici  
Tijeras  
Ciseaux

Gezahnt - Serrated  
Dentellata - Dentadas  
Dentelé

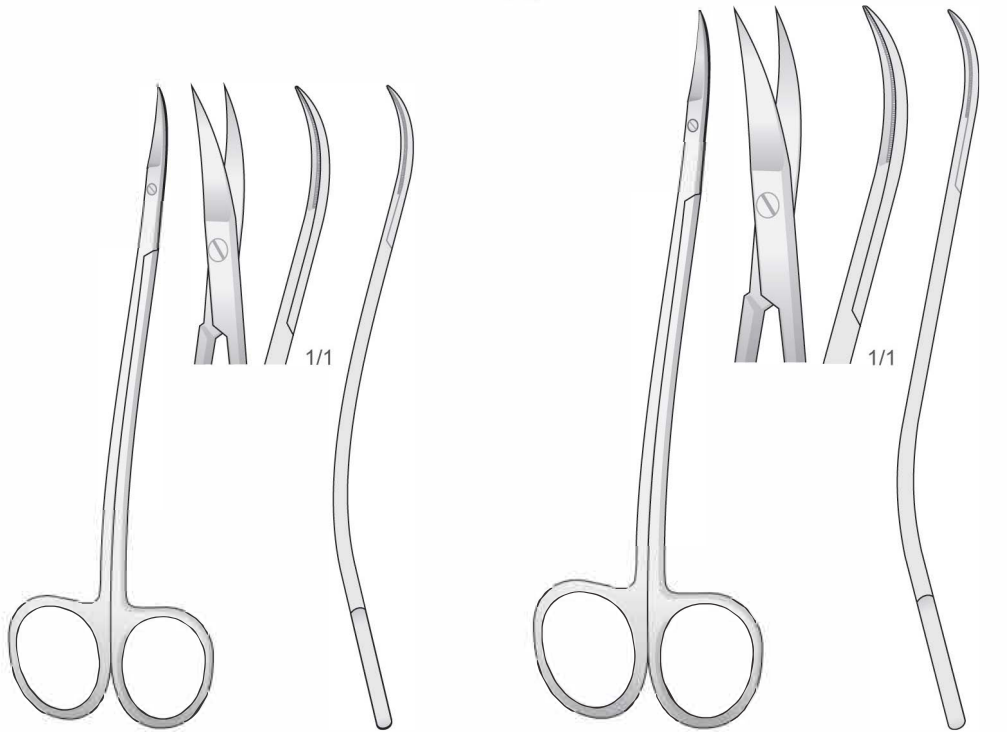

**LA GRANGE**  
**SI-10462**  
115 mm

**LA GANGE**  
**SI-10463**  
Gezahnt - Serrate  
Dentellata - Dentada 115 mm

Dentée

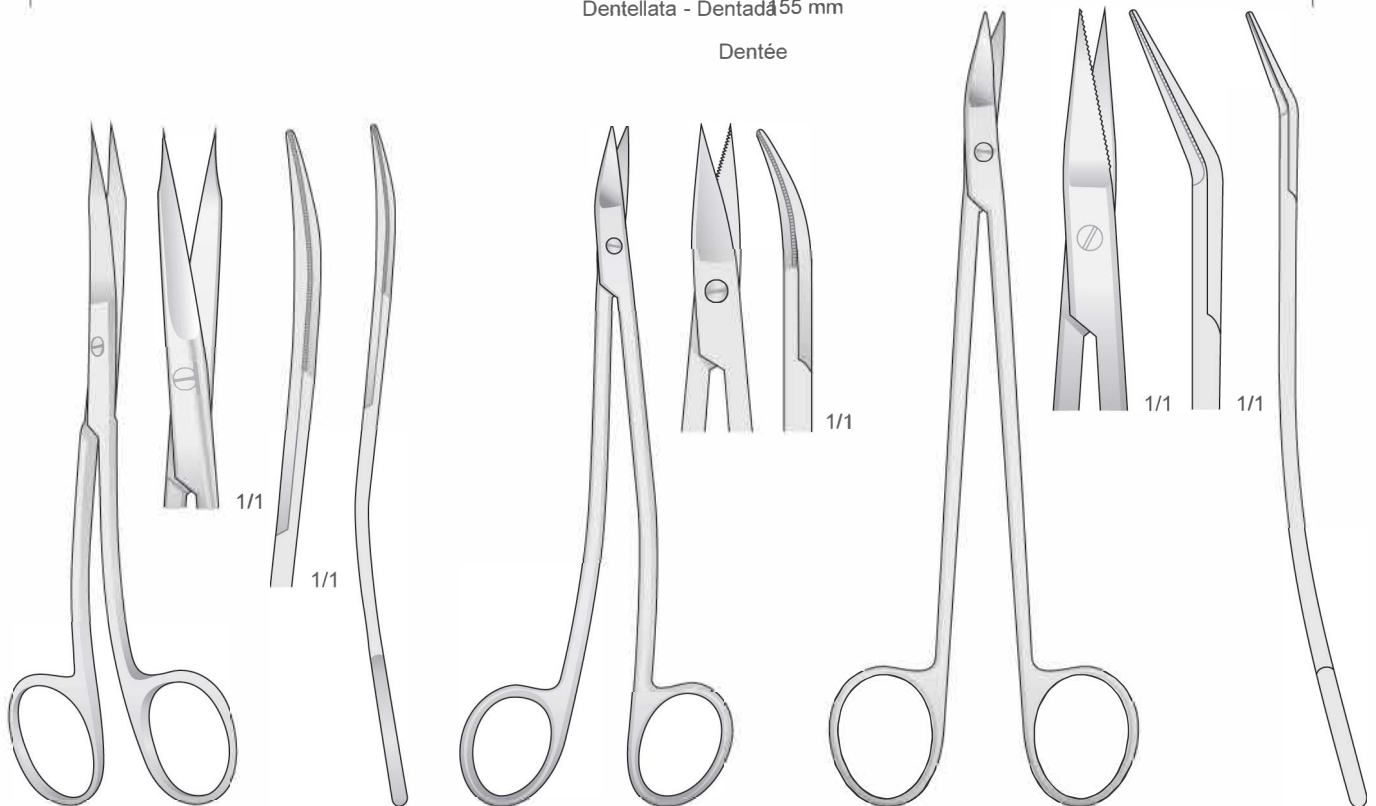

**GOLDMAN-FOX S**  
**FORM SI-10464**  
130 mm

**NEUMANN**  
**SI-10465**  
130 mm

**DEAN**  
**SI-10466**  
**DEAN**  
180 mm



Scheren  
Scissors  
Forbici  
Tijeras  
Ciseaux

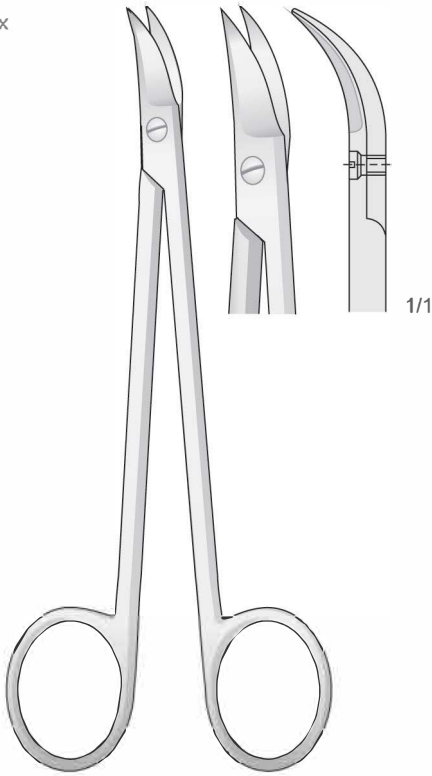

**QUINBY**  
**SI-10467**  
130 mm

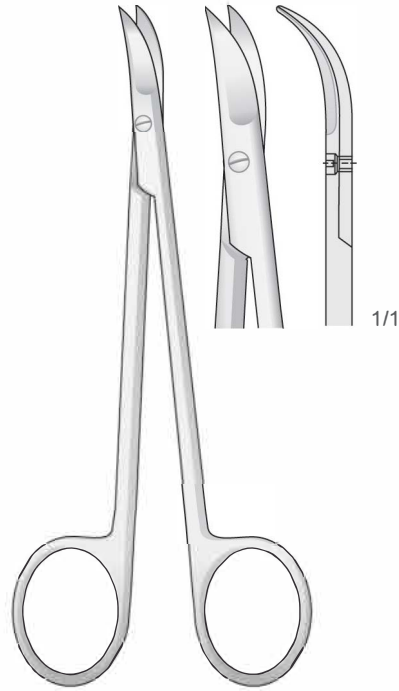

**CHADWICK**  
**SI-10468**  
115 mm

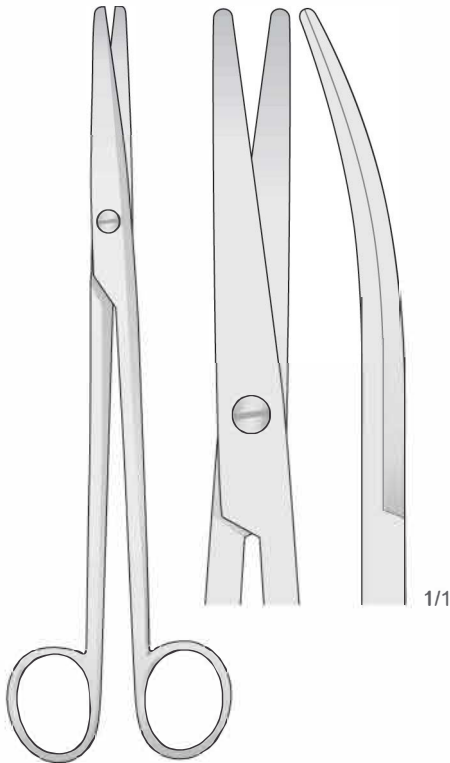

**MAYO-LEXER**  
**SI-10469**  
165 mm



**LEXER**  
**SI-10470**  
165 mm

Fein  
Delicate  
Fine  
Fins  
Finas

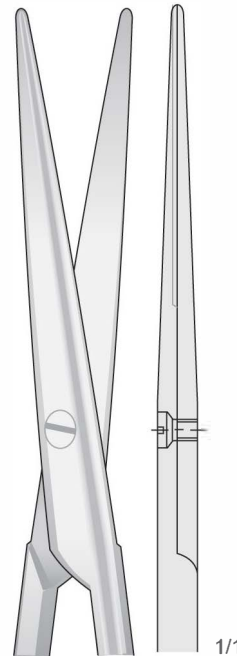

**SI-10471**

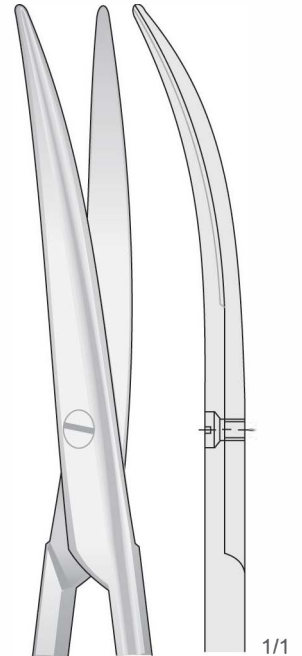

**SI-10472**



Scheren  
Scissors  
Forbici  
Tijeras  
Ciseaux

Stumpf  
Blunt  
Smusse  
Romas  
Mousses

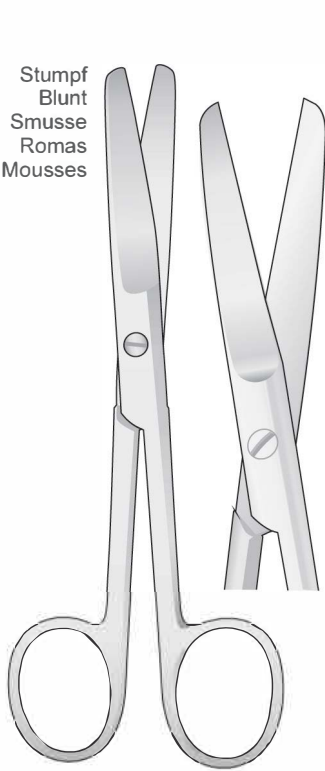

**SI-10473**  
145 mm

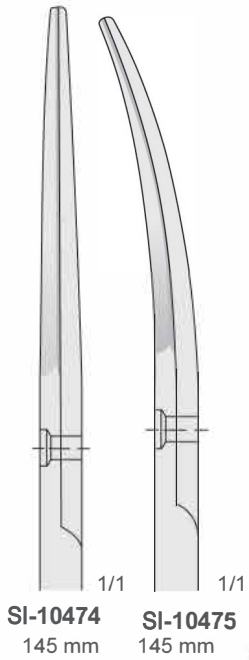

**SI-10474** 145 mm  
**SI-10475** 145 mm



**SI-10476**

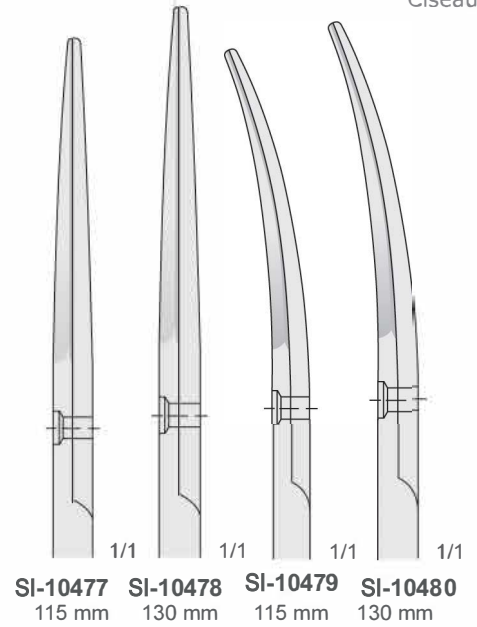

**SI-10477** 115 mm  
**SI-10478** 130 mm  
**SI-10479** 115 mm  
**SI-10480** 130 mm

Stumpf  
Blunt  
Smusse  
Romas  
Mousses

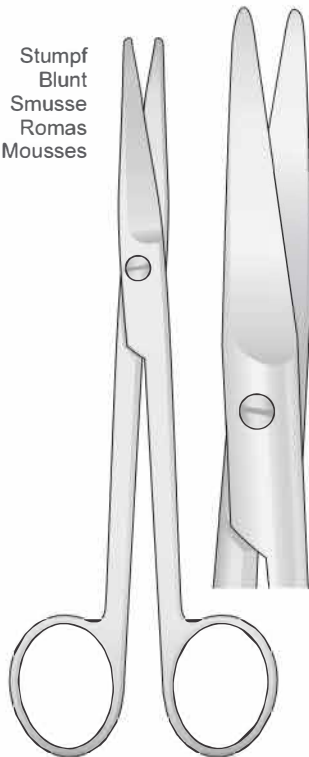

**MAYO**  
**SI-10477**  
140 mm

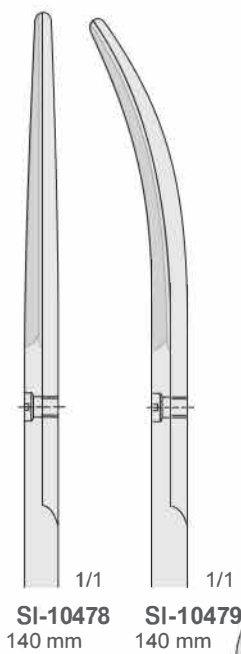

**SI-10478** 140 mm  
**SI-10479** 140 mm

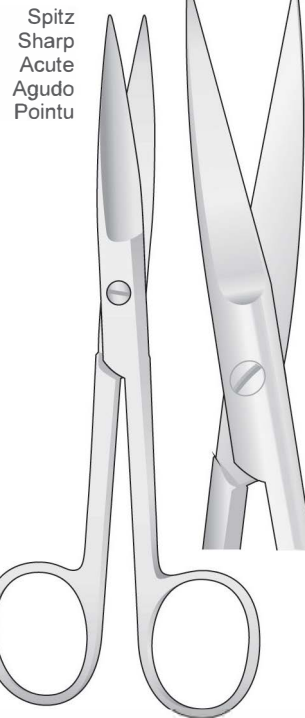

**SI-10484**

Spitz  
Sharp  
Acute  
Agudo  
Pointu



**SI-10480** 130 mm  
**SI-10481** 145 mm  
**SI-10482** 130 mm  
**SI-10483** 145 mm



Scheren  
Scissors  
Forbici  
Tijeras  
Ciseaux

### SUPER CUT

Regular  
Edge

**SUPER CUT  
Edge**

Super Cut Scissors have specially designed cutting edges.  
One regular edge and **one sharp-knife edge.**

**Extremely Sharp Razor Edge / Atraumatic**  
Extrem Scharfe Spitzer Beck / Atraumatische  
Tranchant extrêmement aiguisée / Atraumatique  
Borde extremadamente afilado / Atraumática  
Taglio estremamente affilato / Atraumatica

**One side serrated**  
Eine seite gezahnt  
Un côté dentelé  
Un lado dentado  
Un lato dentellato

Super Cut

**METZENBAUM**  
**SI-10491**  
180 mm

Super Cut

**SI-10485**  
180 mm

**SI-10486**  
180 mm

**SI-10487**  
125 mm

**SI-10488**  
125 mm

**METZENBAUM**  
**SI-10492**  
125 mm

Super Cut

**SI-10489**  
125 mm

**SI-10490**  
125 mm

**STEVENS**  
**SI-10493**  
125 mm



Scheren  
Scissors  
Forbici  
Tijeras  
Ciseaux

Fein  
Delicate  
Fine  
Finas  
Fins

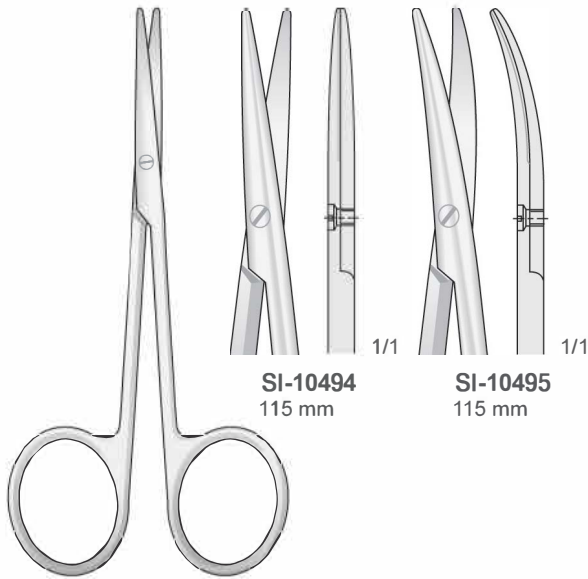

**SI-10494**  
115 mm

**SI-10495**  
115 mm

**BABY - METZENBAUM**  
**SI-10498**  
115 mm

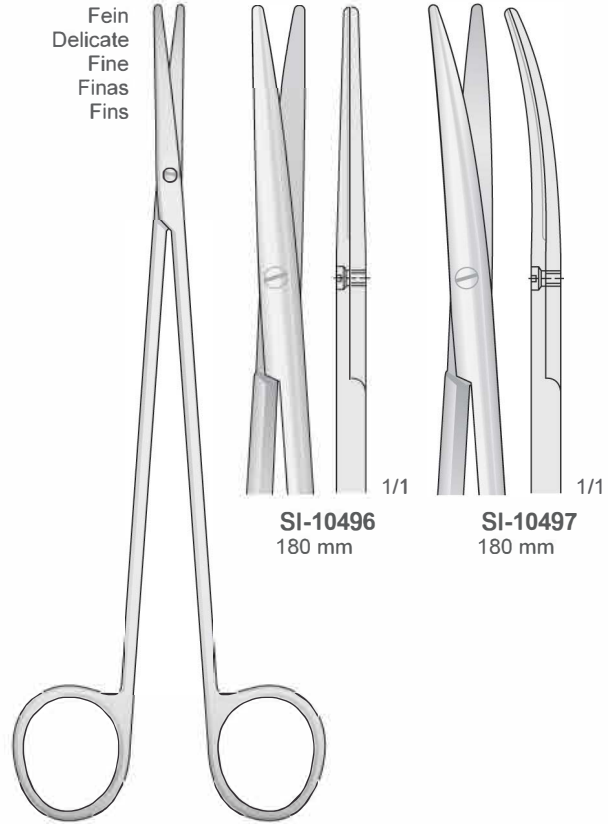

**SI-10496**  
180 mm

**SI-10497**  
180 mm

**TOENNIS-ADSON**  
**SI-10499**  
180 mm

Präparierscheren - Dissecting Scissors  
Forbici per dissezione - Tijeras de disección - Ciseaux à dissection

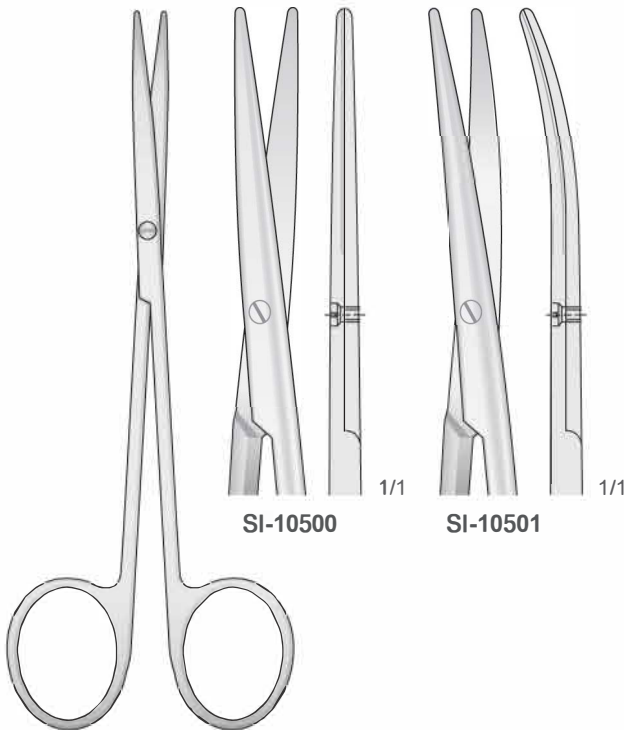

**SI-10500**

**SI-10501**

**METZENBAUM**  
**SI-10504**  
145 mm

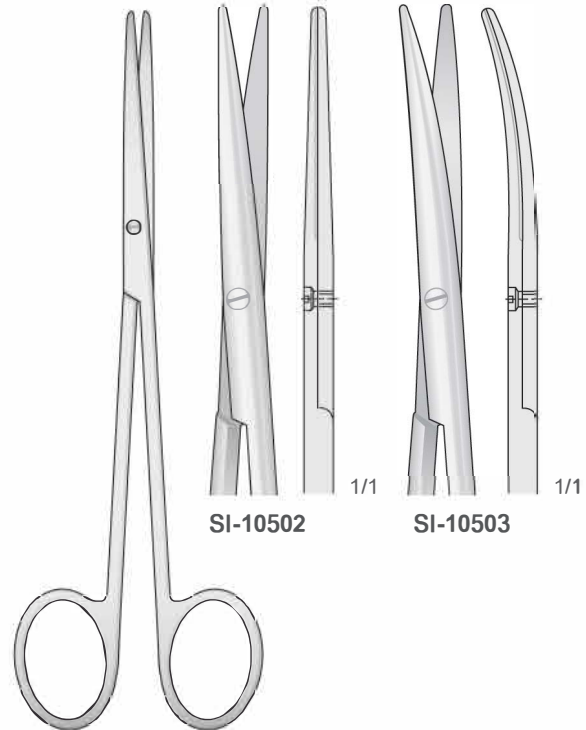

**SI-10502**

**SI-10503**

**METZENBAUM-FINO**  
**SI-10505**  
145 mm





Scheren  
Scissors  
Forbici  
Tijeras  
Ciseaux

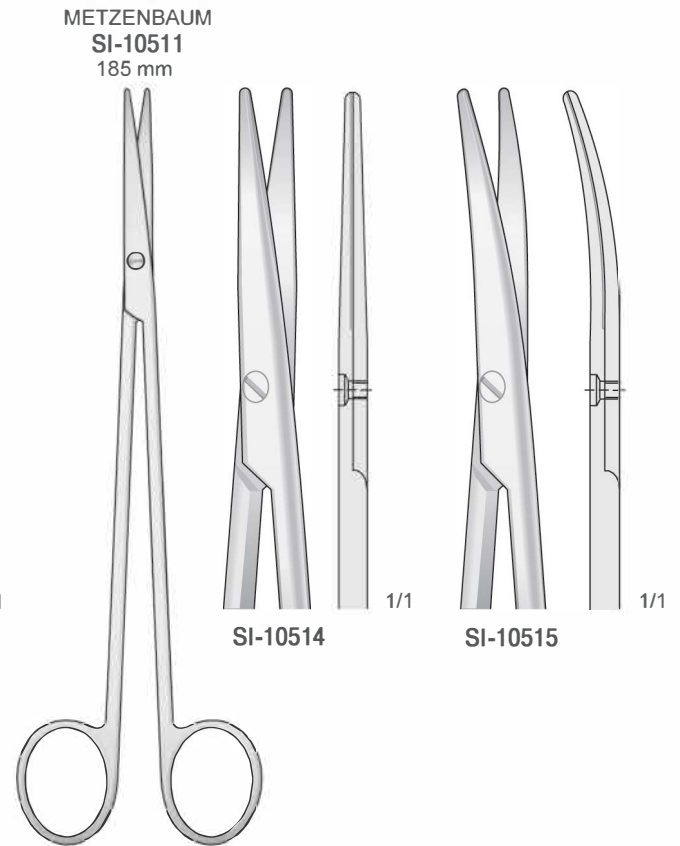
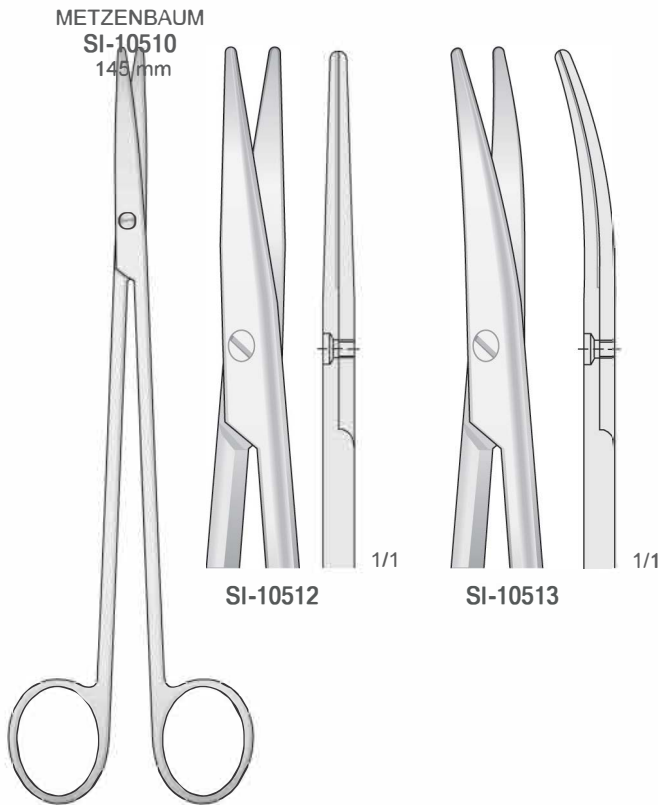
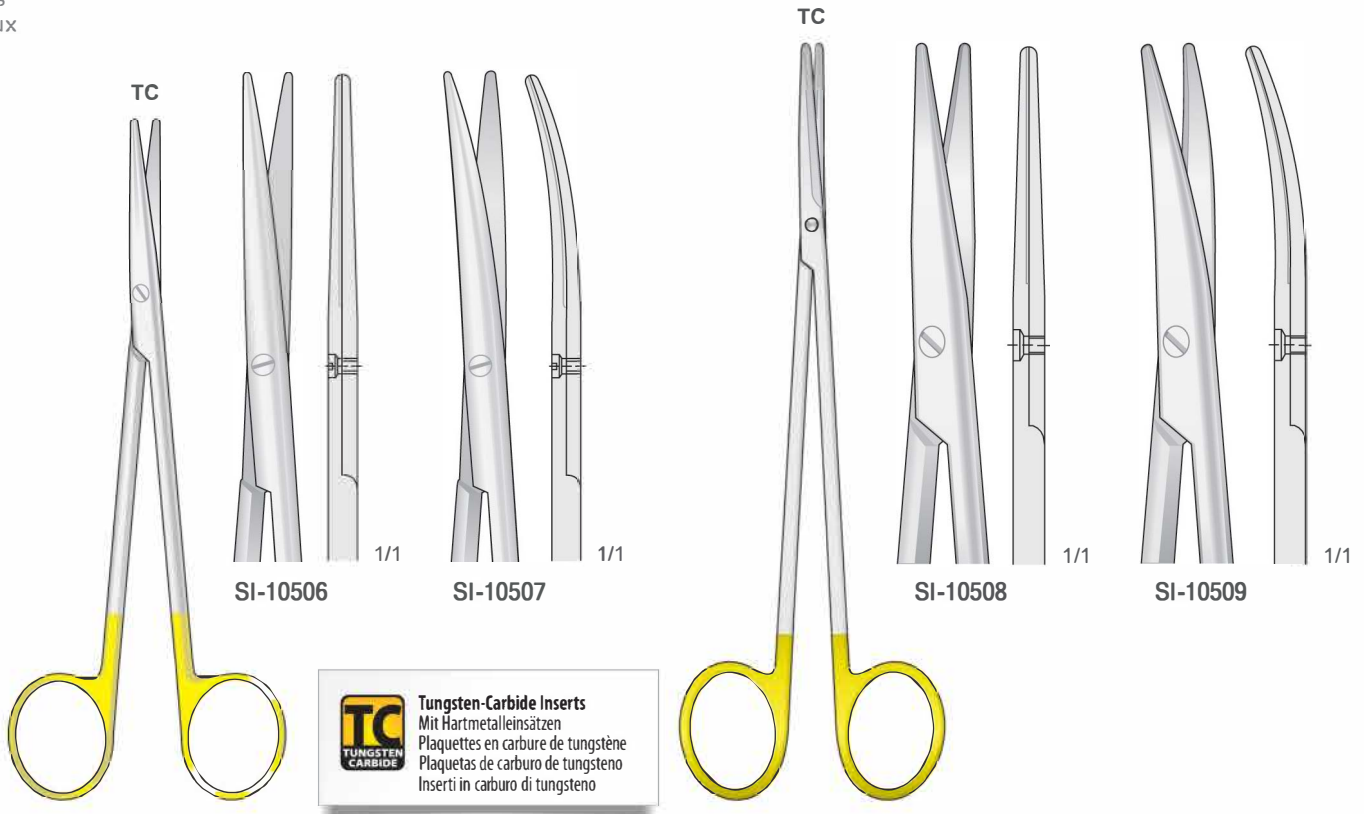

METZENBAUM  
SI-10516  
185 mm

185 mm  
METZENBAUM-FINO  
SI-10517





Scheren  
Scissors  
Forbici  
Tijeras  
Ciseaux

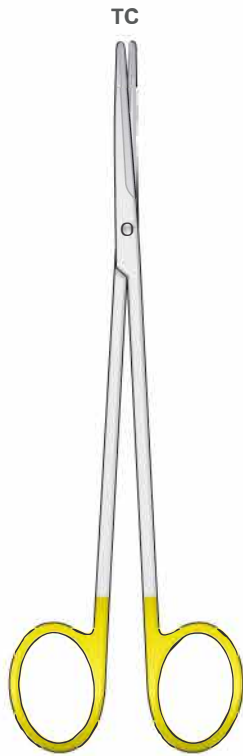

METZENBAUM-FINO  
SI-10522

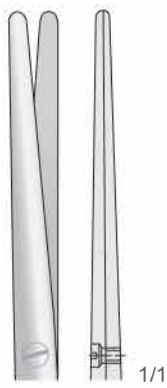

**SI-10518**  
140 mm

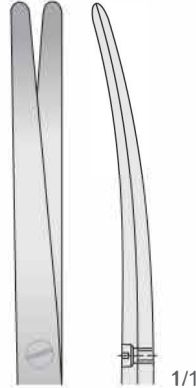

**SI-10519**  
140 mm

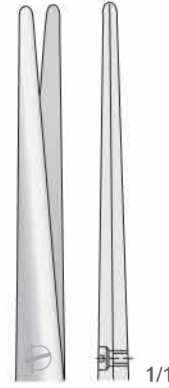

**SI-10520**  
180 mm

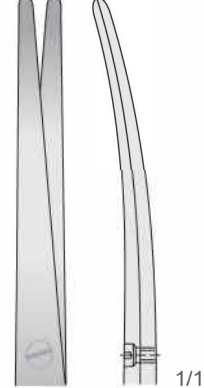

**SI-10521**  
180 mm



**Tungsten-Carbide Inserts**  
Mit Hartmetalleinsätzen  
Plaquettes en carbure de tungstène  
Plaquetas de carburo de tungsteno  
Inserti in carburo di tungsteno

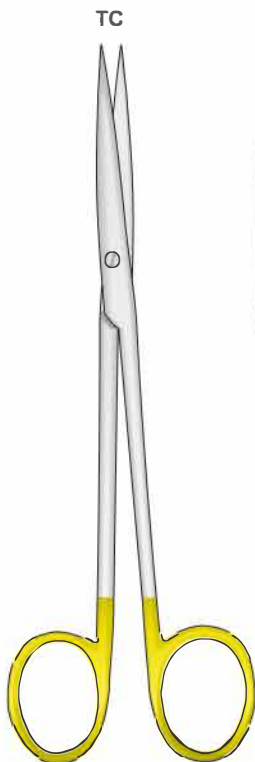

METZENBAUM-FINO  
SI-10527

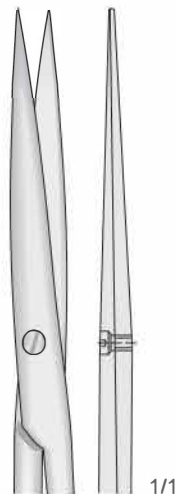

**SI-10523**  
140 mm

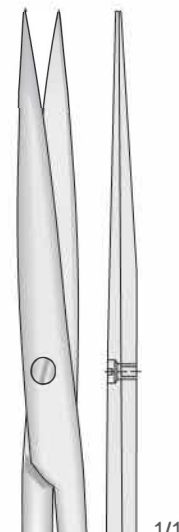

**SI-10524**  
180 mm

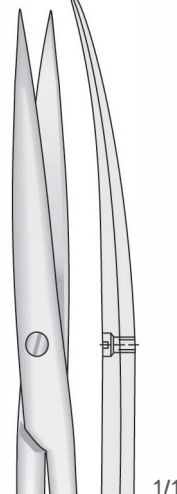

**SI-10525**  
140 mm



**SI-10526**  
180 mm



Scheren  
Scissors  
Forbici  
Tijeras  
Ciseaux



**Tungsten-Carbide Inserts**  
Mit Hartmetalleinsätzen  
Plaquettes en carbure de tungstène  
Plaquetas de carburo de tungsteno  
Inserti in carburo di tungsteno

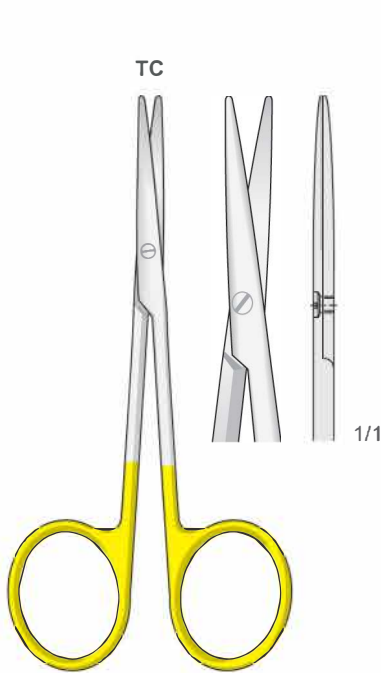

LEXER-BABY (KNAPP)  
**SI-10528**  
115 mm

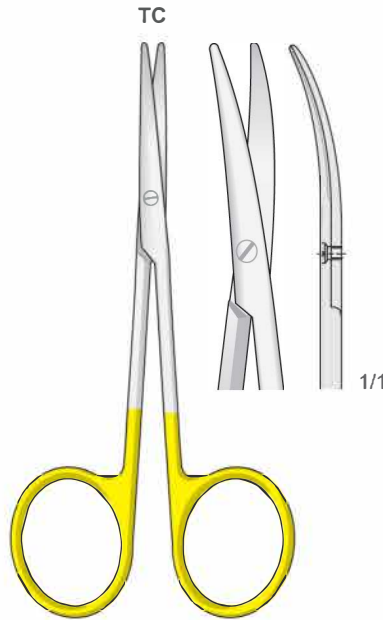

LEXER-BABY (KNAPP)  
**SI-10529**  
115 mm

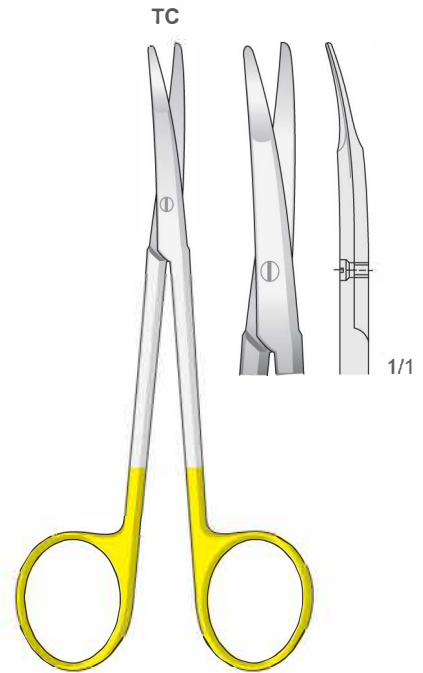

KILNER  
**SI-10530**  
125 mm

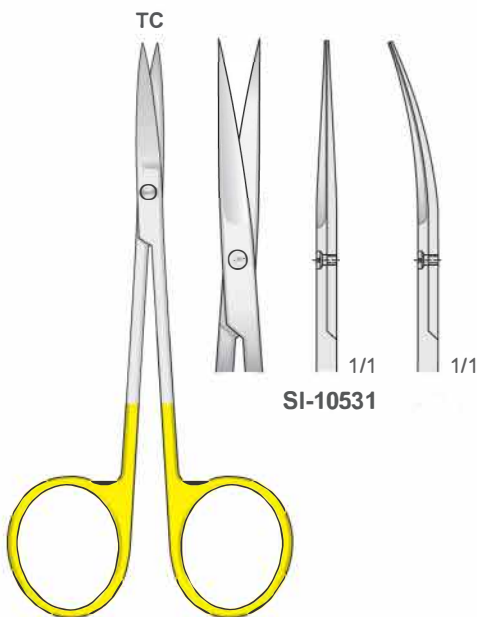

**SI-10534**  
115 mm

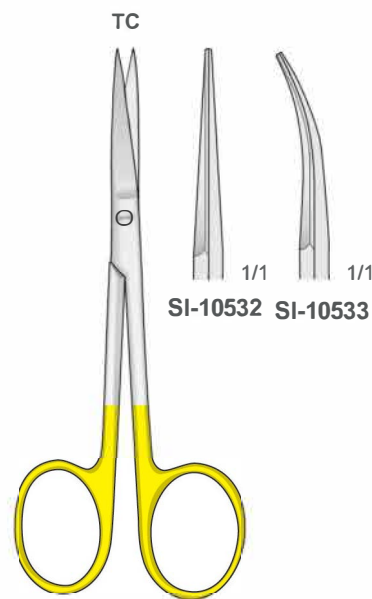

**SI-10535**  
110 mm

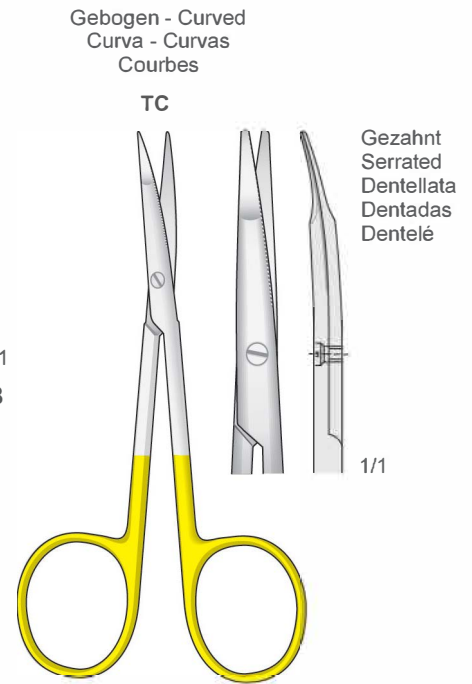

GREENBERG-PAR  
**SI-10536**  
115 mm



Scheren  
Scissors  
Forbici  
Tijeras  
Ciseaux



TC

1/1

Gezahnt  
Serrated  
Dentellate  
Dentadas  
Dentelé

SI-10537  
160 mm  
Super Cut

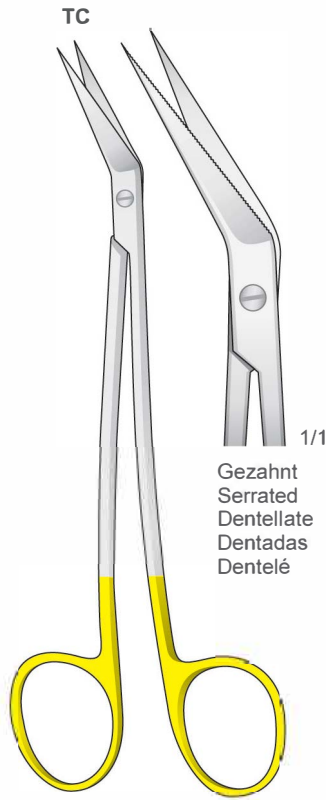

TC

1/1

Gezahnt  
Serrated  
Dentellate  
Dentadas  
Dentelé

SI-10538  
160 mm

**Tungsten-Carbide Inserts**  
Mit Hartmetalleinsätzen  
Plaquettes en carbure de tungstène  
Plaquetas de carburo de tungsteno  
Inserti in carburo di tungsteno

Eine Schneide gezahnt S-förmig gebogen  
One toothed cutting edge S-shaped  
Una lama dentata curva a forma S  
Una hoja dentada forma S  
Une lame dentelée courbés en S

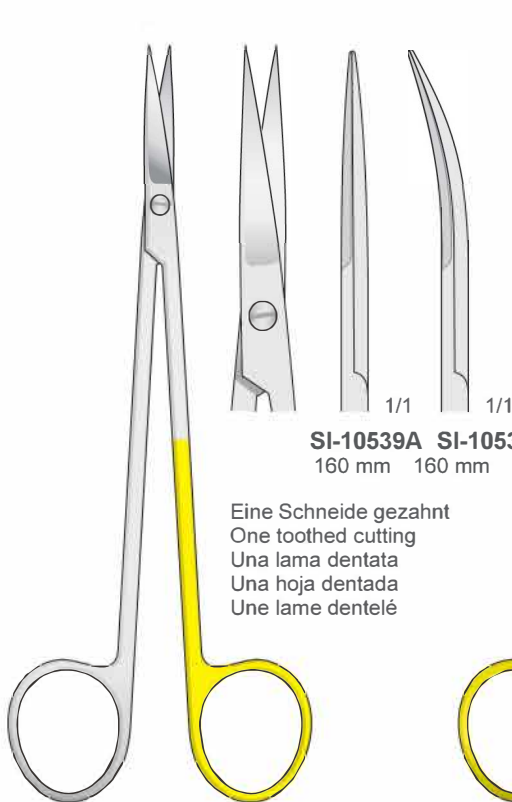

SI-10539A SI-10539B  
160 mm 160 mm

Eine Schneide gezahnt  
One toothed cutting  
Una lama dentata  
Una hoja dentada  
Une lame dentelé

KELLY  
SI-10539  
160 mm

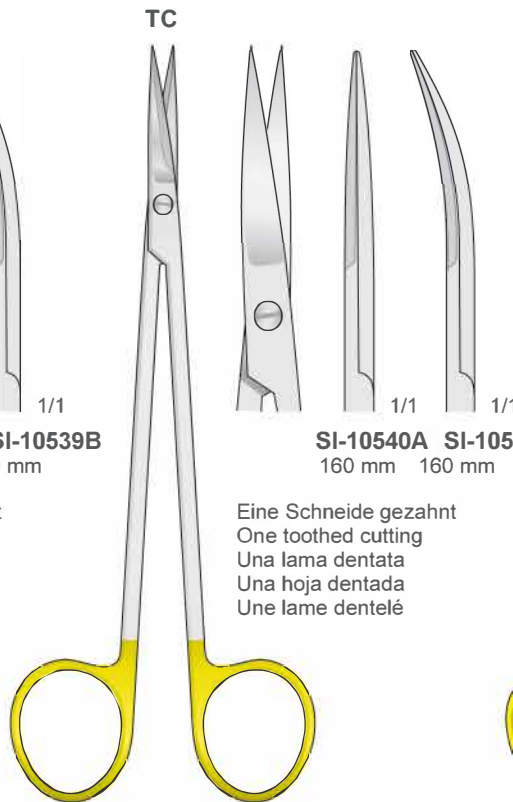

TC

1/1 1/1

SI-10540A SI-10540B  
160 mm 160 mm

Eine Schneide gezahnt  
One toothed cutting  
Una lama dentata  
Una hoja dentada  
Une lame dentelé

KELLY  
SI-10540  
160 mm

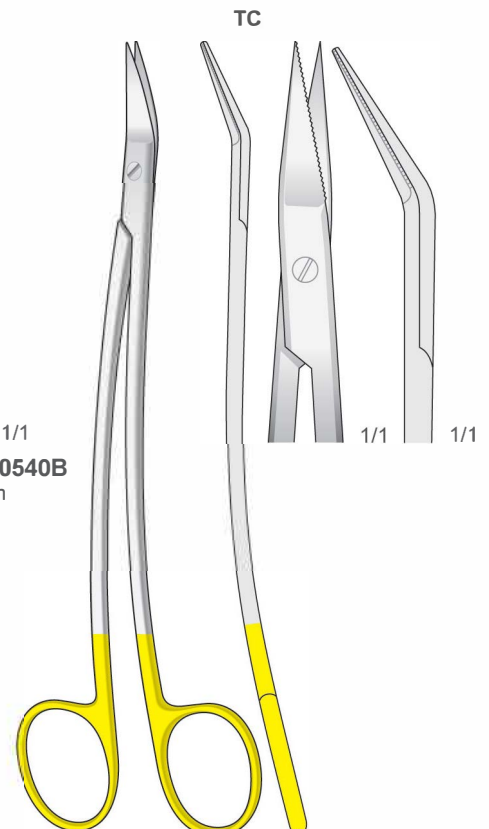

TC

1/1 1/1

SI-10541  
175 mm



Scheren  
Scissors  
Forbici  
Tijeras  
Ciseaux

Wellenschliff  
TC

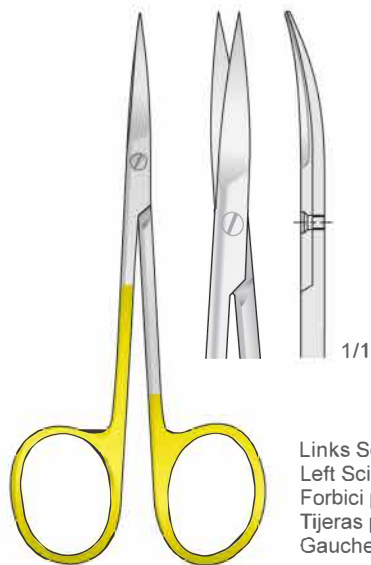

Links Scheren  
Left Scissors  
Forbici per mancini  
Tijeras para zurdos  
Gauche Ciseaux



**Tungsten-Carbide Inserts**  
Mit Hartmetalleinsätzen  
Plaquettes en carbure de tungstène  
Plaquetas de carburo de tungsteno  
Inserti in carburo di tungsteno

IRIS  
SI-10541A  
110 mm

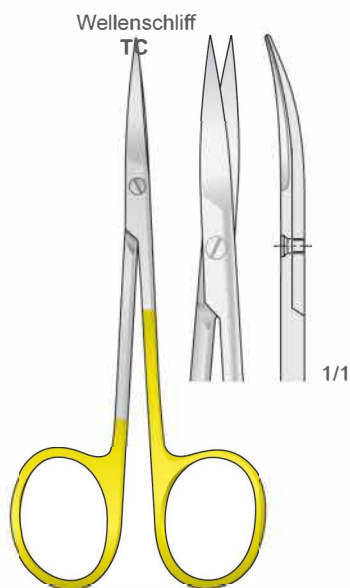

IRIS  
SI-10542  
110 mm

Wellenschliff  
TC

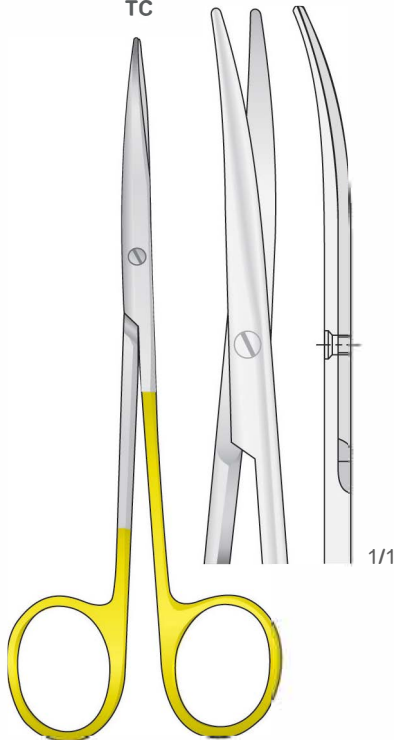

METZENBAUM  
SI-10543  
145 mm

Wellenschliff  
TC

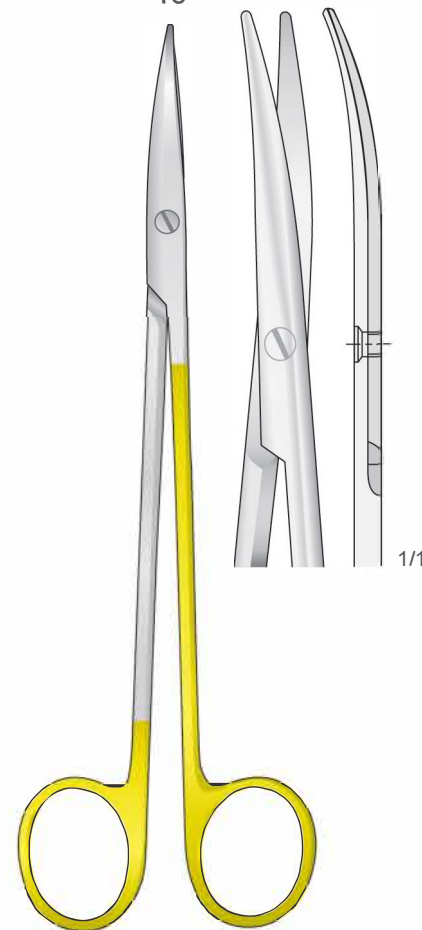

METZENBAUM  
SI-10544  
185 mm



Scheren  
Scissors  
Forbici  
Tijeras  
Ciseaux



**Extremely Sharp Razor Edge / Atraumatic**  
Extrem Scharfe Spitzer Beck / Atraumatische  
Tranchant extrêmement aiguisée / Atraumatique  
Borde extremadamente afilado / Atraumática  
Taglio estremamente affilato / Atraumatica

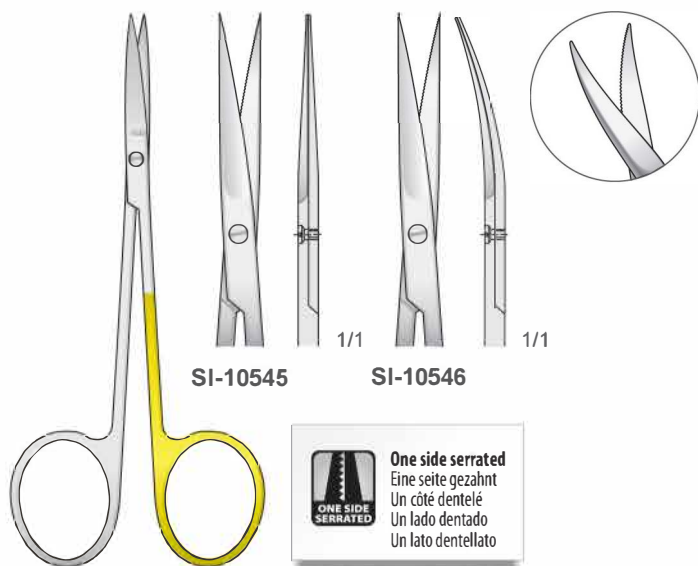

SI-10545

SI-10546



**One side serrated**  
Eine seite gezahnt  
Un côté dentelé  
Un lado dentado  
Un lato dentellato

SI-10547  
110 mm

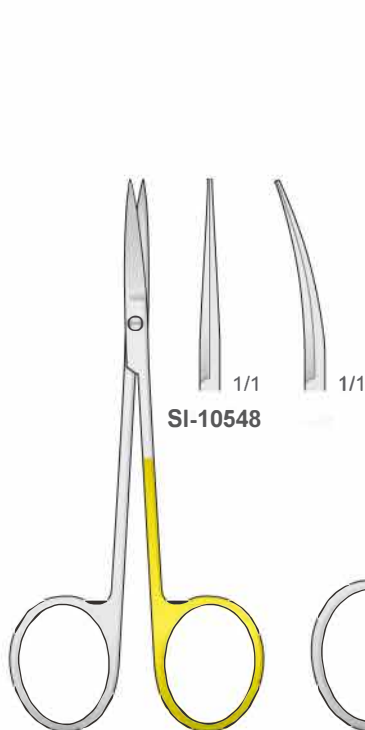

SI-10548

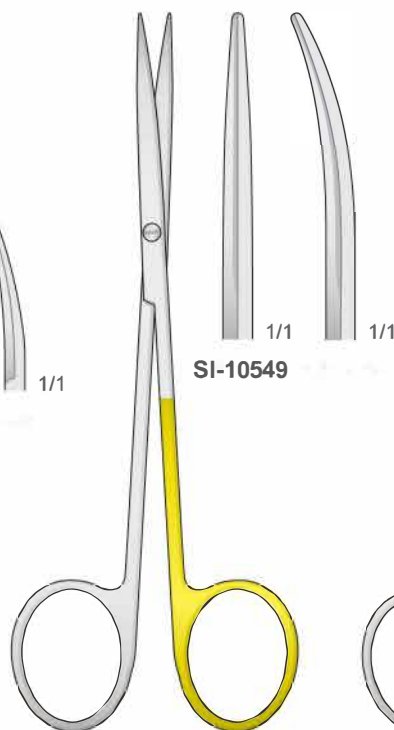

SI-10549

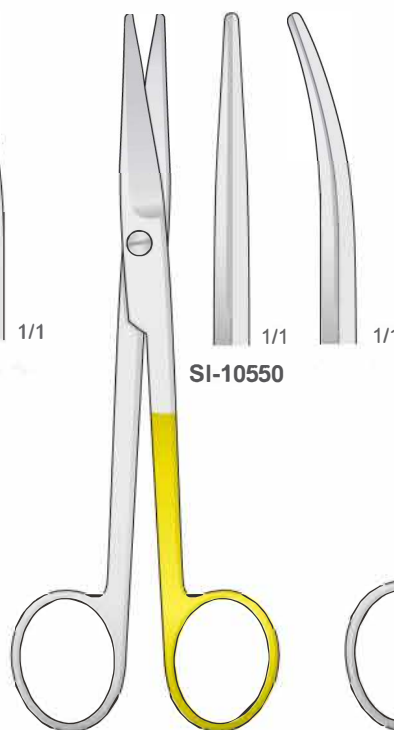

SI-10550

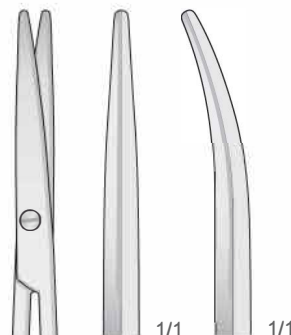

SI-10551

IRIS  
SI-10552  
110 mm

METZENBAUM  
SI-10553  
145 mm

MAYO  
SI-10554  
140 mm

METZENBAUM  
SI-10555  
185 mm





Scheren  
Scissors  
Forbici  
Tijeras  
Ciseaux

**SUPER CUT**

Regular  
Edge

**SUPER CUT**  
Edge

Super Cut Scissors have specially designed cutting edges.  
One regular edge and **one sharp-knife edge**.

**Extremely Sharp Razor Edge / Atraumatic**  
Extrem Scharfe Spitzer Beck / Atraumatische  
Tranchant extrêmement aiguisée / Atraumatique  
Borde extremadamente afilado / Atraumática  
Taglio estremamente affilato / Atraumatica

**One side serrated**  
Eine seite gezahnt  
Un côté dentelé  
Un lado dentado  
Un lato dentellato

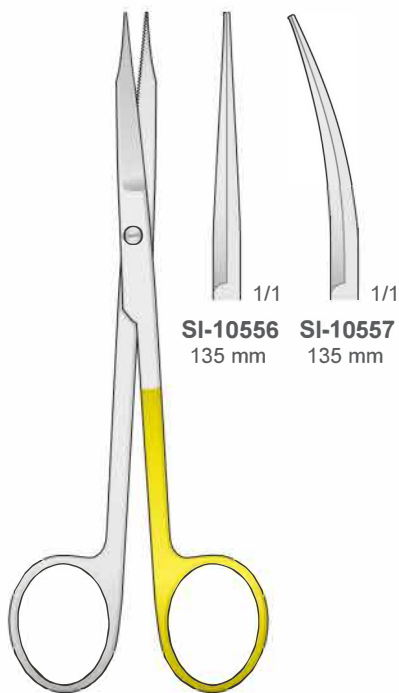

**GOLDMAN-FOX**  
**SI-10558**  
135 mm

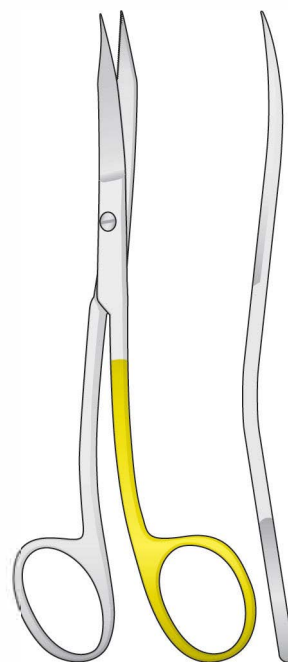

**GOLDMAN-FOX S FORM**  
**SI-10559**  
130 mm

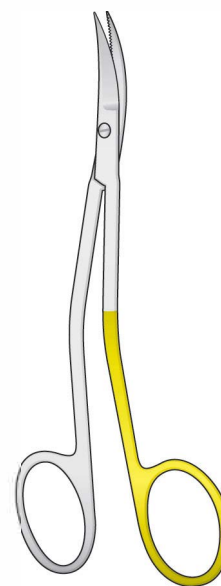

**LA GRANGE**  
**SI-10560**  
115 mm

Spitz  
Sharp  
Acute  
Agudas  
Pointu

Stumpf  
Blunt  
Smusse  
Romas  
Mousse

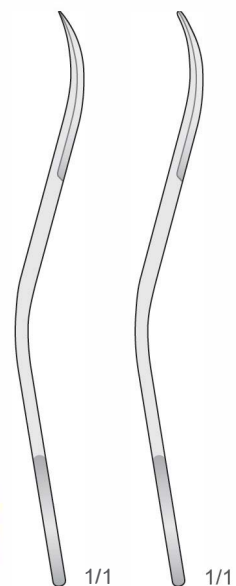

**LA GRANGE LA GRANGE**  
**SI-10561**





Scheren  
Scissors  
Forbici  
Tijeras  
Ciseaux

TC

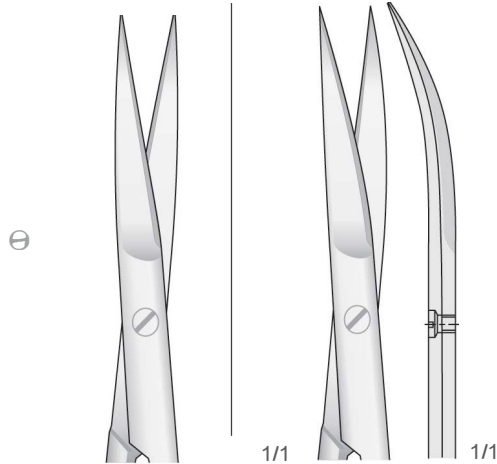

**SI-10562**  
150 mm

**SI-10563**  
150 mm

**Tungsten-Carbide Inserts**  
Mit Hartmetalleinsätzen  
Plaquettes en carbure de tungstène  
Plaquetas de carburo de tungsteno  
Inserti in carburo di tungsteno

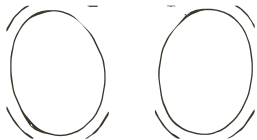

**JOSEPH**  
**SI-10564**  
150 mm

**One side serrated**  
Eine seite gezahnt  
Un côté dentelé  
Un lado dentado  
Un lato dentellato

**One side serrated**  
Eine seite gezahnt  
Un côté dentelé  
Un lado dentado  
Un lato dentellato

TC

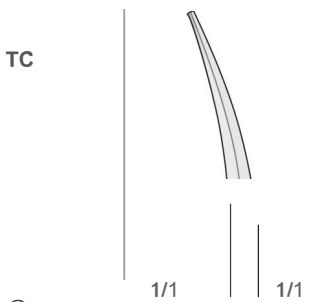

**SI-10565** **SI-10565A**

Gezahnt - Serrated  
Dentellata - Dentadas  
Dentelé

TC

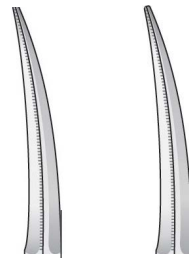

**SI-10566**

Spitz  
Sharp  
Acuta  
Aguda  
Pointu



**SI-10567**

Stumpf  
Blunt  
Smussa  
Romas  
Mousse

TC



1/1

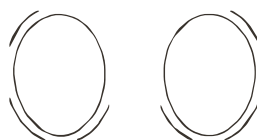

**GOLDMAN-FOX**  
**SI-10567A**  
135 mm

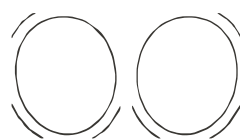

**PECK-JOSEPH**  
**SI-10568**  
140 mm

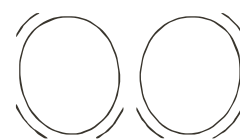

**GREGORY**  
**SI-10569**  
140 mm



Scheren  
Scissors  
Forbici  
Tijeras  
Ciseaux

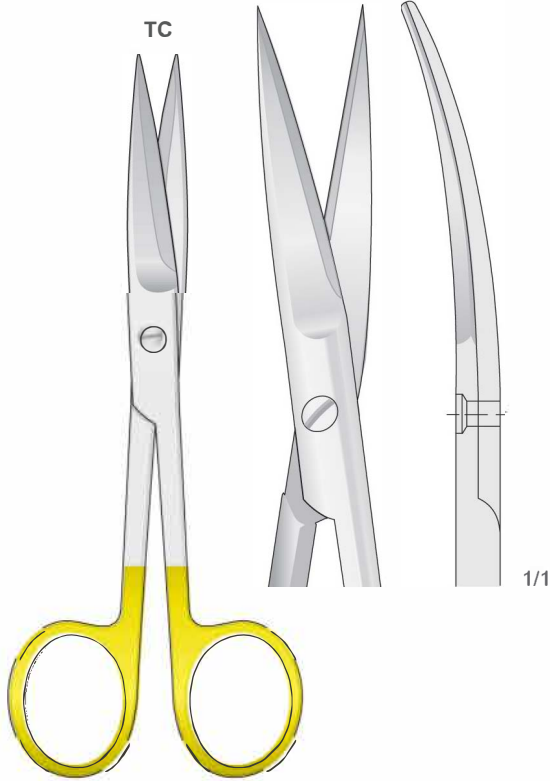

SI-105 70  
145 mm

**TC**  
TUNGSTEN  
CARBIDE

**Tungsten-Carbide Inserts**  
Mit Hartmetalleinsätzen  
Plaquettes en carbure de tungstène  
Plaquetas de carburo de tungsteno  
Inserti in carburo di tungsteno

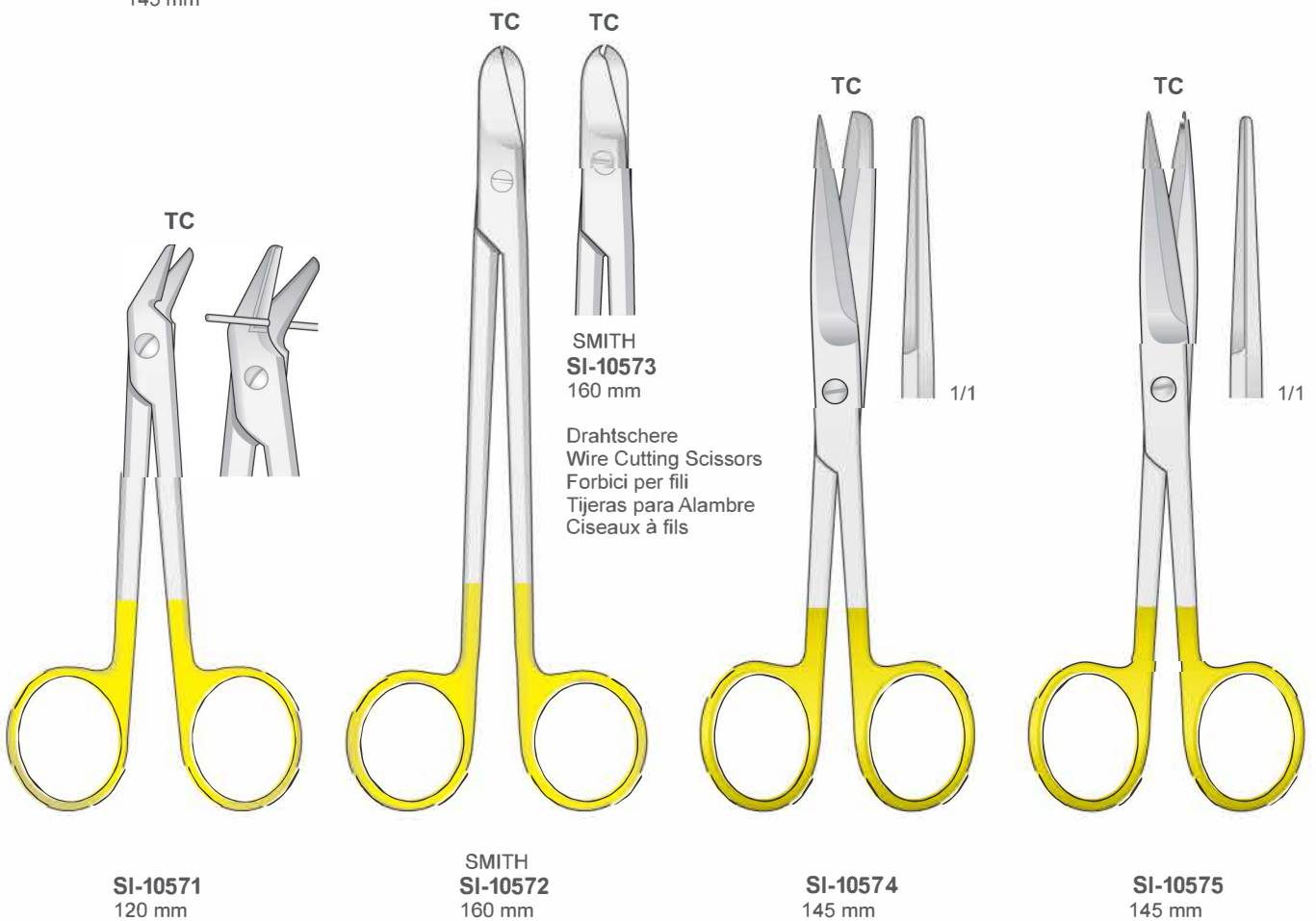

SI-10571  
120 mm

SMITH  
SI-10572  
160 mm

SI-10574  
145 mm

SI-10575  
145 mm

SMITH  
SI-10573  
160 mm

Drahtschere  
Wire Cutting Scissors  
Forbici per fili  
Tijeras para Alambre  
Ciseaux à fils



Mikro Pinzetten  
Delicate Forceps  
Micro Pinzette  
Pinzas finas  
Micro Pincers

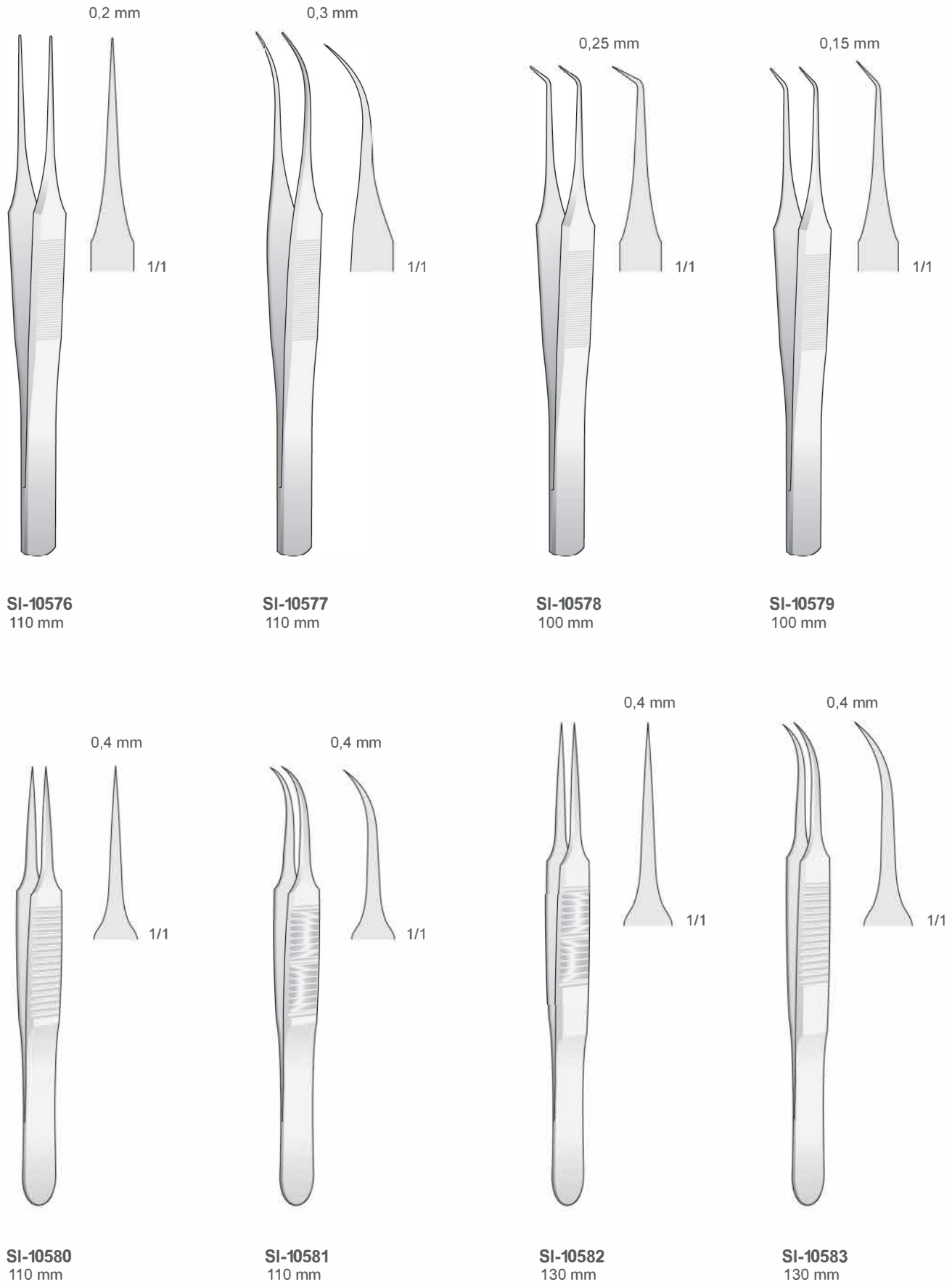



Delicate Forceps  
Micro Pinzette  
Pinzas finas  
Micro Pincas



Tissue Forceps  
1x2 Teeth

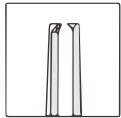

**BISHOP-HARMON**  
**SI-10584** 1,2  
mm 85 mm

Dressing Forceps  
criss-cross serrated tips

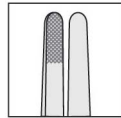

**BISHOP-HARMO**  
**N SI-10585** 1,2  
mm 85 mm

9



1/1  
1x2 Zähne  
1x2 Teeth  
1x2 Denti  
1x2 Dientes  
1x2 Dents



**CASTROVIEJO**  
**SI-10586** 0.9  
mm 120 mm



1/1  
9x9 Zähne  
9x9 Teeth  
9x9 Denti  
9x9 Dientes  
9x9 Dents



**BROWN**  
**SI-10587**  
120 mm

1,2 mm

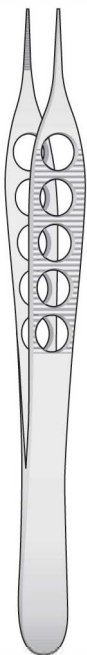

**ADSON**  
**SI-10588**  
120 mm

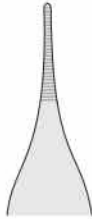

1/1

1,2 mm

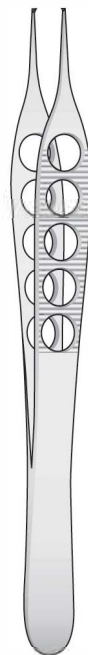

**ADSON**  
**SI-10589**  
120 mm



1/1

7

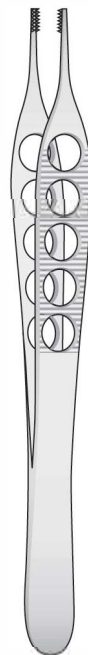

**ADSON-BROWN**  
**SI-10590**  
120 mm

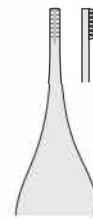

1/1

7x7 Zähne  
7x7 Teeth  
7x7 Denti  
7x7 Dientes  
7x7 Dents

TC



**ADSON-BROWN**  
**SI-10591**  
120 mm

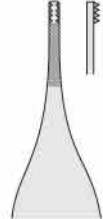

1/1



Mikro Pinzetten  
Delicate Forceps  
Micro Pinzette  
Pinzas finas  
Micro Pincers

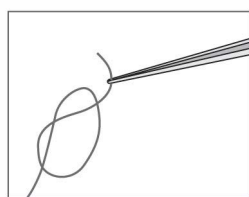

**SI-10598**  
120 mm

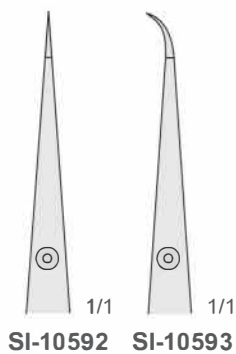

**SI-10592** 1/1 **SI-10593** 1/1



**SI-10599**  
150 mm

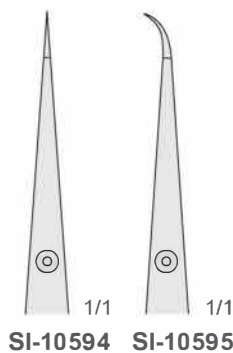

**SI-10594** 1/1 **SI-10595** 1/1

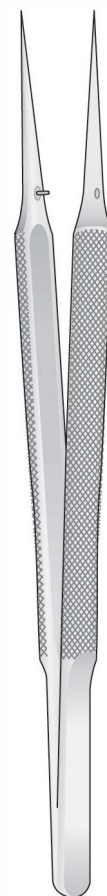

**SI-10600**  
180 mm

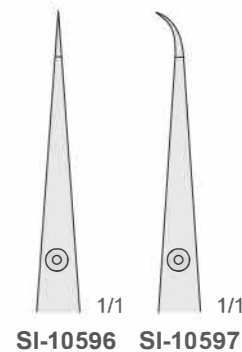

**SI-10596** 1/1 **SI-10597** 1/1



Mikro Pinzetten  
Micro Forceps  
Micro Pinzette  
Micro Pinzas  
Micro Pincers

Mikro Pinzette - Rundgriff Ø 8 mm  
Mit Führungsstift diamantiert  
Fadenplatte 6x0,7 mm

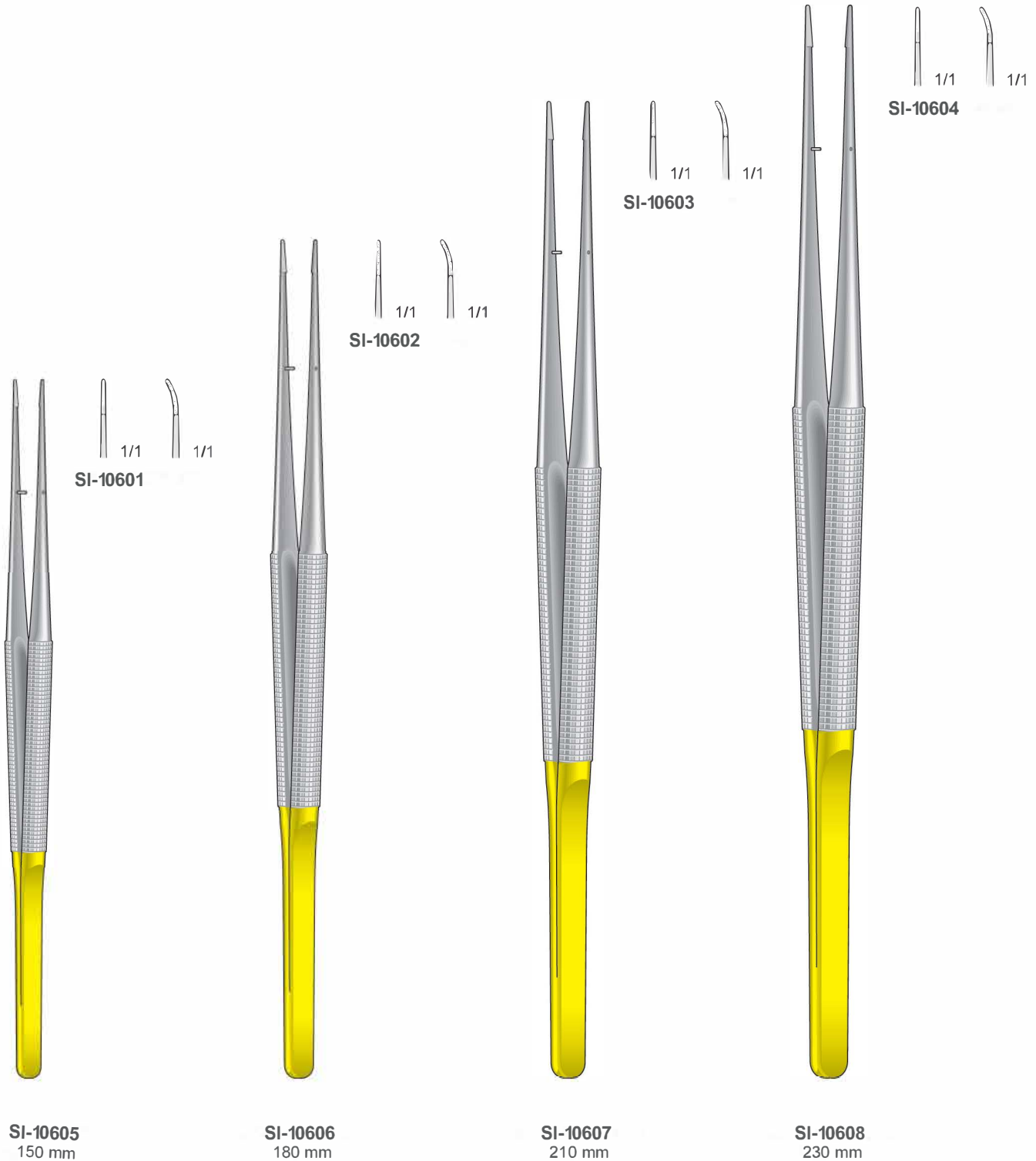

**SI-10605**  
150 mm

**SI-10606**  
180 mm

**SI-10607**  
210 mm

**SI-10608**  
230 mm









Mikro Pinzetten  
 Micro Forceps  
 Micro Pinzette  
 Micro Pinzas  
 Micro Pincers

Mikro Pinzette - Rundgriff Ø 8 mm  
 Mit Führungsstift diamantiert  
 Fadenplatte 6x0,7 mm



**Diamond Tip**  
 Diamantiert  
 Punta diamantata  
 Punta de diamante  
 Pointe de diamant

<p>1x2 Zähne 1x2 Teeths 1x2 Denti 1x2 Dientes 1x2 Dents</p>  <p><b>SI-10609</b></p>	<p>1x2 Zähne 1x2 Teeths 1x2 Denti 1x2 Dientes 1x2 Dents</p>  <p><b>SI-10610</b></p>	<p>1x2 Zähne 1x2 Teeths 1x2 Denti 1x2 Dientes 1x2 Dents</p>  <p><b>SI-10611</b></p>	<p>1x2 Zähne 1x2 Teeths 1x2 Denti 1x2 Dientes 1x2 Dents</p>  <p><b>SI-10612</b></p>
<p><b>SI-10613</b> 150 mm</p>	<p><b>SI-10614</b> 180 mm</p>	<p><b>SI-10615</b> 210 mm</p>	<p><b>SI-10616</b> 230 mm</p>



Titan-Pinzetten  
Titanium Tissue Forceps  
Pinzette in titanio  
Pinzas de titanio  
Pincas en titane

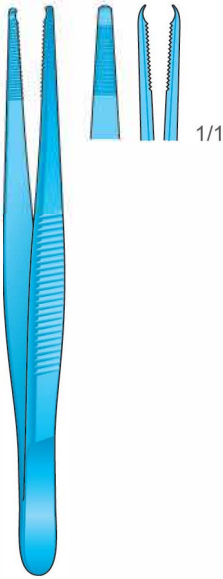

**SI-10617**  
90 mm



**SI-10618**  
130 mm

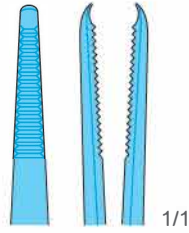

ADSON  
**SI-10619**  
120 mm

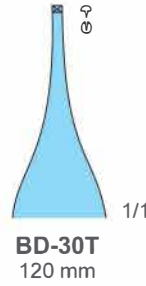

ADSON  
**SI-10620**  
120 mm

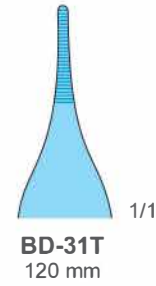

**SI-10621**  
130 mm

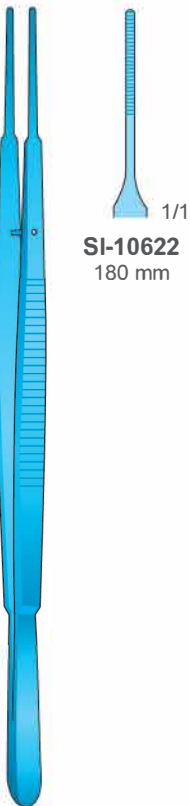

GERALD  
**SI-10626**  
180 mm



**SI-10623**  
180 mm



DE BAKEY  
**SI-10627**



**SI-10624**  
160 mm



**SI-10625**  
160 mm



COLLEGE  
**SI-10628**  
150 mm

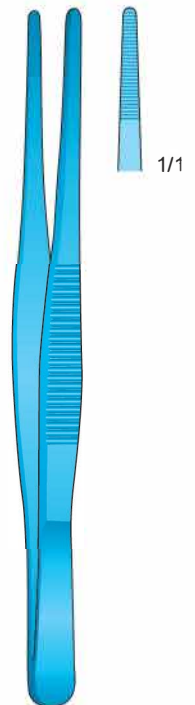

**SI-10629**  
145 mm



Mikro Pinzetten  
Delicate Forceps  
Micro Pinzette  
Pinzas finas  
Micro Pincas

Rund-Griffe Ø 8 mm  
Round handle Ø 8 mm  
Manico rotondo Ø 8 mm  
Mango redondo Ø 8 mm  
Manche rond Ø 8 mm

Ø 1 mm



**SI-10630** - 150 mm  
**SI-10631** - 180 mm  
**SI-10632** 210 mm

Ø 2 mm



**SI-10633** - 150 mm  
**SI-10634** - 180 mm  
**SI-10635** - 210 mm

Titan  
Titanium  
Titanio  
Titane

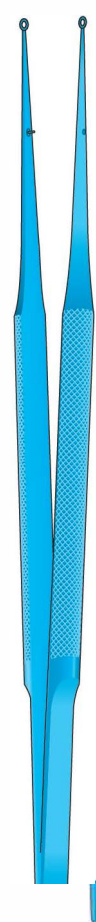

**SI -10640A** - 150 mm  
**SI -10640B** - 180 mm  
**SI -10640C** - 210 mm

Ø 1 mm



**SI-10636** - 150 mm  
**SI-10637** - 180 mm  
**SI-10638** - 210 mm

Ø 2 mm



**SI-10636** - 150 mm  
**SI-10637** - 180 mm  
**SI-10638** - 210 mm



SI-10639

SI-10640



Zahnpinzetten  
Cotton and Dressing Pliers  
Pinzette per medicazione  
Pinzas para vendajes  
Précettes pour cotton

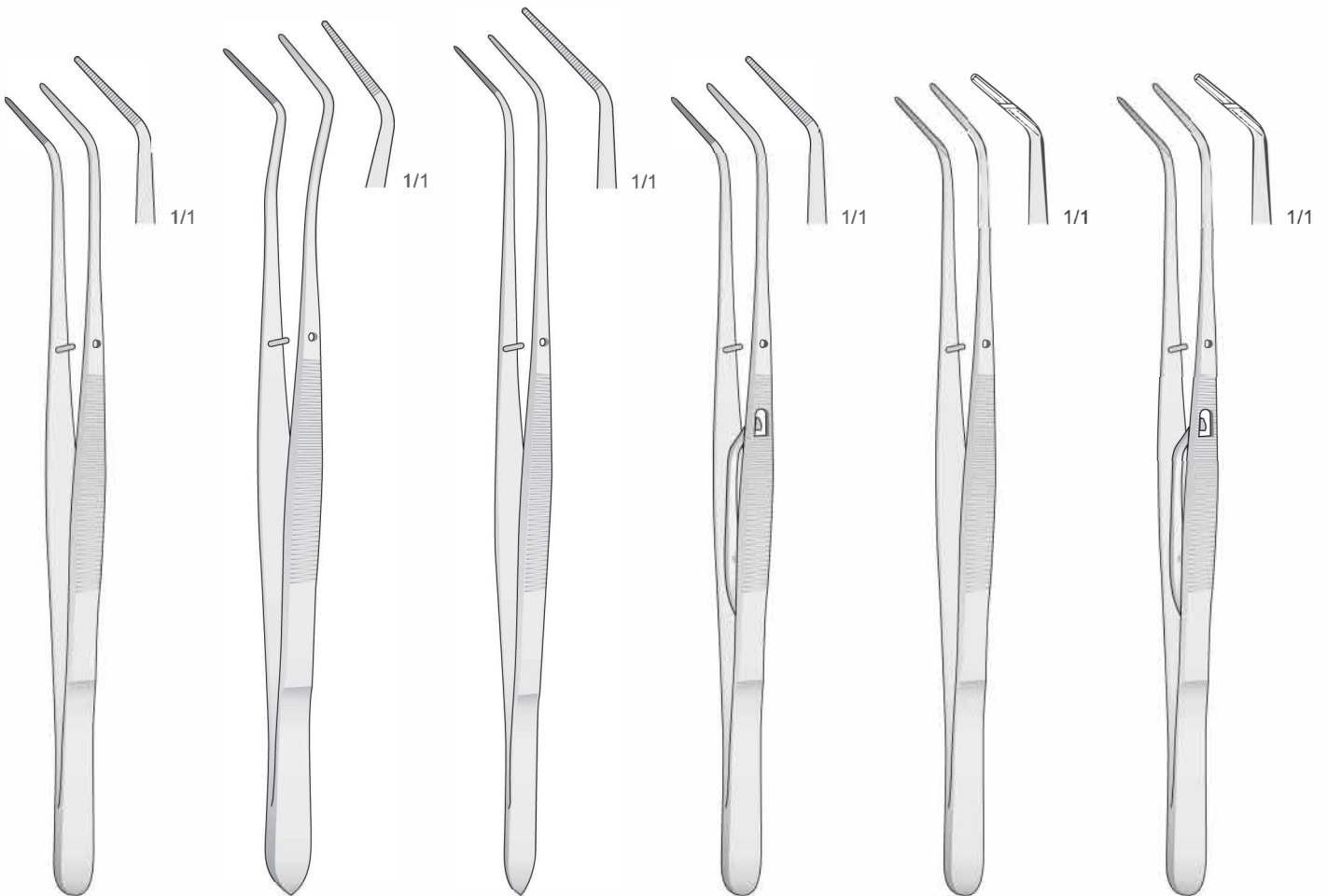

**SI-10641**  
150 mm

**SI-10642**  
160 mm

**SI-10643**  
160 mm

**SI-10644**  
150 mm

**SI-10645**  
150 mm

**SI-10646**  
150 mm



Zahnpinzetten  
Cotton and Dressing Pliers  
Pinzette per medicazione  
Pinzas para vendajes  
Précèlles pour cotton

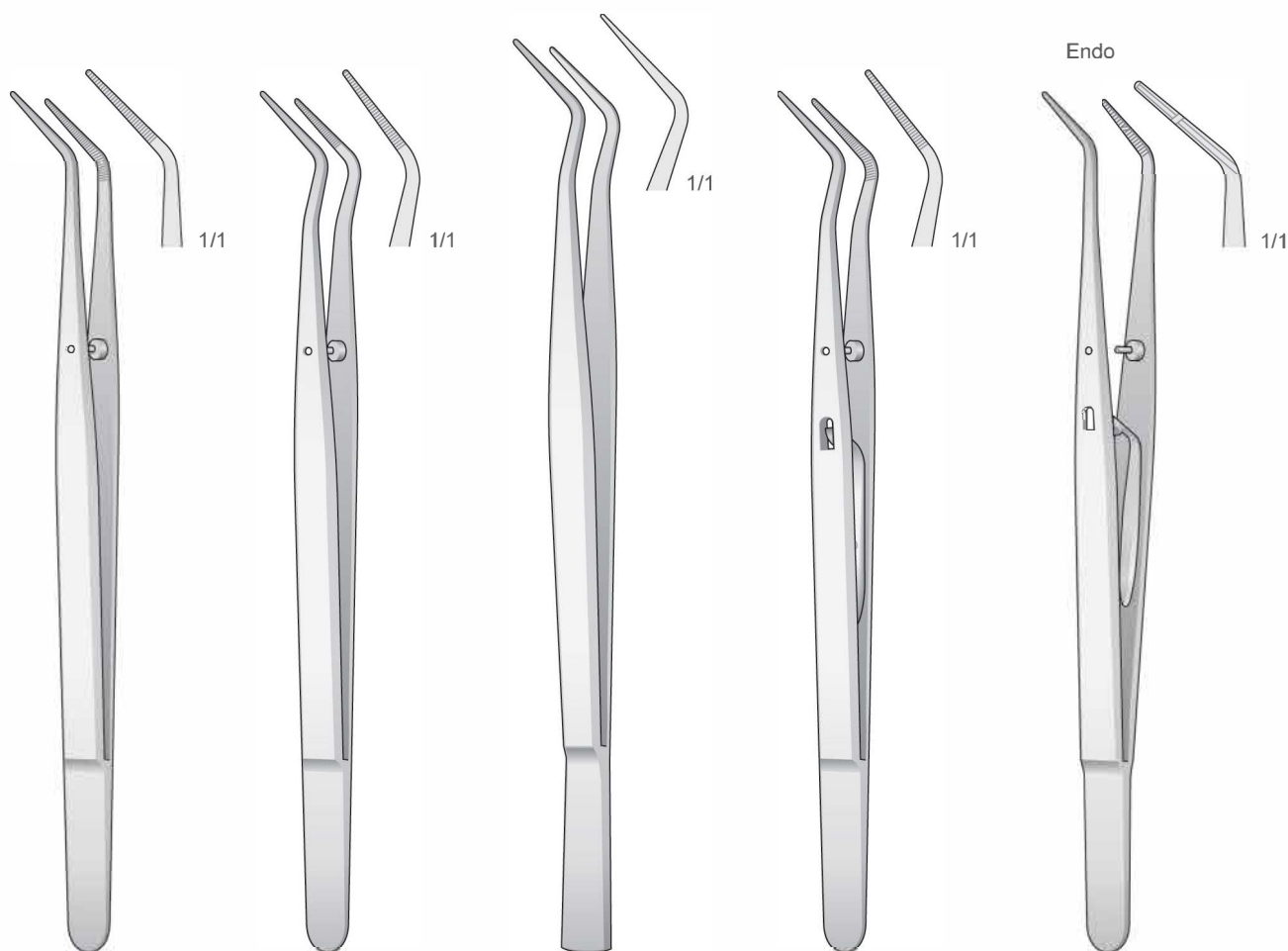

**COLLEGE**  
SI-10647  
150 mm

**MERIAM**  
SI-10648  
150 mm

**CAULK**  
SI-10649  
160 mm

**LOCKING**  
SI-10650  
150 mm

**SI-10651**  
150 mm



Chirurgische und Anatomische Pinzetten  
 Tissue and Dressing Forceps  
 Pinzette anatomiche e chirurgiche  
 Pinzas de diseccion y chirùrgicas  
 Pinces anatomiques chirurgicales



DE BAKEY  
**SI-10659**

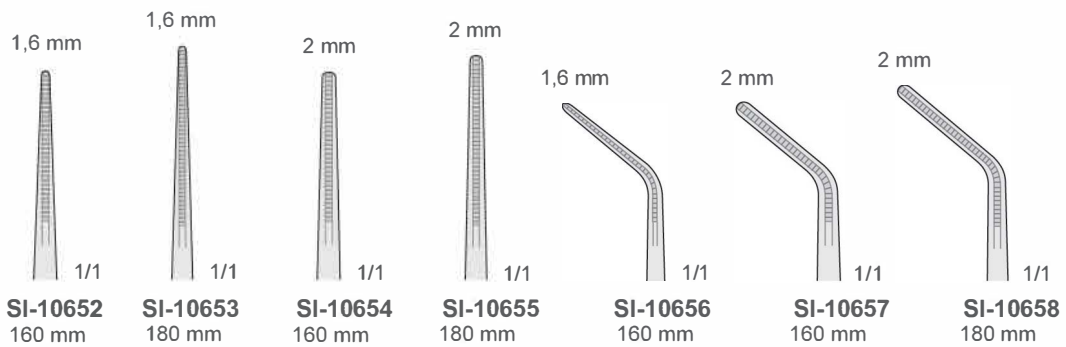

Atraumatische pinzetten  
 Non-traumatic forceps  
 Pinzette atraumatiche  
 Pinzas atraumaticas  
 Pinces atraumatiques

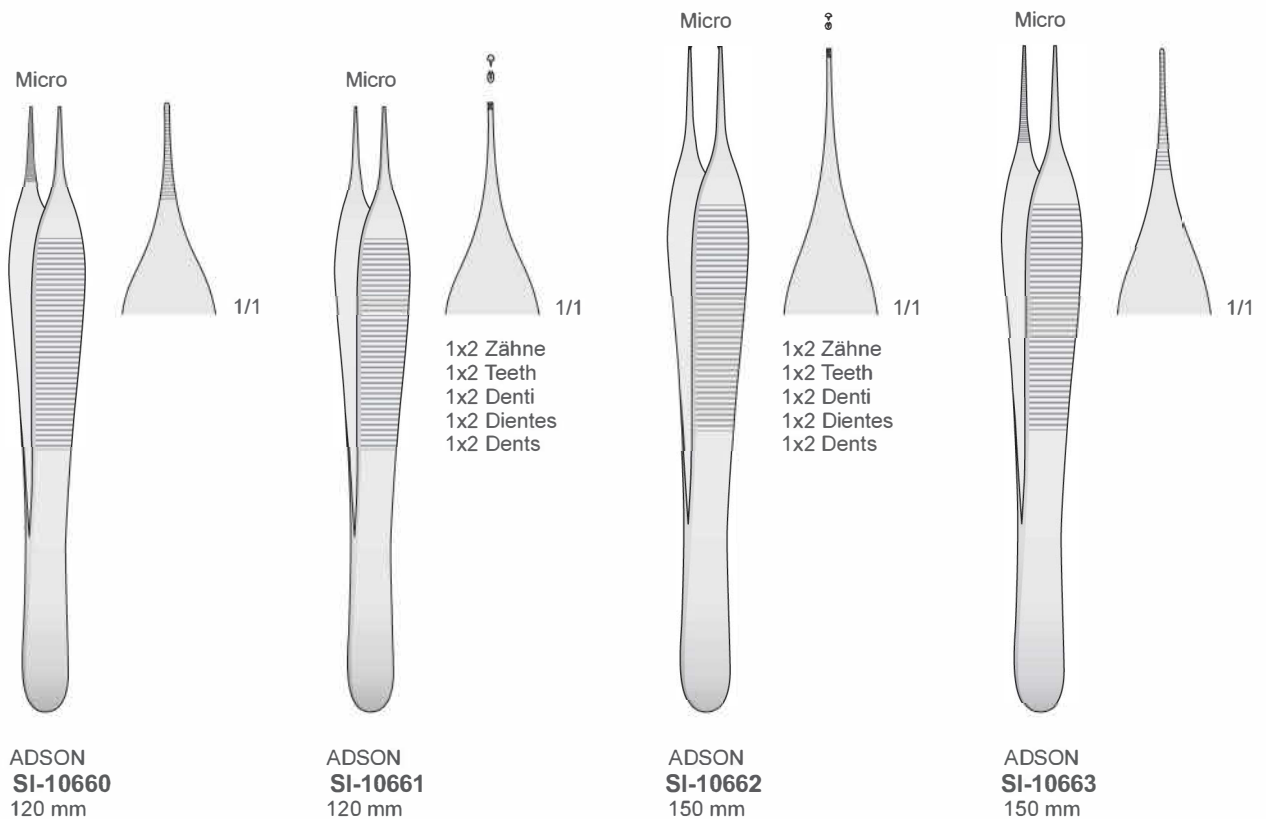





Chirurgische Pinzetten  
Tissue Forceps  
Pinzette chirurgiche  
Pinzas quirùrgicas  
Pincas quirurgicales

Taschenmarkierungspinzetten  
Pocket markers  
Pinzette segnatasche  
Pinzas para marcar el sulco periodontal  
Pincas à marquer la poche

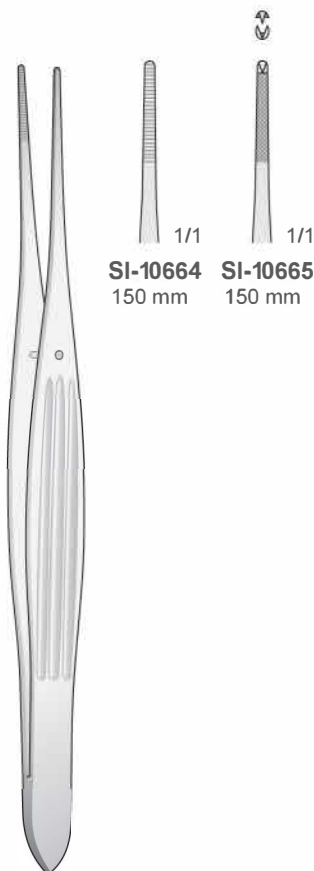

McINDOE  
**SI-10668**  
150 mm

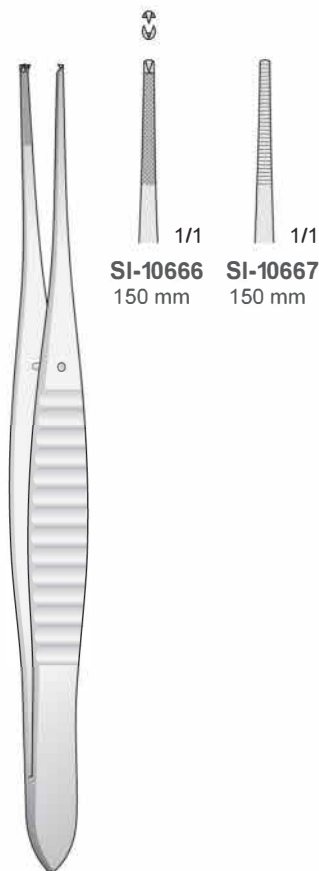

GILLIES  
**SI-10669**  
150 mm

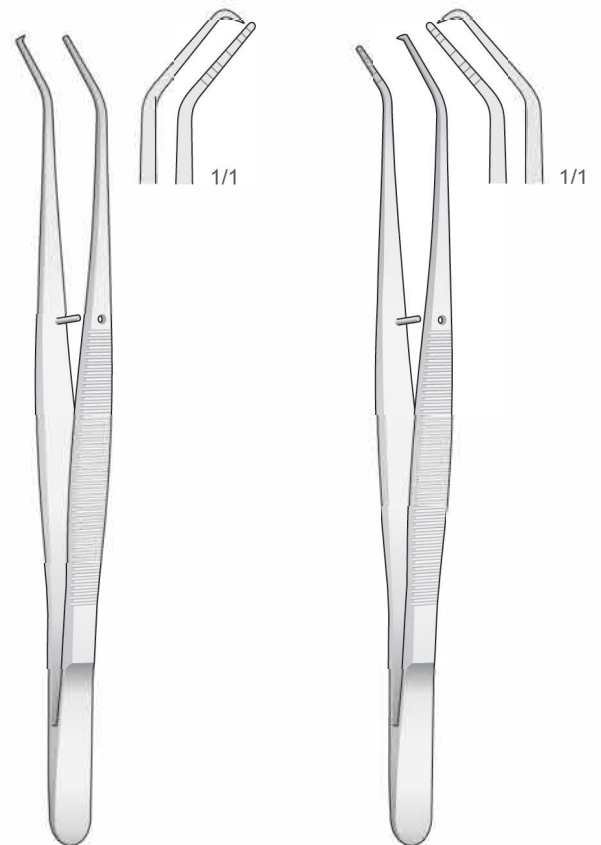

CRANE-CAPLAN  
**SI-10670**  
150 mm

CRANE-CAPLAN  
**SI-10671**  
150 mm



Chirurgische Pinzetten  
Tissue Forceps  
Pinzette chirurgiche  
Pinzas quirúrgicas  
Pincas quirurgicales



GRAEFE  
**SI-1067B**  
100 mm



GRAEFE  
**SI-10679**  
100 mm

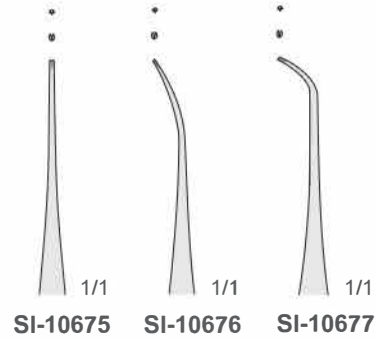

**SI-106B0**  
100 mm

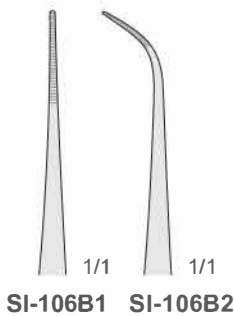

**SI-106B3**  
100 mm

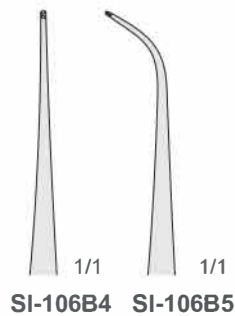

PERRY  
**SI-106B6**  
125 mm

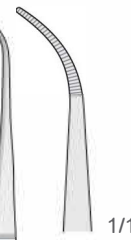

**SI-106B7**  
125 mm

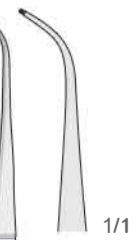



Anatomische Pinzetten  
Dressing Forceps  
Pinzette anatomiche  
Pinzas de diseccion  
Pincas anatomiques

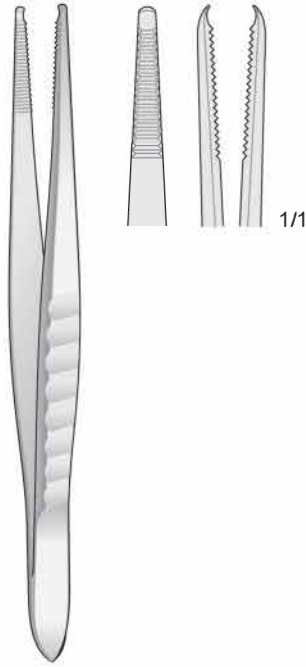

**SI-10688**  
130 mm



**SI-10689**  
130 mm

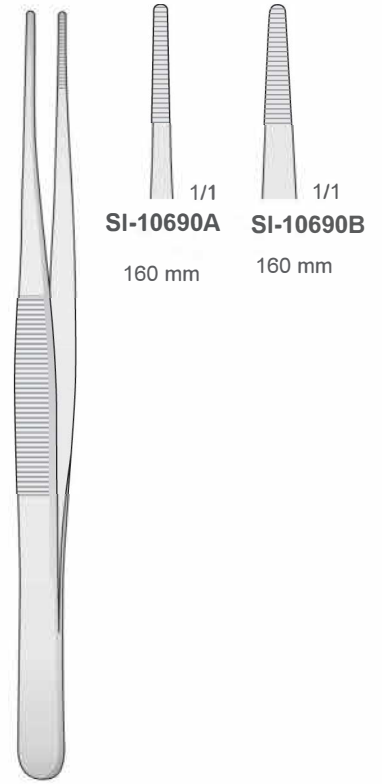

**SI-10690**  
160 mm

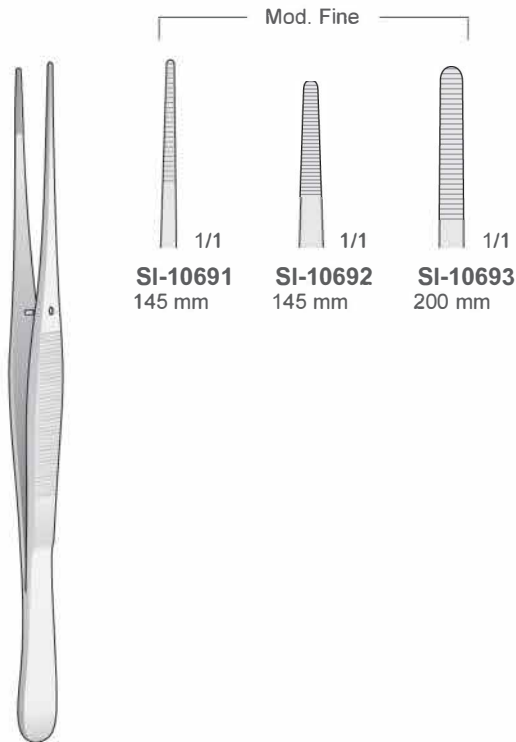

**SI-10697**

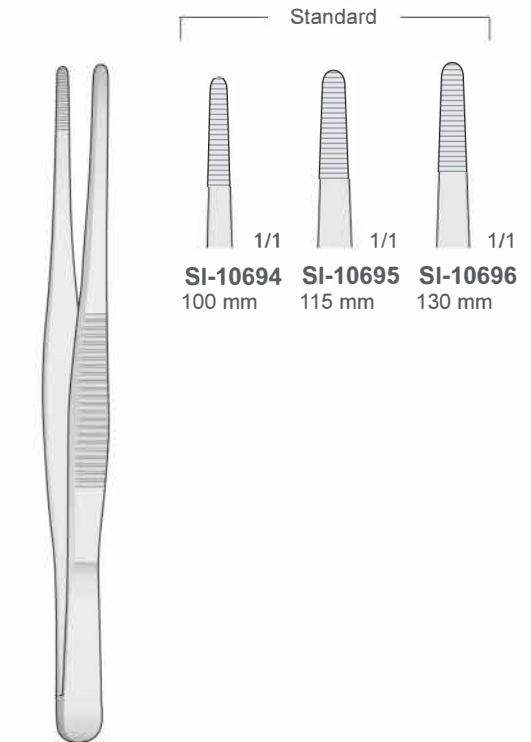

**SI-10698**



Chirurgische Pinzetten  
Tissue Forceps  
Pinzette chirurgiche  
Pinzas quirúrgicas  
Pincas quirurgicales

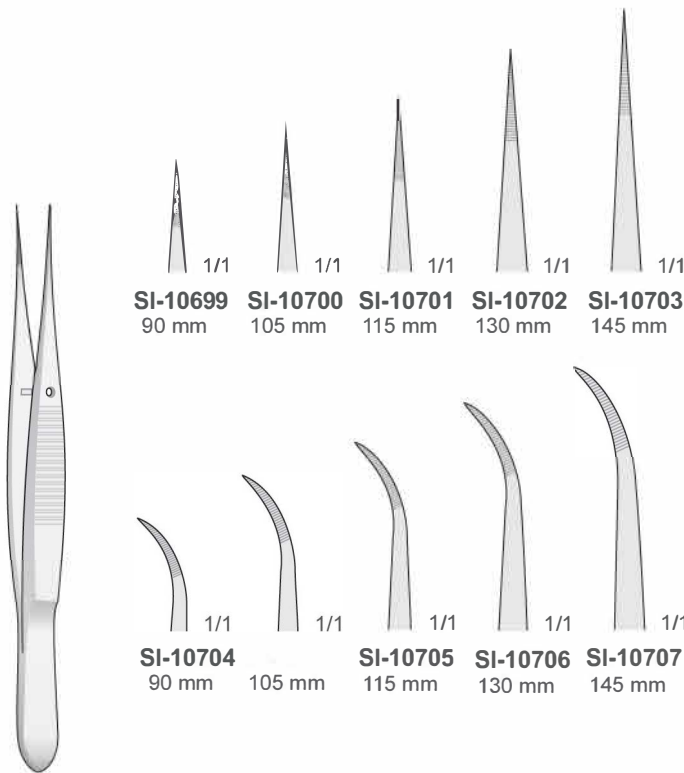

SI-10710

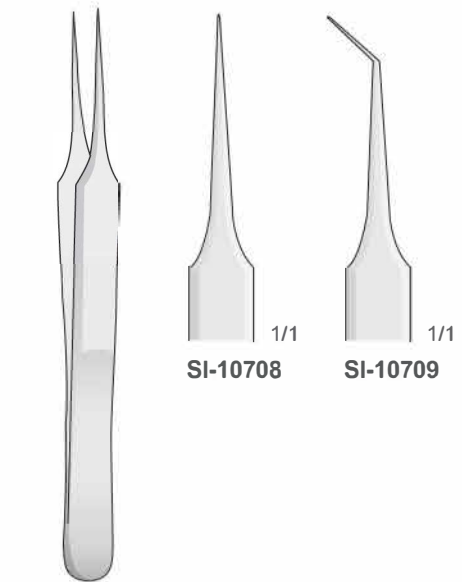

SI-10711  
110 mm

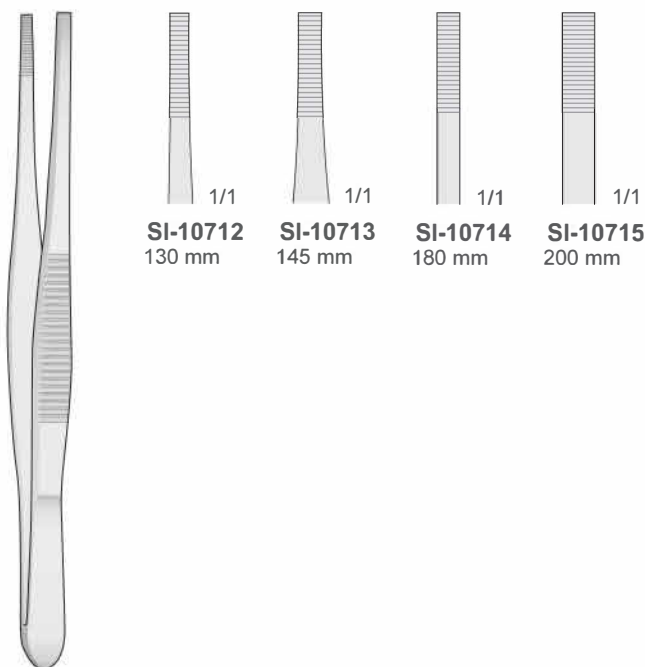

STILLE  
SI-10716

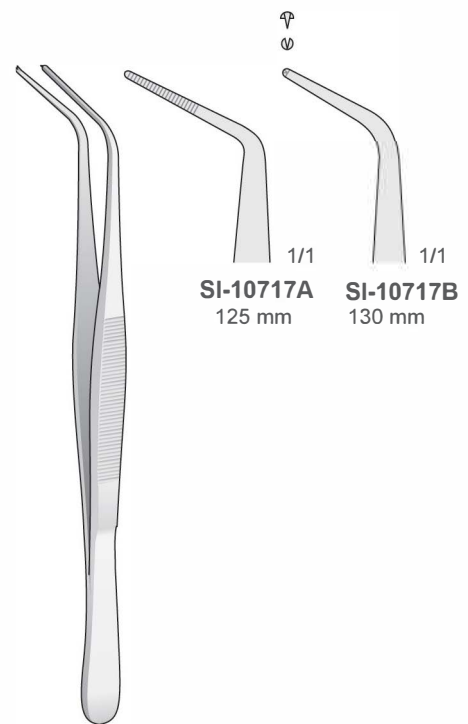

SI-10717



Chirurgische Pinzetten  
Tissue Forceps  
Pinzette chirurgiche  
Pinzas quirúrgicas  
Pincas quirúrgicas



**SI-10719**

**SI-1071B**  
110 mm

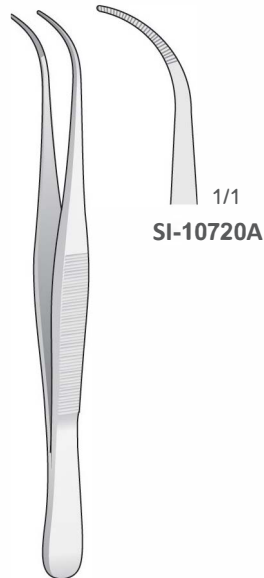

**SI-10720A**

**SI-10720**  
110 mm

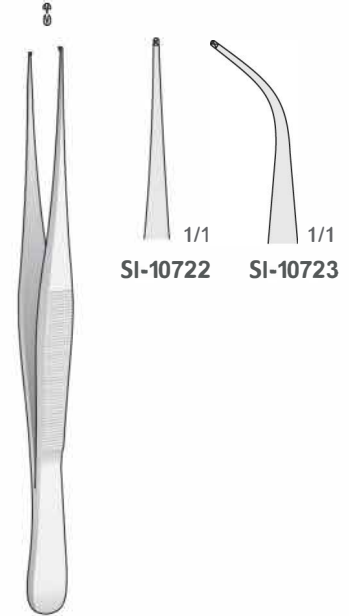

**SI-10722** **SI-10723**

**SI-10721**  
110 mm

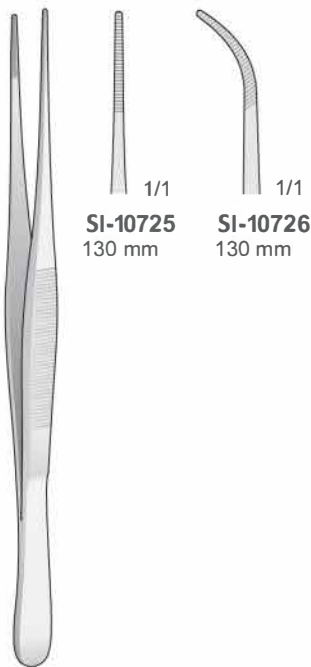

**SEMKEN**  
**SI-10724**  
130 mm

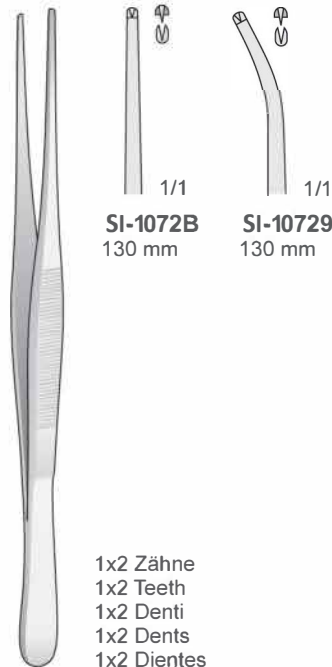

**SEMKEN**  
**SI-10727**  
130 mm

1x2 Zähne  
1x2 Teeth  
1x2 Denti  
1x2 Dents  
1x2 Dientes

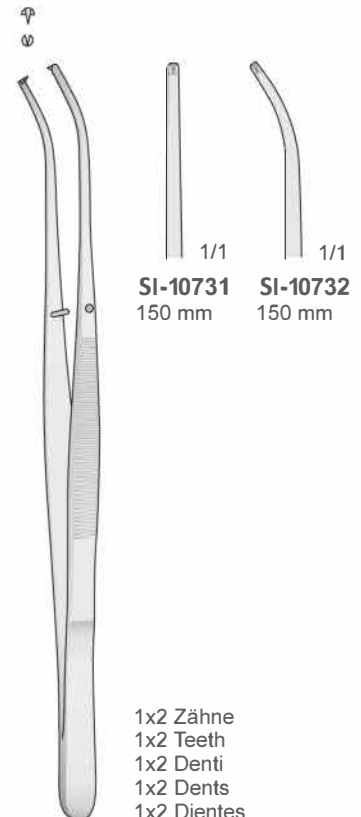

**SEMKEN**  
**SI-10730**  
150 mm

1x2 Zähne  
1x2 Teeth  
1x2 Denti  
1x2 Dents  
1x2 Dientes



Chirurgische Pinzetten  
Tissue Forceps  
Pinzette chirurgiche  
Pinzas quirúrgicas  
Pincas quirúrgicas

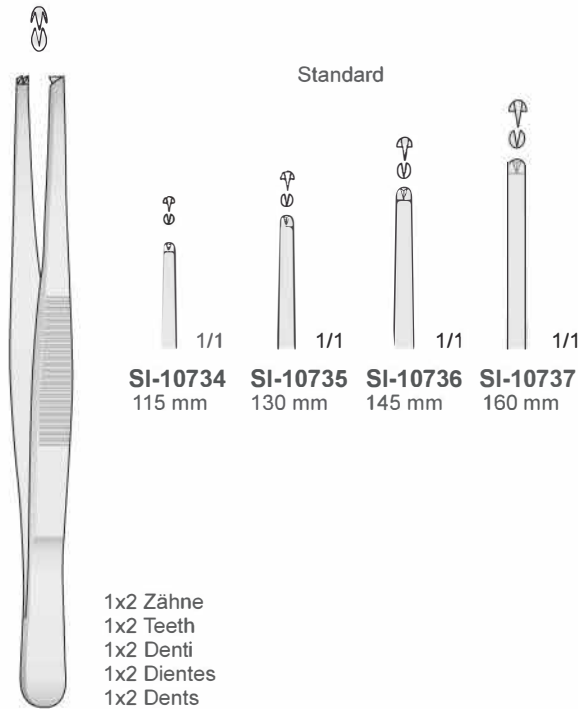

SI-10733

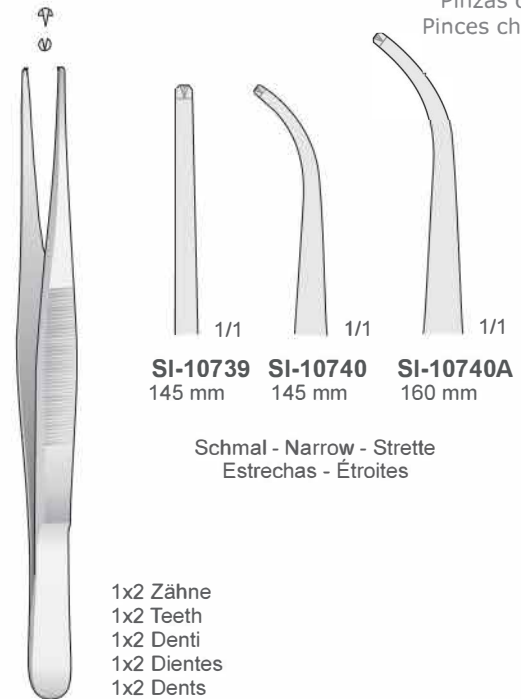

SI-10738

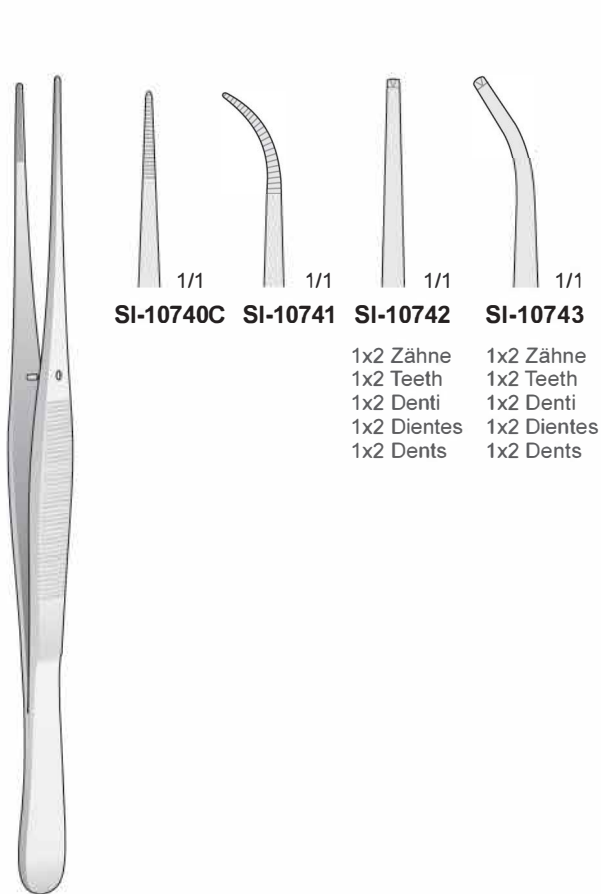

SI-10740B  
200 mm

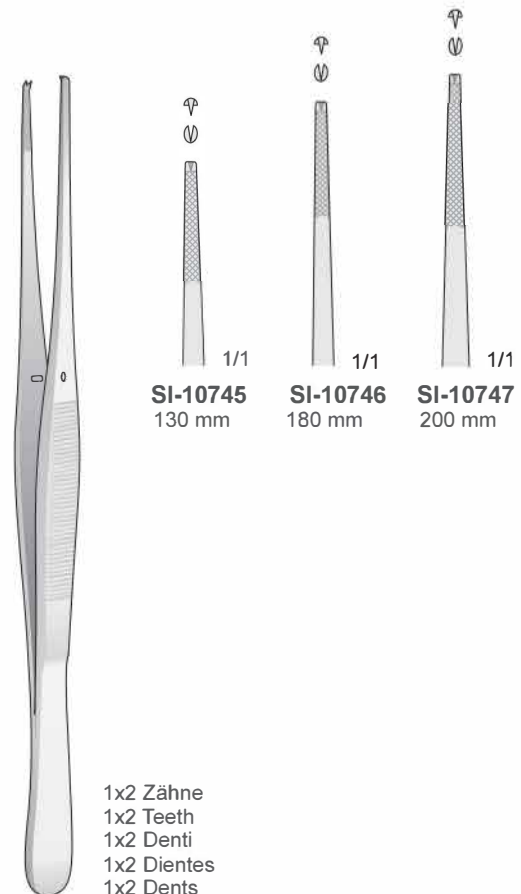

SI-10744





Chirurgische Pinzetten  
Tissue Forceps  
Pinzette chirurgiche  
Pinzas quirùrgicas  
Pinces chirurgicales

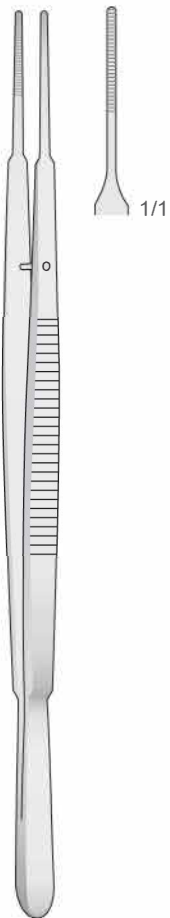

**GERALD  
SI-10749**  
180 mm

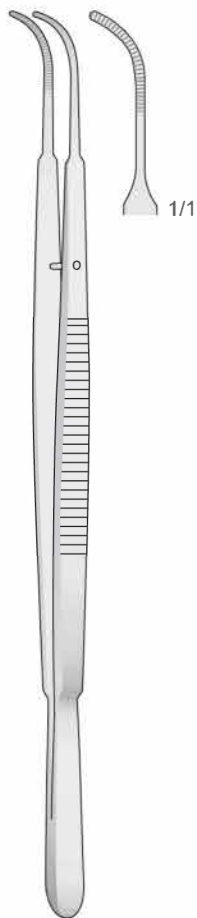

**GERALD  
SI-10750**  
180 mm



**GERALD  
SI-10751**  
180 mm

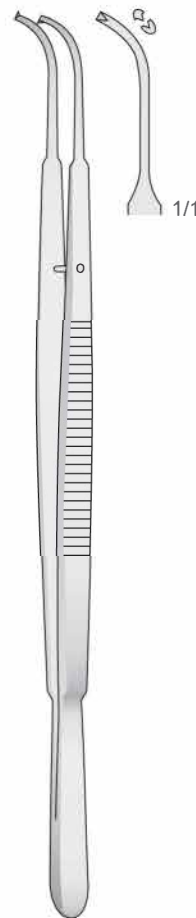

**GERALD  
SI-10752**  
180 mm

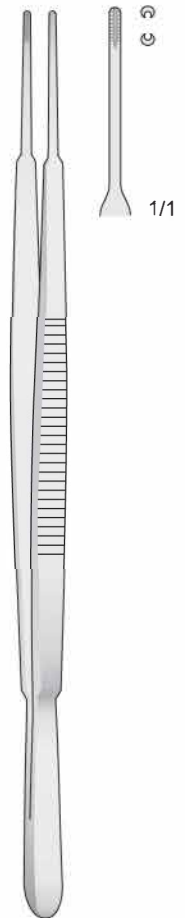

**GERALD-BROWN  
SI-10753**  
180 mm

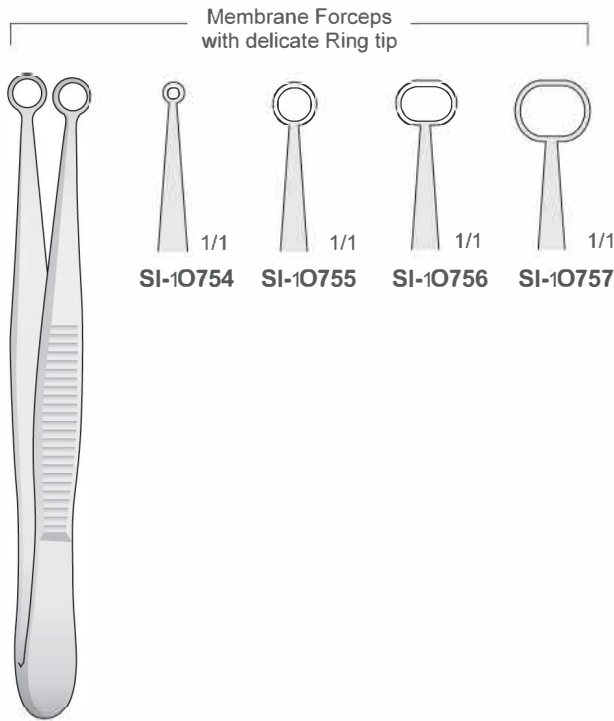

Chirurgische Pinzetten  
Tissue Forceps  
Pinzette chirurgiche  
Pinzas quirúrgicas  
Pincas quirúrgicas

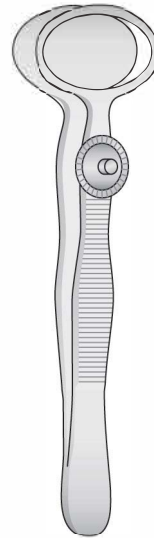

DESMARRES  
SI-10761  
90 mm

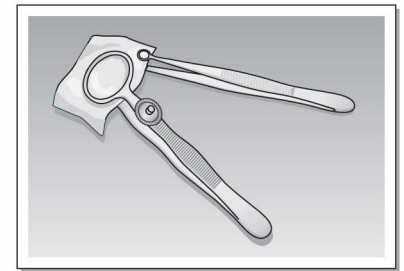
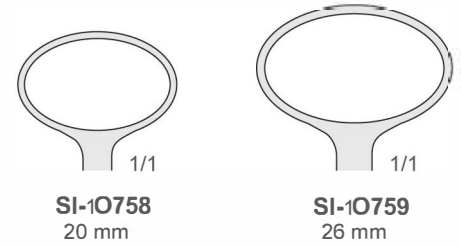

SI-10760  
100 mm

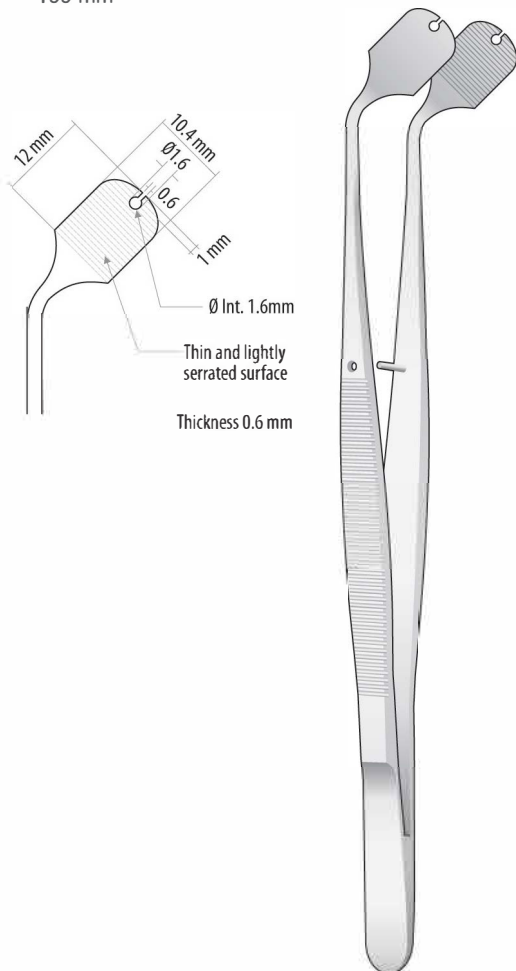

SI-10762  
150 mm

Pinzetten zum Halten Membranen  
Membrane Holding forceps  
Pinza per fissaggio membrane  
Pinza para sostener membranas  
Pince pour le maintien membranes

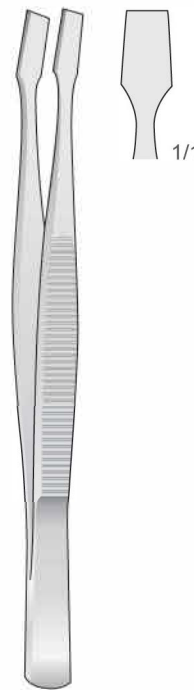

KÜHNE  
SI-10763  
105 mm

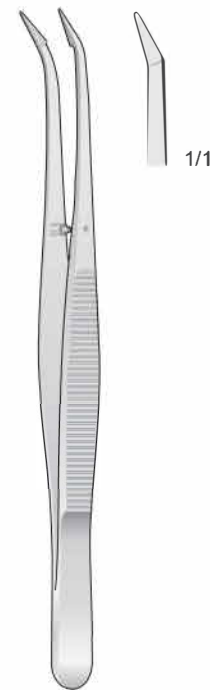

BARRAQUER  
SI-10764  
105 mm



Chirurgische Pinzetten  
Tissue Forceps  
Pinzette chirurgiche  
Pinzas quirúrgicas  
Pincas quirúrgicas

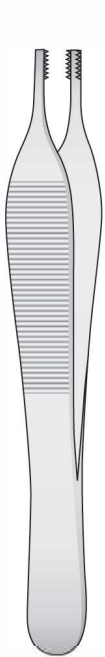

**ADSON-BROWN**  
**SI-10769**  
120 mm

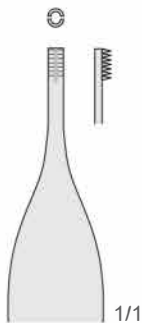

**SI-10765**  
120 mm

6x6 Zähne  
6x6 Teeth  
6x6 Denti  
6x6 Dientes  
6x6 Dents

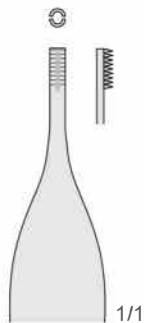

**SI-10766**  
120 mm

9x9 Zähne  
9x9 Teeth  
9x9 Denti  
9x9 Dientes  
9x9 Dents

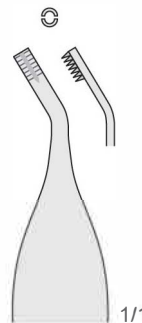

**SI-10767**  
120 mm

6x6 Zähne  
6x6 Teeth  
6x6 Denti  
6x6 Dientes  
6x6 Dents



**ADSON**  
**SI-10770**  
120 mm

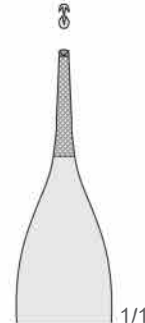

**SI-10768**  
120 mm



**BROWN**  
**SI-10771**  
150 mm

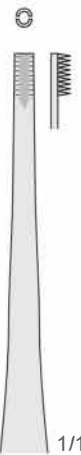

8x8 Zähne  
8x8 Teeth  
8x8 Denti  
8x8 Dientes  
8x8 Dents



**ADSON**  
**SI-10772**  
150 mm

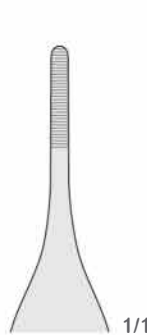

**ADSON**  
**SI-10773**  
150 mm



1x2 Zähne  
1x2 Teeth  
1x2 Denti  
1x2 Dientes  
1x2 Dents



**ADSON-BROWN**  
**SI-10774**  
150 mm

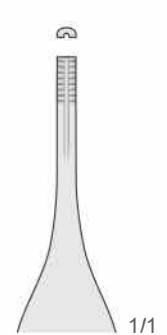

9x9 Zähne  
9x9 Teeth  
9x9 Denti  
9x9 Dientes  
9x9 Dents



Chirurgische Pinzetten  
Tissue Forceps  
Pinzette chirurgiche  
Pinzas quirúrgicas  
Pincas chirurgicales

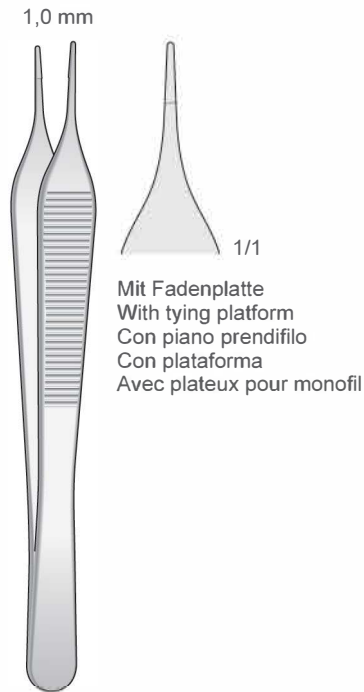

ADSON  
**SI-10775**  
120 mm

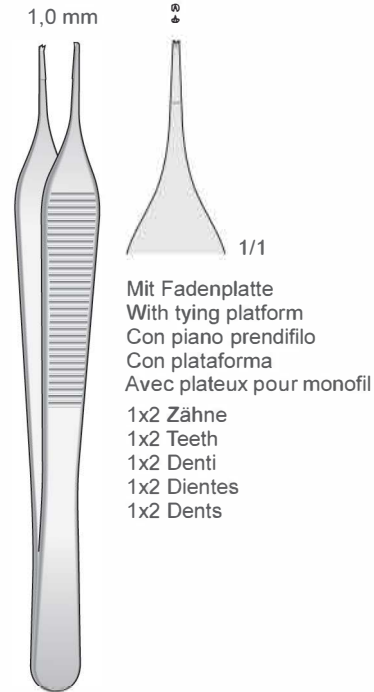

ADSON  
**SI-10776**  
120 mm

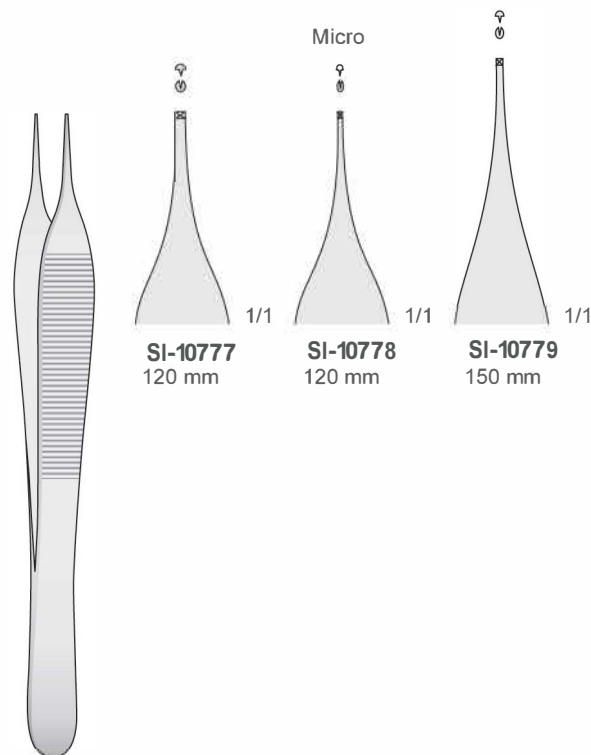

ADSON  
**SI-10783**

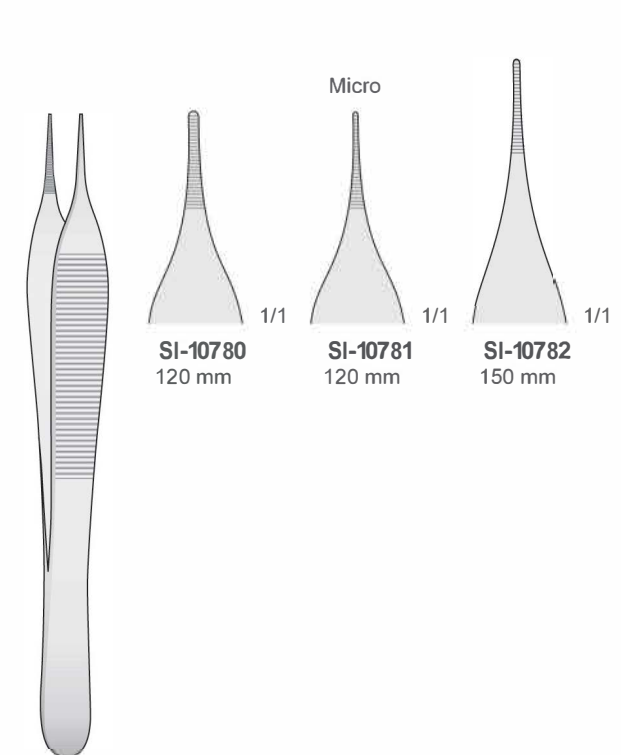

ADSON  
**SI-10784**



Chirurgische Pinzetten - Anatomische Pinzetten

Tissue Forceps - Dressing forceps  
Pinzette chirurgiche - Pinzette anatomiche  
Pinzas quirùrgicas - Pinzas de diseccion  
Pincas quirurgicales - Pincas anatomicas



**SI-10791**

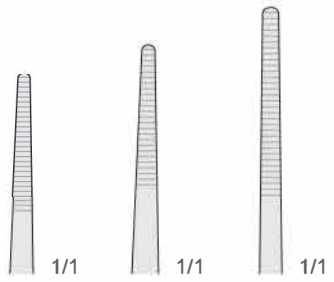

**SI-10785** 130 mm  
**SI-10786** 180 mm  
**SI-10787** 200 mm



**SI-10792**

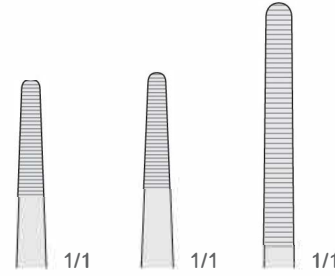

**SI-10788** 230 mm  
**SI-10789** 250 mm  
**SI-10790** 300 mm



**SI-10798**

1x2 Zähne  
1x2 Teeth  
1x2 Denti  
1x2 Dientes  
1x2 Dents

Schmal - Narrow  
Strette - Estrechas  
Étroites

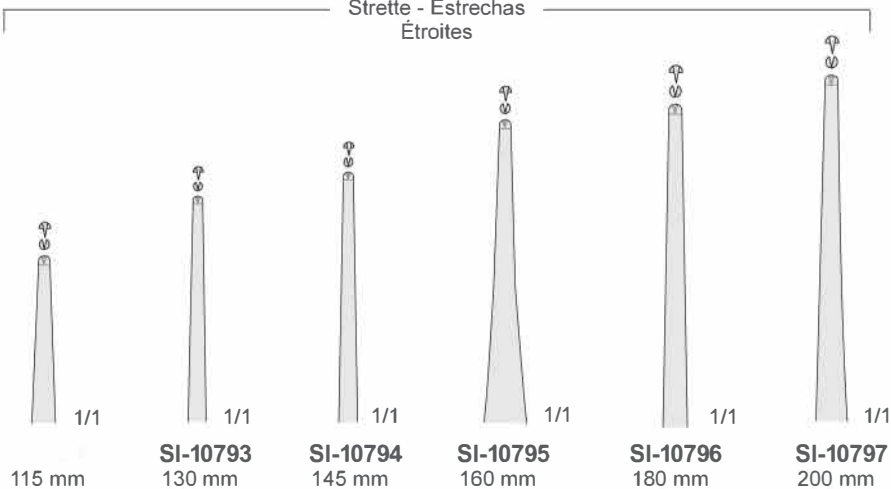

115 mm  
**SI-10793** 130 mm  
**SI-10794** 145 mm  
**SI-10795** 160 mm  
**SI-10796** 180 mm  
**SI-10797** 200 mm



Chirurgische Pinzetten  
Tissue Forceps  
Pinzette chirurgiche  
Pinzas quirúrgicas  
Pincas chirurgicales

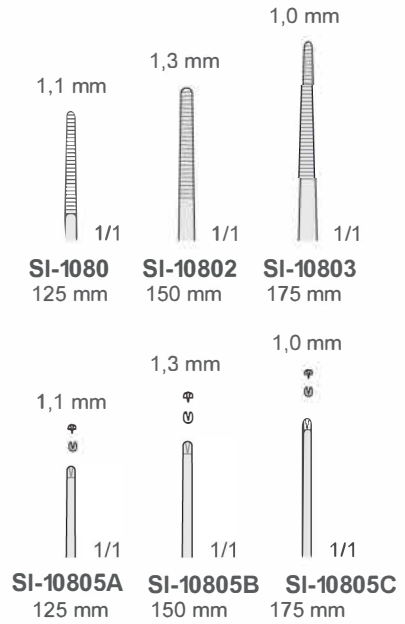
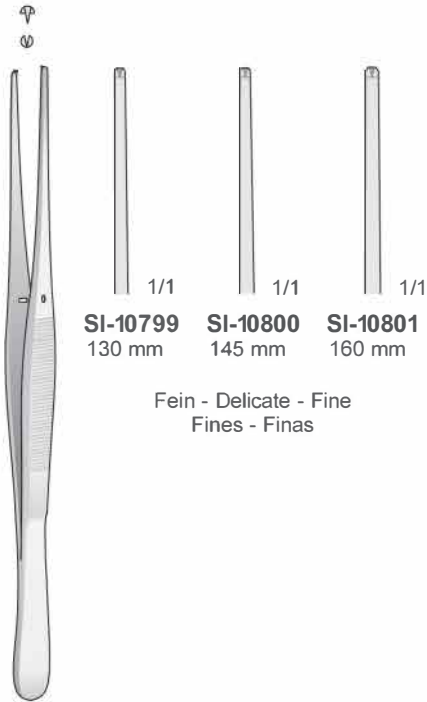

SI-10804

SI-10805

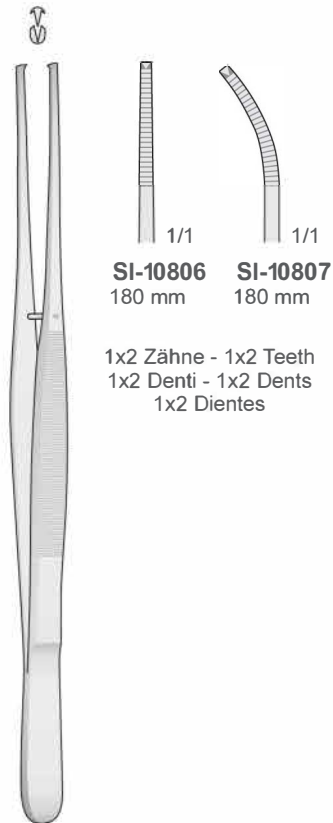

POTTS-SMITH  
SI-10811  
180 mm

POTTS-SMITH  
SI-10812





Nadelhalter  
Needle Holders  
Port'aghi  
Portaagujas  
Porte aiguilles

Mit Scheren  
With Scissor  
Con forbice  
Con tijeras  
Avec ciseaux

Glattes Maul  
Smooth Jaw  
Morso liscio  
Mandibula lisa  
Mors lisse

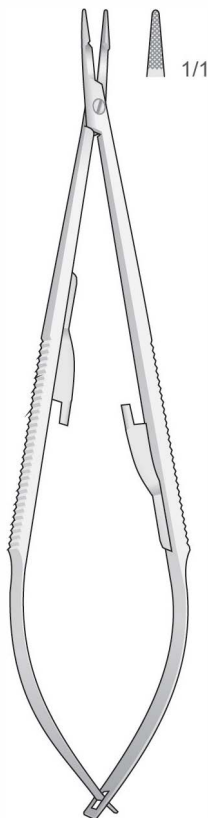

**SI-10817**  
140 mm



**SI-10818**  
140 mm



**SI-10813**  
140 mm



**SI-10814**  
140 mm

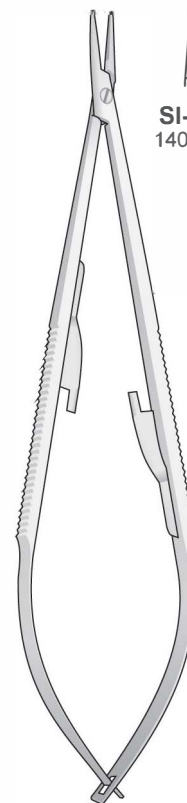

**CASTROVIEJO**  
**SI-10819**  
140 mm



**SI-10815**  
140 mm



**SI-10816**  
140 mm



Nadelhalter  
Needle Holders  
Port'aghi  
Portaaguja  
Porte aiguilles

Mit Locking-System  
With Locking System (stop)  
Con sistema di bloccaggio  
Con sistema de bloqueo  
Avec système de verrouillage

Glattes Maul  
Smooth Jaw  
Morso liscio  
Mandibula lisa  
Mors lisse

Feingeriefes Maul  
Fine serrated jaws  
Morso zigrinato fine  
Mandibula estriada fina  
Mors strié fin

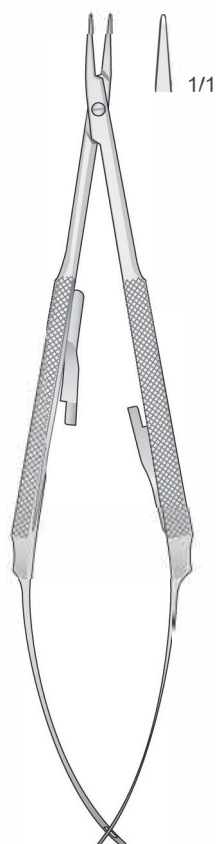

**BARRAQUER**  
**SI-10820**  
150 mm

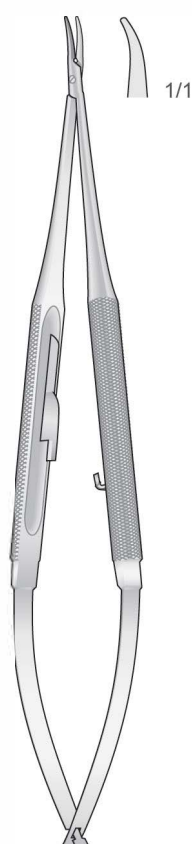

**BARRAQUER**  
**SI-10821**  
150 mm



**BARRAQUER**  
**SI-10822**  
150 mm

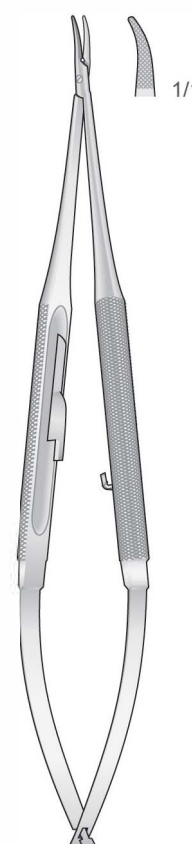

**BARRAQUER**  
**SI-10823**  
150 mm



Nadelhalter  
Needle Holders  
Port'aghi  
Portaagujas  
Porte aiguilles

**TC**  
TUNGSTEN  
CARBIDE

**Tungsten-Carbide Inserts**  
Mit Hartmetalleinsätzen  
Plaquettes en carbure de tungstène  
Plaquetas de carburo de tungsteno  
Inserti in carburo di tungsteno

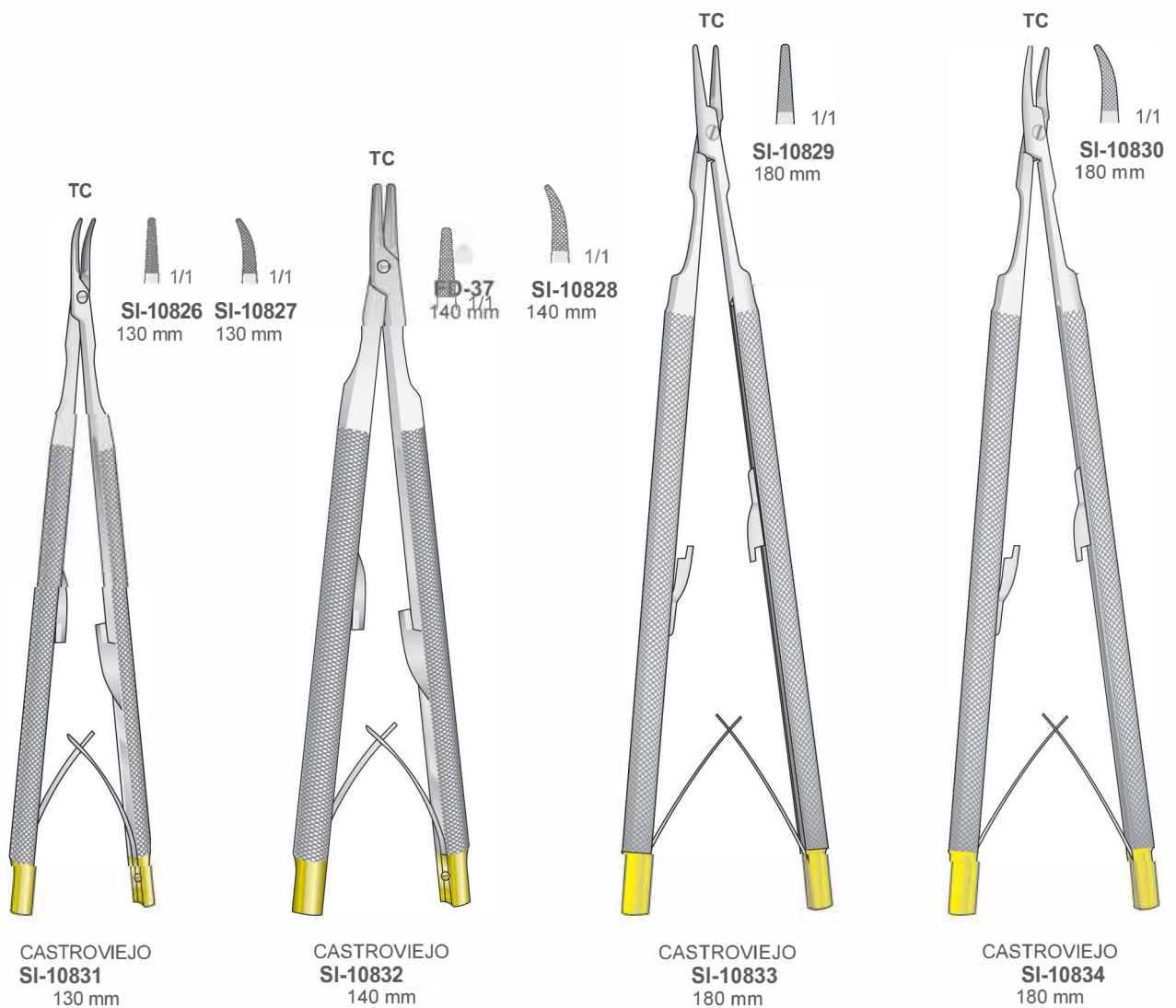



Nadelhalter  
Needle Holders  
Port'aghi  
Portaagujas  
Porte aiguilles



**Tungsten-Carbide Inserts**  
Mit Hartmetalleinsätzen  
Plaquettes en carbure de tungstène  
Plaquetas de carburo de tungsteno  
Inserti in carburo di tungsteno

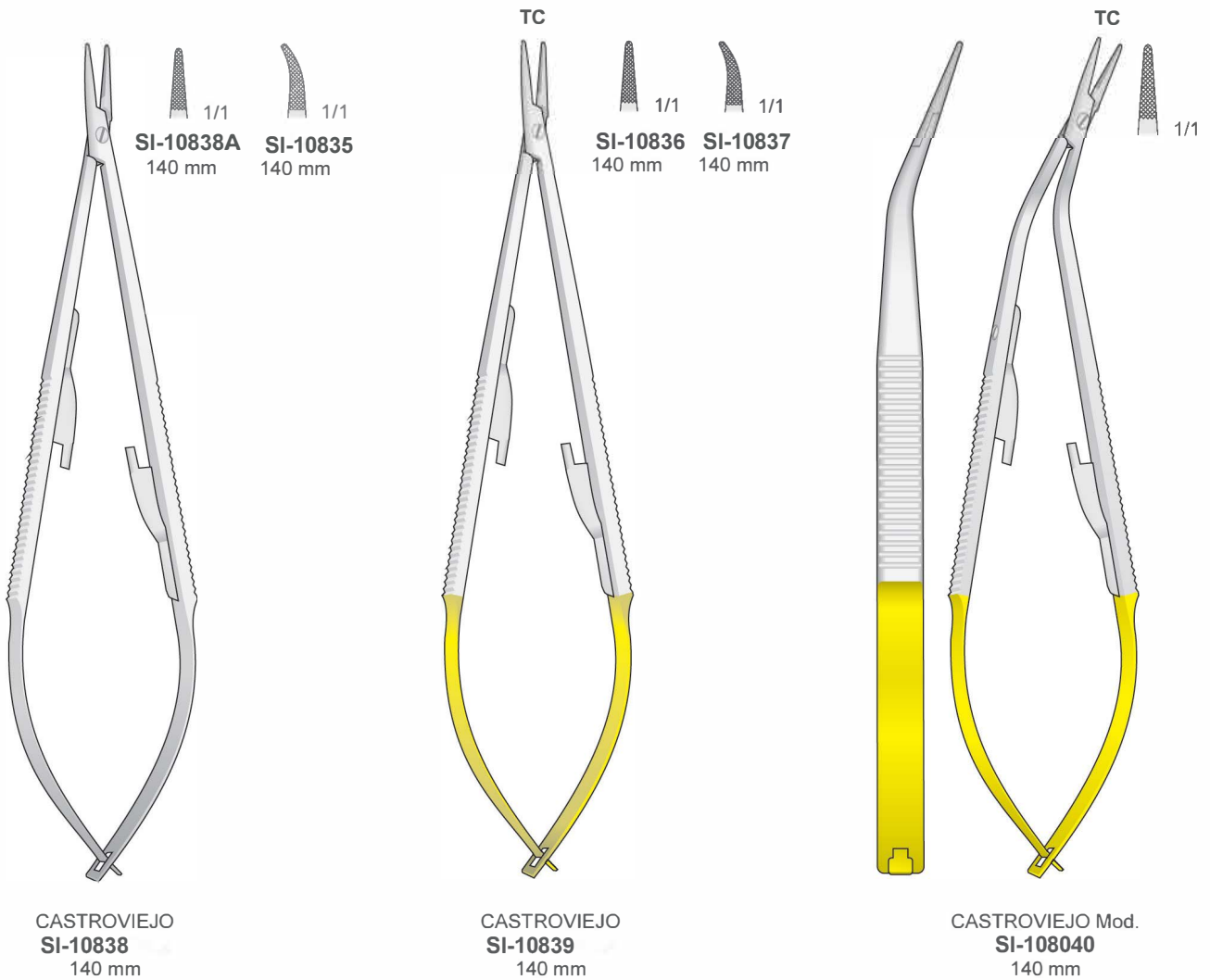



Nadelhalter  
Needle Holders  
Port'aghi  
Portaagujas  
Porte aiguilles



**Tungsten-Carbide Inserts**  
Mit Hartmetalleinsätzen  
Plaquettes en carbure de tungstène  
Plaquetas de carburo de tungsteno  
Inserti in carburo di tungsteno

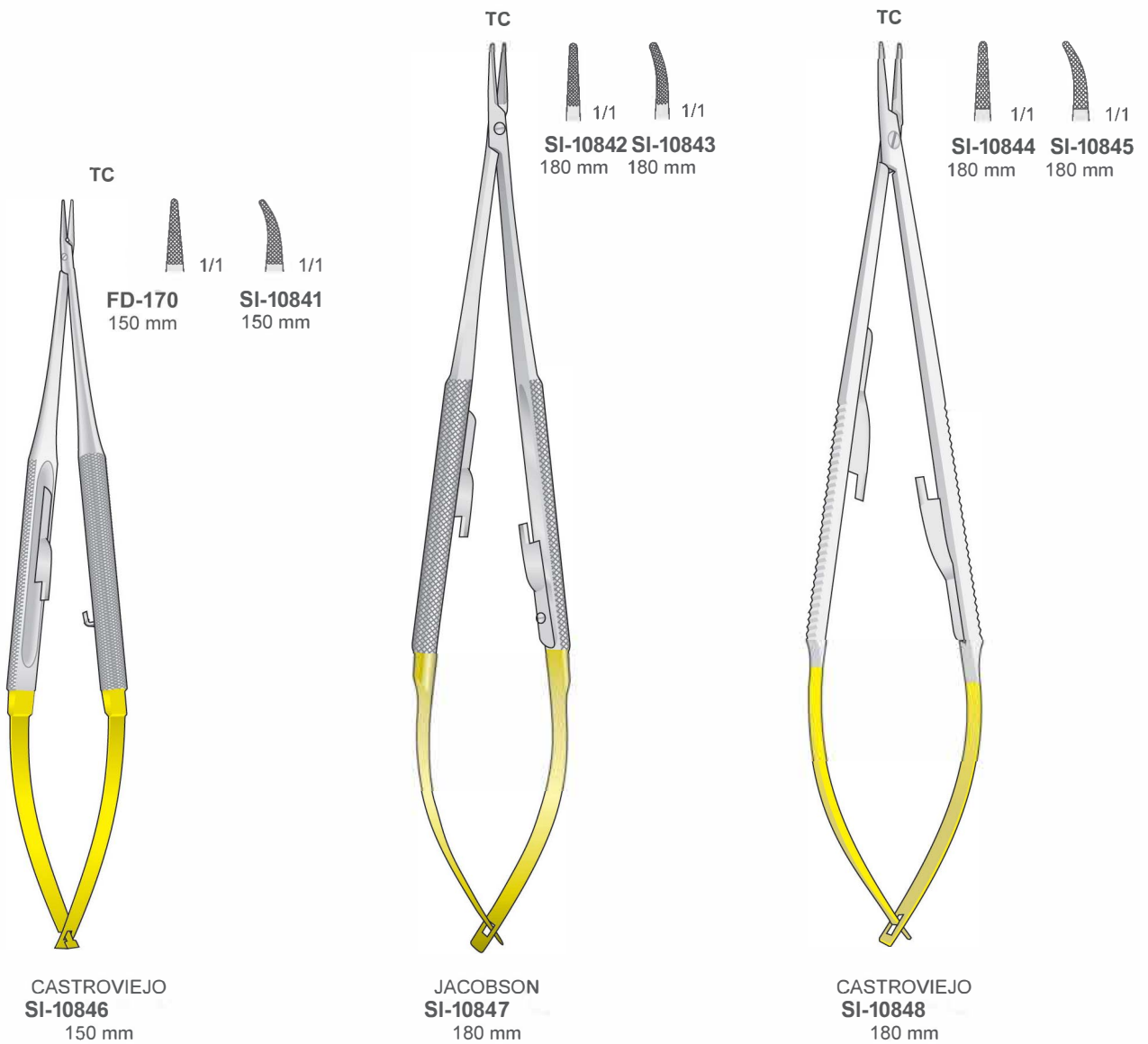



Nadelhalter  
Needle Holders  
Port'aghi  
Portaagujas  
Porte aiguilles

**TC**  
TUNGSTEN  
CARBIDE

**Tungsten-Carbide Inserts**  
Mit Hartmetalleinsätzen  
Plaquettes en carbure de tungstène  
Plaquetas de carburo de tungsteno  
Inserti in carburo di tungsteno

Glattes Maul  
Smooth jaws  
Con morso liscio  
Mandibula lisa  
A' mors lisse

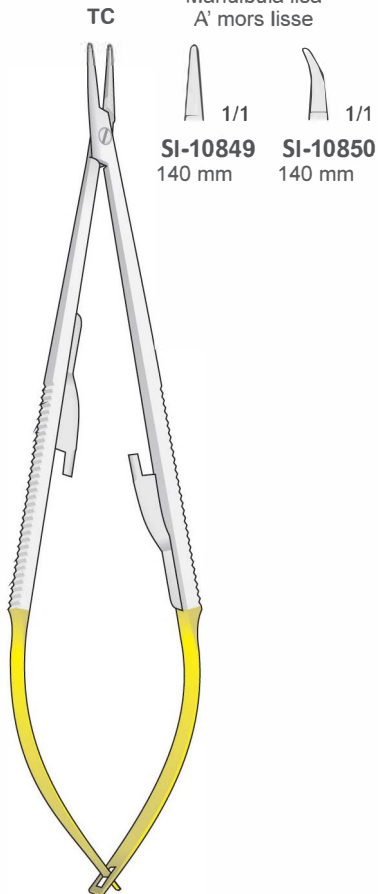

CASTROVIEJO  
**SI-10853**  
140 mm

**DIAMOND TIP**

**Diamond Tip**  
Diamantiert  
Punta diamantata  
Punta de diamante  
Pointe de diamant

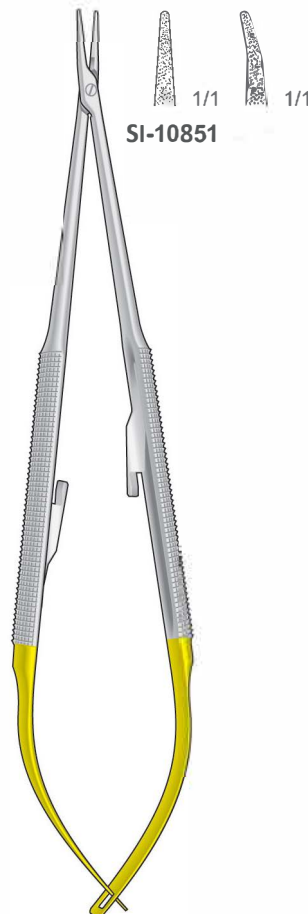

**SI-10854**  
150 mm

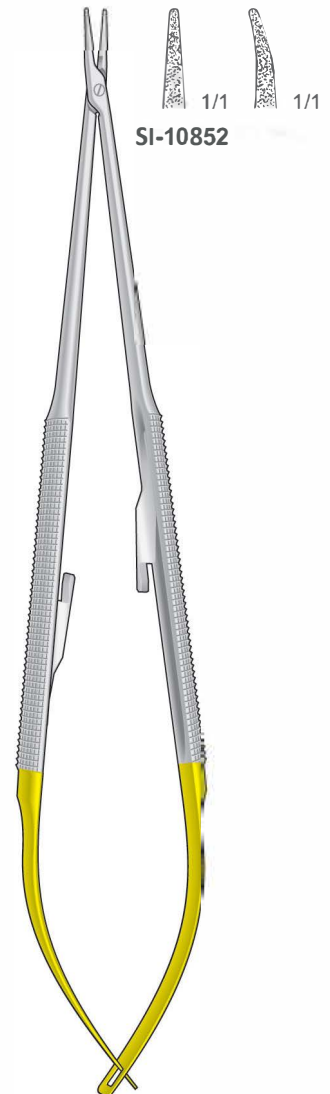

**SI-10855**  
180 mm





Mikro Nadelhalter - Mikro Scheren  
 Micro Needle Holders - Micro Scissors  
 Micro Port'aghi - Micro Forbici  
 Micro Portaagujas - Micro Tijeras  
 Micro Porte aiguilles - Micro Ciseaux



**Titanium**  
 Titan  
 Titane  
 Titanio  
 Titanio

Rund-Griffe Ø 8 mm  
 Round handle Ø 8 mm  
 Manico rotondo Ø 8 mm  
 Mango redondo Ø 8 mm  
 Manche rond Ø 8 mm

Mikro Nadelhalter  
 Micro Needle Holders  
 Micro port'aghi  
 Micro portaagujas  
 Micro porte aiguilles

Mikro Scheren  
 Micro Scissors  
 Micro forbici  
 Micro tijeras  
 Micro ciseaux

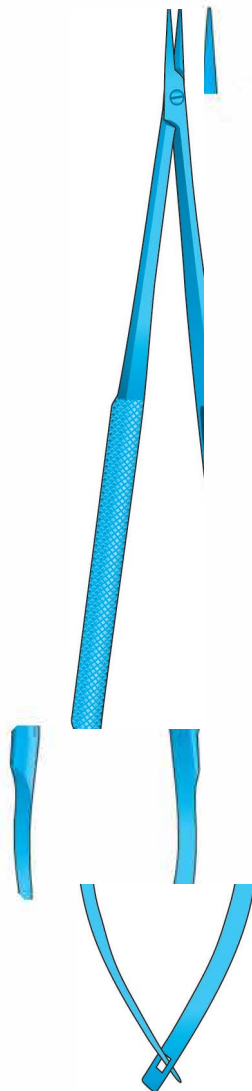

1/1 1/1  
**SI-10856**  
**SI-10857**

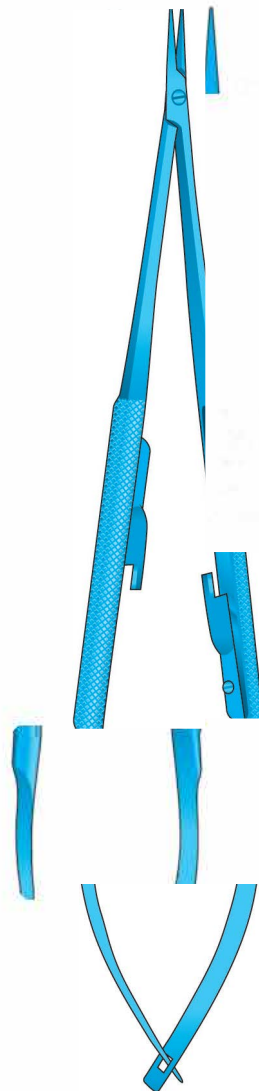

1/1 1/1  
**SI-10858**  
**SI-10859**

Mit Sperre  
 With Lock  
 Con arresto  
 Con cierre  
 Avec Arrêt



1/1 1/1  
**SI-10860** **SI-10861**

**SI-10862**  
 180 mm

**SI-10863**  
 180 mm

**SI-10864**  
 180 mm



Nadelhalter  
Needle Holders  
Port'aghi  
Portaagujas  
Porte aiguilles

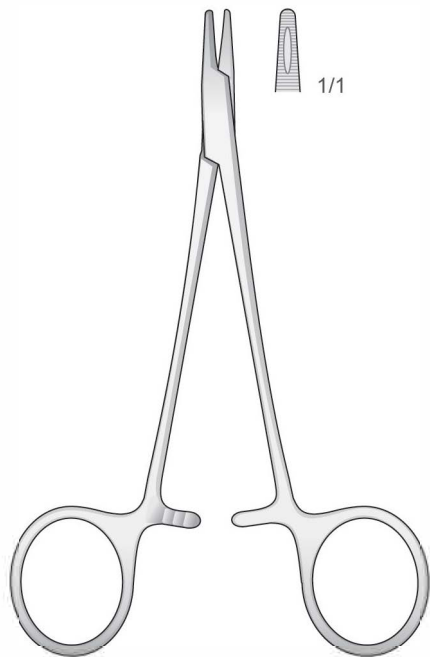

1/1

DERF  
**SI-10865**  
125 mm



1/1 1/1

**SI-10866A SI-10866B**

Mit Glatten maul  
With smooth jaws  
Con morso liscio  
Con mandibula lisa  
Avec mors lisse

**SI-10866**  
120 mm

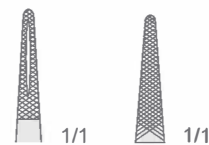
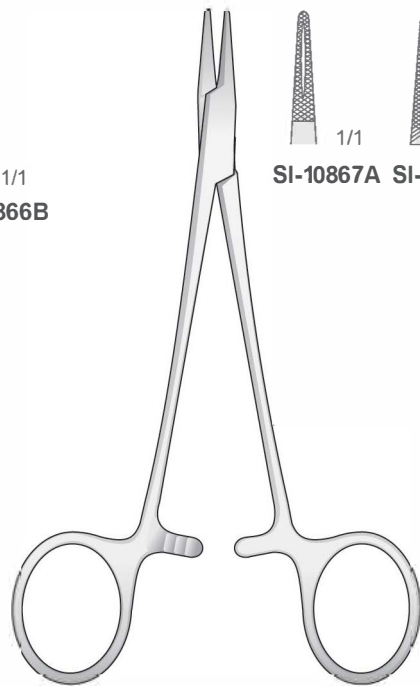

1/1 1/1

**SI-10867A SI-10867B**

HALSEY  
**SI-10867**  
130 mm

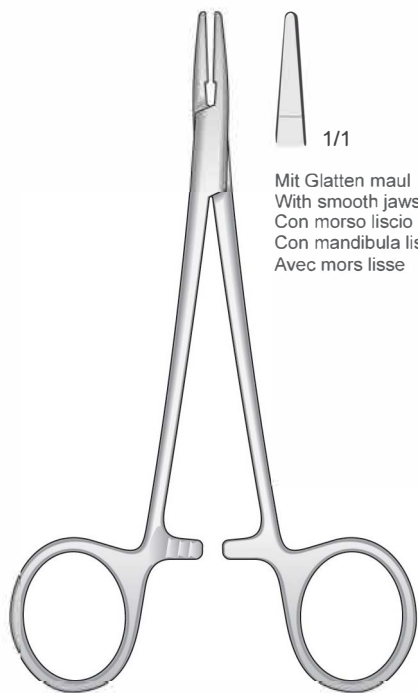

1/1

Mit Glatten maul  
With smooth jaws  
Con morso liscio  
Con mandibula lisa  
Avec mors lisse

HALSEY  
**SI-10868**  
130 mm

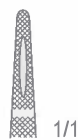
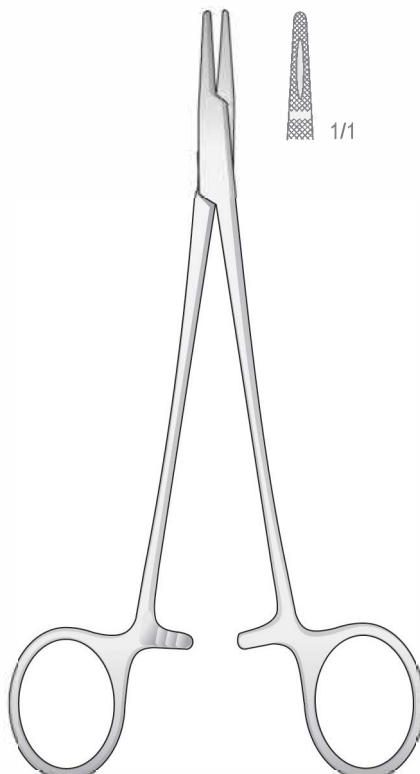

1/1

CRILE-WOOD  
**SI-10869**  
150 mm

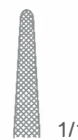
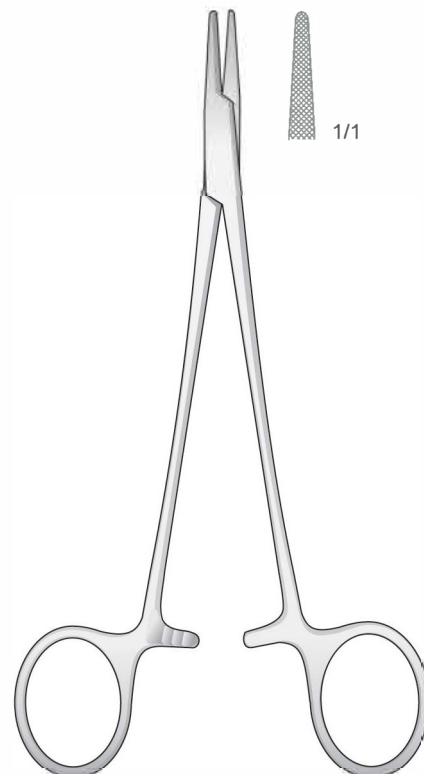

1/1

CRILE-MURRAY  
**SI-10870**  
150 mm



Nadelhalter mit Schere - Needle holders with scissors  
Port'aghi con forbici - Portaagujas con tijeras  
Porte aiguilles avec ciseaux

Nadelhalter  
Needle Holders  
Port'aghi  
Portaagujas  
Porte aiguilles

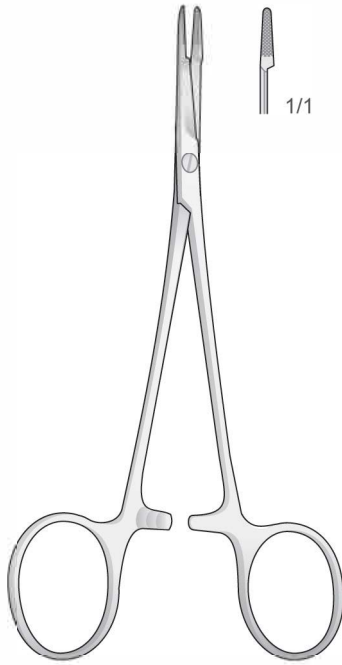

**MINI-OLSEN-HEGAR**  
**SI-10871**  
120 mm

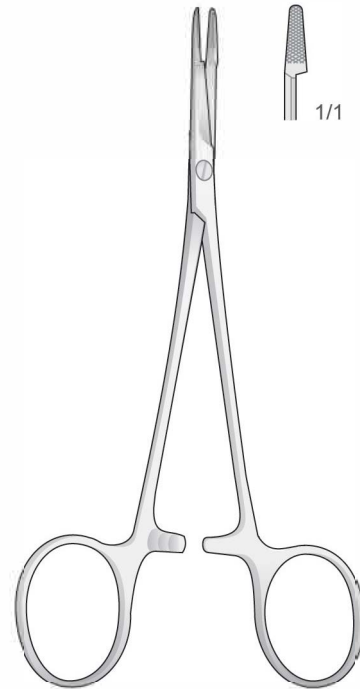

**OLSEN-HEGAR**  
**SI-10872**  
140 mm

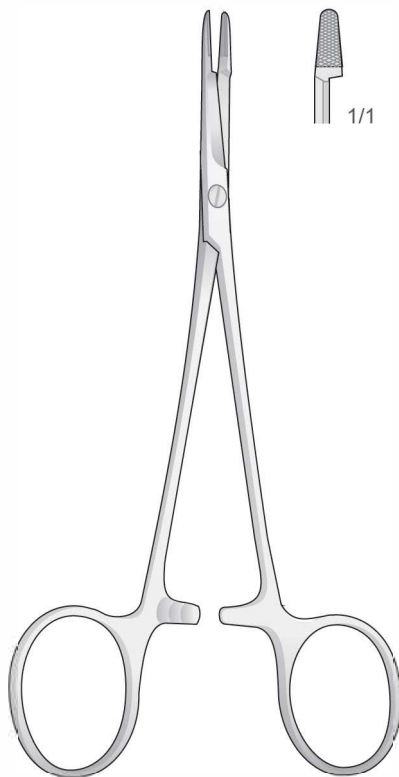

**OLSEN-HEGAR**  
**SI-10873**  
170 mm

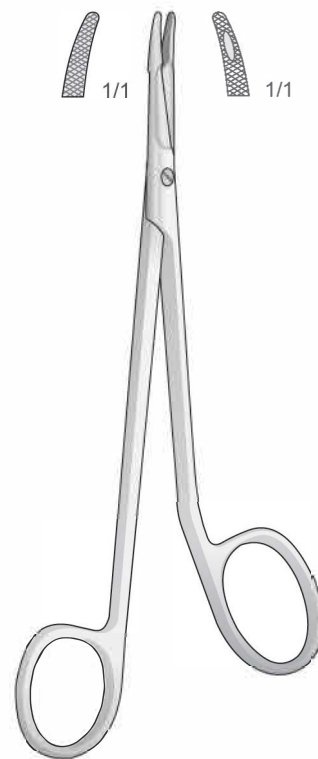

**MINI-GILLIES**  
**SI-10874**  
145 mm



Nadelhalter  
Needle Holders  
Port'aghi  
Portaagujas  
Porte aiguilles

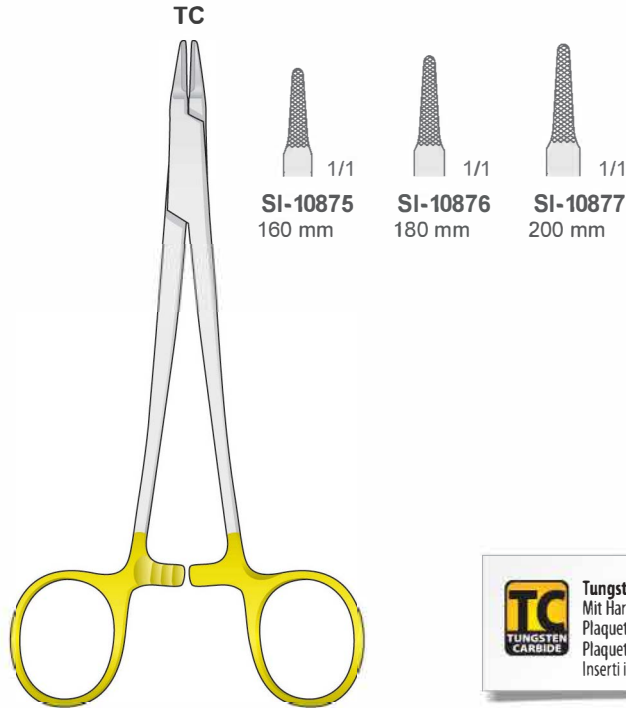

**TC**  
TUNGSTEN  
CARBIDE

**Tungsten-Carbide Inserts**  
Mit Hartmetalleinsätzen  
Plaquettes en carbure de tungstène  
Plaquetas de carburo de tungsteno  
Inserti in carburo di tungsteno

**RYDER**  
**SI-10878**

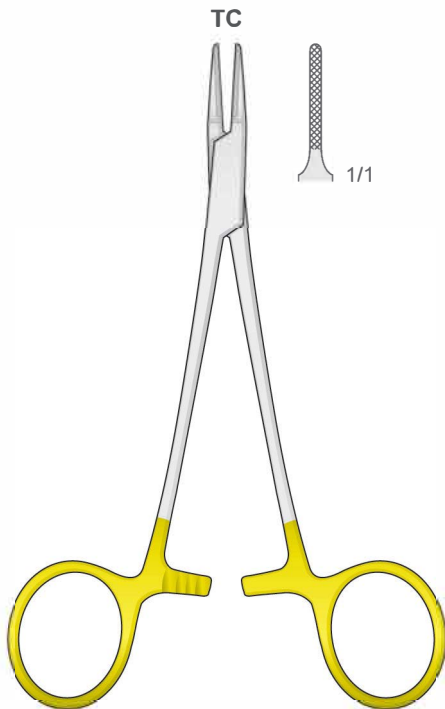

**RYDER**  
**SI-10879**  
140 mm

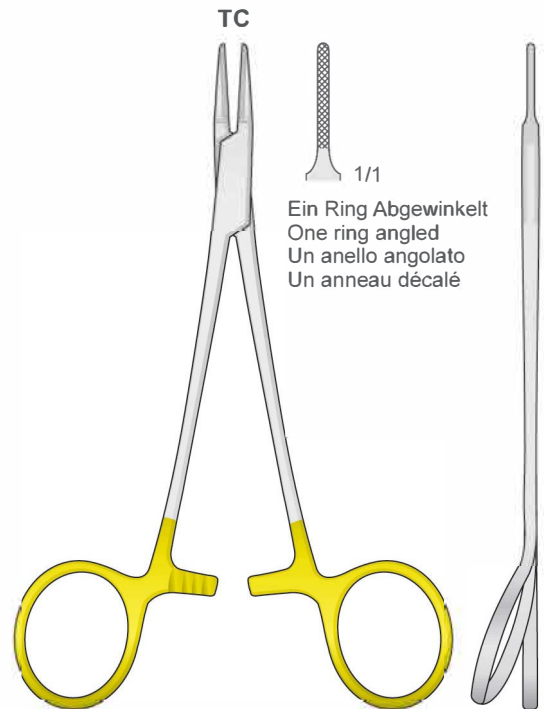

**SI-10880**  
140 mm



Nadelhalter  
Needle Holders  
Port'aghi  
Portaagujas  
Porte aiguilles

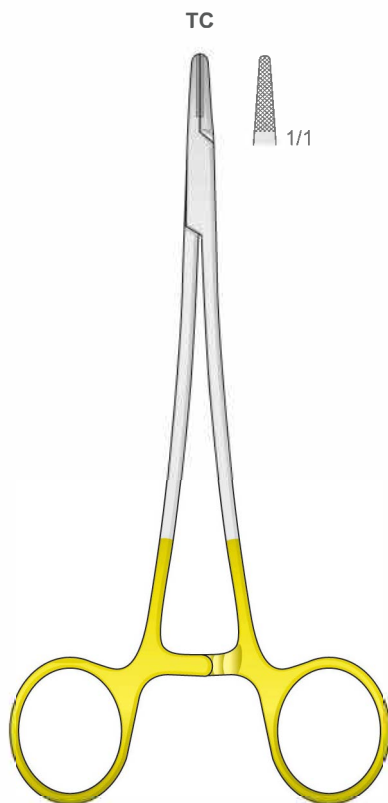

**SI-10881**  
145 mm

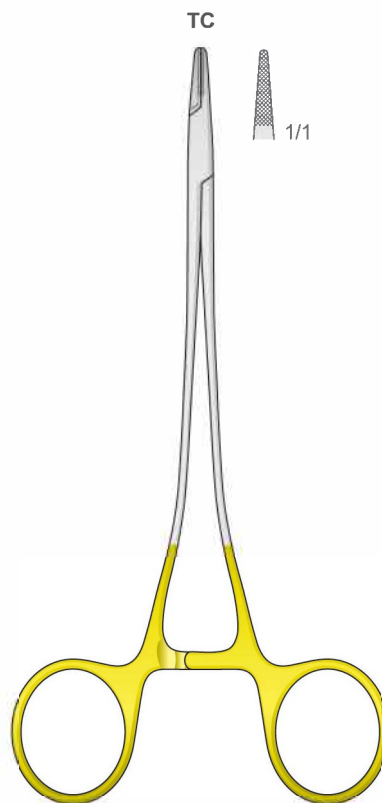

FINE SWEDISH PATTERN  
**SI-10882**  
150 mm

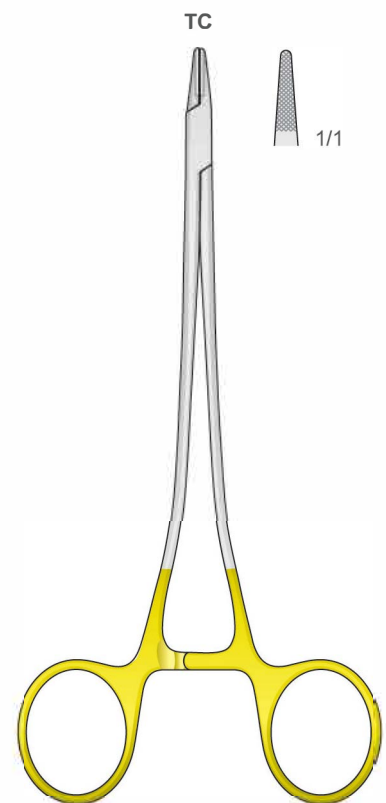







SWEDISH  
MOD. **SI-10883**  
150 mm

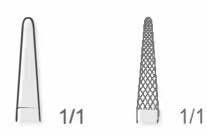
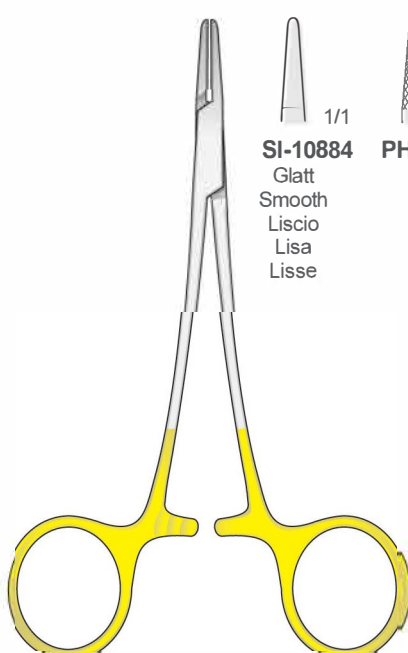

Nadelhalter  
Needle Holders  
Port'aghi  
Portaagujas  
Porte aiguilles

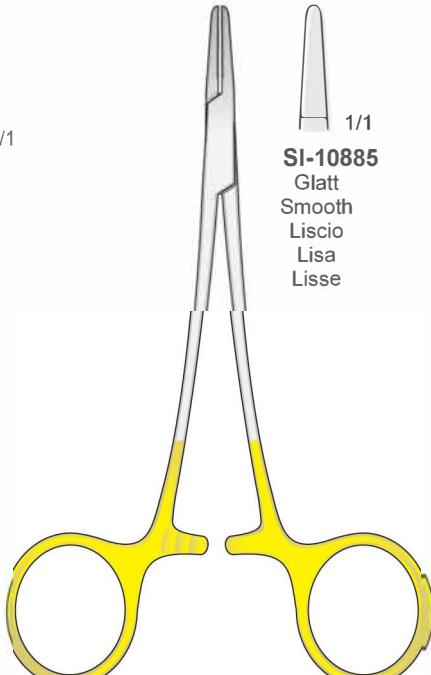

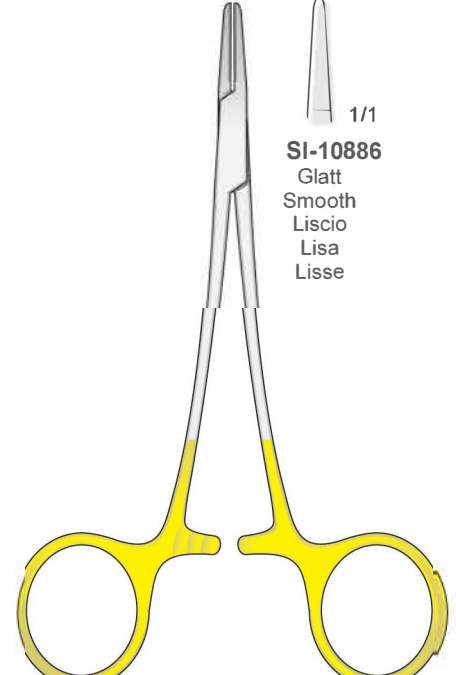
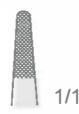
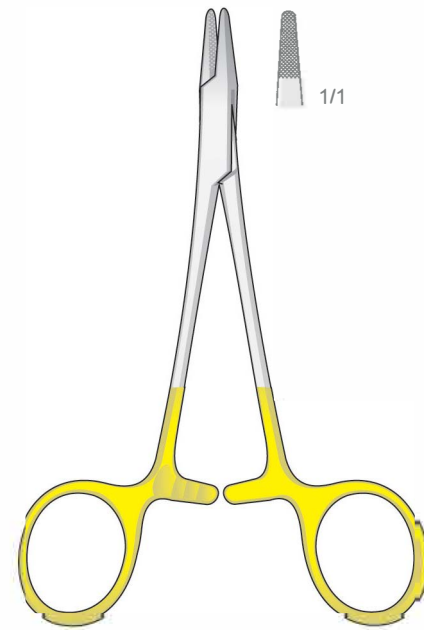
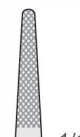
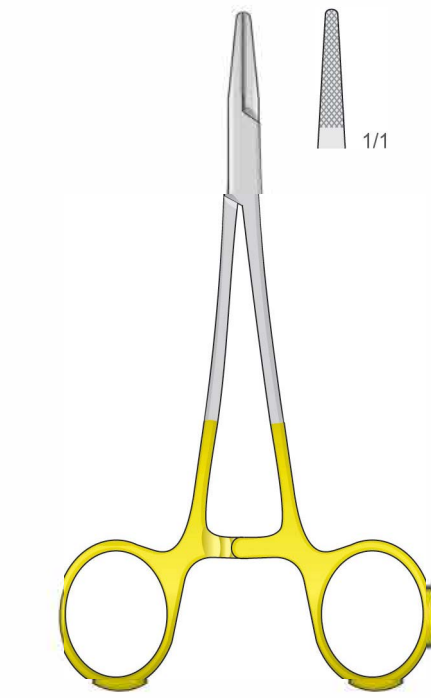
**Tungsten-Carbide Inserts**  
Mit Hartmetalleinsätzen  
Plaquettes en carbure de tungstène  
Plaquetas de carburo de tungsteno  
Inserti in carburo di tungsteno

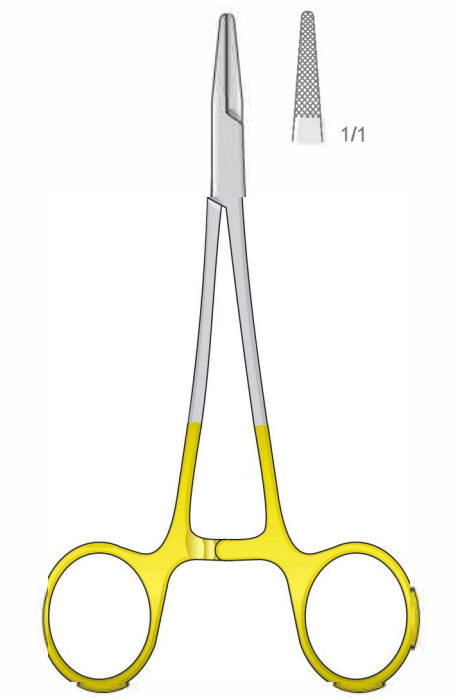
<p><b>TC</b></p>  <p><b>SI-10884</b> Glatt Smooth Liscio Lisa Lisse</p> <p><b>PH-65</b></p>  <p><b>SI-10887</b> 120 mm</p>	<p><b>TC</b></p>  <p><b>SI-10885</b> Glatt Smooth Liscio Lisa Lisse</p>  <p><b>WEBSTER</b> <b>SI-10888</b> 130 mm</p>	<p><b>TC</b></p>  <p><b>SI-10886</b> Glatt Smooth Liscio Lisa Lisse</p>  <p><b>HALSEY</b> <b>SI-10889</b> 130 mm</p>
<p><b>TC</b></p>  <p><b>DERF</b> <b>SI-10890</b> 115 mm</p> 	<p><b>TC</b></p>  <p><b>CONVERSE</b> <b>SI-10891</b> 130 mm</p> 	<p><b>TC</b></p>  <p><b>HALSEY</b> <b>SI-10892</b> 130 mm</p> 





Nadelhalter  
Needle Holders  
Port'aghi  
Portaagujas  
Porte aiguilles



**Tungsten-Carbide Inserts**  
Mit Hartmetalleinsätzen  
Plaquettes en carbure de tungstène  
Plaquetas de carburo de tungsteno  
Inserti in carburo di tungsteno

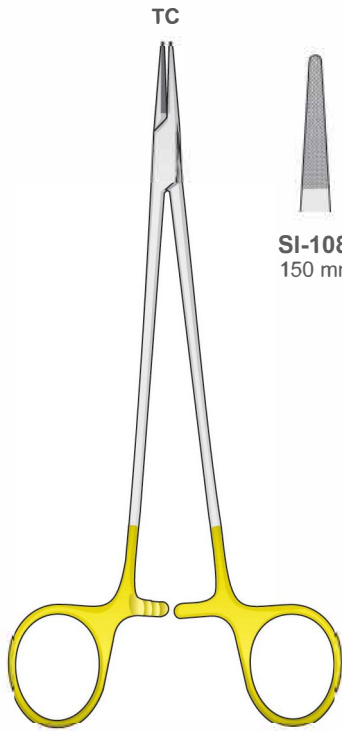

DE BAKEY  
SI-10898

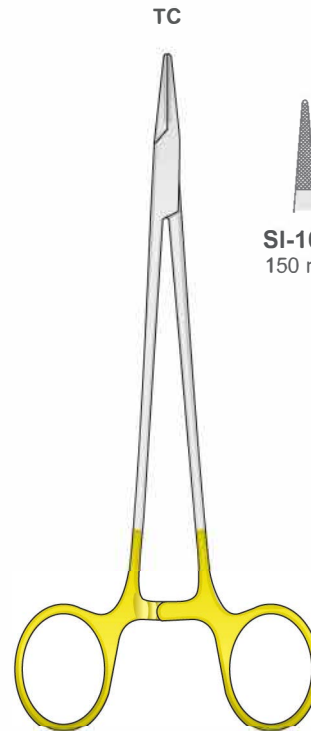
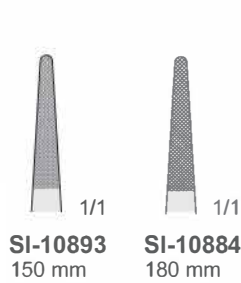

MICRO-VASCULAR  
SI-10899

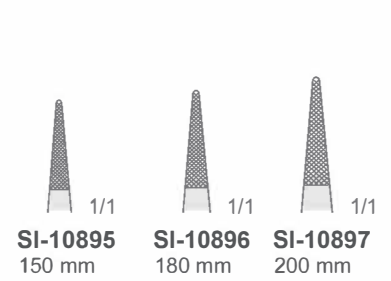

Vascular  
Vaskuläre  
Vasculaire  
Vasculares  
Vascolari

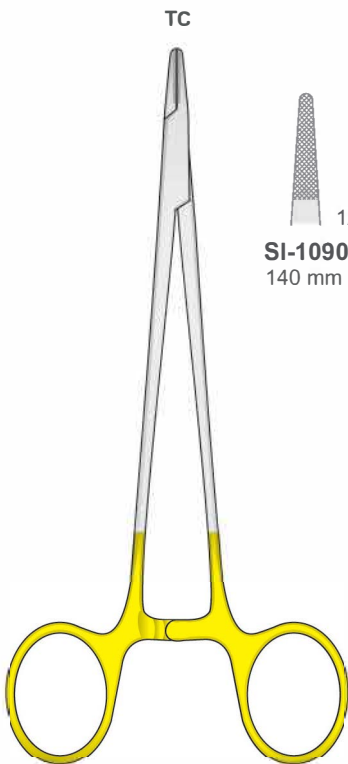

MAYO-HEGAR  
SI-10906

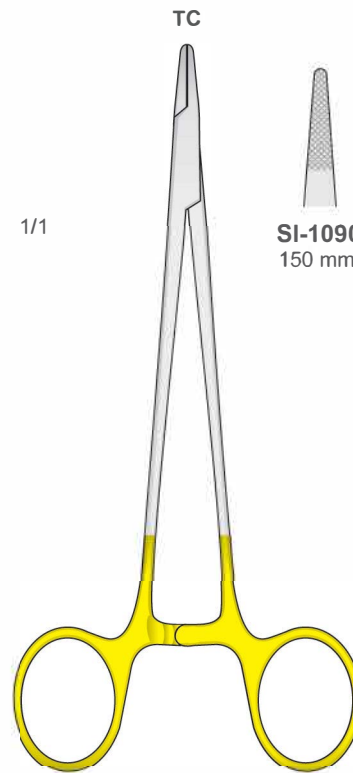
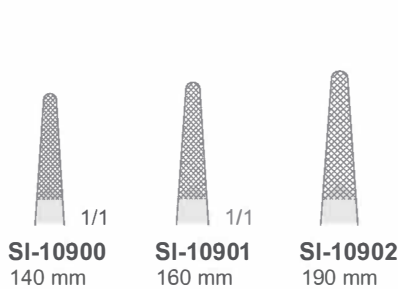

MAYO-HEGAR-FINO  
SI-10907

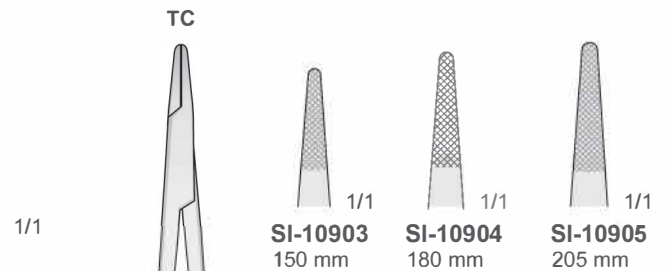



IV  
N  
Pc  
Pc  
Pc

Chirurgische Pinzetten - Anatomische Pinzette

Tissue Forceps - Dressing forceps  
Pinzette chirurgiche - Pinzette anatomiche  
Pinzas quirurgicas - Pinzas de diseccion  
Pincas quirurgicales - Pincas anatomiques



**SI-10914**



1/1

**SI-10908**  
130 mm



1/1

**SI-10909**  
180 mm



1/1

**SI-10910**  
200 mm



**SI-10915**



1/1

**SI-10911**  
230 mm



1/1

**SI-10912**  
250 mm



1/1

**SI-10913**  
300 mm



**SI-10921**

1x2 Zähne  
1x2 Teeth  
1x2 Denti  
1x2 Dientes  
1x2 Dents

Schmal - Narrow  
Strette - Estrechas  
Étroites



1/1

**SI-10916**  
115 mm



1/1

**SI-10917**  
130 mm



1/1

**SI-10918**  
145 mm



1/1

**SI-10919**  
160 mm



1/1

**SI-10920**  
180 mm



1/1

**SI-10921**  
200 mm



Nadelhalter  
Needle Holders  
Port'aghi  
Portaaguja  
Porte aiguilles



**Tungsten-Carbide Inserts**  
Mit Hartmetalleinsätzen  
Plaquettes en carbure de tungstène  
Plaquetas de carburo de tungsteno  
Inserti in carburo di tungsteno

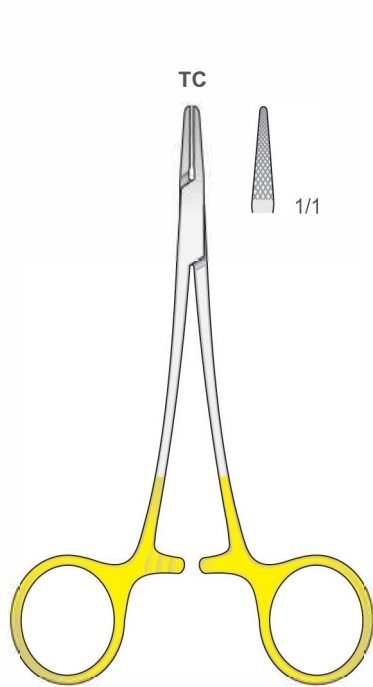

**SI-10922**  
120 mm

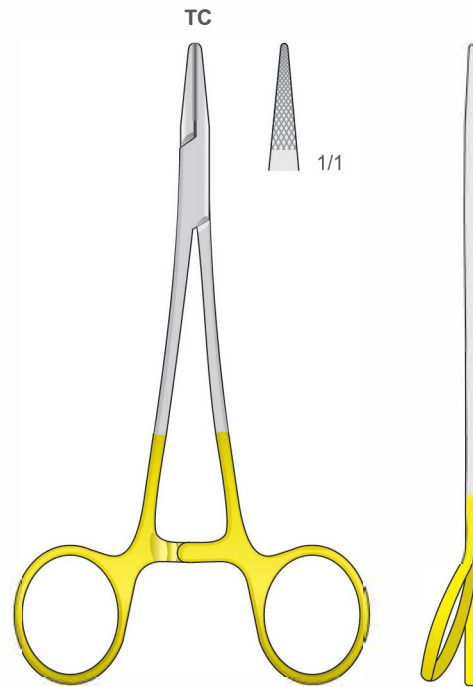

**CRILE-WOOD**  
**SI-10923**  
150 mm

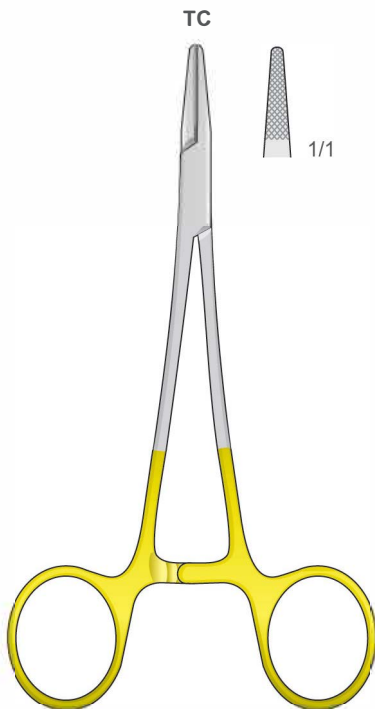

**BABY-CRILE-  
WOOD SI-10924**  
150 mm

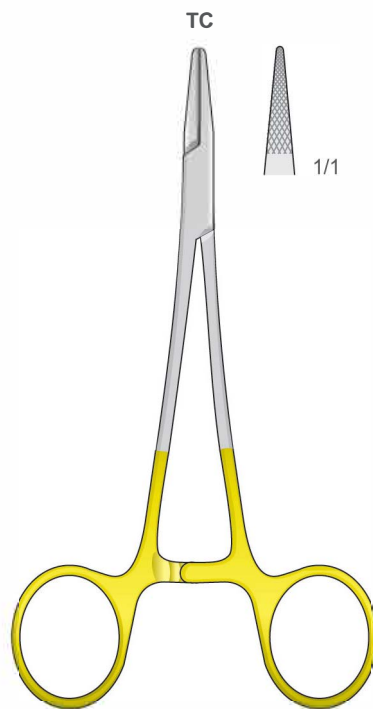

**CRILE-WOOD**  
**SI-10925**  
150 mm



**CRILE-WOOD**  
**SI-10926**  
150 mm



Nadematier  
Needle Holders  
Port'aghi  
Portaagujas  
Porte aiguilles

**TC**  
TUNGSTEN  
CARBIDE

**Tungsten-Carbide Inserts**  
Mit Hartmetalleinsätzen  
Plaquettes en carbure de tungstène  
Plaquetas de carburo de tungsteno  
Inserti in carburo di tungsteno

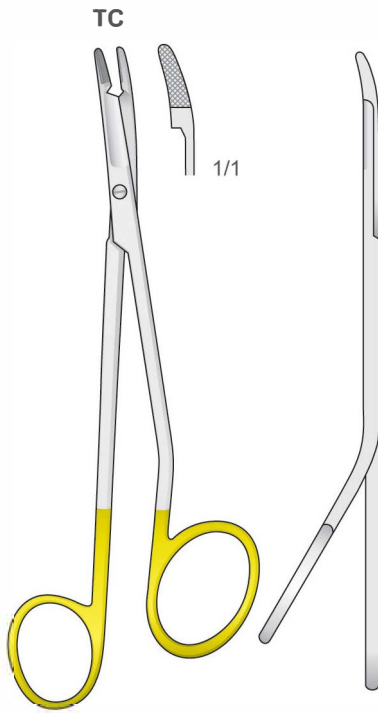

**MINI-GILLIES**  
**SI-10927**  
145 mm

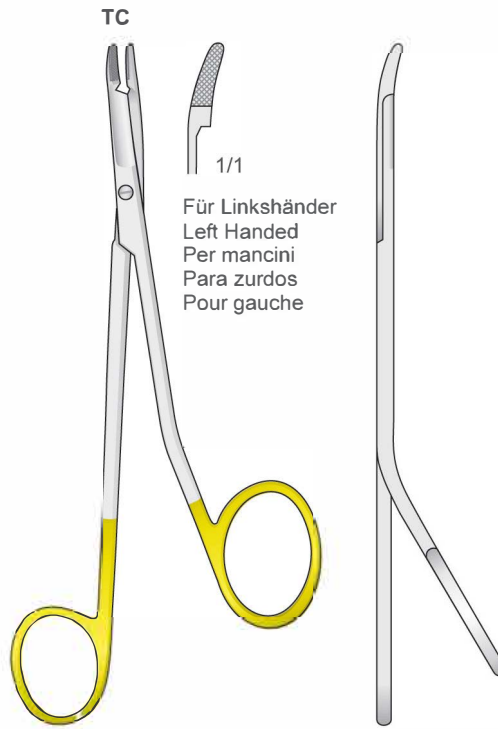

**MINI-GILLIES**  
**SI-10928**  
145 mm

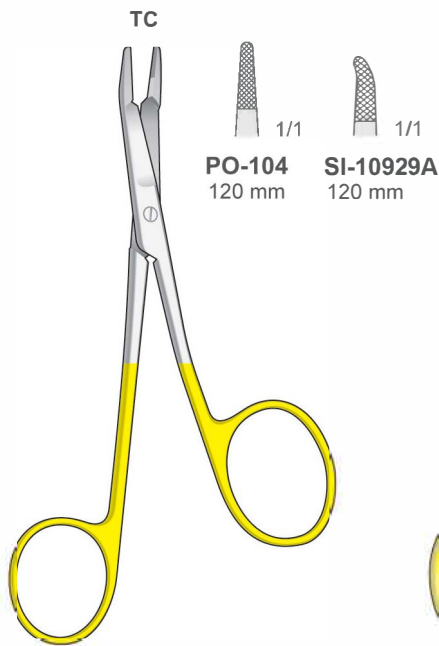

**FOSTER-GILLIES**  
**SI-10929**  
120 mm

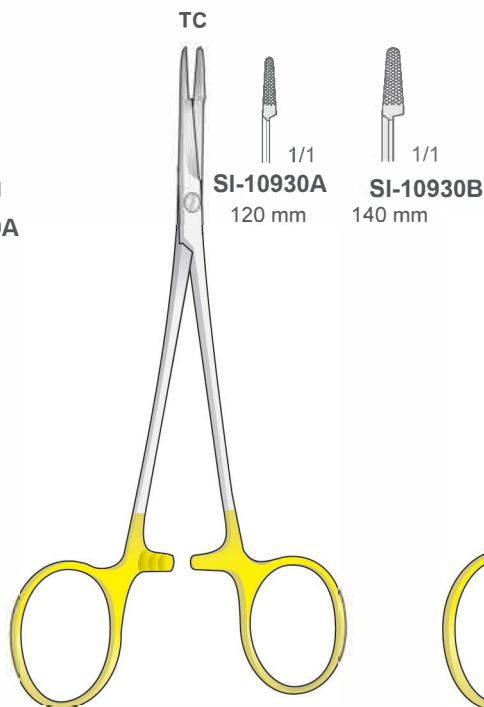

**OLSEN-HEGAR**  
**SI-10930**

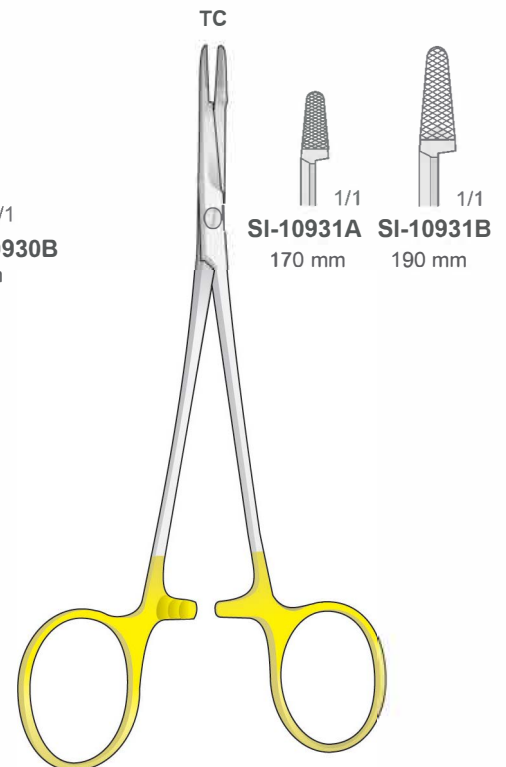

**OLSEN-HEGAR**  
**SI-10931**



Nadelhalter  
Needle Holders  
Port'aghi  
Portaaguja  
Porte aiguilles

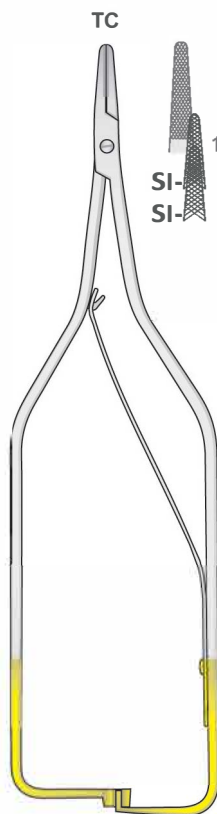

**ABRUGA**  
SI-0937  
160 mm

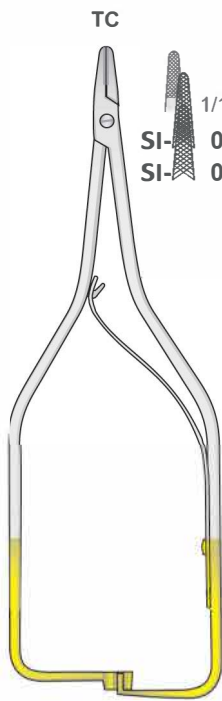
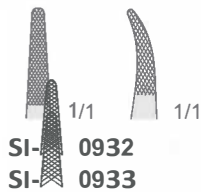

**BRYNNTON**  
SI-0938  
120 mm

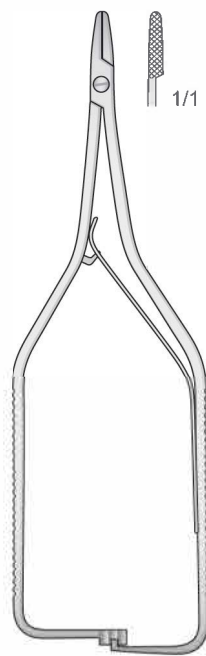
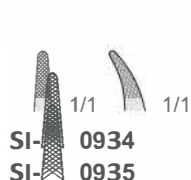

**BOYNTON**  
SI-0939  
120 mm

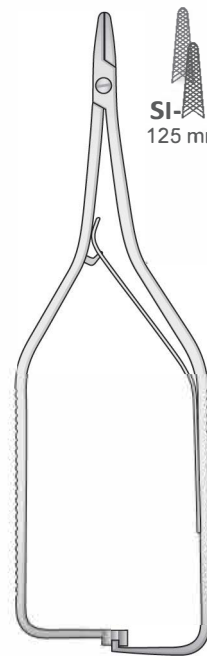

**BOYNTON**  
SI-0940  
125 mm

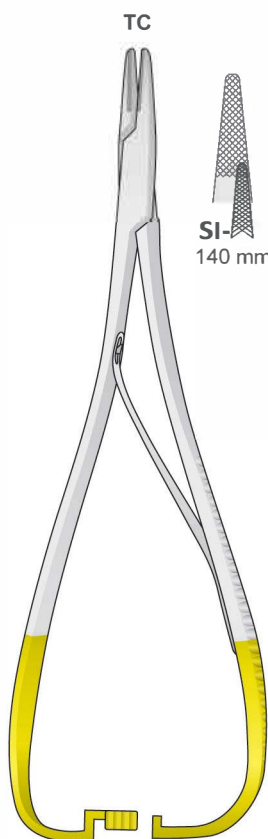

**MATHIEU**  
SI-0945

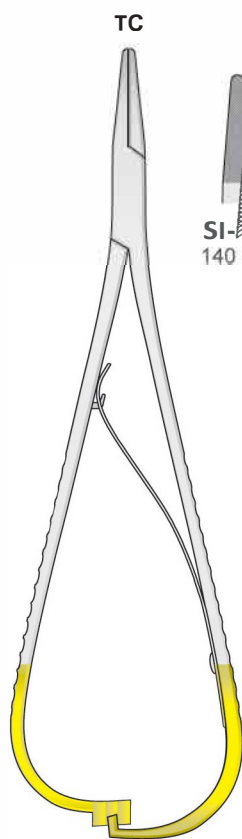
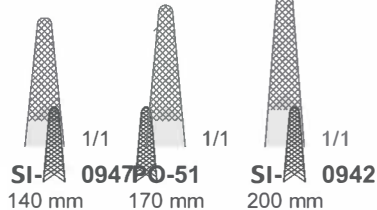

**MATHIEU**  
SI-0946

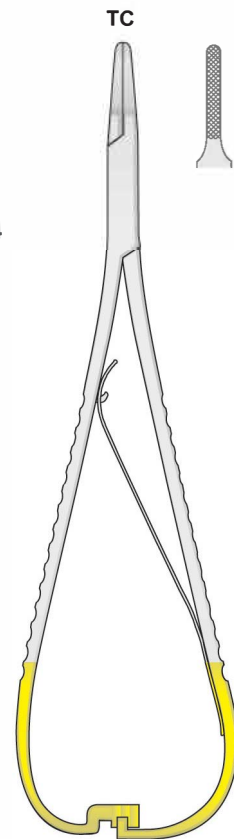
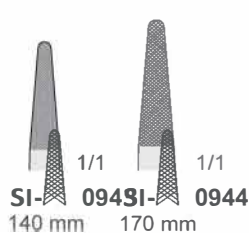

**LICHTENBERG**  
SI-0947  
175 mm

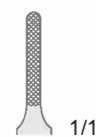



Chirurgische Pinzetten - Anatomische Pinzetten

Tissue Forceps - Dressing forceps  
Pinzette chirurgische - Pinzette anatomica  
Pinzas quirúrgicas - Pinzas de disección  
Pinces chirurgicales - Pinces anatomiques

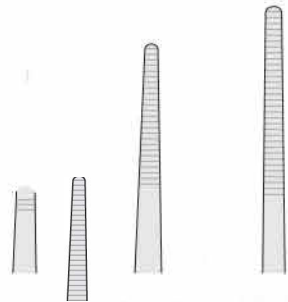

1/1 1/1 1/1  
**SI-10785** 130 mm  
**SI-10786** 180 mm  
**SI-10787** 200 mm

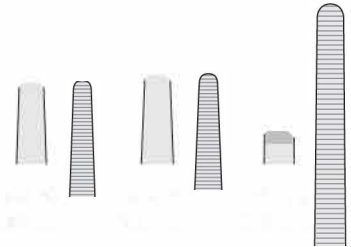

1/1 1/1 1/1  
**SI-10788** 230 mm  
**SI-10789** 250 mm  
**SI-10790** 300 mm

**SI-10791**



**SI-10792**

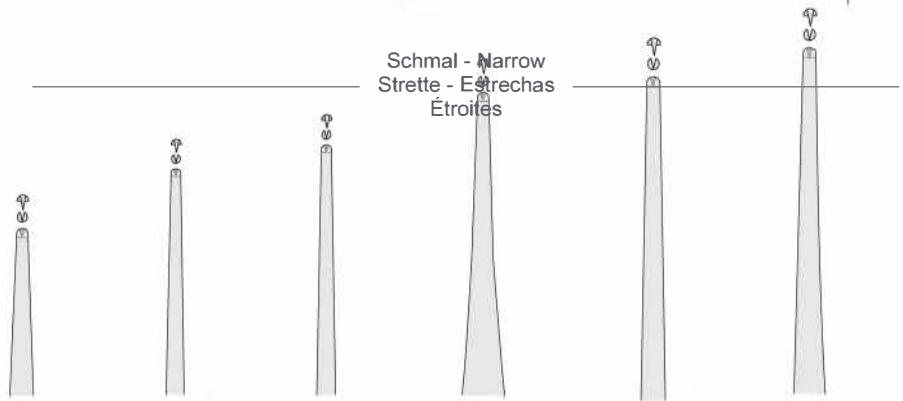

1/1 1/1 1/1 1/1 1/1 1/1  
**SI-10793** 115 mm  
**SI-10794** 130 mm  
**SI-10795** 145 mm  
**SI-10796** 160 mm  
**SI-10797** 180 mm  
**SI-10798** 200 mm

1x2 Zähne  
1x2 Teeth  
1x2 Denti  
1x2 Dientes  
1x2 Dents





Nadelhalter  
Needle Holders  
Port'aghi  
Portaaguja  
Porte aiguilles

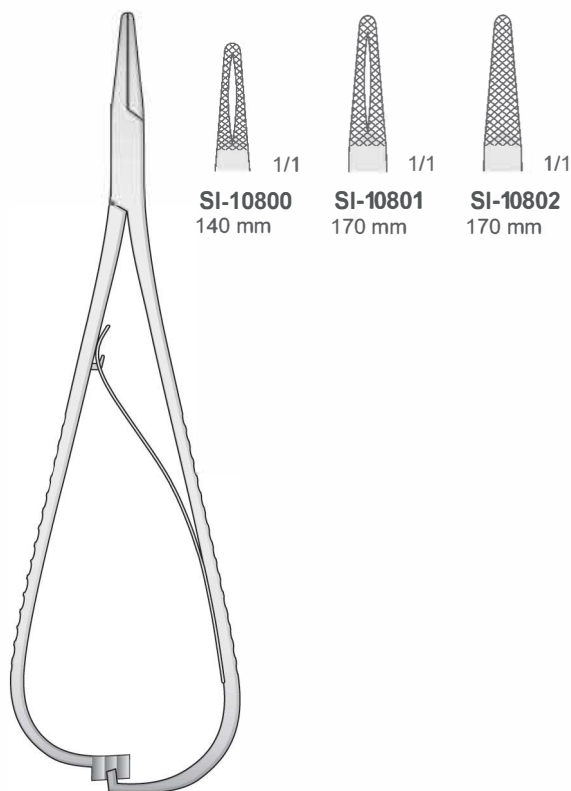

**SI-10800**  
140 mm

**SI-10801**  
170 mm

**SI-10802**  
170 mm

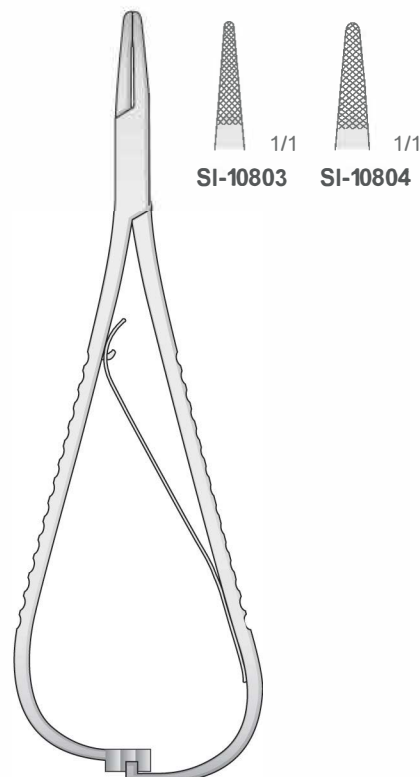

**SI-10803**

**SI-10804**

MATHIEU  
**SI-10805**

MATHIEU  
**SI-10806**  
140 mm

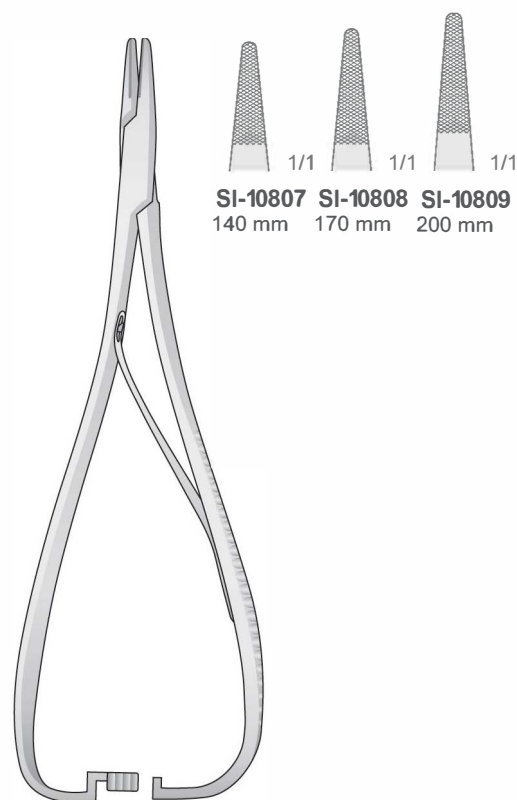

**SI-10807** **SI-10808** **SI-10809**  
140 mm 170 mm 200 mm

MATHIEU  
**SI-10810**

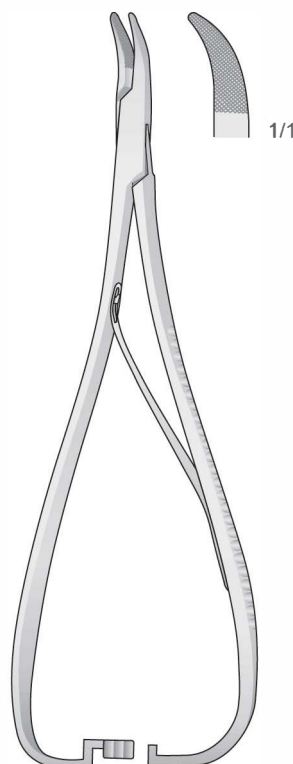

**SI-10811**  
140 mm



Nadelhalter  
Needle Holders  
Port'aghi  
Portaagujas  
Porte aiguilles

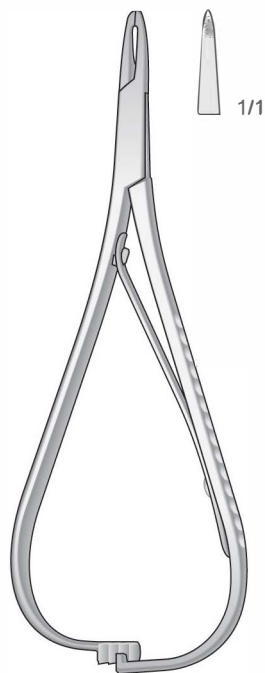

MATHIEU  
**SI-10815**  
125 mm

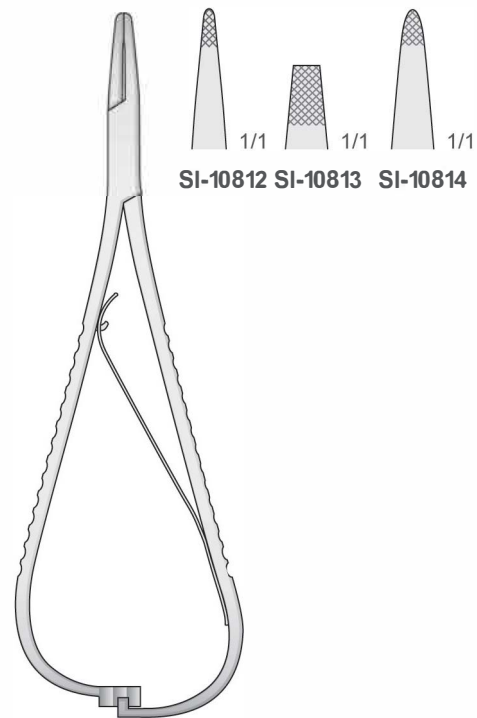

MATHIEU  
**SI-10816**  
140 mm

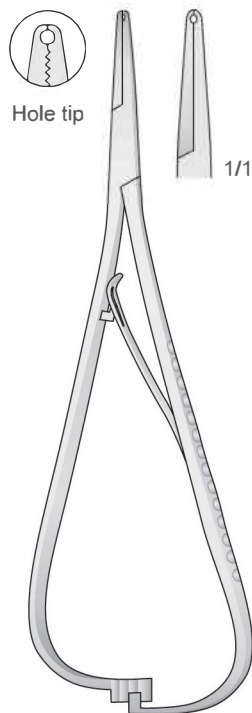

SMAHA  
**SI-10817**  
140 mm

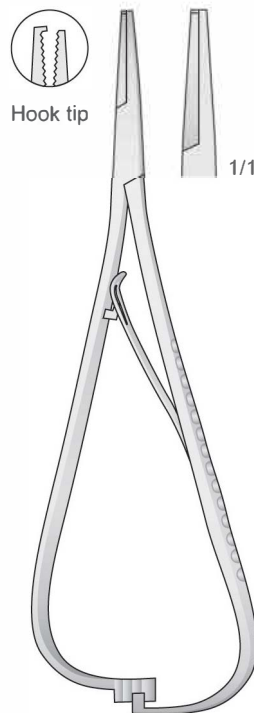

SMAHA  
**SI-10818**  
140 mm

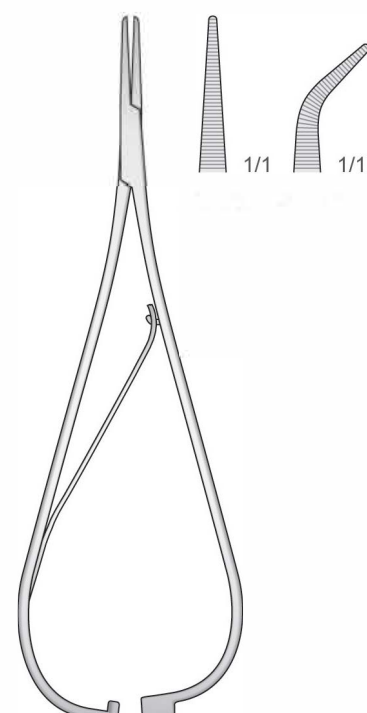

SMAHA  
**SI-10819**  
140 mm



Tuchklemmen  
Towel Clamps  
Fissateli  
Pinzas de campo  
Pincas fixe-compresses

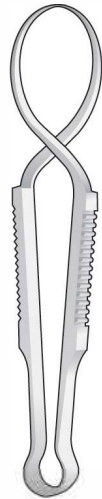

**SCHAEDEL**  
**SI-10820**  
85 mm

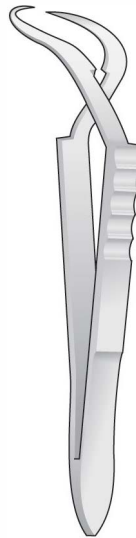

**JONES**  
**SI-10821**  
90 mm



**FAURE**  
**SI-10822**  
85 mm

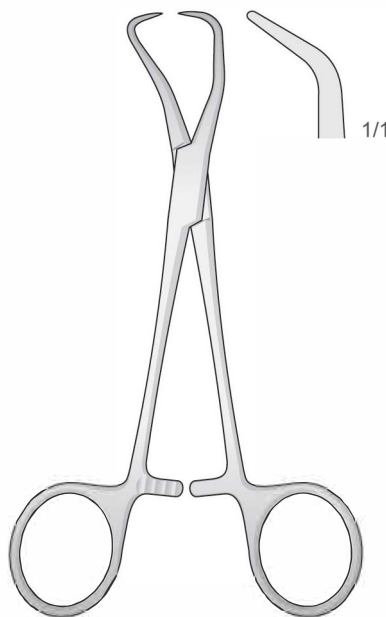

**BACKHAUS**  
**SI-10829**

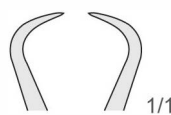

**SI-108233**  
90 mm

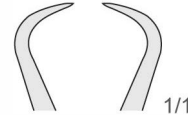

**SI-10824**  
100 mm

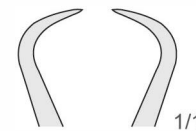

**SI-10825**  
110 mm

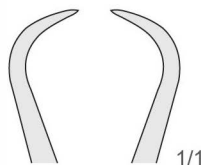

**SI-10826**  
130 mm

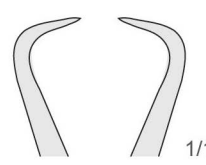

**SI-10827**  
135 mm

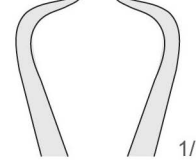

**SI-10828**  
140 mm



Tuchklippen  
Towel Clamps  
Fissateli  
Pinzas de campo  
Pincas fixe-compresses

Für Papiertücher  
For paper cloths  
Per teli di carta  
Para paños  
Pour papier

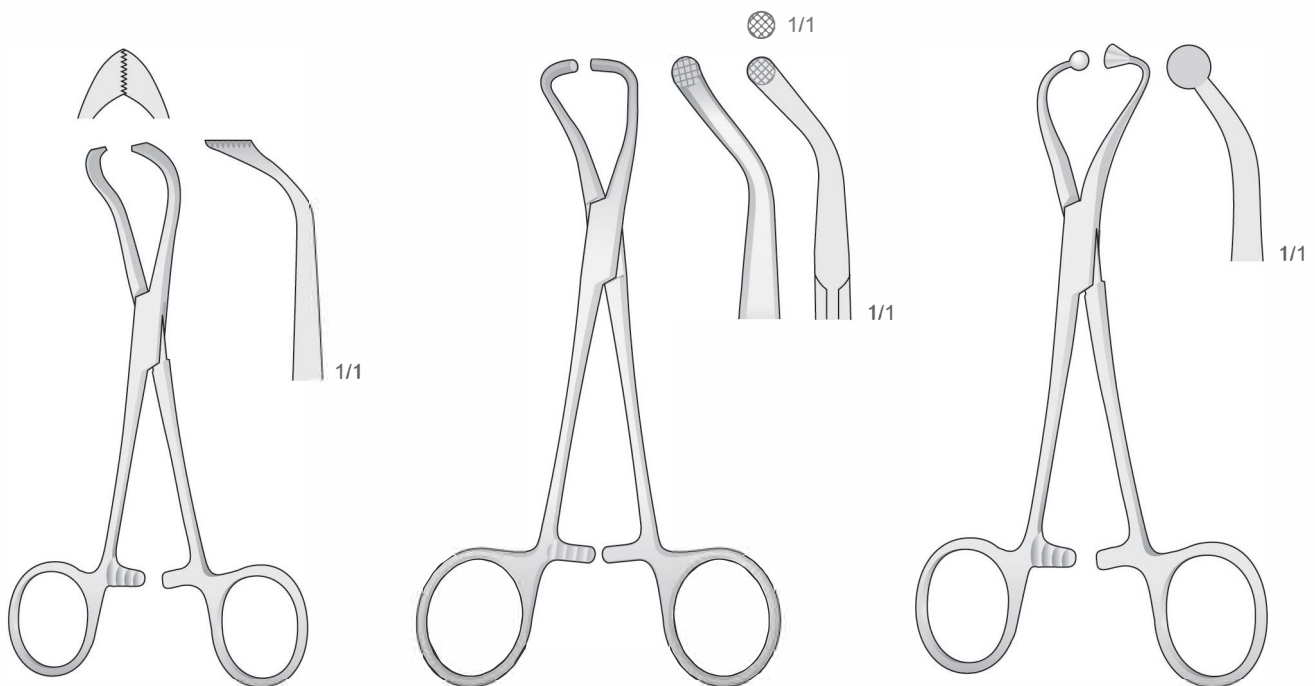

**LORNA**  
**SI-10830**  
100 mm

**SI-10831**  
130 mm

**SI-10832**  
140 mm



Arterienklemmen  
Hemostatic Forceps  
Pinze emostatiche  
Pinzas hemostáticas  
Pinces hémostatiques

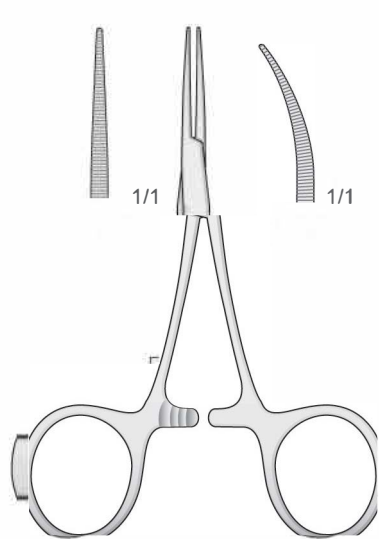

HARTMANN/BABY-MOSQUITO  
**SI-10833**  
95 mm

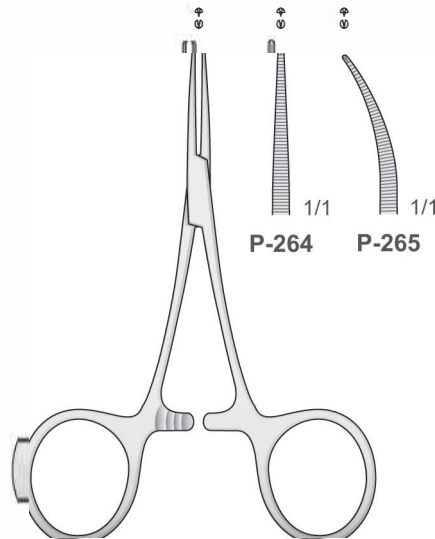

HARTMANN/BABY-MOSQUITO  
**SI-10834**  
95 mm

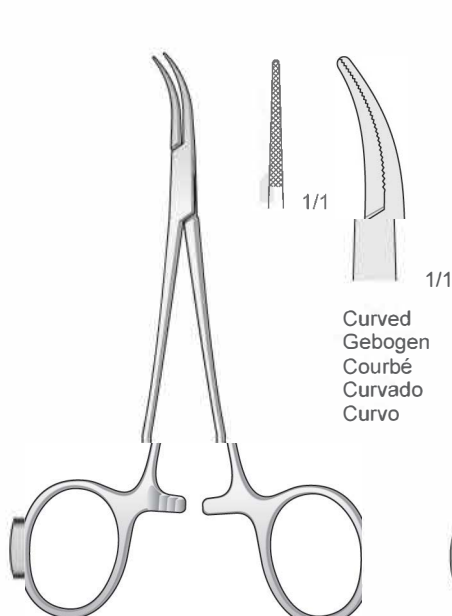

DANDY-MOSQUITO  
**SI-10835**  
120 mm

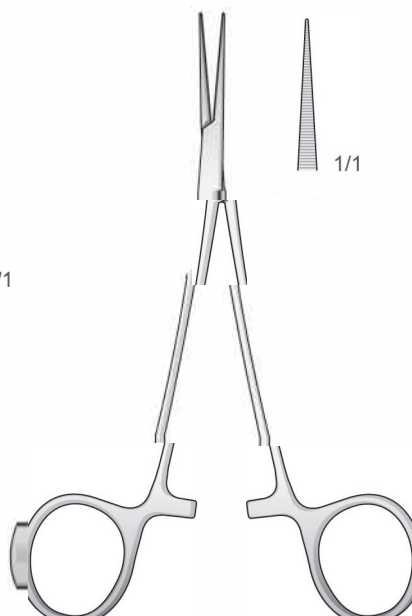

JACOBSON-MICRO  
**SI-10836**  
130 mm

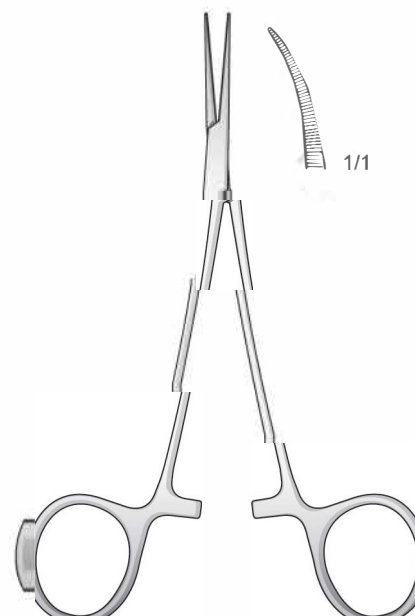

JACOBSON-MICRO  
**SI-10837**  
130 mm



Arterienklemmen  
Hemostatic Forceps  
Pinze emostatiche  
Pinzas hemostáticas  
Pincas hémostatiques

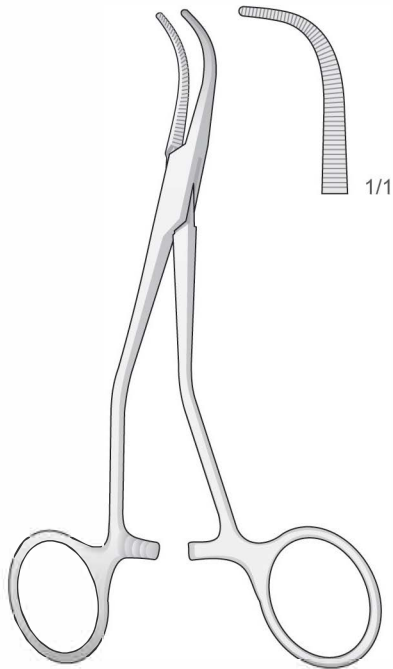

**SI-10838**  
130 mm



PEET  
**SI-10839**  
120 mm

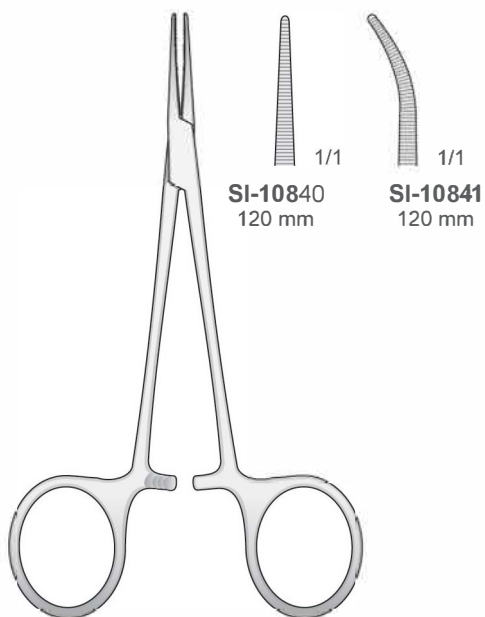

**SI-10840**  
120 mm

**SI-10841**  
120 mm

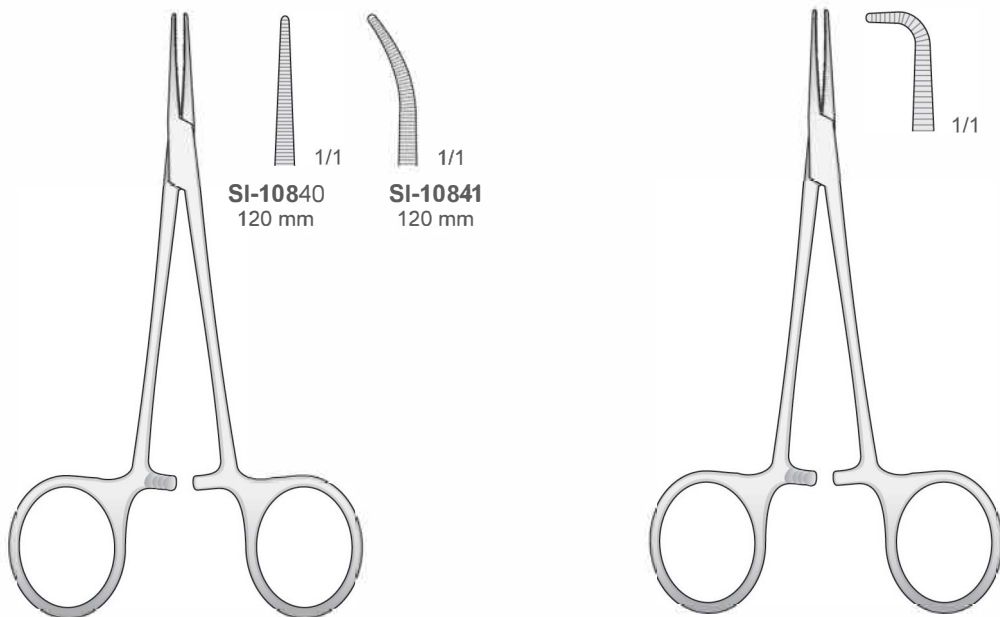

MICRO-HALSTED  
**SI-10842**

MICRO-HALSTED  
**SI-10843**  
115 mm





Arterienklemmen

Hemostatic Forceps  
Pinze emostatiche  
Pinzas hemostáticas  
Pinces hémostatiques

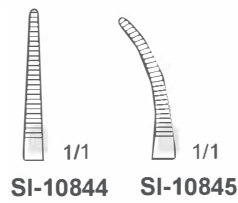
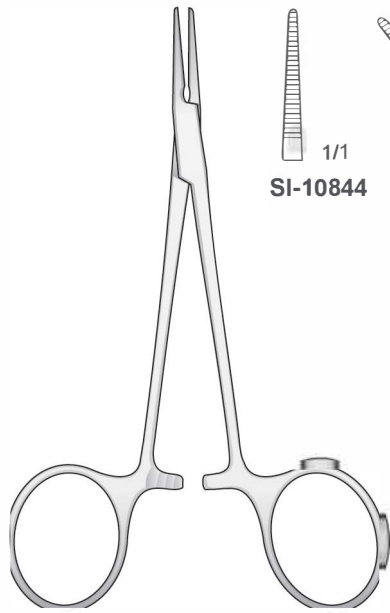

HALSTED  
**SI-10848**  
125 mm

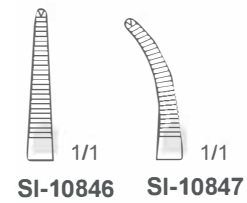
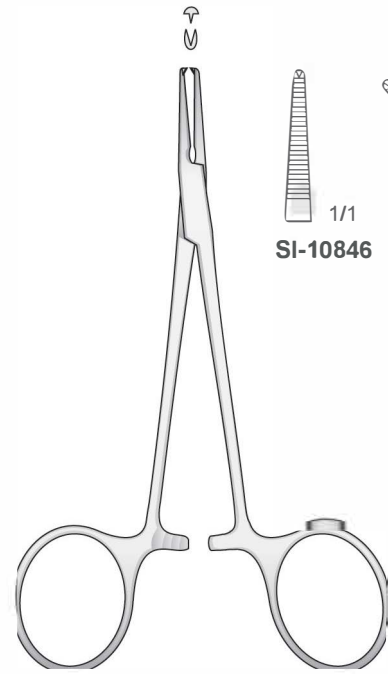

HALSTED  
**SI-10849**  
125 mm

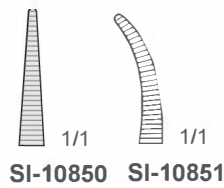
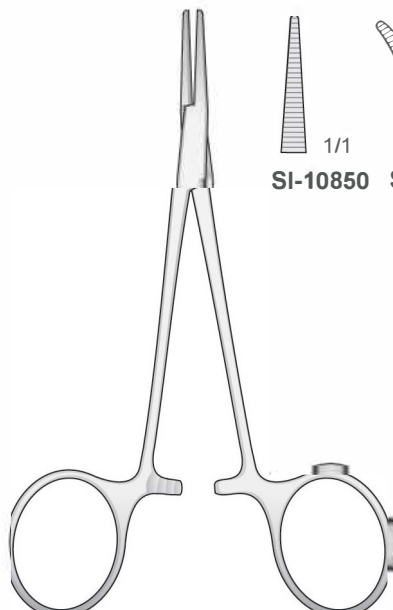

HALSTED-MOSQUITO  
**SI-10854**  
120 mm

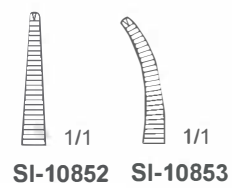
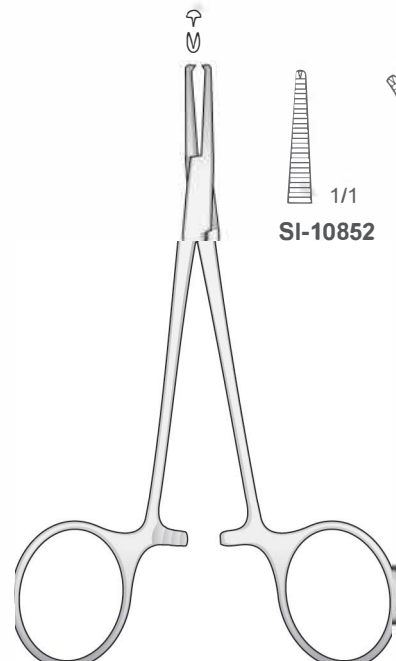

HALSTED-MOSQUITO  
**SI-10855**  
120 mm



Arterienklemmen  
Hemostatic Forceps  
Pinze emostatiche  
Pinzas hemostáticas  
Pincas hémostatiques

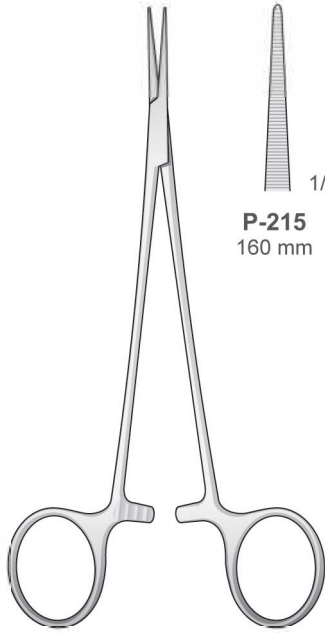

**SI-10860**  
160 mm

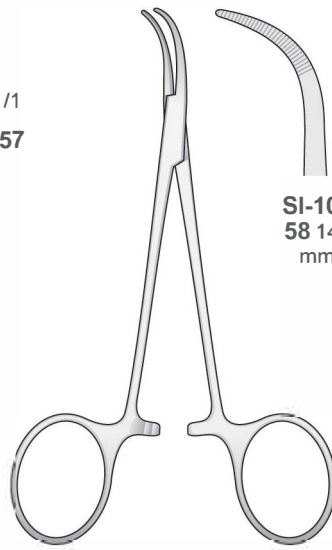
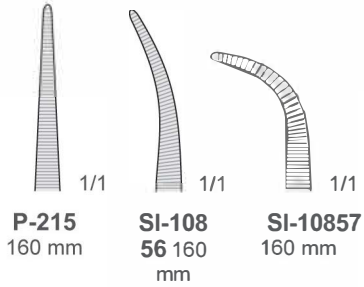

**BABY-MIXTER**  
**SI-10861**

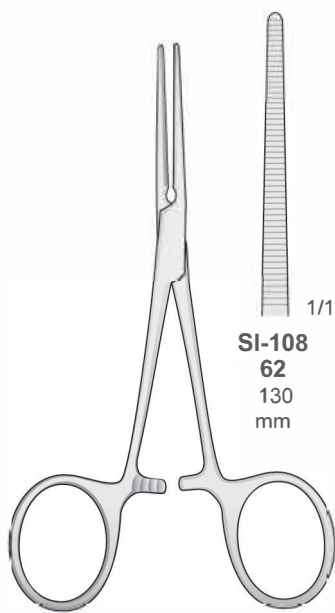
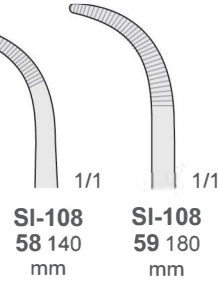

**PEAN**  
**SI-10870**

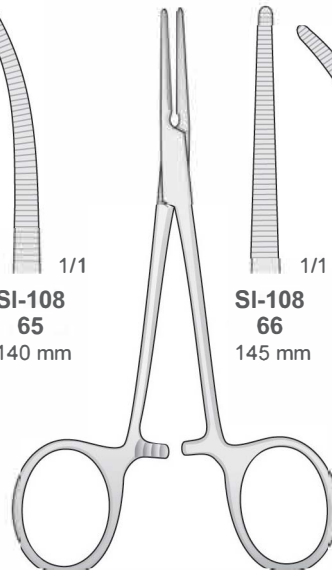
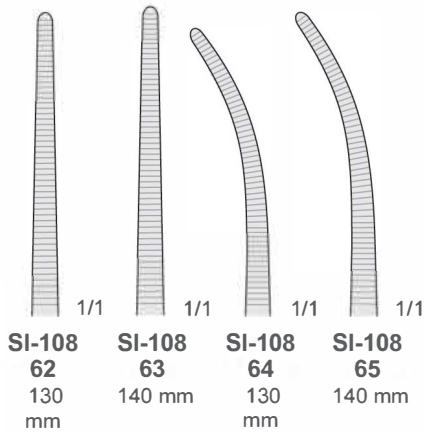

**PEAN**  
**SI-10871**

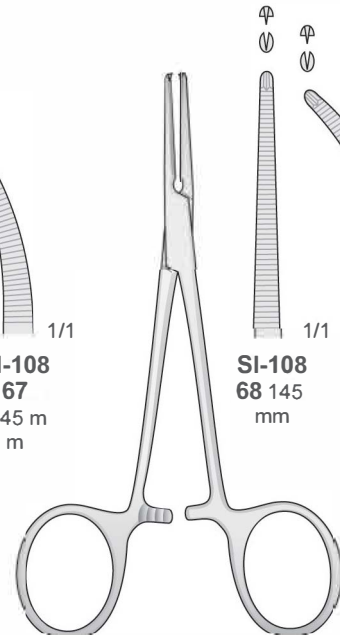
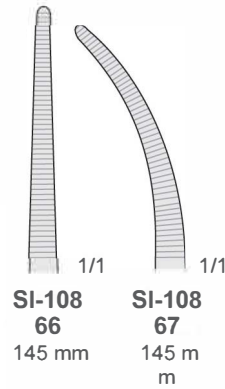

**KOCHER**  
**SI-10872**

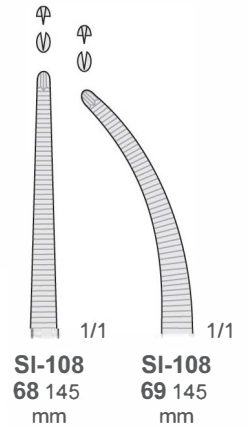



Arterienklemmen  
Hemostatic Forceps  
Pinze emostatiche  
Pinzas hemostáticas  
Pincas hémostatiques

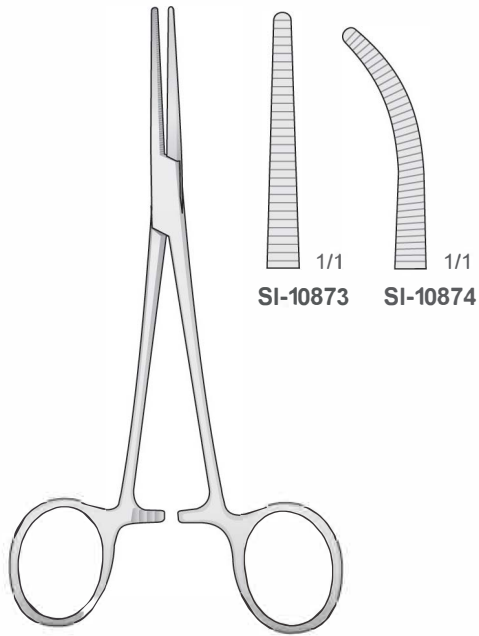

CRILE  
SI-10877  
140 mm

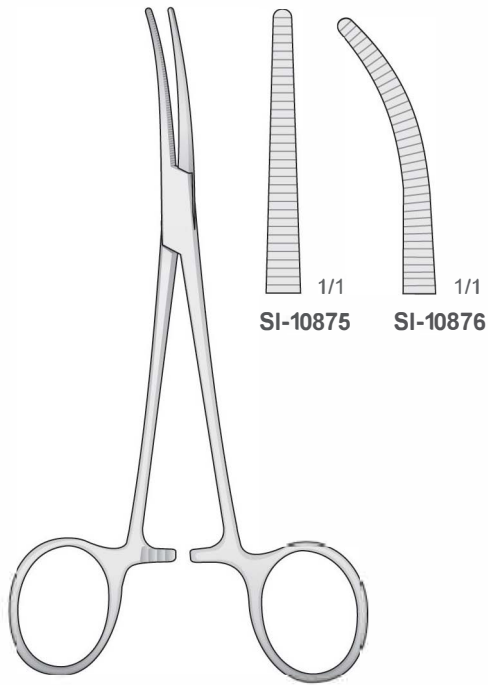

CRILE  
SI-10878  
160 mm

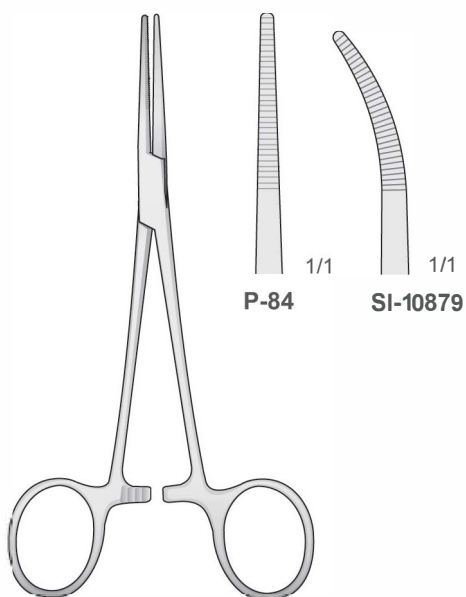

KELLY  
SI-10883  
140 mm

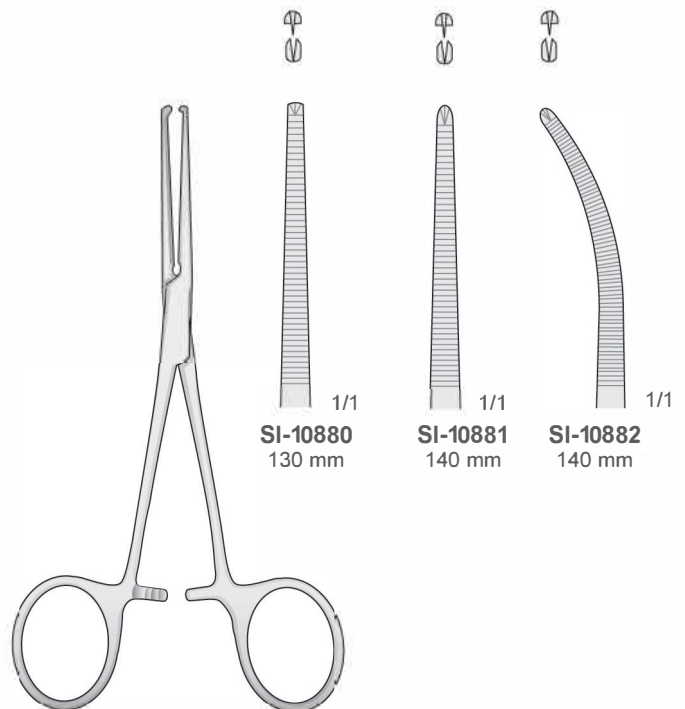

KOCHER  
SI-10884



Arterienklemmen  
Hemostatic Forceps  
Pinze emostatiche  
Pinzas hemostáticas  
Pincas hémostatiques

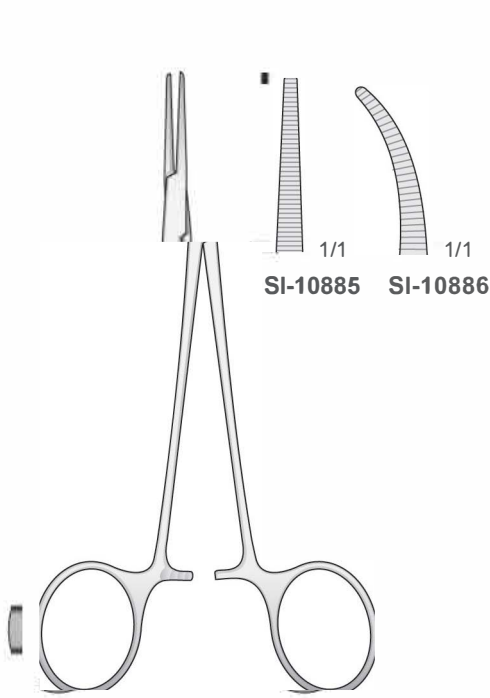

**LERICHE**  
**SI-10889**  
150 mm

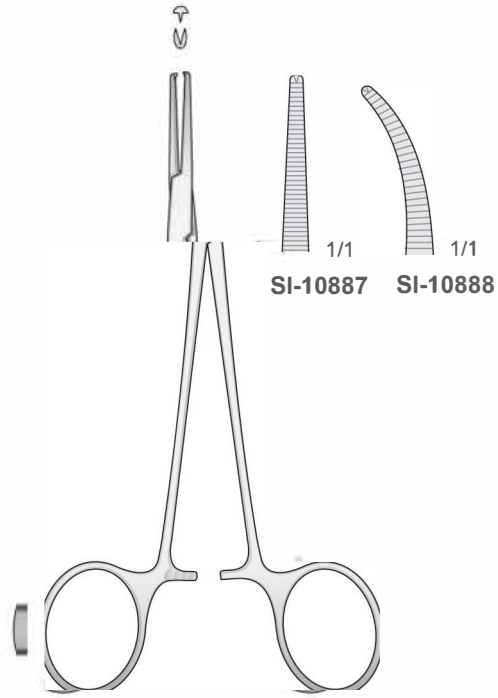

**LERICHE**  
**SI-10890**  
150 mm

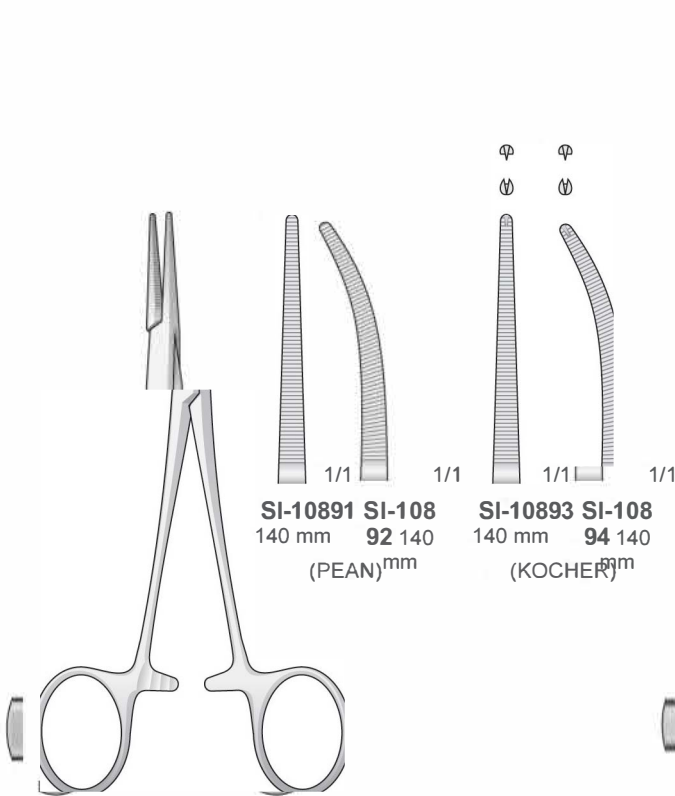

**BABY-CRILE**  
**SI-10899**  
140 mm

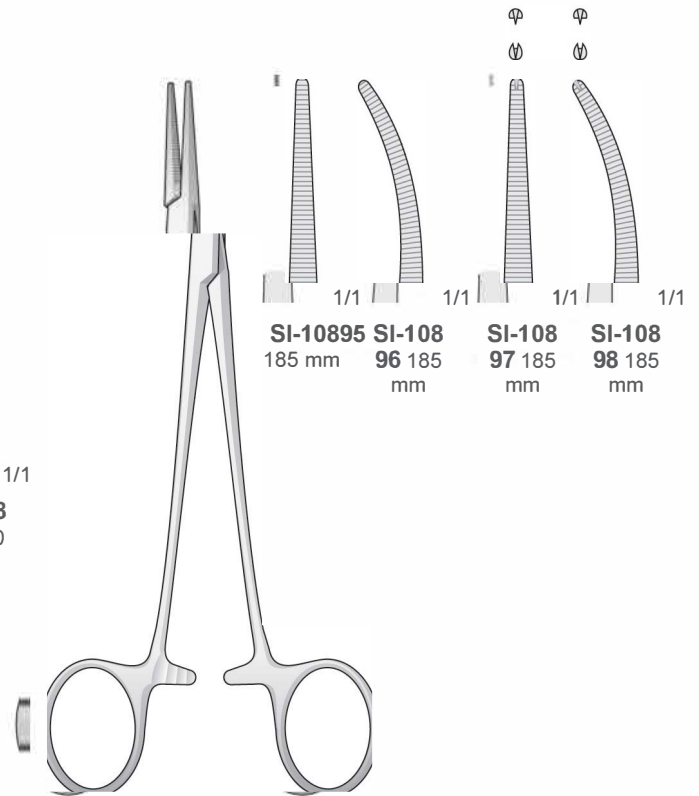

**HALSTED**  
**SI-10900**  
185 mm



wundhaken  
Retractors  
Divaricatori  
Separadores  
Écarteurs



**JOSEPH**  
**SI-10906**  
160 mm

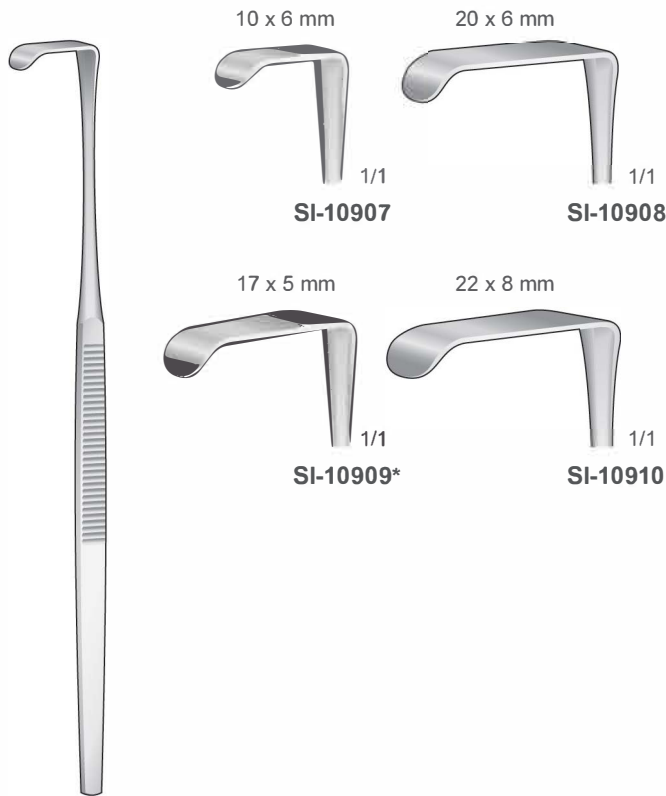
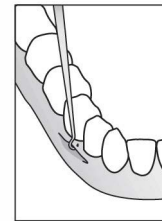
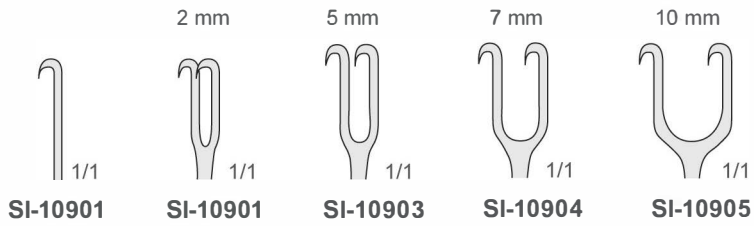

**MINI-LANGENBECK**  
**SI-10911**  
160 mm

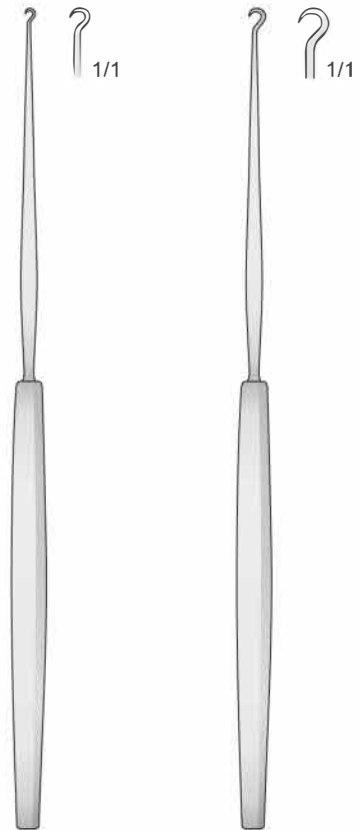

**GILLIES**  
**SI-10912**  
180 mm

**GILLIES**  
**SI-10913**  
180 mm



Wundhaken  
Retractors  
Divaricatori  
Separadores  
Écarteurs

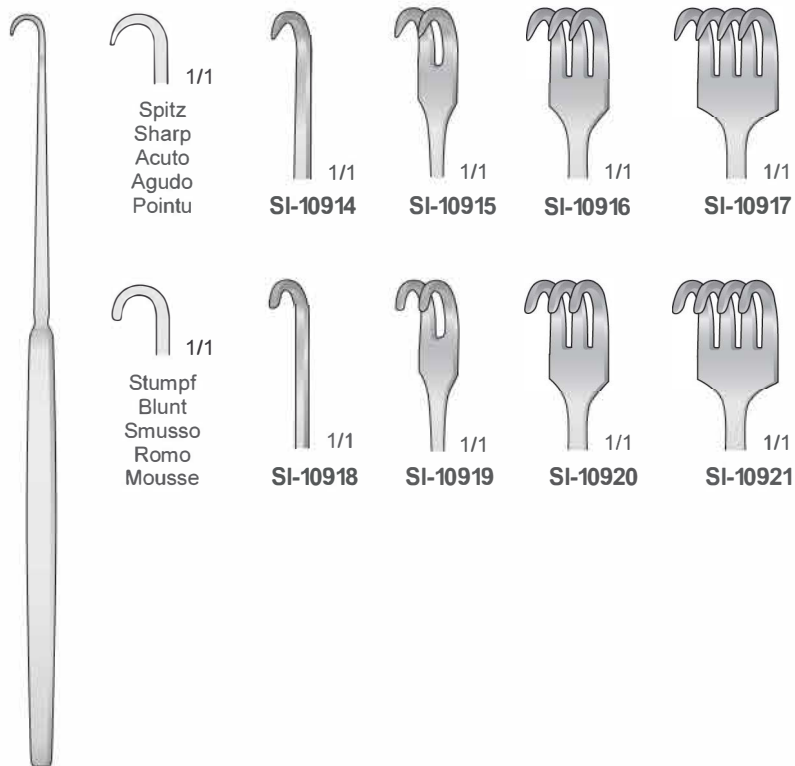

**SI-10921A**  
160 mm

Feine wundhaken flexibel-spitz  
Delicate retractors flexible-sharp  
Divaricatori delicati flessibili-acuti  
Separadores finos flexibles-agudos  
Écarteurs fins pointu flexible

Feine wundhaken flexibel-stumpf  
Delicate retractors flexible-blunt  
Divaricatori delicati flessibili-smussi  
Separadores finos flexibles-romos  
Écarteurs fins mousse flexible



**SI-10922**  
150 mm

**SI-10923**  
150 mm

**SI-10924**  
150 mm

**SI-10925**  
150 mm

**SI-10926**  
150 mm

**SI-10927**  
150 mm





wundhaken  
Retractors  
Divaricatori  
Separadores  
Écarteurs

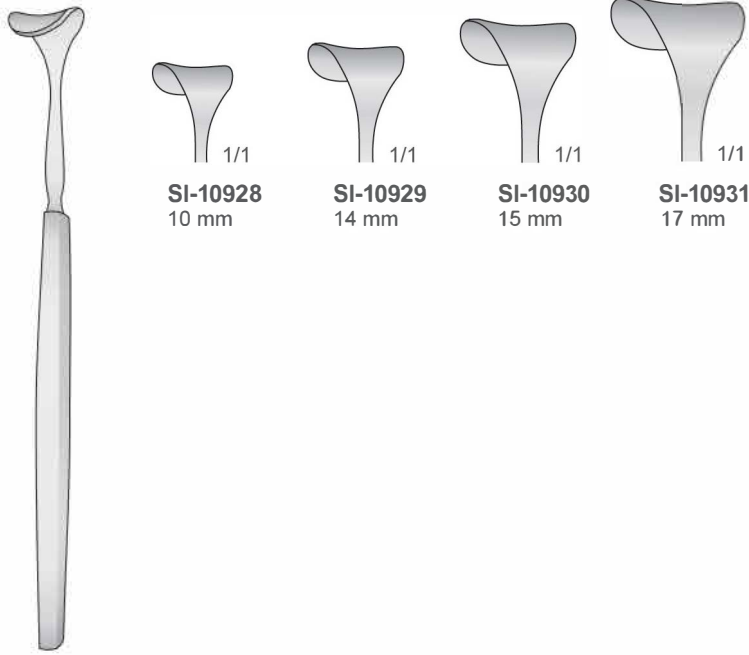

SI-10928 10 mm  
SI-10929 14 mm  
SI-10930 15 mm  
SI-10931 17 mm

**DESMARRES**  
**SI-10932**  
140 mm

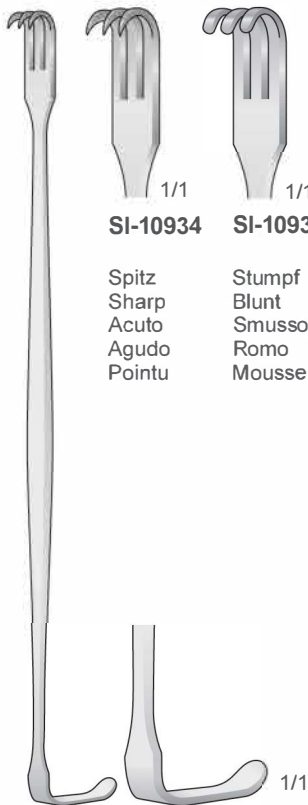

SI-10934 1/1  
SI-10935 1/1

Spitz  
Sharp  
Acuto  
Agudo  
Pointu

Stumpf  
Blunt  
Smusso  
Romo  
Mousse

**SEÁN-MILLER**  
**SI-10938**  
160 mm



SI-10936  
19 x 12 mm

SI-10937  
21 x 14 mm

**KOCHER**  
**SI-10938**  
205 mm

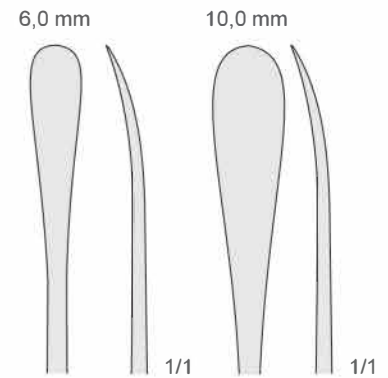

6,0 mm  
10,0 mm

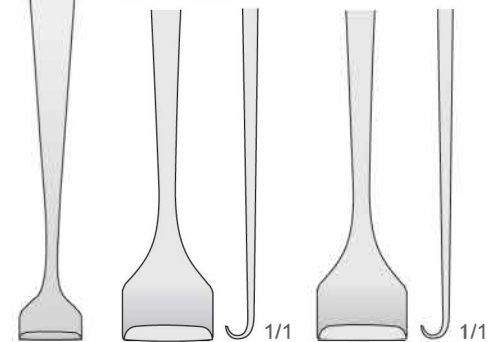

**HURD**  
**SI-10939**  
220 mm

12 mm  
12 mm



Wundhaken  
Retractors  
Divaricatori  
Separadores  
Écarteurs



**SENN GREEN**  
**SI-10942**  
160 mm

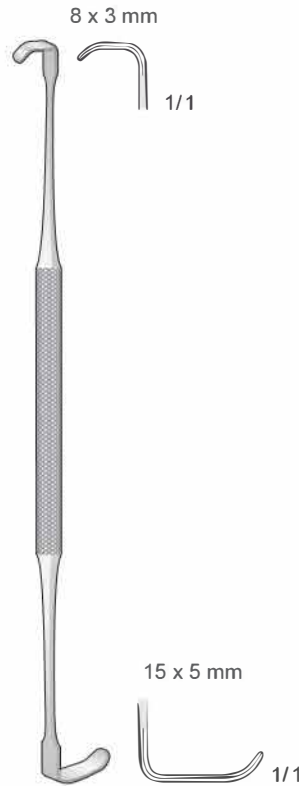

**RAGNELL**  
**SI-10943**  
140 mm

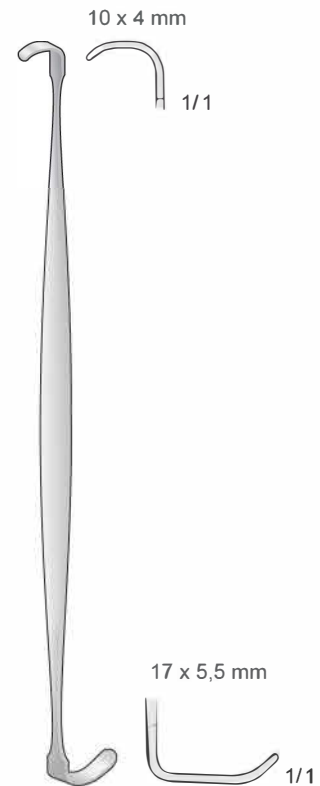

**RAGNELL-DAVIS**  
**SI-10944**  
140 mm

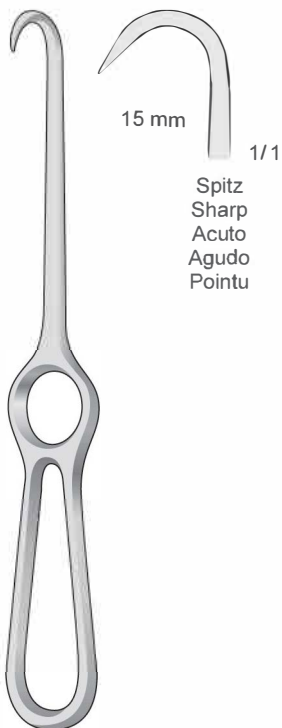

**KOCHER**  
**SI-10945**  
205 mm

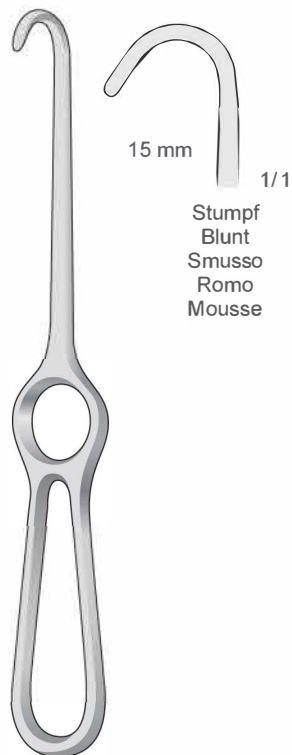

**KOCHER**  
**SI-10946**  
220 mm



**LAHEY**  
**SI-10947**  
195 mm

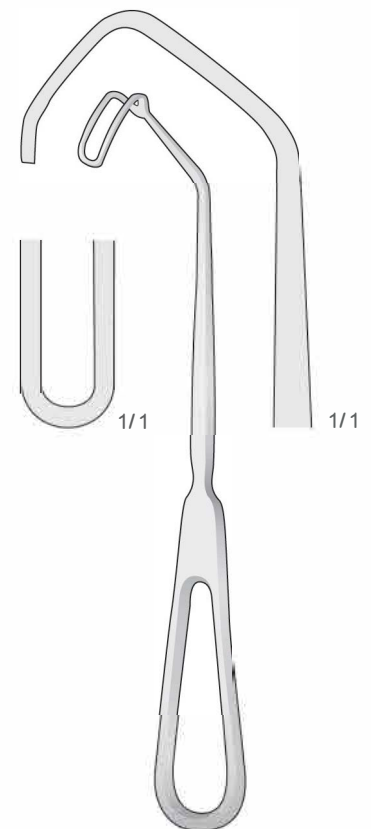

**CUSHING**  
**SI-10948**  
200 mm



wundhaken  
Retractors  
Divaricatori  
Separadores  
Écarteurs

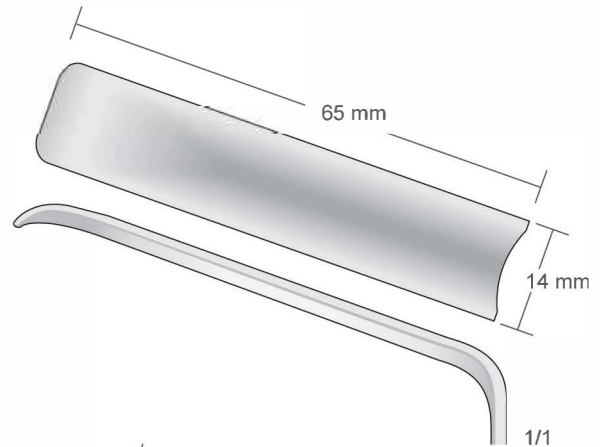

**SI-10949**

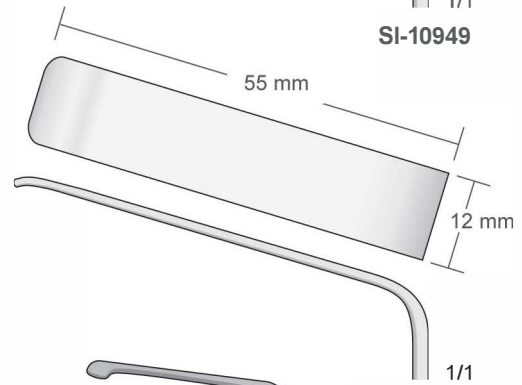

**SI-10950**

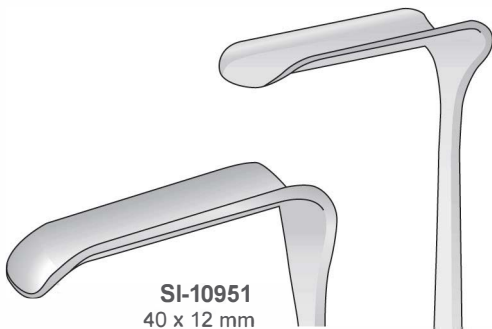

**SI-10951**  
40 x 12 mm



**SI-10952**  
55 x 14 mm



**DOCKHORN**  
**SI-10953**  
210 mm

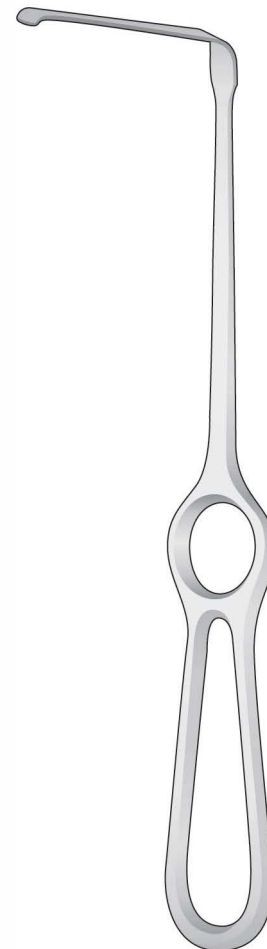

**SI-10954**  
235 mm



Wundhaken  
Retractors  
Divaricatori  
Separadores  
Écarteurs

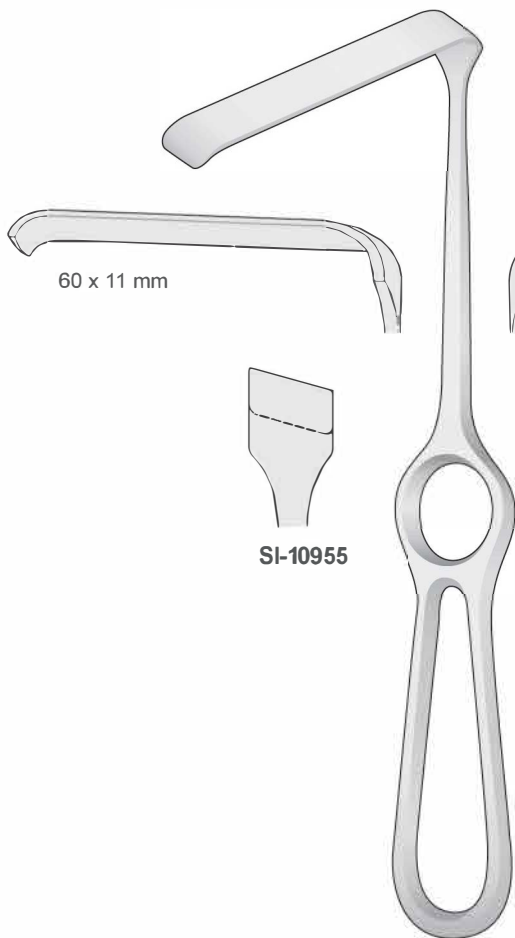

KIRSCH  
SI-10960  
210 mm

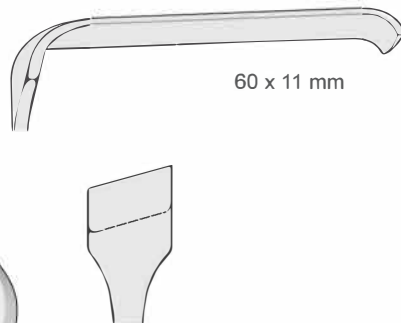

SI-10956

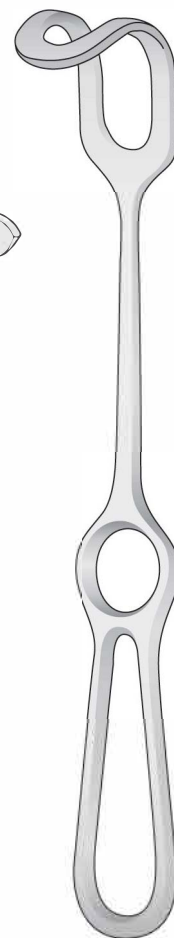

MIDDELDORPF  
SI-10961  
225 mm

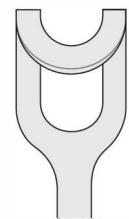

SI-10957  
15 x 15 mm

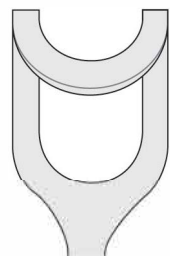

SI-10958  
20 x 22 mm

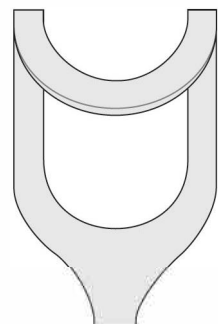

SI-10959  
28 x 28 mm



Wundhaken  
Retractors  
Divaricatori  
Separadores  
Écarteurs



OBWEGESER  
**SI-10962**  
220 mm

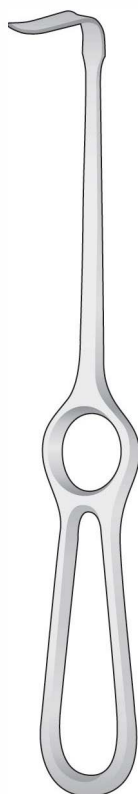

OBWEGESER  
**SI-10975**  
220 mm

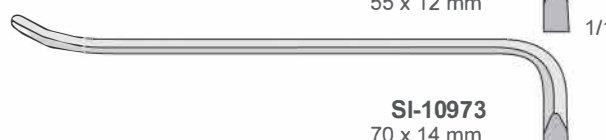
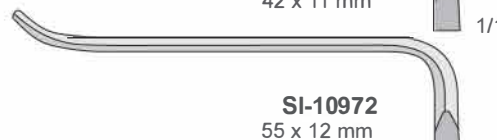
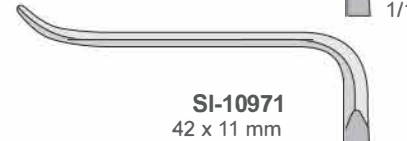
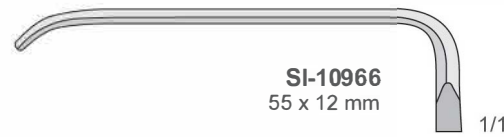
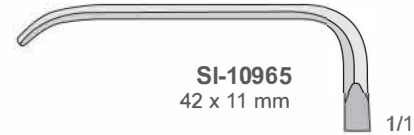







Wundhaken  
Retractors  
Divaricatori  
Separadores  
Écarteurs

Zungendrucker  
Tongue Depressors  
Abbassalingua  
Bajalengua  
Abaisse langue

Kinnhalter  
Chin Holder  
Divaricatore per mento  
Separador para mentón  
Écarteur pour menton

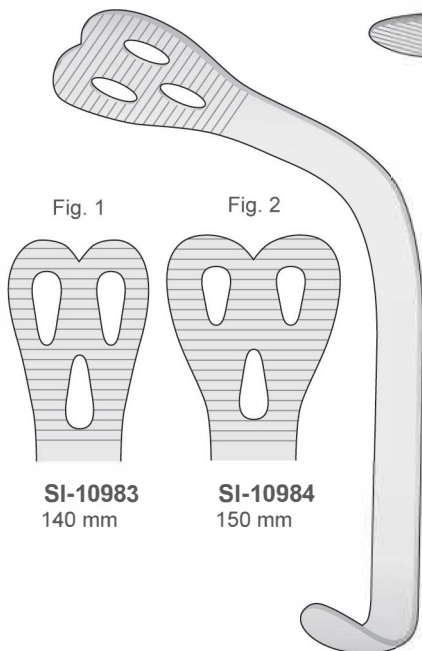
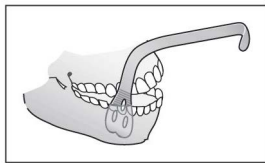
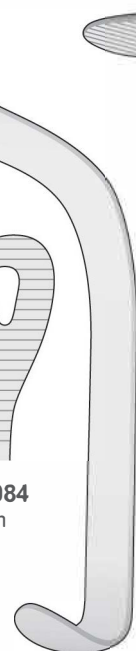

Fig. 1

Fig. 2

**SI-10983**  
140 mm

**SI-10984**  
150 mm



**WIEDER**  
**SI-10985**

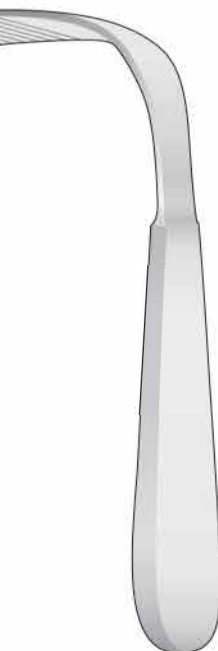

**TOBOLD**  
**SI-10986**  
145 mm

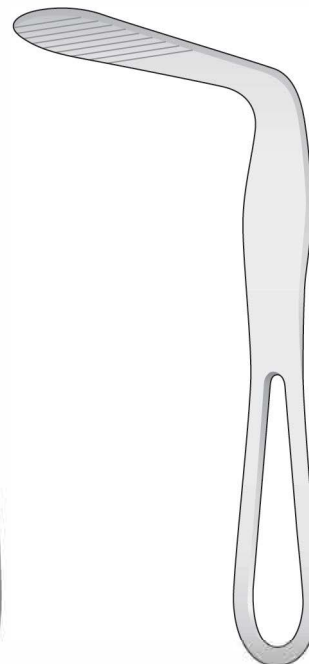

**HARTMANN**  
**SI-10987**  
150 mm

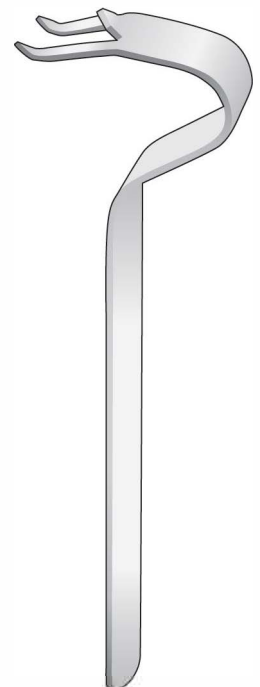

**OBWEGESER**  
**SI-10988**  
155 mm



Wundhaken  
Retractors  
Divaricatori  
Separadores  
Écarteurs

Ramushaken für Spina Nasalis  
Ramus Retractor for nasal spine  
Divaricatori per spina nasalis  
Separadores para spina nasalis  
Écarteurs pour spina nasalis

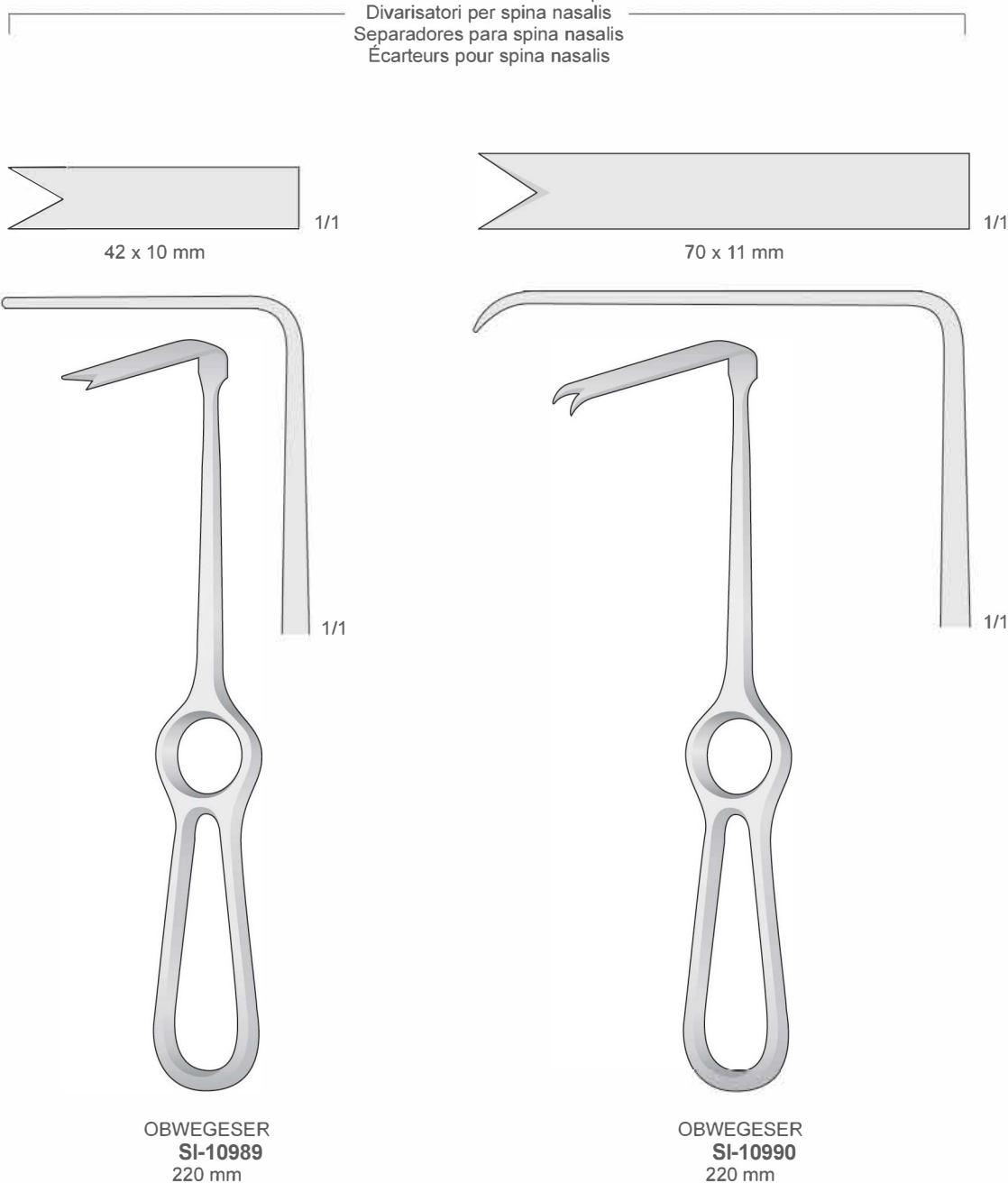



Mundsperrer  
Mouth gags  
Apribocca  
Abrebocas  
Écarteur buccal



Paar Einsätze aus Silikon für:  
Pair of silicone inserts for: Coppia  
di inserti in silicone per: Pareja de  
inserto de silicone para: Paire de  
inserts en silicon pour:

Ø 8 mm



**SI-10991**  
30 mm

Ø 11 mm



**SI-10992**  
30 mm

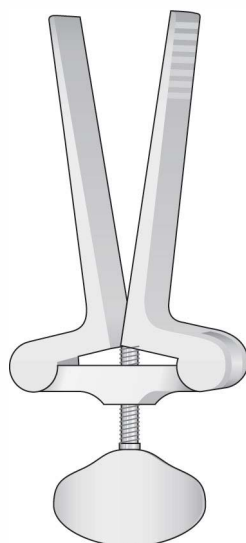

**HEISTER**  
**SI-10993**  
135 mm

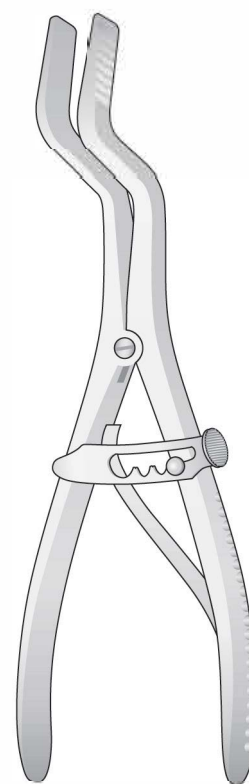

**ROSER KÖNIG**  
**SI-109094**  
185 mm

Für Erwachsene - For adults  
Per adulti - Para adultos  
Pour adultes

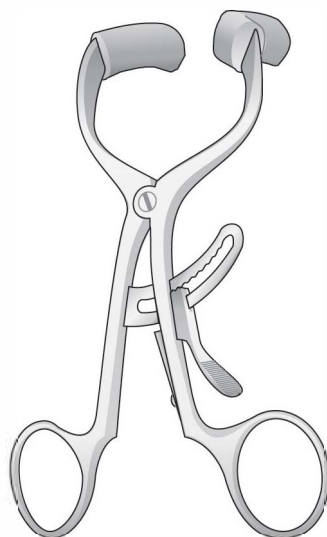

**MOLT**  
**DOYEN-JANSEN**  
**SI-10995**  
140 mm

Für Erwachsene - For adults  
Per adulti - Para adultos  
Pour adultes

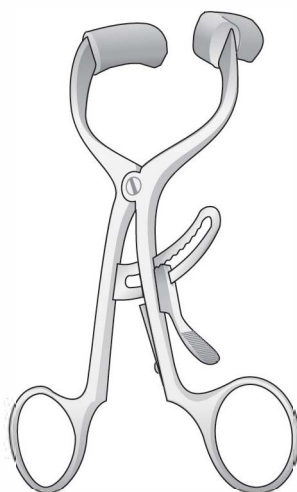

**MOLT**  
**DOYEN-COLLIN**  
**SI-1096**  
120 mm

Für Kinder  
For children  
Per bambini  
Para niños  
Pour enfants

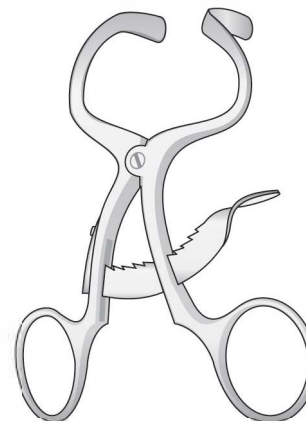

**MOLT**  
**SI-10997**  
100 mm



Mundsperrer  
Mouth gags  
Apribocca  
Abrebocas  
Écarteur buccal

Abhalter für gesamten Ober-bzw. Unterkiefer  
Retractor for complete upper resp. Lower jaws  
Retratore per arcata superiore e inferiore intera  
Separadores para quijadas enteras inferiores y superiores  
Écarteurs pour machoires complètes inférieures et supérieures

- OM-74** Fig. 0 100 x 95 mm
- OM-75** Fig. 1 115 x 105 mm
- OM-76** Fig. 2 115 x 110 mm
- OM-77** Fig. 3 125 x 115 mm

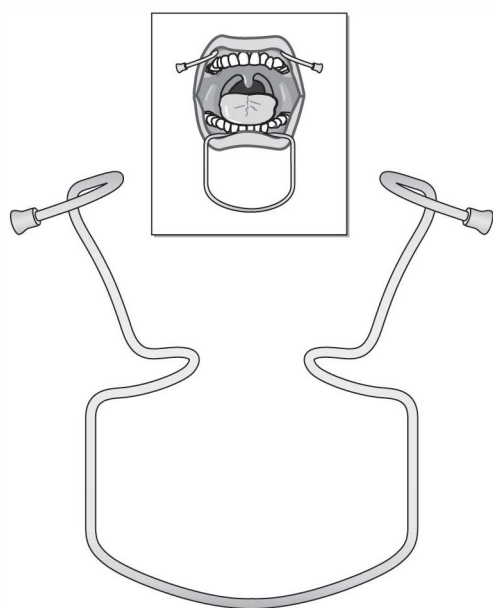

**ORINGER**  
**SI-10998**

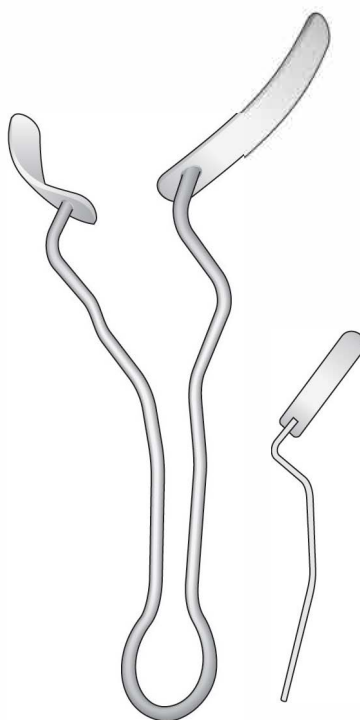

**MATY**  
**SI-10999**  
170 mm

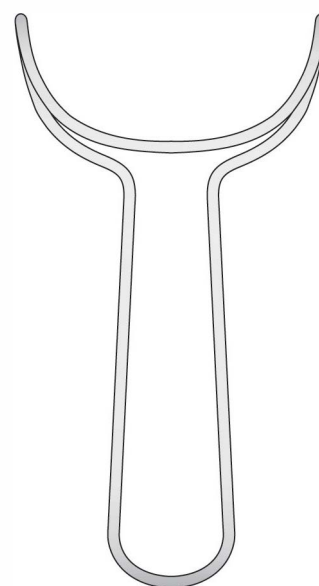

**SI-11001**  
150 mm



Wundhaken  
Retractors  
Divaricatori  
Separadores  
Écarteurs

**SI-11006**  
Set completo  
Set complete  
Komplettsset  
Set complet  
Set completo  
**BT-284 + BT-285 + BT-286**

29 mm  
26 mm  
22 mm

28 mm  
38 mm  
44 mm

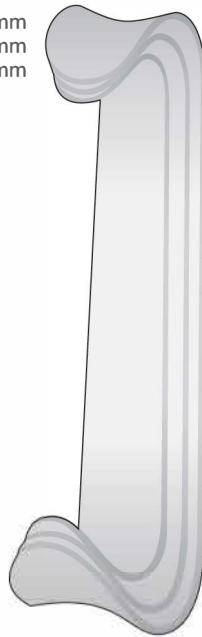

**ROUX  
SI-11002**  
165 mm



**ROUX  
SI-11003**  
20x22 mm  
25x28 mm



**ROUX  
SI-11004**  
23x26 mm  
29x38 mm



**ROUX  
SI-11005**  
29x29 mm  
34x44 mm

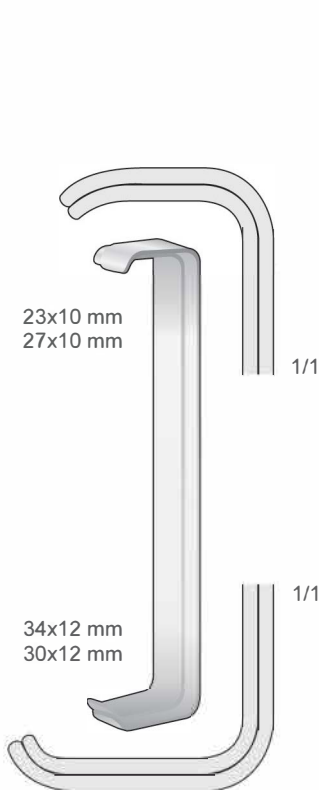

23x10 mm  
27x10 mm

1/1

34x12 mm  
30x12 mm

1/1

**FARABEUF  
SI-11007**  
120 mm

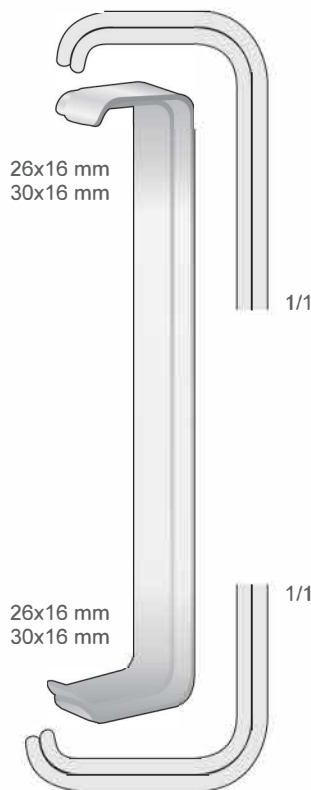

26x16 mm  
30x16 mm

1/1

26x16 mm  
30x16 mm

1/1

**FARABEUF  
SI-11008**  
150 mm

20x22 mm

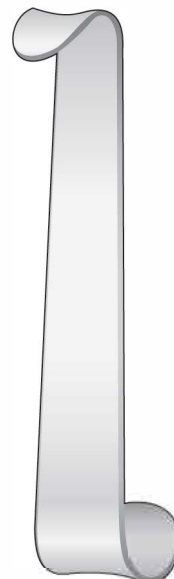

**ROUX-MAGNUS  
SI-11009**  
150 mm

23x26 mm



**ROUX-MAGNUS  
SI-11010**  
160 mm

29x29 mm

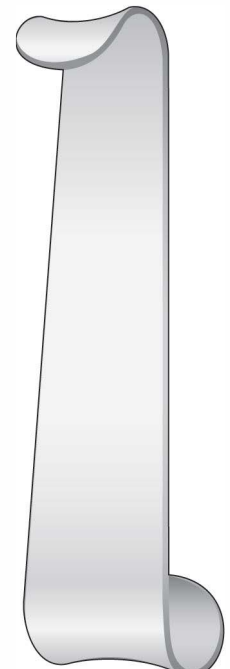

**ROUX-MAGNUS  
SI-11011**  
170 mm



Wundhaken  
Retractors  
Divaricatori  
Separadores  
Écarteurs

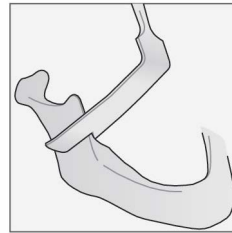

Ramus Retraktoren Recht  
Ramus Retractor Right  
Retrattore Ramus destro  
Separadores Ramus derecho  
Écarteur Ramus droites

Ramus Retraktoren Link  
Ramus Retractor Left  
Retrattore Ramus sinistro  
Separadores Ramus izquierdo  
Écarteur Ramus gauches

8 mm

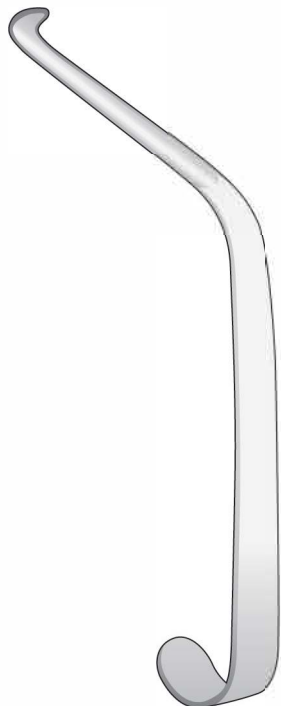

OBWEGESER  
**SI-11012**  
165 mm

10 mm

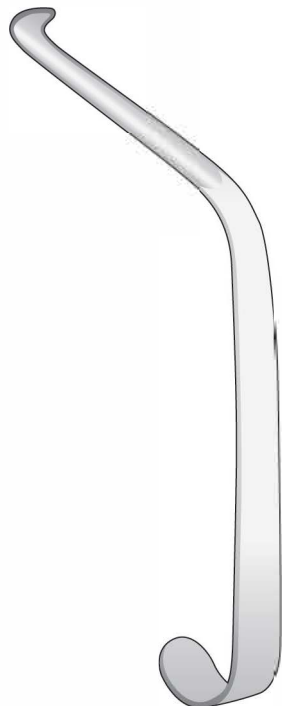

OBWEGESER  
**SI-11013**  
165 mm



MISCH  
**SI-11014**  
210 mm



MISCH  
**SI-11015**  
210 mm





Mundsperrer  
Mouth Gags  
Apribocca  
Abrebocas  
Écarteur buccal

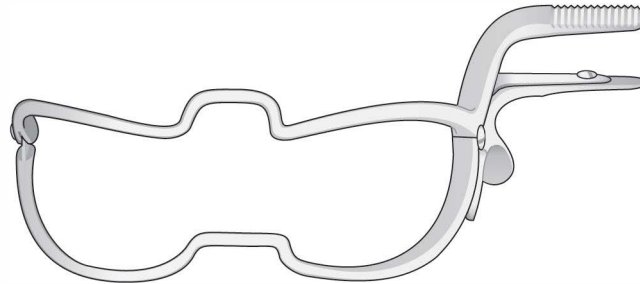

**WHITEHEAD-JENNINGS**  
**SI-11016** 90 mm **SI-11017**  
110 mm **SI-11018** 130 mm  
**SI-11019** 150 mm

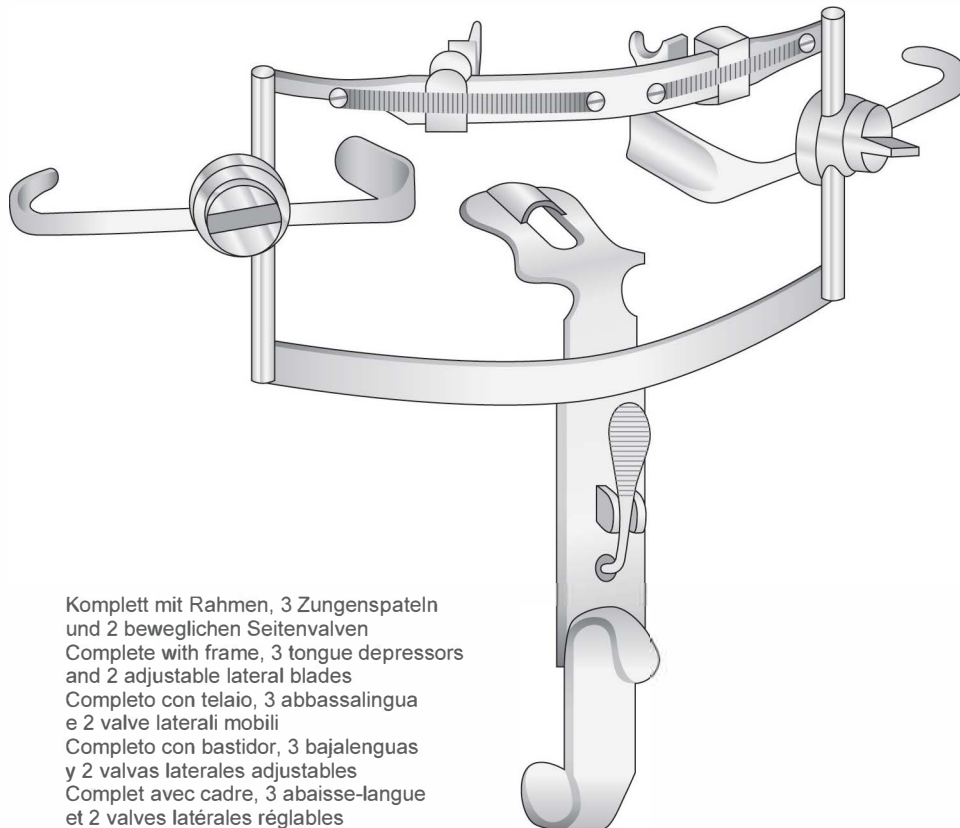

Komplett mit Rahmen, 3 Zungenspateln  
und 2 beweglichen Seitenvälven  
Complete with frame, 3 tongue depressors  
and 2 adjustable lateral blades  
Completo con telaio, 3 abbassalingua  
e 2 valve laterali mobili  
Completo con bastidor, 3 bajalenguas  
y 2 valvas laterales ajustables  
Complet avec cadre, 3 abaisse-langue  
et 2 valves latérales réglables

**DINGMANN**  
**SI-11023**  
Set completo

**DINGMANN**

Zungenspatel  
Tongue depressor  
Abbassalingua  
Bajalengua  
Abaisse langue

Fig. 1

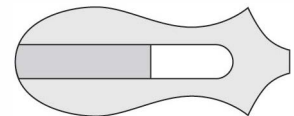

**SI-11020**  
65 x 25 mm

Fig. 2

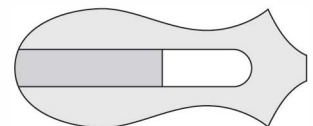

**SI-11021**  
70 x 29 mm

Fig. 3

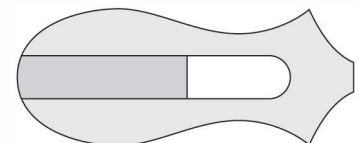

**SI-11022**  
80 x 32 mm



Wundhaken  
Retractors  
Divaricatori  
Separadores  
Écarteurs

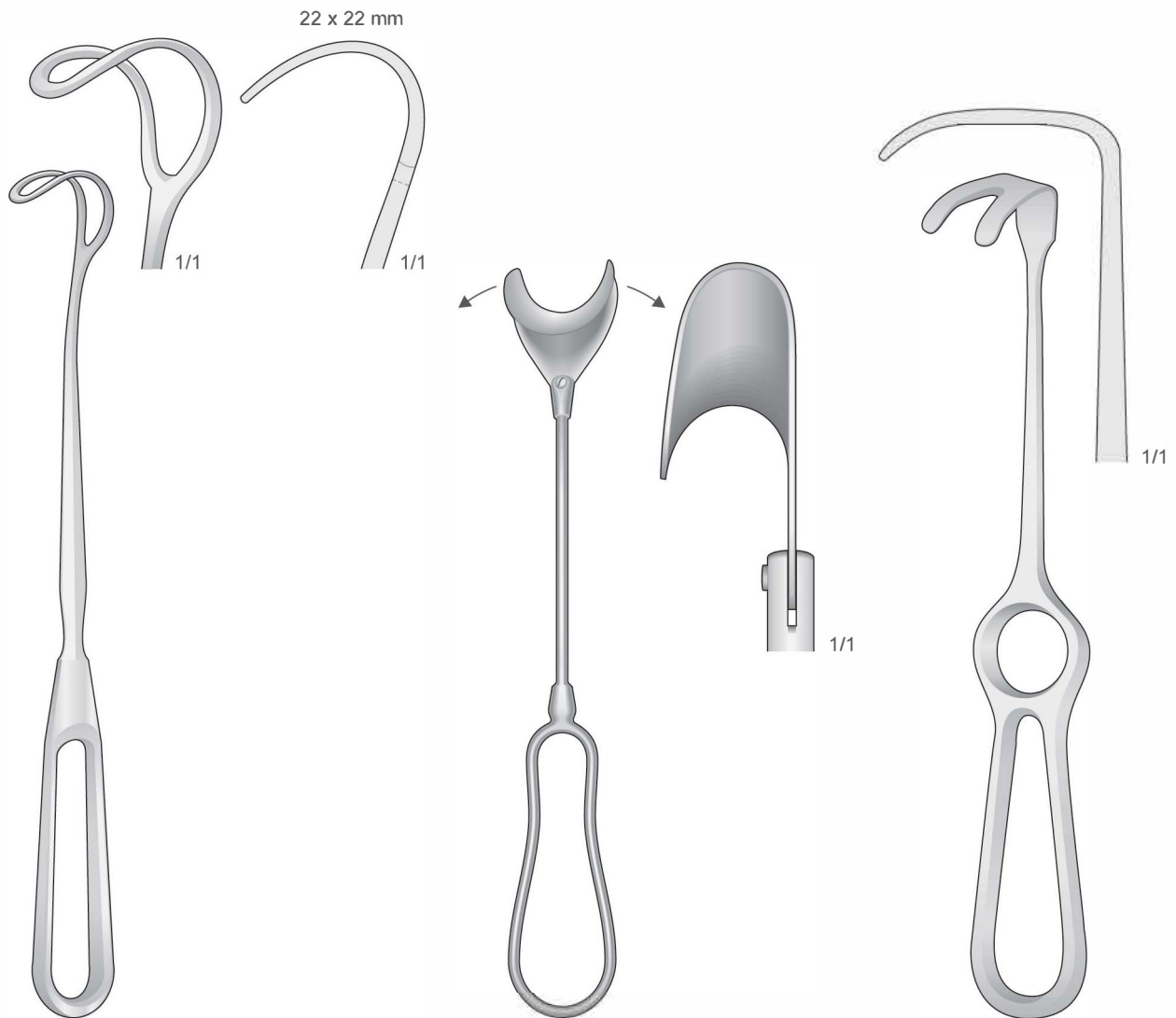

**GREENE**  
**SI-11024**  
225 mm

**SI-11025**  
200 mm

**WASSMUND**  
**SI-11026**  
220 mm



Zungenspatel - Zungenzangen  
Tongue Depressors - Tongue Holding Forceps  
Abbassalingua - Pinze tiralingua  
Bajalenguas - Pinzas tira-lengua  
Abaisse langues - Pincés tire-langue

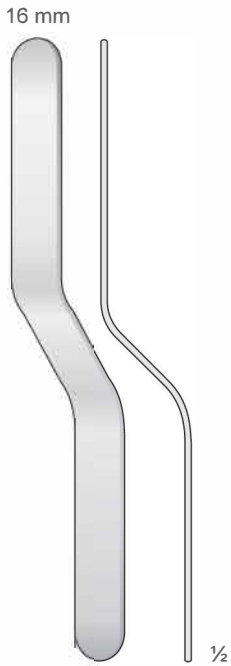

**SI-11027**  
145 mm

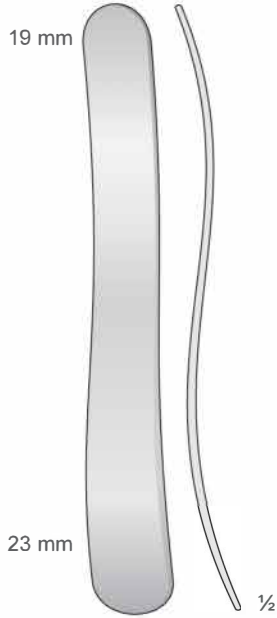

**KROENIG**  
**SI-11028**  
150 mm

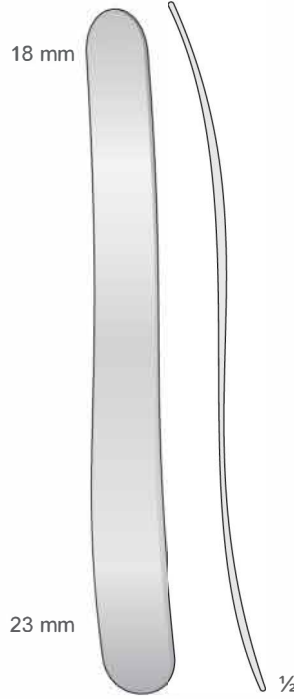

**BUCHWALD**  
**SI-11029**  
180 mm

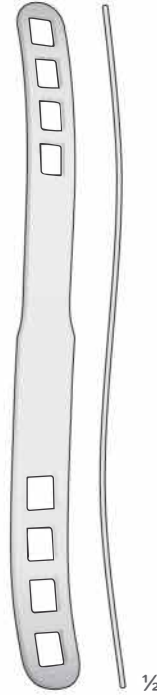

**BRUENINGS**  
**SI-11030**  
190 mm

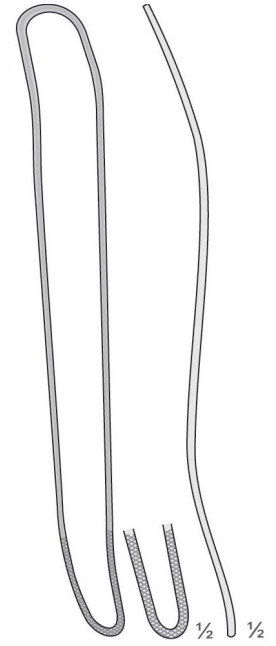

**FRENZEL**  
**SI-11031**  
165 mm

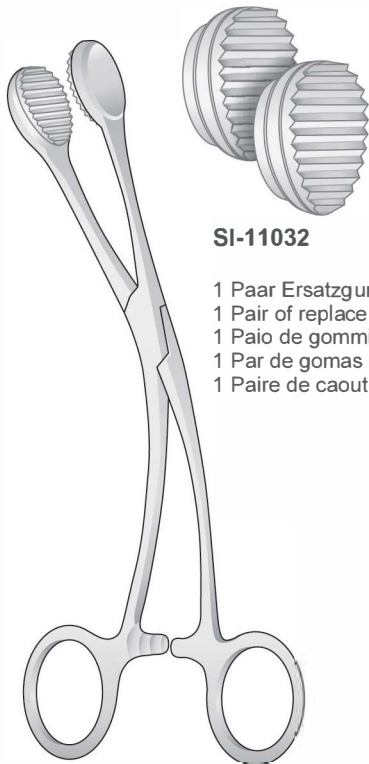

**YOUNG**  
**SI-11035**  
160 mm

**SI-11032**

- 1 Paar Ersatzgummi
- 1 Pair of replacement rubber pads
- 1 Paio de gommini di ricambio
- 1 Par de gomas de recambio
- 1 Paire de caoutchouc de rechange

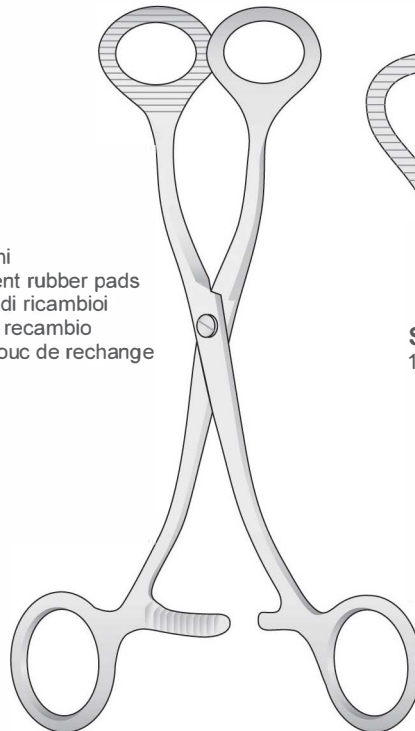

**COLLIN**  
**SI-11036**

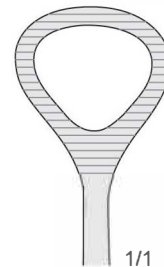

1/1  
**SI-11033**  
165 mm

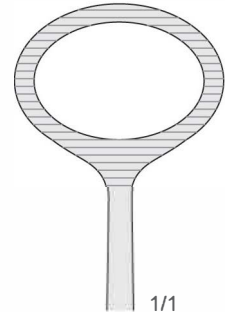

1/1  
**SI-11034**  
170 mm



Osteotome - Meißel  
 Osteotomes - Gouges  
 Osteotomi - Sgorbie  
 Osteótomos - Gubias  
 Osteótomes - Gouges

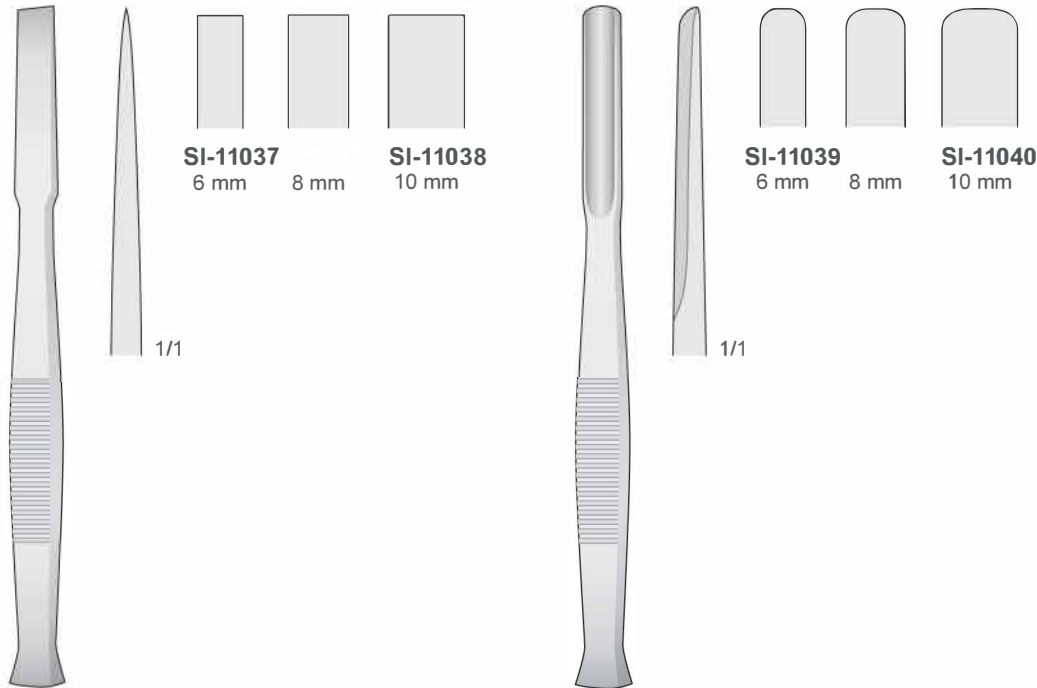

**SI-11037**  
6 mm    8 mm    10 mm

**SI-11039**    **SI-11040**  
6 mm    8 mm    10 mm

**SI-11041**  
140 mm

**SI-11042**  
140 mm

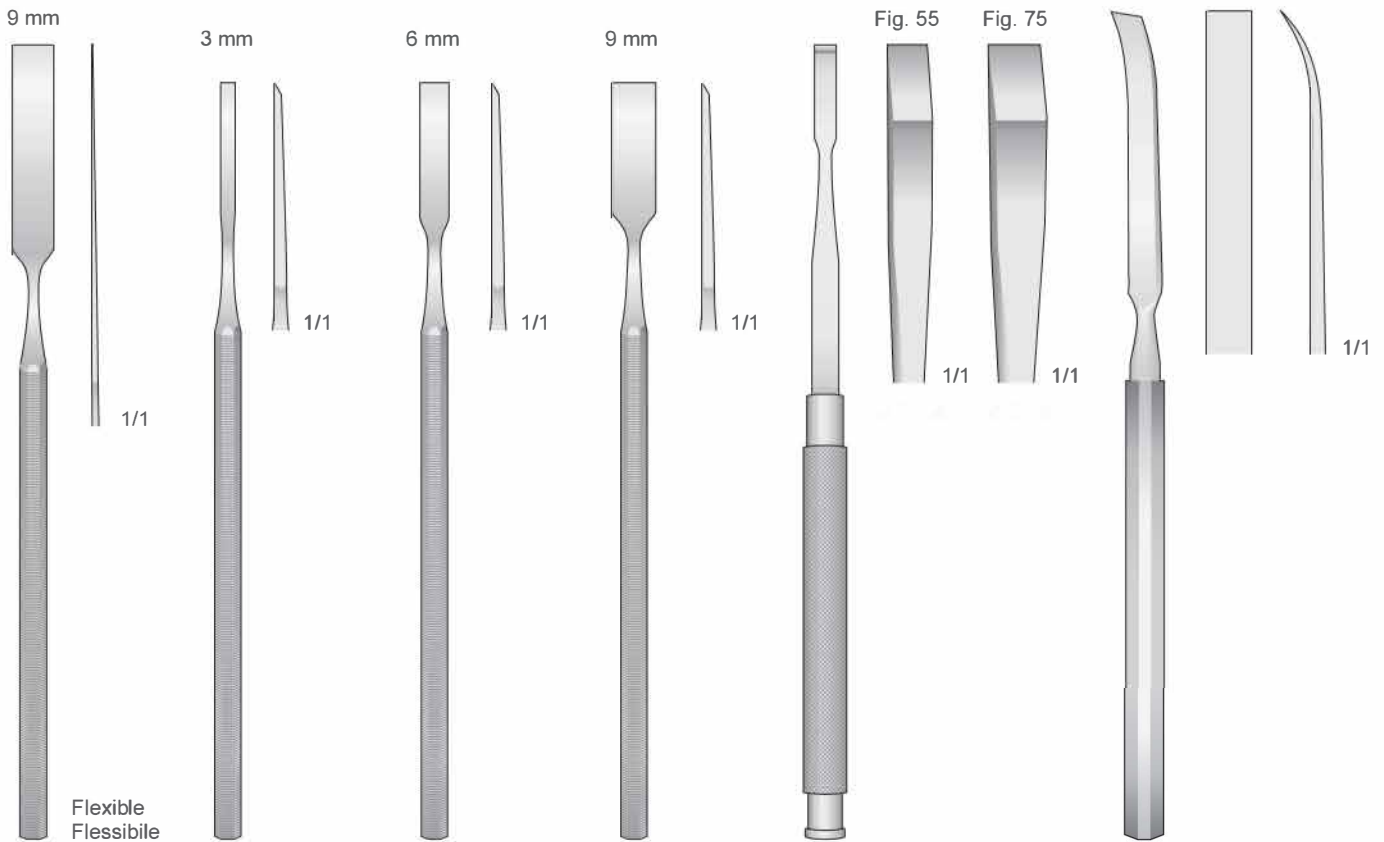

**SI-11043**  
170 mm

**SI-11044**  
155 mm

**SI-11045**  
155 mm

**SI-11046**  
155 mm

**KRAMER-NEVINS**  
**SI-11047**  
175 mm

**SI-11048**  
180 mm



Osteotome - Hohlmeissel  
 Osteotomes - Gouges  
 Osteotomi - Scalpelli  
 Osteótomos - Cinceles  
 Ostéotomes - Scalpel

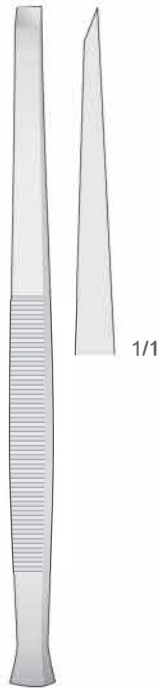

**PARTSCH**  
**SI-11055**  
 140 mm



**SI-11049**  
 3 mm



**SI-11051**  
 4 mm



**SI-11053**  
 5 mm

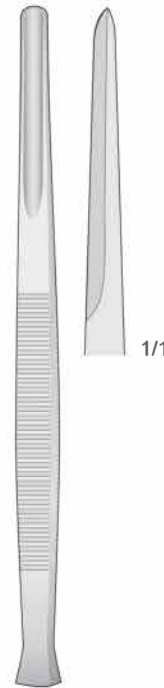

**PARTSCH**  
**SI-11056**  
 140 mm



**SI-11050**  
 3 mm



**SI-11052**  
 4 mm



**SI-11054**  
 5 mm

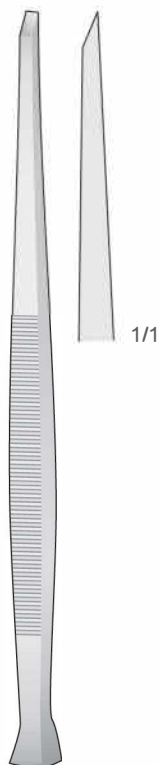

**PARTSCH**  
**SI-11067**  
 170 mm



**SI-11057**  
 3 mm



**SI-11058**  
 6 mm



**SI-11061**  
 4 mm



**SI-11062**  
 7 mm



**SI-11065**  
 5 mm

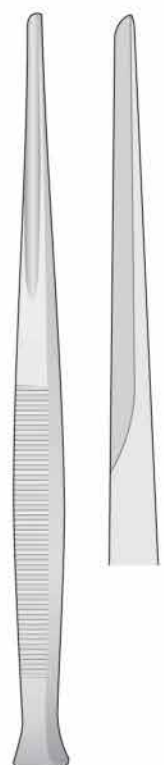

**PARTSCH**  
**SI-11068**  
 170 mm



**SI-11059**  
 3 mm



**SI-11060**  
 6 mm



**SI-11063**  
 4 mm



**SI-11064**  
 7 mm



**SI-11066**  
 5 mm



Osteotome - Meissel  
 Osteotomes - Chisels  
 Osteotomi - Scalpelli  
 Osteótomos - Cinceles  
 Ostéotomes - Burins

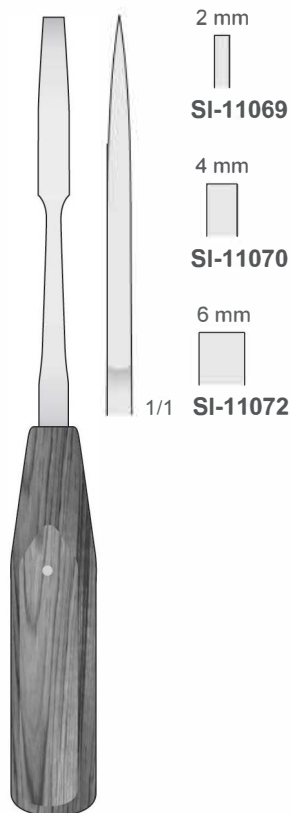

**MINI-LEXER**  
**SI-11074**  
 200 mm

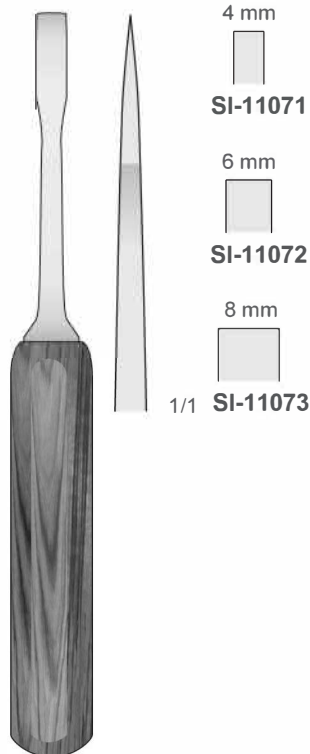

**MINI-LEXER**  
**SI-110754**  
 180 mm

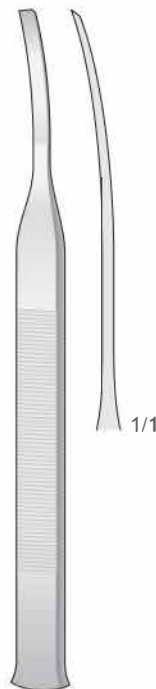

**TESSIER**  
 SI-11076  
 SI-11077  
 160 mm

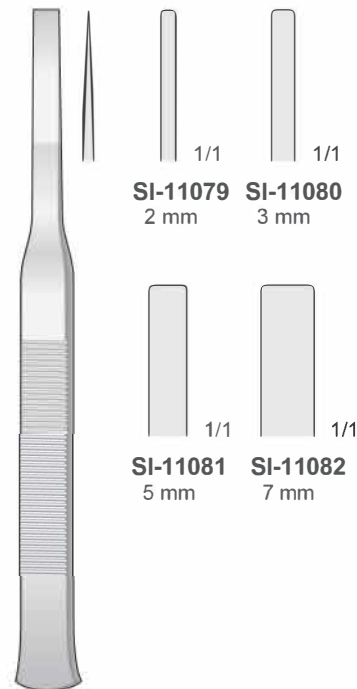

**TESSIER**  
**SI-11078**  
 160 mm

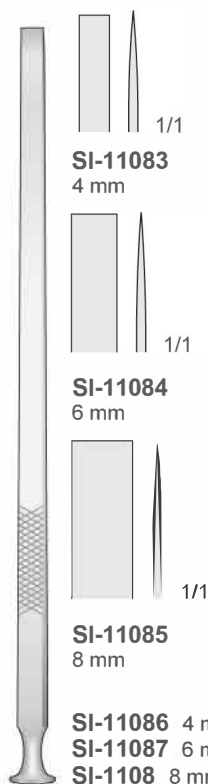

**EPKER**  
**SI-11100**  
 180 mm

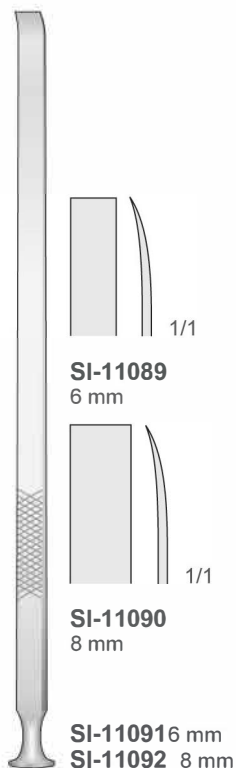

**EPKER**  
**SI-11101**  
 180 mm

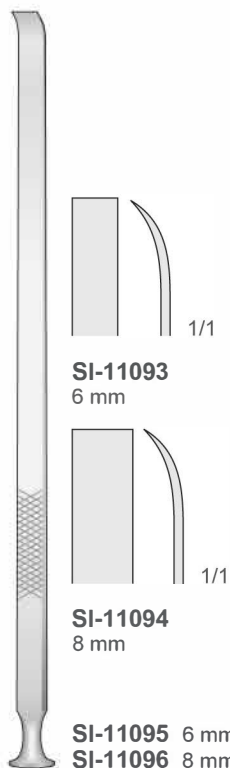

**EPKER**  
**SI-11102**  
 180 mm

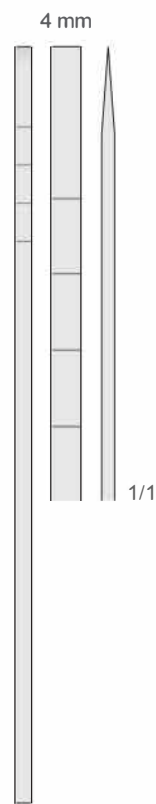

**COTTLE**  
**SI-11097**  
 180 mm

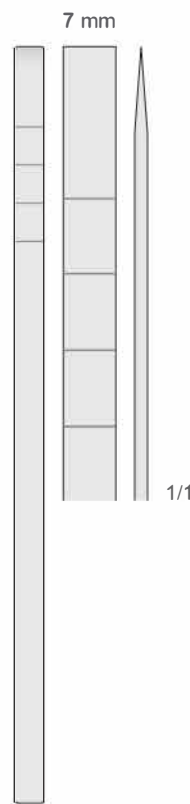

**COTTLE**  
**SI-11098**  
 180 mm

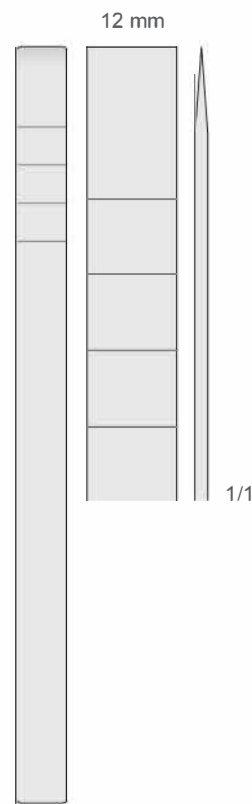

**COTTLE**  
**SI-11099**  
 180 mm





Osteotome  
Osteotomes  
Osteotomi  
Osteótomos  
Ostéotomes

# 1	Diam.	# 2	Diam.	# 3	Diam.	# 4	Diam.	# 5	Diam.
0	Ø 1.50	0	Ø 2.10	0	Ø 2.60	0	Ø 3.00	0	Ø 3.50
5	Ø 1.90	5	Ø 2.60	5	Ø 3.00	5	Ø 3.50	5	Ø 3.90
8	Ø 2.20	8	Ø 2.80	8	Ø 3.30	8	Ø 3.80	8	Ø 4.20
10	Ø 2.40	10	Ø 3.00	10	Ø 3.50	10	Ø 4.00	10	Ø 4.40
12	Ø 2.60	12	Ø 3.20	12	Ø 3.70	12	Ø 4.20	12	Ø 4.60
14	Ø 2.80	14	Ø 3.40	14	Ø 3.90	14	Ø 4.40	14	Ø 4.80

Straight  
Gerade  
Droit  
Recto  
Diritto

Bone Pusher

# 1 Ø 1.5 mm    # 2 Ø 2.1 mm    # 3 Ø 2.6 mm    # 4 Ø 3.0 mm    # 5 Ø 3.5 mm    Ø 2.8 mm    Ø 3.5 mm    Ø 4.2 mm

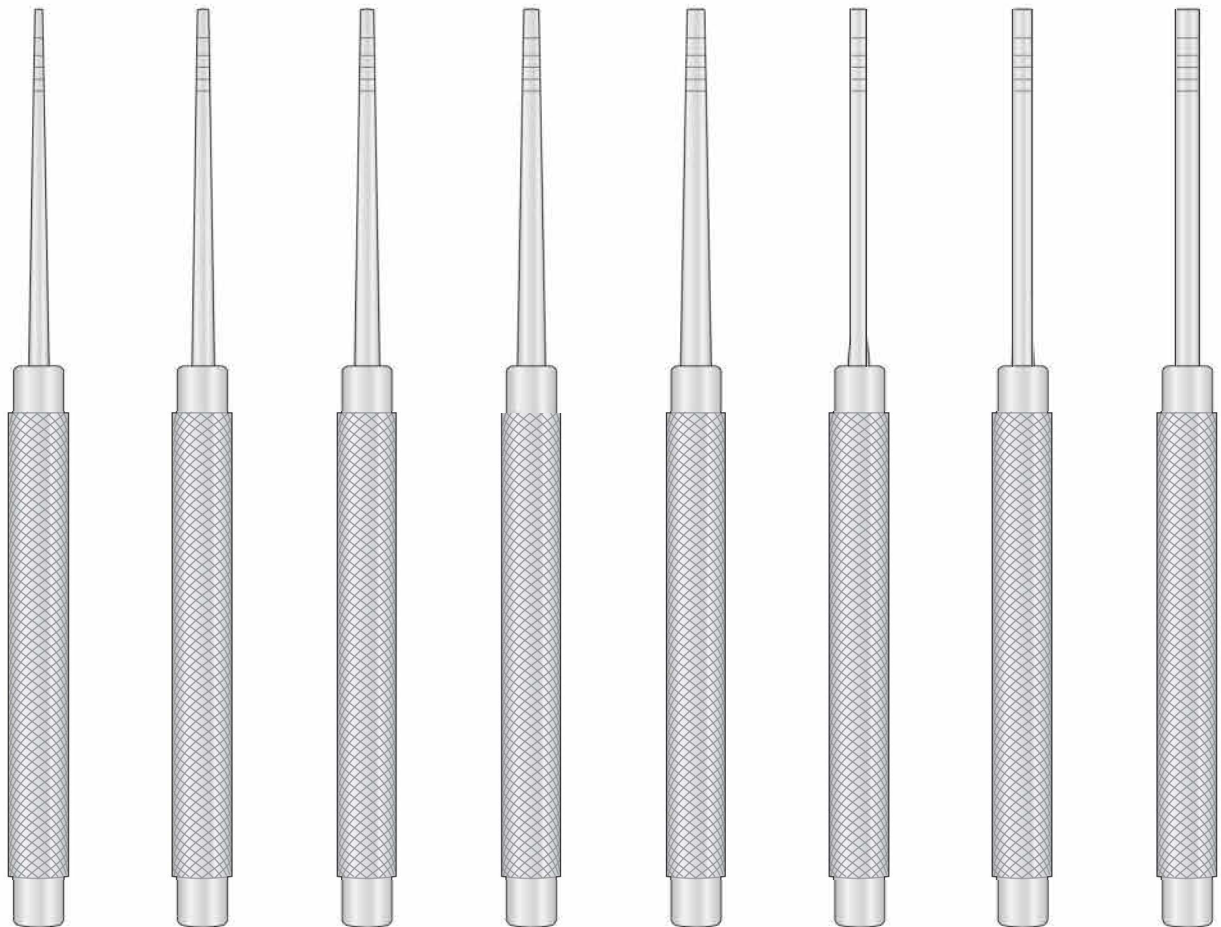

SI-11103 55 mm    SI-11104 155 mm    SI-11105 155 mm    SI-11106 155 mm    SI-11107 155 mm    SI-11108 155 mm    SI-11109 155 mm    SI-11110 155 mm



Osteotome  
Osteotomes  
Osteotomi  
Osteótomos  
Ostéotomes

Meißeln Graduiert  
Graduated Chisels  
Scalpelli graduati  
Cinceles graduados  
Burins gradués

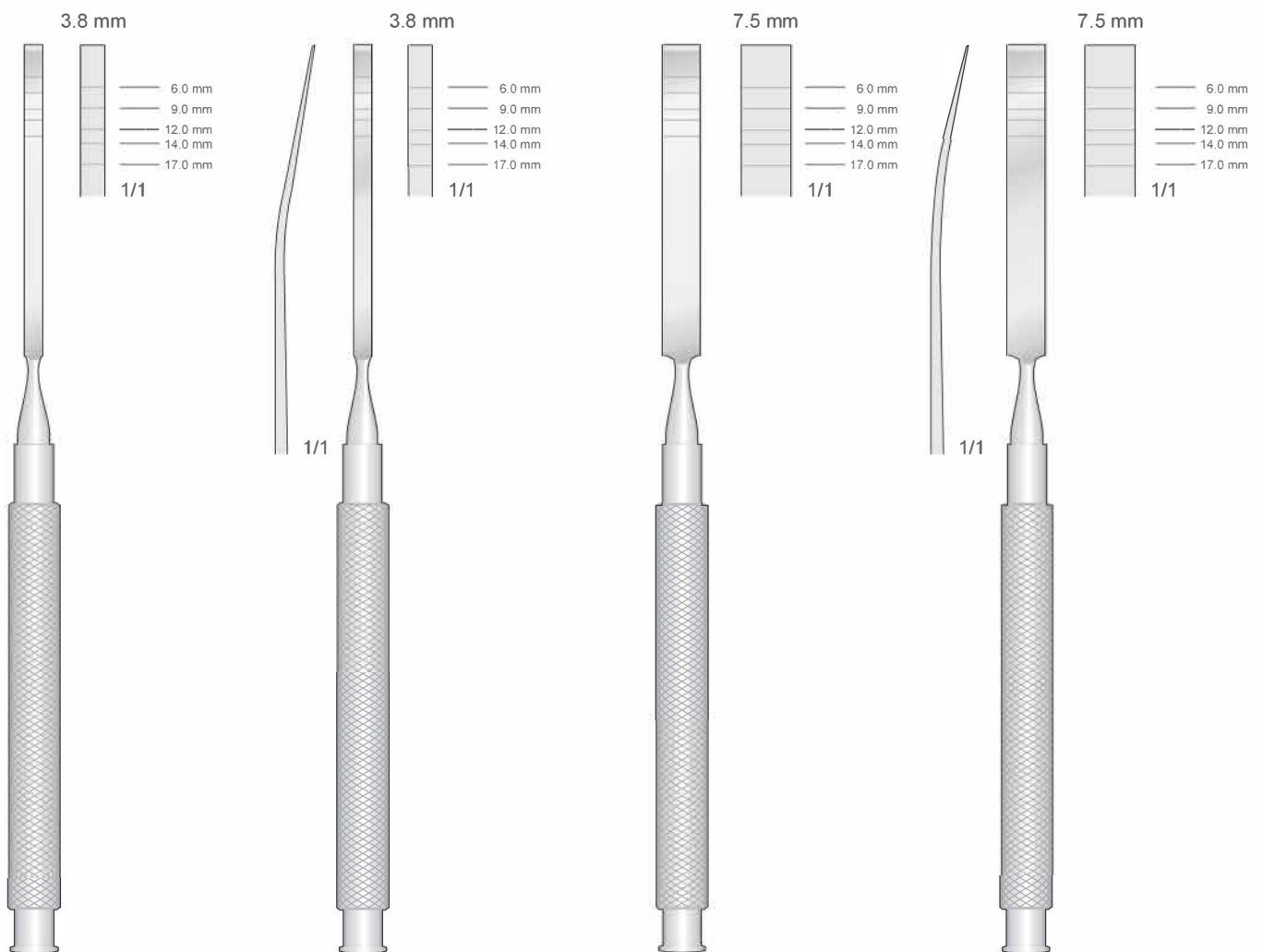

SI-11111  
170 mm

SI-11112  
170 mm

SI-11113  
170 mm

SI-11114  
170 mm



## Osteotome

Osteotomes  
Osteotomi  
Osteótomos  
Ostéotomes

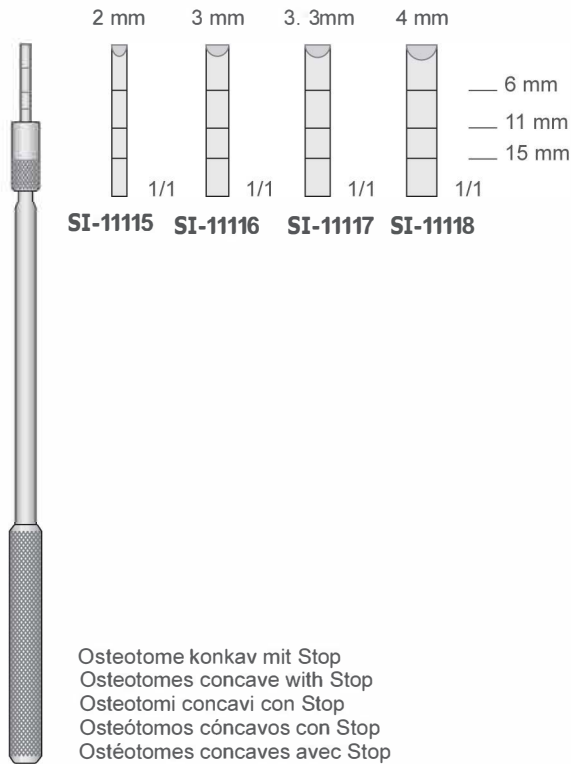

**SI-11123**  
165 mm

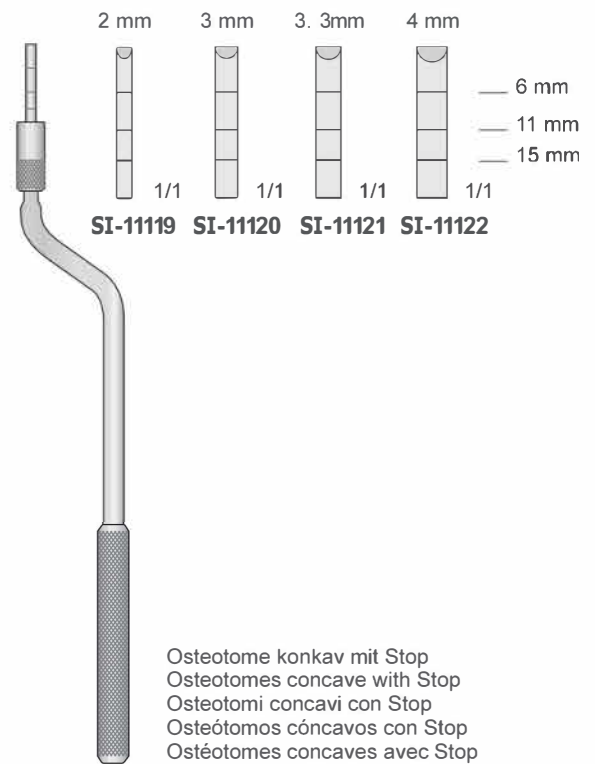

**SI-11124**  
165 mm

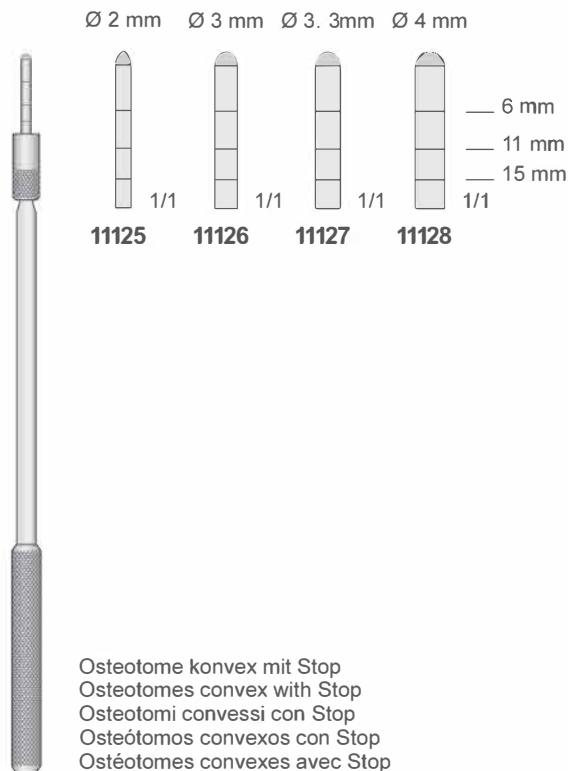

**SI-11133**  
165 mm

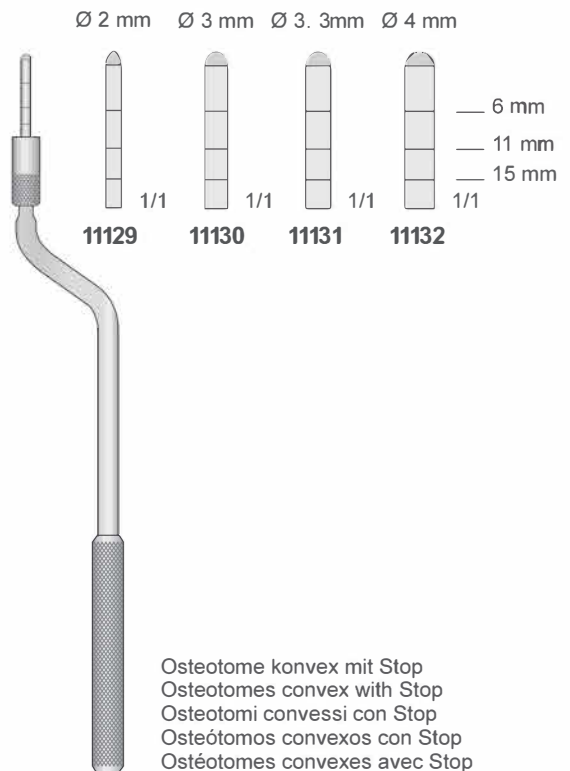

**SI-11134**  
160 mm



Osteotome  
Osteotomes  
Osteotomi  
Osteótomos  
Ostéotomes

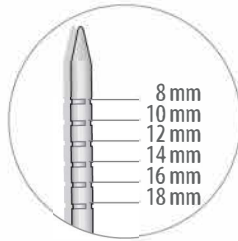

Dilatator  
Dilator  
Dilatatori  
Dilatador  
Dilatateur

**A-Form**

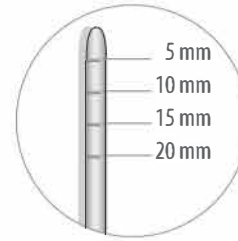

Spreader  
Spreader  
Expansori  
Expansor  
Expandeur

**D-Form  
Convex Tip**

Ø 2 mm



**SI-11135**  
145 mm

Ø 3 mm



**SI-11136**  
145 mm

Ø 3.3 mm



**SI-11137**  
145 mm

Ø 4 mm



**SI-11138**  
145 mm

Ø 3 mm



**SI-11139**  
145 mm

Ø 4 mm



**SI-11140**  
145 mm

Ø 5 mm



**SI-11141**  
145 mm



Raspatorien - Elevatorien  
 Raspatories - Elevators  
 Periostotomi - Elevatori  
 Legras - Elevadores  
 Rugines - Elevateurs

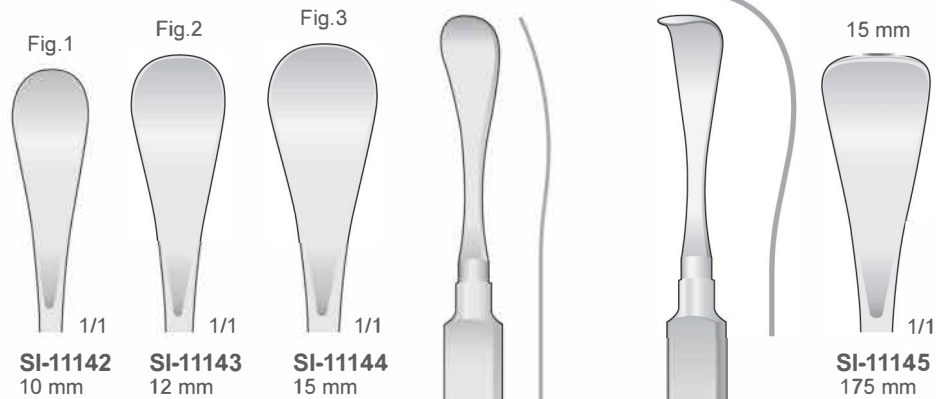

Halbscharf  
 Semi-Scharp  
 Semitagliente  
 Semicortante  
 Semitranchant

HENAHAN  
**SI-11146**  
 175 mm

HENAHAN  
**SI-11147**  
 175 mm

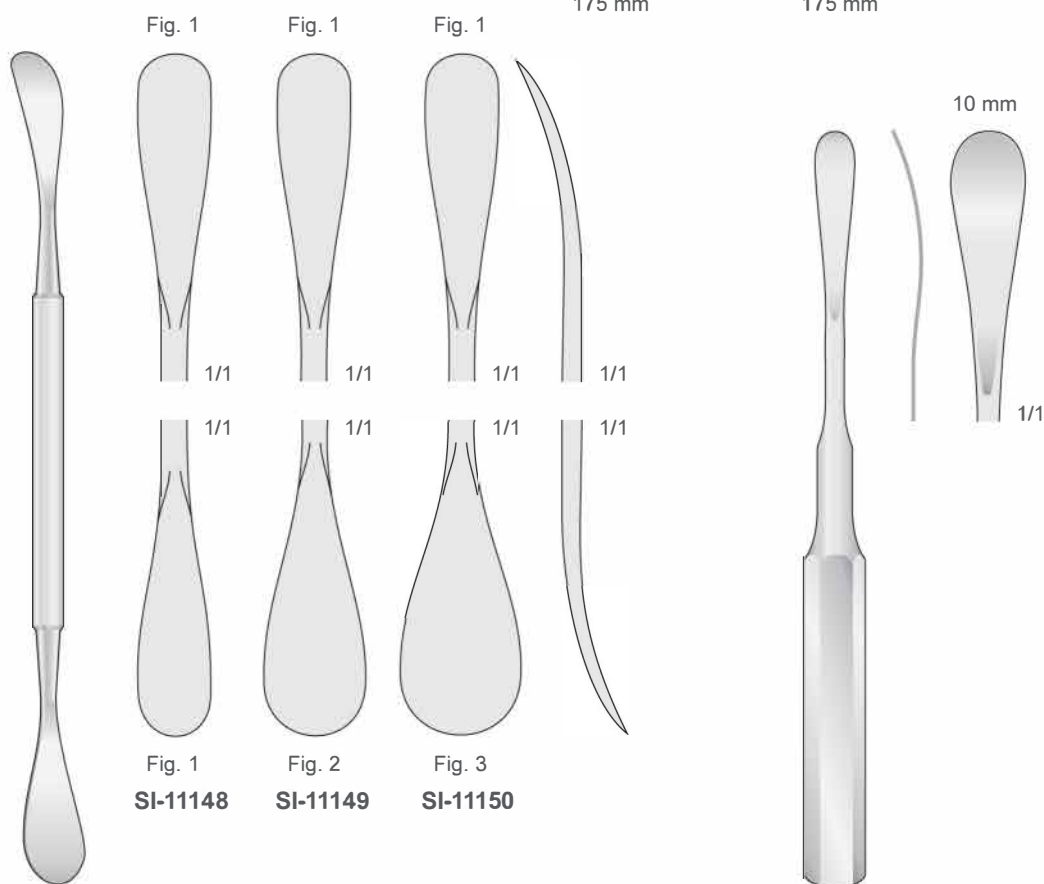

HENAHAN  
**SI-11151**  
 200 mm

MOLT  
**SI-11152**  
 160 mm



Raspatorien - Elevatorien  
 Raspatories - Elevators  
 Periostotomi - Elevatori  
 Legras - Elevadores  
 Rugines - Elevateurs

Fig. 12S

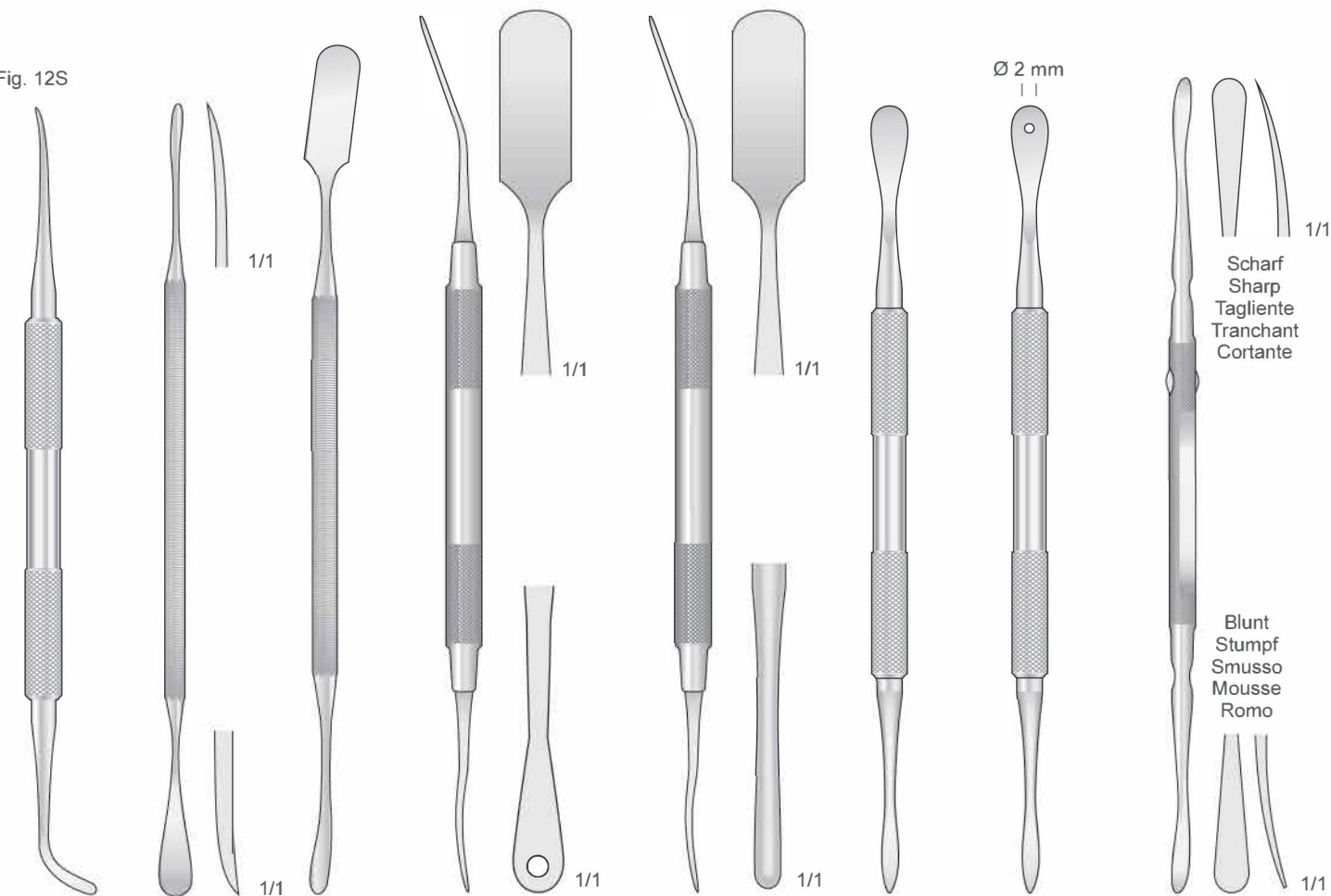

**BENNETT**  
**SI-11153**  
 175 mm

**SI-11154**  
 175 mm

**SI-11155**  
 190 mm

**PRICHARD**  
**SI-11156**  
 180 mm

**PRICHARD**  
**SI-11157**  
 175 mm

**MOLT**  
**SI-11158**  
 170 mm

**MOLT**  
**SI-11159**  
 170 mm

**SI-11160**  
 180 mm

Scharf  
 Sharp  
 Tagliente  
 Tranchant  
 Cortante

Blunt  
 Stumpf  
 Smusso  
 Mousse  
 Romo





Raspatorien - Elevatorien  
 Raspatories - Elevators  
 Periostotomi - Elevatori  
 Legras - Elevadores  
 Rugines - Elevateurs



**HOPKINS**  
**SI--11161**  
 185 mm

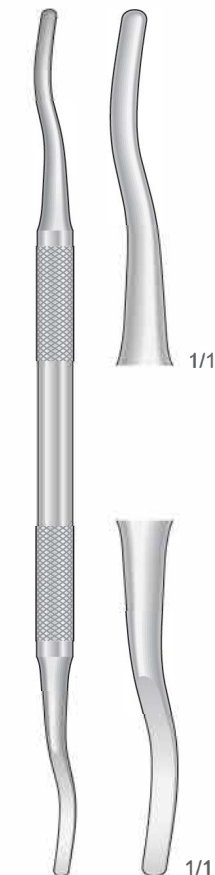

**HOPKINS**  
**SI--11162**  
 185 mm

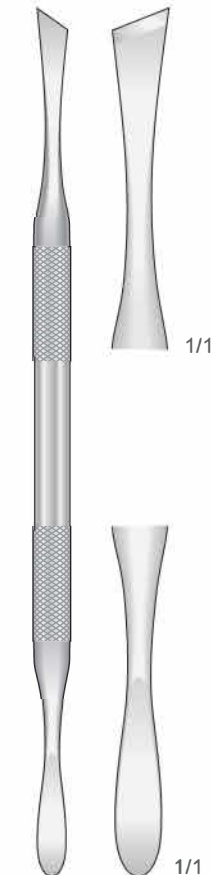

**MEAD**  
**si-11163**  
 185 mm

Instrumente für Sinuslift / Sinus Lift Instruments / Strumenti per rialzo del seno  
 Instrumentos para elevación de seno maxilar / Instruments d'élévation sinusienne



**si-11164**  
 160 mm



**SI-11165**  
 160 mm



**SI-11166**  
 180 mm

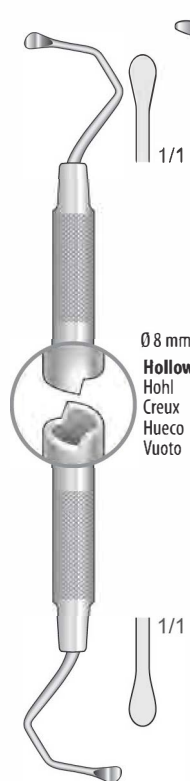

**SI-11166**  
 170 mm



**si-11167**  
 175 mm



**si-11168**  
 175 mm



**si-11168**  
 180 mm

Ø 8 mm  
**Hollow**  
 Hohl  
 Creux  
 Hueco  
 Vuoto



Raspatorien - Elevatorien  
 Raspatories - Elevators  
 Periostotomi - Elevatori  
 Legras - Elevadores  
 Rugines - Elevateurs

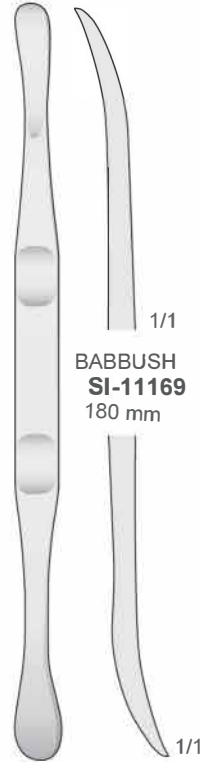

BABBUSH  
**SI-11169**  
 180 mm



1/1  
**SI-11170**  
 160 mm  
 Stumpf  
 Blunt  
 Smusso  
 Mousse  
 Romo



1/1  
**SI-11171**  
 160 mm  
 Scharf  
 Sharp  
 Tagliente  
 Tranchant  
 Cortante

Instrumente für Sinuslift  
 Sinus Lift Instruments

Strumenti per rialzo del seno  
 Instrumentos para elevación de seno maxilar  
 Instruments d'élevation sinusienne

Fig. 24G



MOLT  
**SI-11172**  
 180 mm



**SI-11173**  
 175 mm



WOODSON  
**SI-11174**  
 170 mm

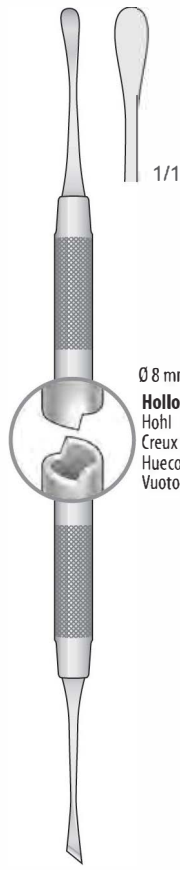

Ø 8 mm  
 Hollow  
 Hohl  
 Creux  
 Hueco  
 Vuoto

**SI-11175**  
 175 mm



**SI-11176**  
 175 mm



**SI-11177**  
 165 mm



**SI-11178**  
 170 mm



Raspatorien - Elevatorien  
Raspatories - Elevators  
Periostotomi - Elevatori  
Legras - Elevadores  
Rugines - Elevateurs

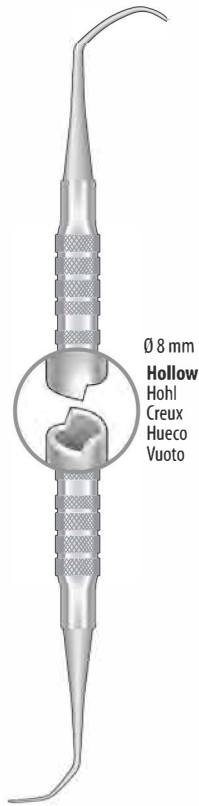

Ø 8 mm  
**Hollow**  
Hohl  
Creux  
Hueco  
Vuoto

SI-11179

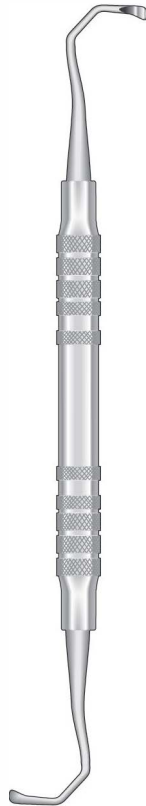

SI-11180



SI-11181



SI-11182



SI-11183



SI-11184



SI-11185



Ø 8 mm  
**Hollow**  
Hohl  
Creux  
Hueco  
Vuoto

SI-11186



Küretten  
Curettes  
Curetas  
Curettes

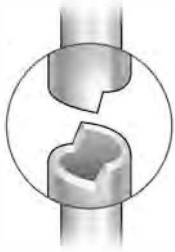

Runder Hohlgriff 8 mm  
Hollow Round Handle 8 mm  
Manico tondo vuoto 8 mm  
Mango hueco 8 mm  
Manche rond vide 8 mm



**HEMINGWAY**  
**SI-11195**  
180 mm

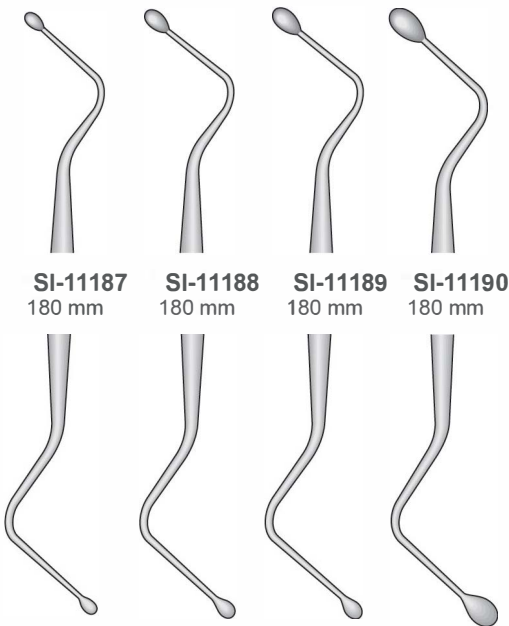

**SI-11187** 180 mm  
**SI-11188** 180 mm  
**SI-11189** 180 mm  
**SI-11190** 180 mm

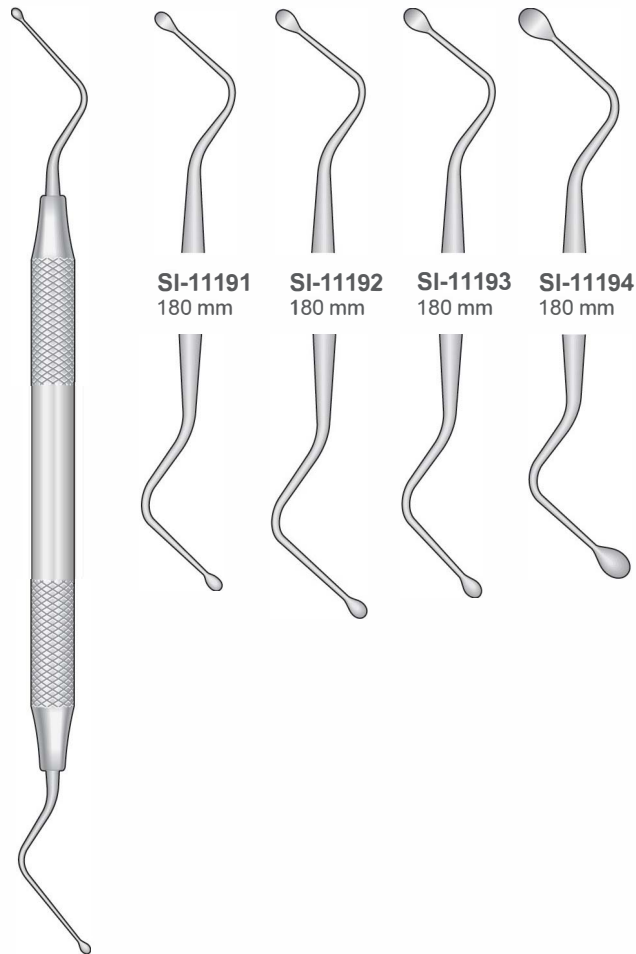

**LUCAS**  
**SI-11196**  
180 mm

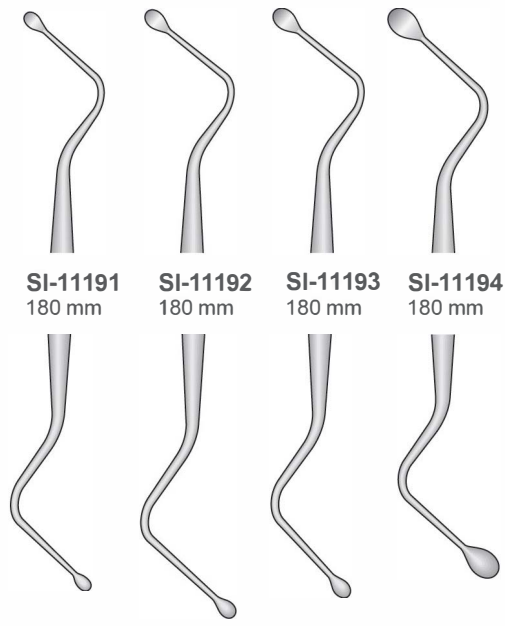

**SI-11191** 180 mm  
**SI-11192** 180 mm  
**SI-11193** 180 mm  
**SI-11194** 180 mm



Küretten  
Curettes  
Curettes  
Curetas  
Curettes

Wundhachen Mandibular  
Mandibular Nerve Diplace  
Per spostamento  
nervo mandibolare  
Para nero mandibular



**HEMINGWAY  
SI-11197**  
170 mm



**HEMINGWAY  
SI-11198**  
170 mm

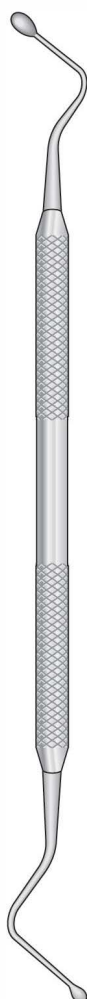

**HEMINGWAY  
11199**  
170 mm



**HEMINGWAY  
SI-11200**  
170 mm

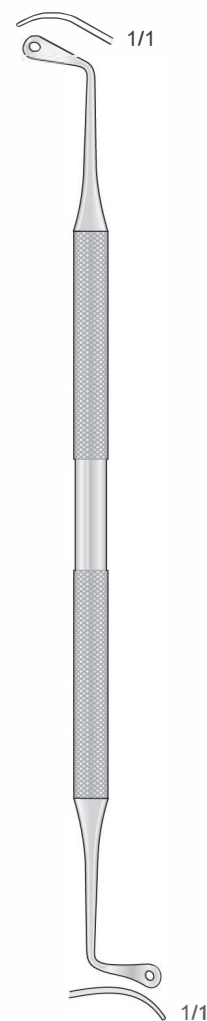

**SI-11201**  
165 mm



Küretten  
Curettes  
Curettes  
Curetas  
Curettes

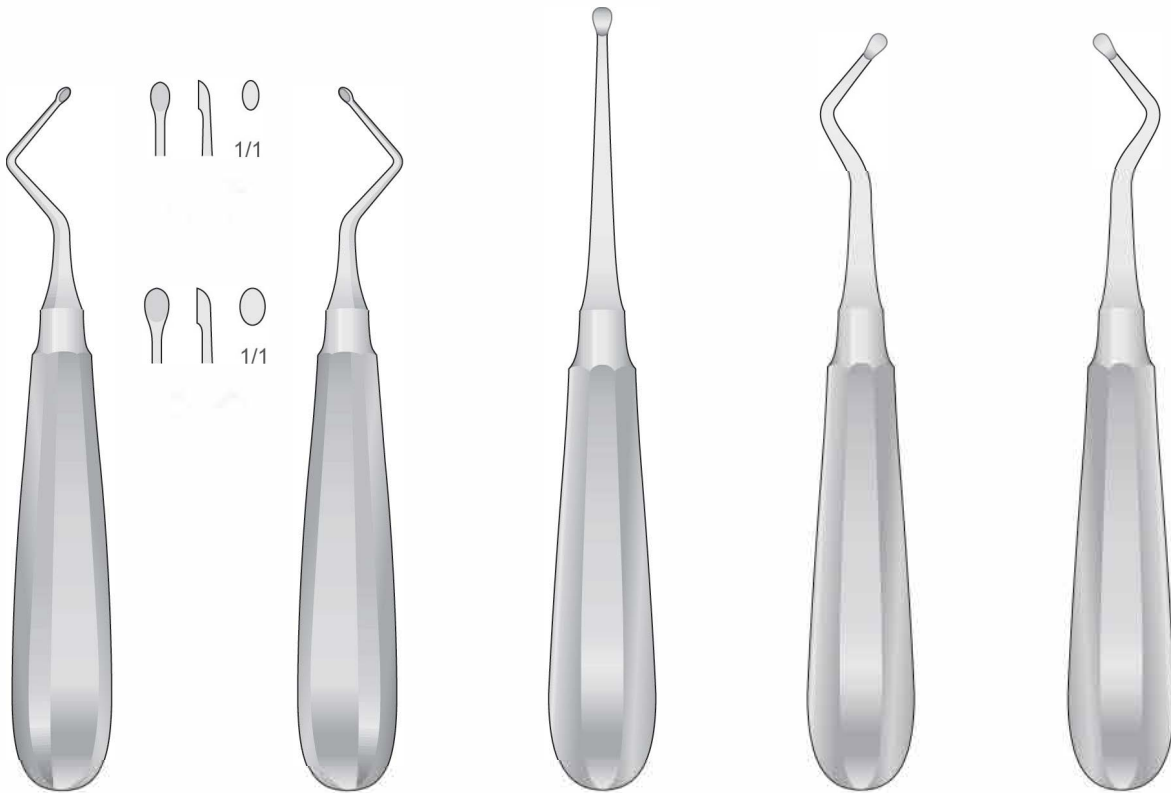

**KERPEL  
SI-11202**

145 mm

**KERPEL  
SI-11204**

145 mm

**SI-11206**

155 mm

**SI-11207**

150 mm

**SI-11208**

150 mm



**SI-11211**

160 mm

**JANSEN  
SI-11212**

160 mm

**UFFENORDE  
SI-11213**

170 mm

**UFFENORDE  
SI-11214**

170 mm

**WILLIGER  
SI-11215**

170 mm

**Fig. 00  
3,4 mm**



1/1

**SI-11209**

**Fig. 1  
5,2 mm**



1/1

**SI-11210**





Gewebezängchen  
Tissue Nippers  
Tronchesi per gengive e tessuti  
Pinzas para cortar tejidos  
Pinces coupante pour tissue

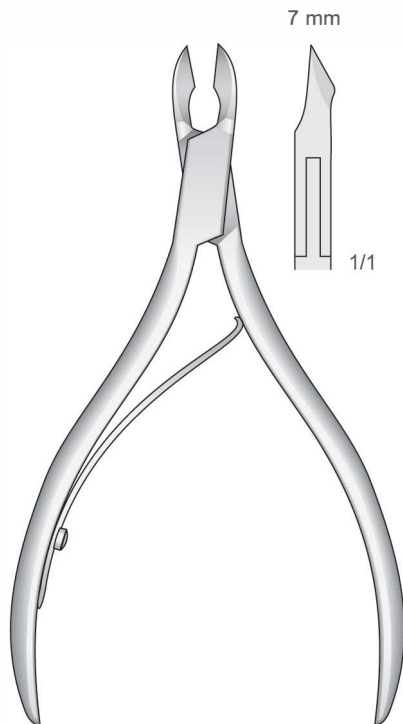

**CHOEN**  
**SI-11216**  
105 mm

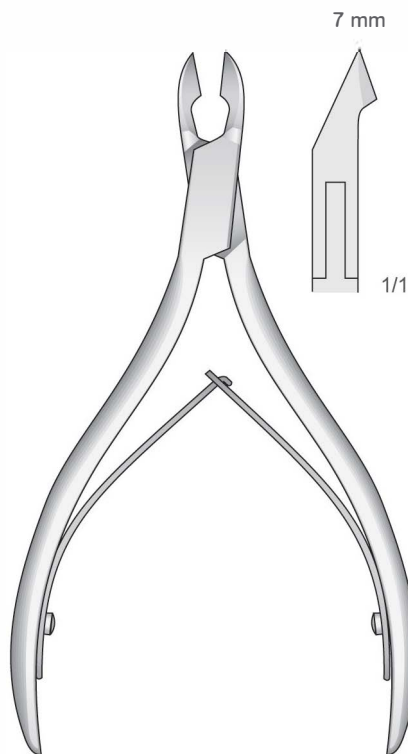

**ILIC**  
**SI-11217**  
115 mm

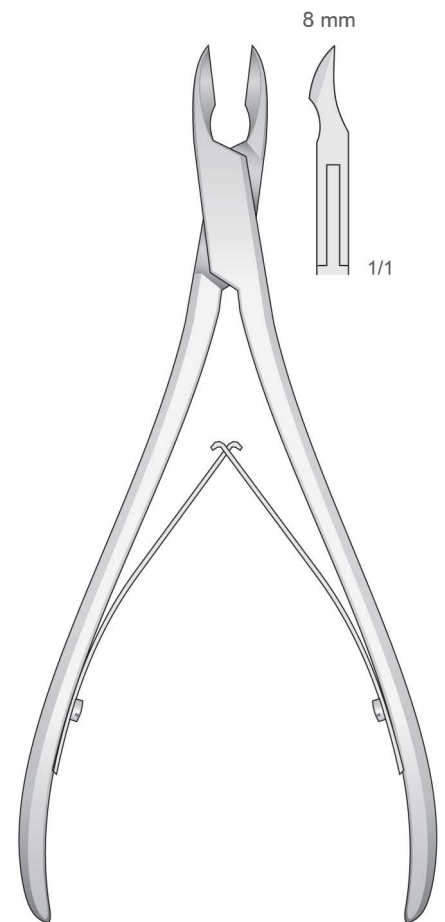

**SI-11218**  
140 mm



Hohlmeißelzangen  
 Bone rongeurs  
 Pinze ossivore  
 Pinzas gubias  
 Pincès gouges

S-Form

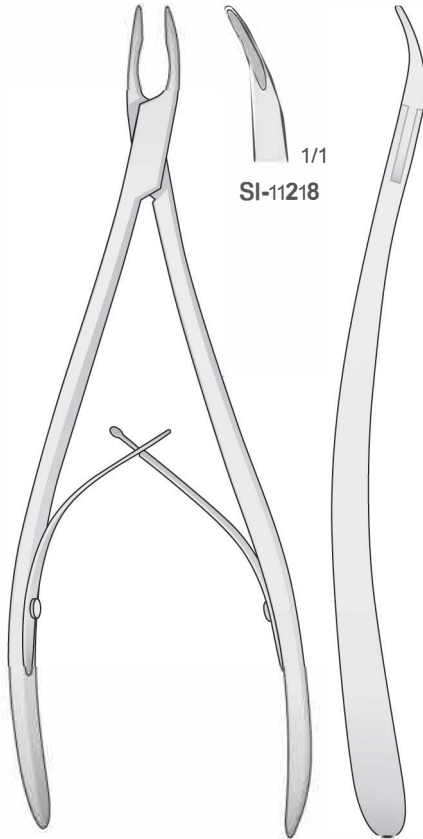

SI-11218



11219 1/1  
 11220 1/1

STELLBRINK  
 SI-11221  
 190 mm

STELLBRINK  
 SI-11222  
 170 mm

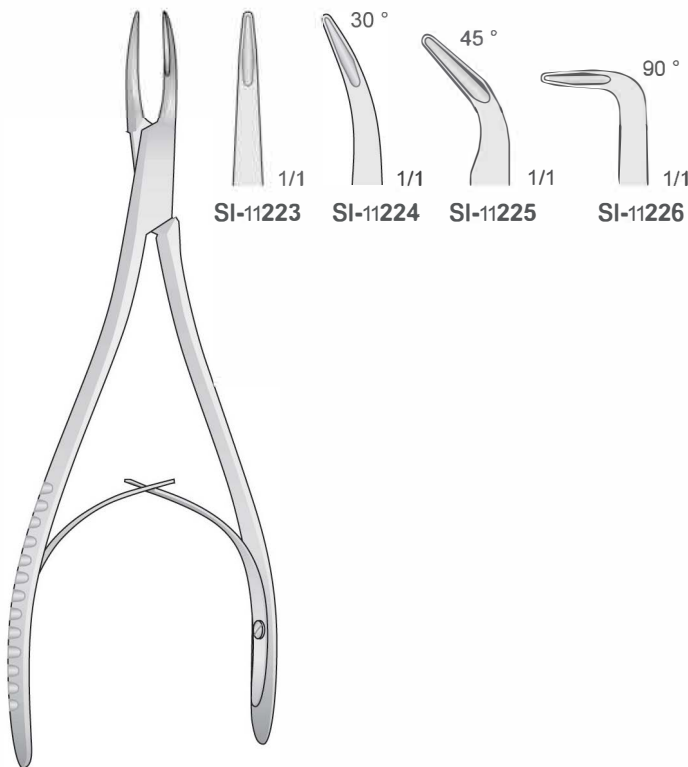

SI-11223 1/1  
 SI-11224 1/1  
 SI-11225 1/1  
 SI-11226 1/1

MINI-FRIEDMANN  
 SI-11228  
 150 mm

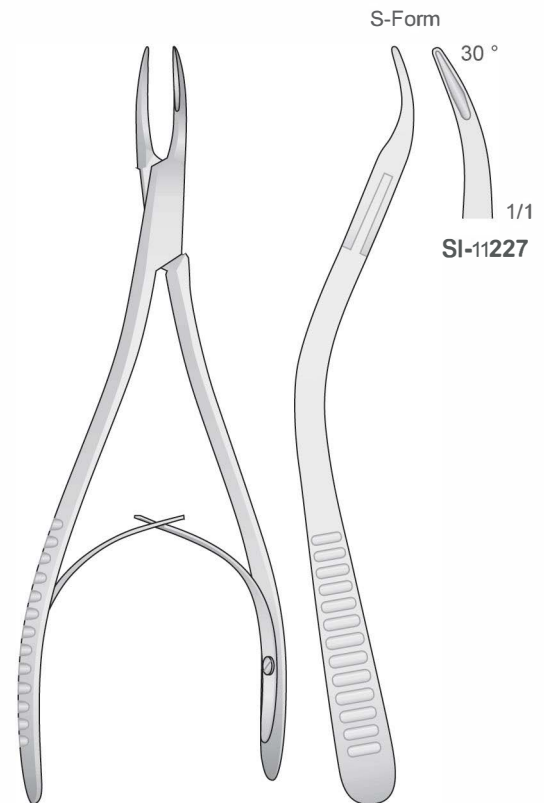

SI-11227 1/1

MINI-FRIEDMANN  
 SI-11229  
 145 mm



Hohlmeißelzangen  
 Bone rongeurs  
 Pinze ossivore  
 Pinzas gubias  
 Pincas gouges

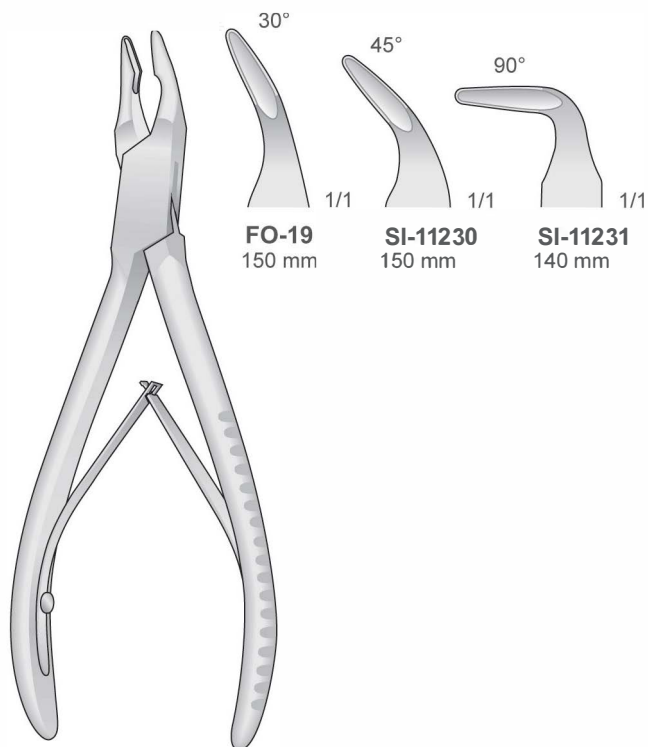

**BLUMENTHAL**  
**SI-11232**

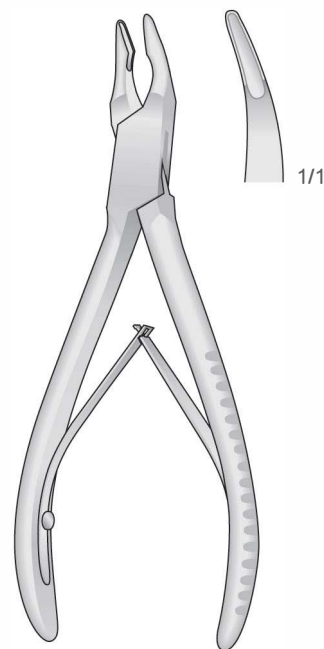

**MINI FRIEDMAN**  
**SI-11233**  
 120 mm

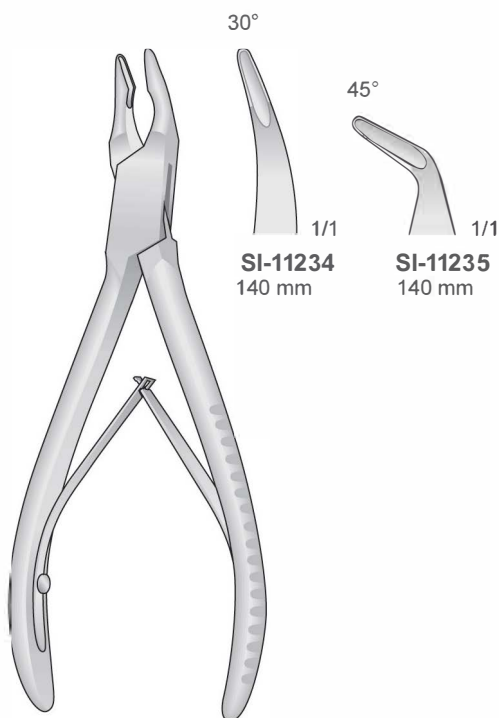

**FRIEDMANN**  
**SI-11237**  
 140 mm

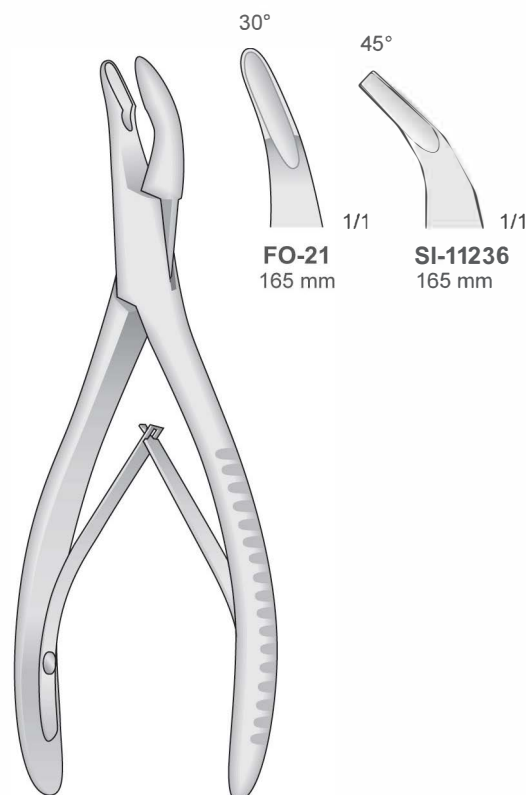

**MEAD**  
**SI-11238**  
 165 mm



Honimeiseizangen  
Bone rongeurs  
Pinze ossivore  
Pinzas gubias  
Pincas gouges

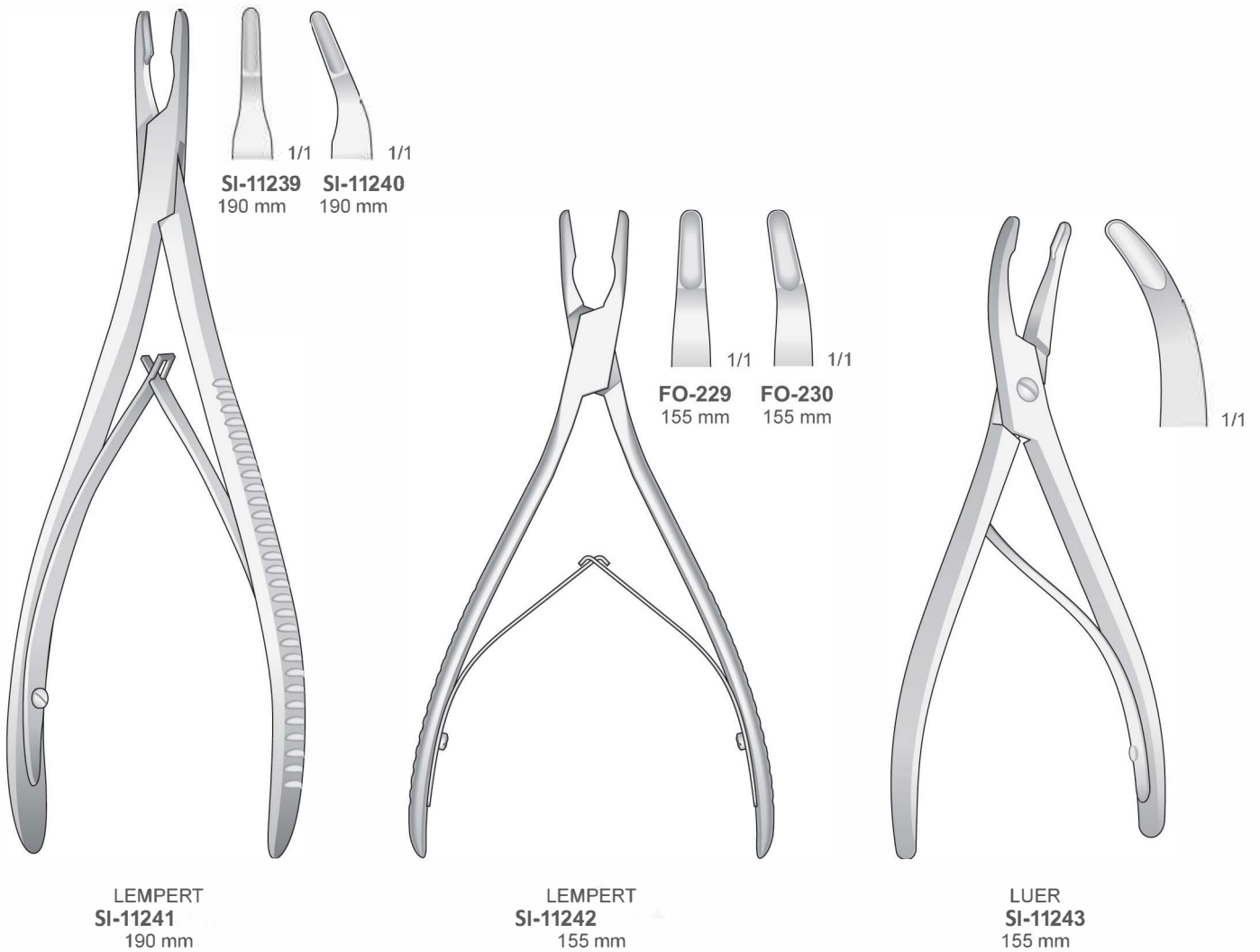



Hohlmeißelzangen  
Bone rongeurs  
Pinze ossivore  
Pinzas gubias  
Pincas gougues

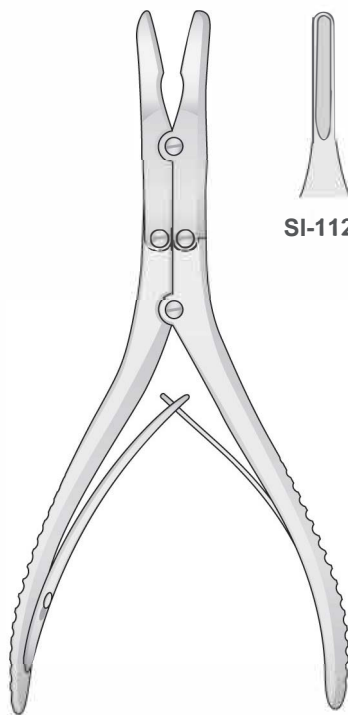

**RUSKIN**  
**SI-11285**  
150 mm

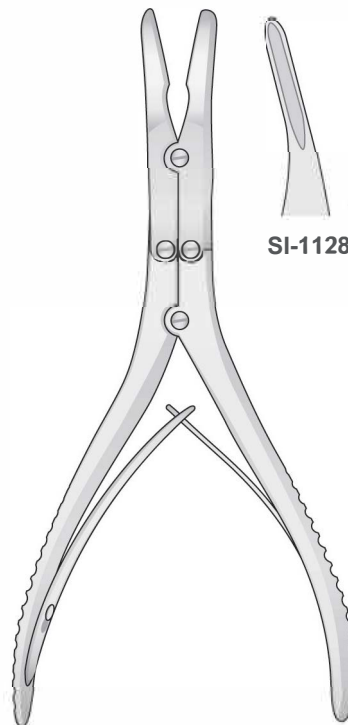
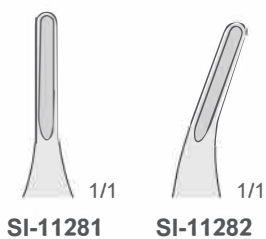

**KLEINERT-KUTZ**  
**SI-11286**  
155 mm

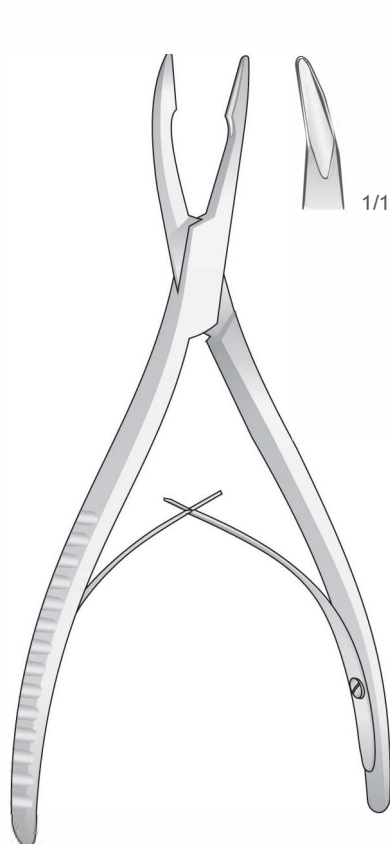

**FRIEDMANN**  
**SI-11287**  
160 mm

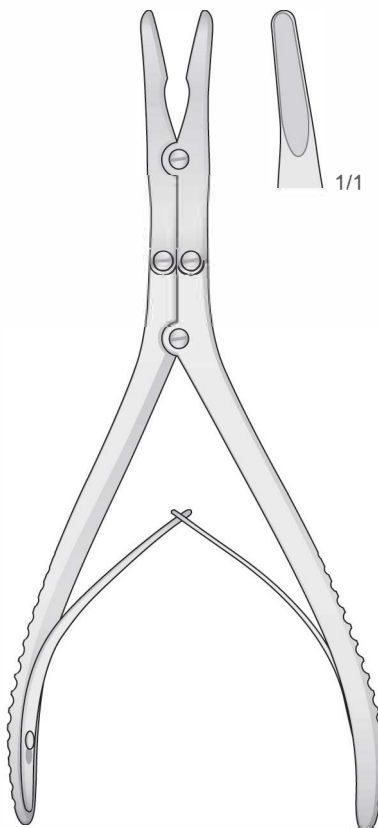

**BEYER**  
**SI-11288**  
180 mm

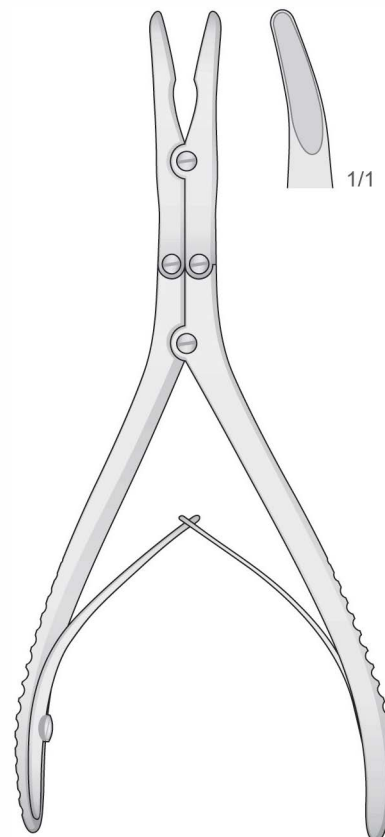
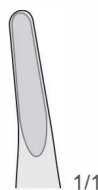

**ZAUFAL-  
JANSEN SI-11289**  
180 mm

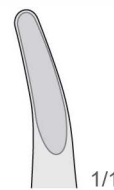



Hohlmeißelzangen  
Bone rongeurs  
Pinze ossivore  
Pinzas gubias  
Pincas gouges

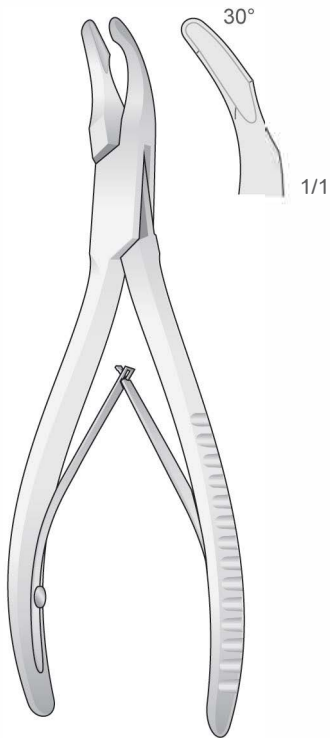

CLEVELAND  
**SI-11290** 140 mm  
**SI-11291** 170 mm

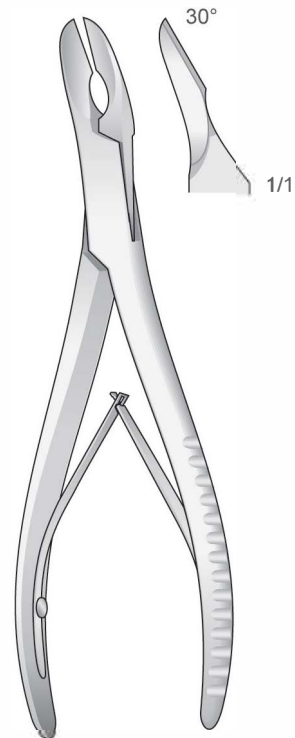

CLEVELAND  
**SI-11292** 150 mm  
**SI-11293** 170 mm

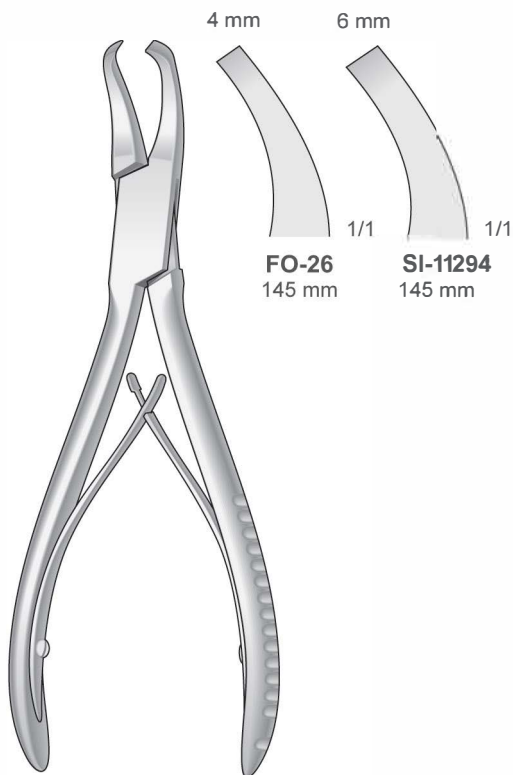

GARDNER  
**SI-11296**  
145 mm

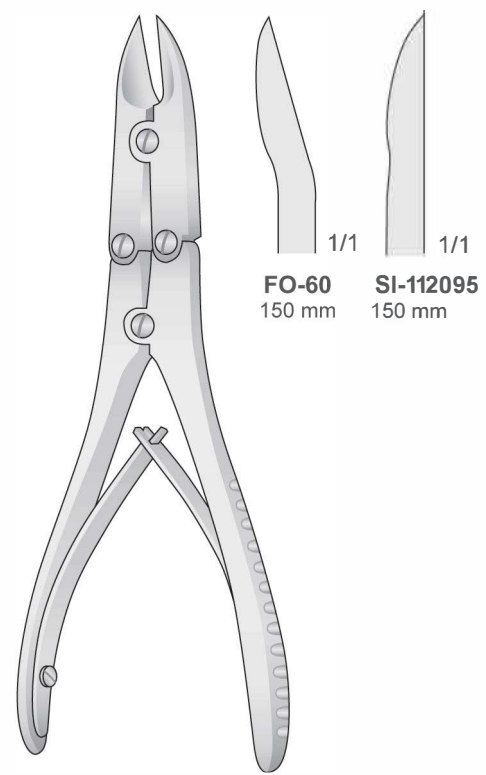

BÖHLER  
**SI-11297**  
150 mm





Zahnsonden  
Explorers - Sickle Probes  
Esploratori - Sonde falce  
Sondas exploradoras  
Sondes exploratrices

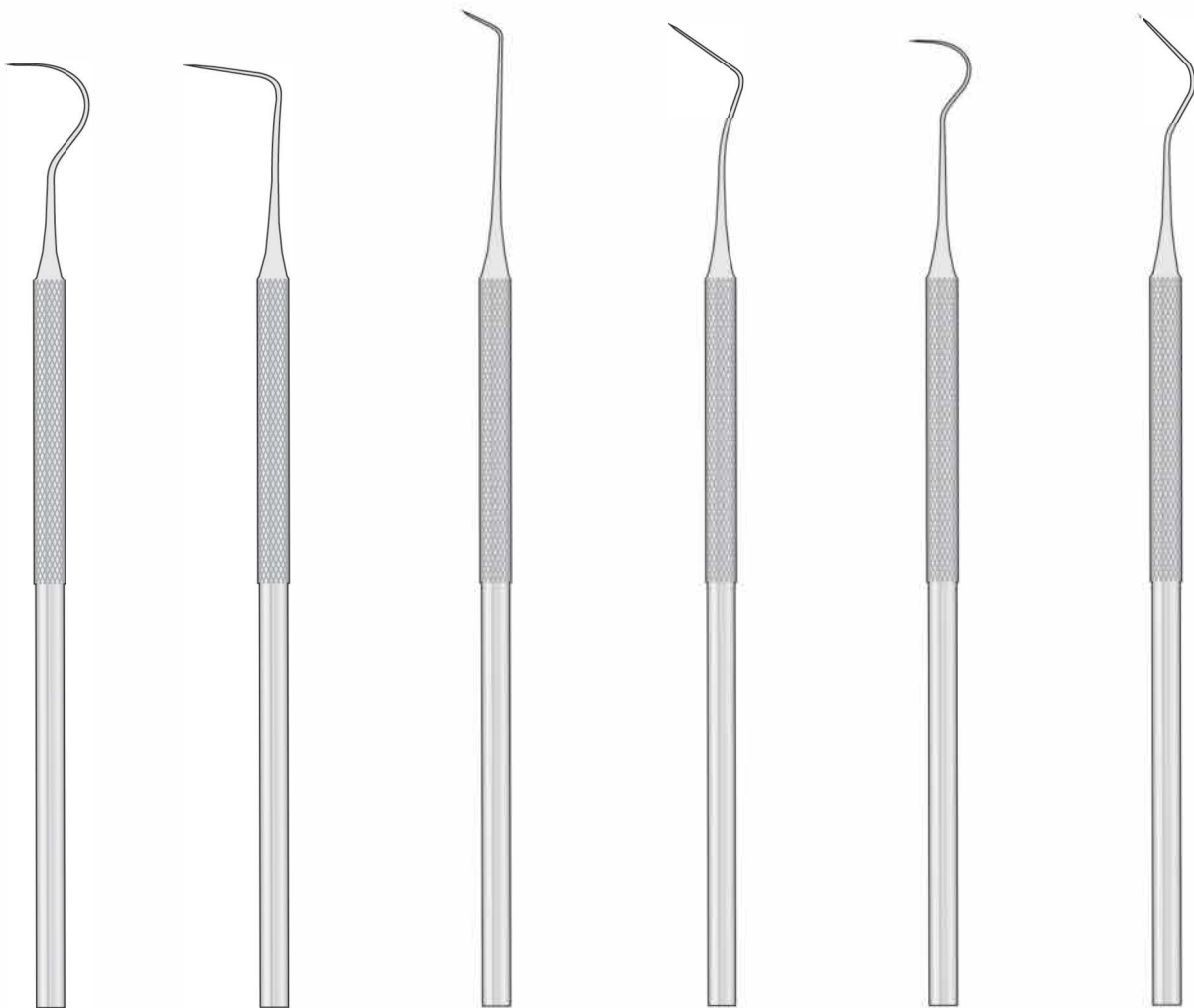

**SI-11298**  
Fig. 23

**SI-11299**  
Fig. 11

**SI-11300**  
Fig. 6

**SI-11301**  
Fig. 9

**SI-11302**  
Fig. 2

**SI-11303**  
Fig. 10



Zahnsonden  
Explorers - Sickle Probes  
Esploratori - Sonde falce  
Sondas exploradoras  
Sondes exploratrices

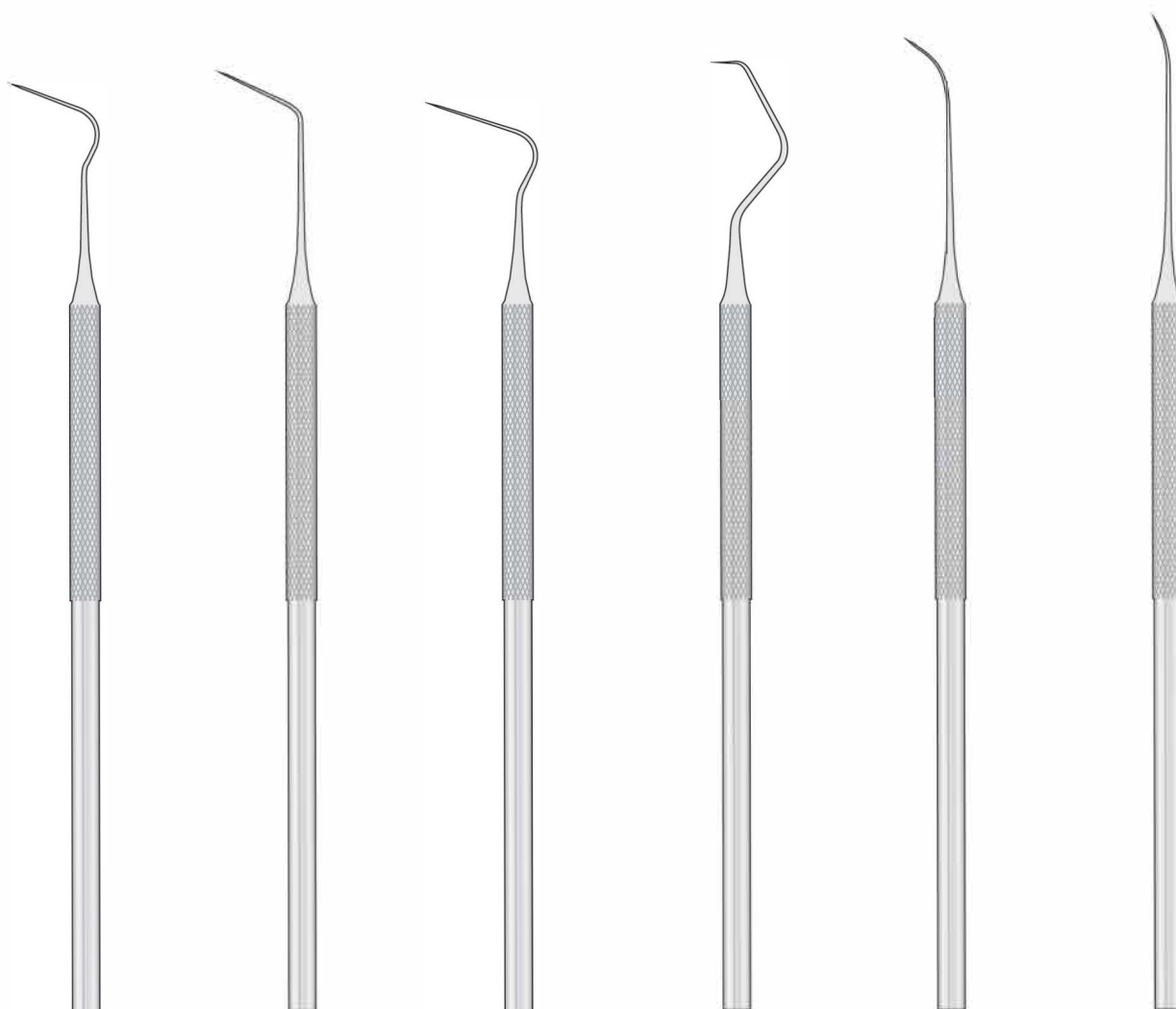

**SI-11304**  
Fig. 12

**SI-1130S**  
Fig. 6A

**SI-11306**  
Fig. 8A

**SI-11307**  
Fig. 17A

**SI-11308**  
Fig. 3A

**SI-11309**  
Fig. 3



Parodontometer  
Periodontal Probes  
Sonde parodontali  
Sondas parodontales  
Sondes parodontales

**Do not use Ultrasonic Cleaning**  
Verwenden Sie keine Ultraschall-Reinigung  
Ne pas utiliser nettoyage à ultrasons  
No usar limpieza ultrasónica  
Non usare lavatrici ad ultrasuoni



**Do not use metal brushes**  
Keine Drahtbürste verwenden  
Ne pas utiliser de brosses métalliques  
No utilizar cepillos metálicos  
Non utilizzare spazzole metalliche

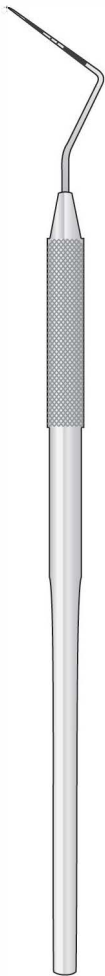

CP-11  
**SI-11310**  
160 mm

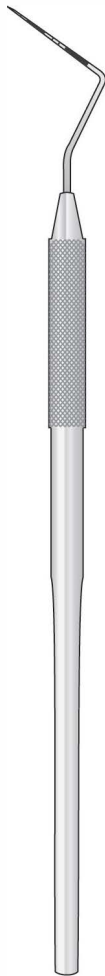

CP-12  
**SI-11311**  
160 mm

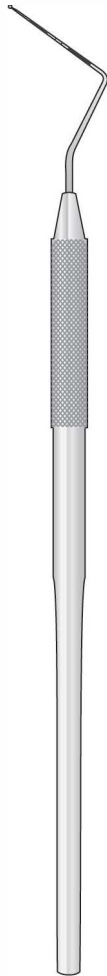

CP-12S  
**SI-11312**  
160 mm

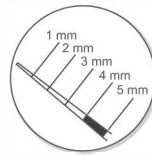

CP-15UNC  
**SI-11313**  
160 mm

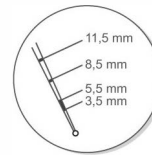

WHO  
**SI-11314**  
160 mm

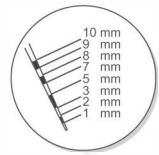

CP-10  
**SI-11315**  
160 mm



Parodontometer  
Periodontal Probes  
Sonde parodontali  
Sondas parodontales  
Sondes parodontales

Double-ended Explorer  
Doppelendiger Zahnsonden  
Sonde exploratrice double  
Sonda exploradora doble  
Sonda falce doppia



11/12 ODU  
SI-11316  
165 mm

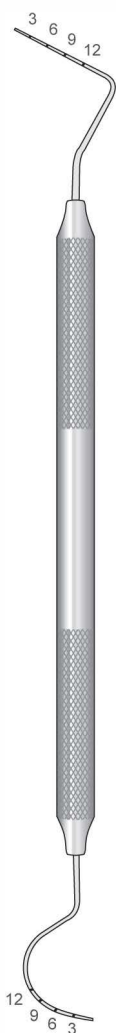

UT3/4 CATTONI  
SI-11317  
165 mm

3 - 6 - 9 - 12



12 - 9 - 6 - 3  
2QN NABERS  
SI-11318  
175 mm



23 CP-11  
SI-11319

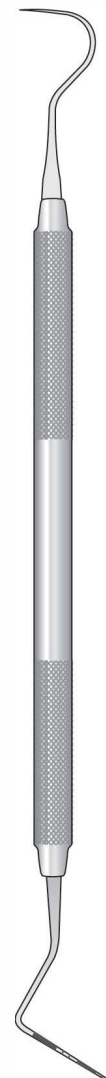

23 CP-12  
SI-11320



Parodontometer  
Periodontal Probes  
Sonde parodontali  
Sondas parodontales  
Sondes parodontales





Instrumente für Endodontie  
Endodontic Instruments  
Strumenti per Endonzia  
Instrumentos para Endodoncia  
Instruments pour Endodontie



LUKS  
SI-11327  
Fig.1

LUKS  
SI-11328  
Fig.2

LUKS  
SI-11329  
Fig.3

LUKS  
SI-11330  
Fig.4

SI-11331  
Fig.1

SI-11332  
Fig.2

SI-11333  
Fig.3

SI-11334  
Fig.4





Instrumente für Endodontie  
Endodontic Instruments  
Strumenti per Endodonzia  
Instrumentos para Endodoncia  
Instruments pour Endodontie

Spreaders

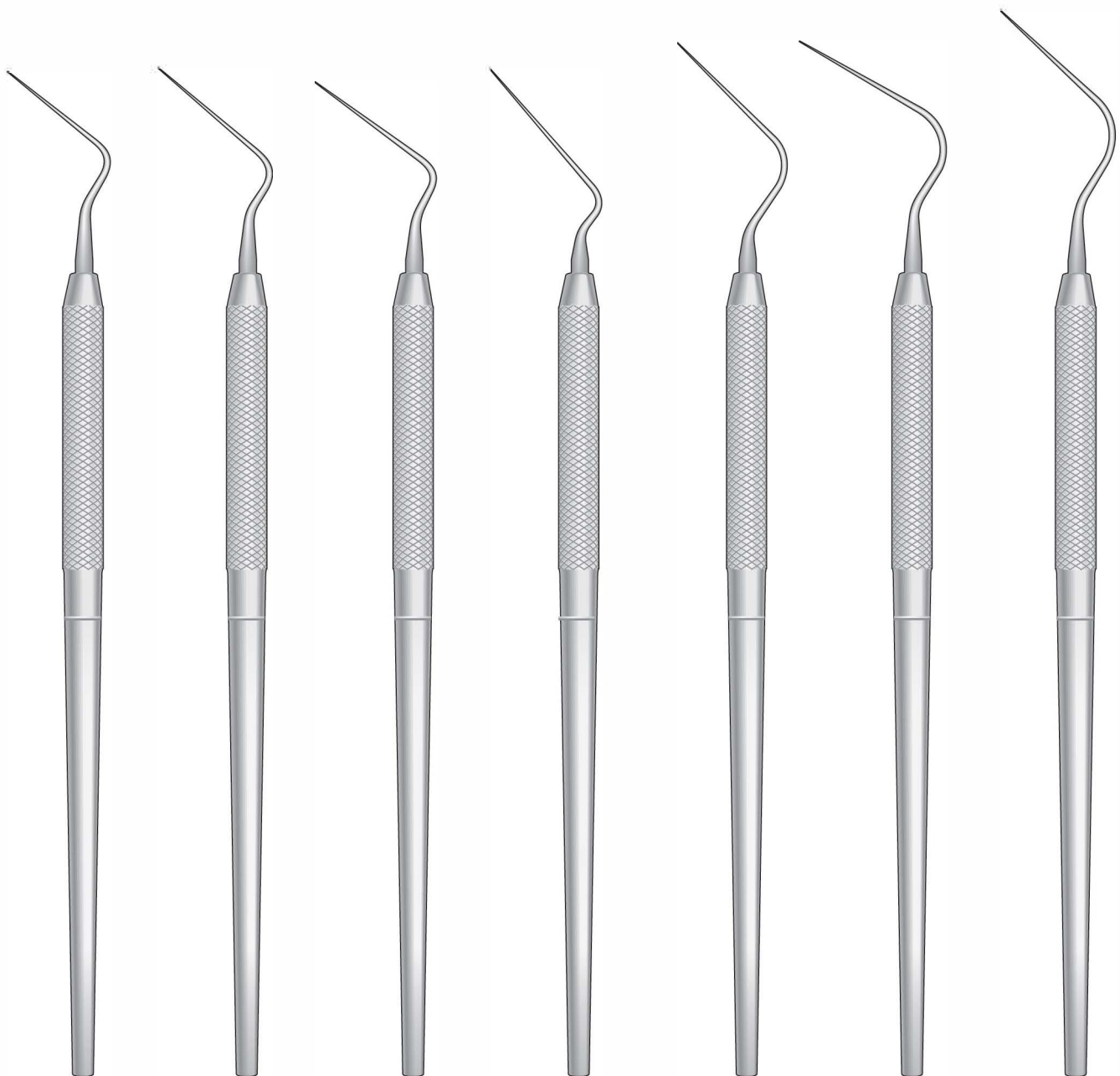

**SI-11335**  
Fig.1S

**SI-11335**  
Fig.2S

**SI-11336**  
Fig.D11

**SI-11337**  
Fig.MA57

**SI-11338**  
Fig.0

**SI-11399**  
Fig.00

**SI-11340**  
Fig.3



Mundspiegel und Griffe  
Mirrors and handles  
Specchietti e manici  
Espejos y mangos  
Miroirs et manches

Box of 12

SI-11341	# 3 - Ø 18mm	Flach Plane
SI-113042	# 4 - Ø 22mm	Piano Plano
SI-113043	# 5 - Ø 24mm	Plan

Rhodiumspiegel  
Rhodium Mirror  
Specchietto rodiato  
Espejo de rodio  
Miroir au rhodium

Box of 12

SI-11344	# 4 - Ø 22mm	11346
SI-11345	# 5 - Ø 24mm	11347

Simple Stem Cone Socket

Box of 12

SI-11348	# 3 - Ø 18mm	Hohl-Vergrößernd Concave with enlarging effect
SI-11349	# 4 - Ø 22mm	Concavo con ingrandimento
SI-11350	# 5 - Ø 24mm	Concavo con efecto de aumento Creux avec effect d'agrandissant

Box of 6

**RH-14** # 4 - Ø 22mm

**MEGA DUO RHODIUM n.4**

Beidseitig Rhodium Beschichtet  
Both sides Rhodium-coated  
Con rivestimento in rodio su entrambi i lati  
Revestido con rodio en ambos lados  
Revêtu de rhodium des deux côtés

Massiv - Solid  
Pieno - Sólido - Solide

Hohl - Hollow  
Vuoto - Hueco - Creux

SI-11351  
Simple Stem  
120 mm

MA-1A  
Cone Socket  
120 mm

SI-11353  
Simple Stem  
125 mm

SI-11354  
Cone Socket  
125 mm

inox STAINLESS STEEL

SI-11352  
120 mm

SI-11355  
125 mm

MA-7  
135 mm

Cr CHROMIUM

Al ALUMINIUM

inox STAINLESS STEEL





Mundspiegel und Griffe  
Mirrors and handles  
Specchietti e manici  
Espejos y mangos  
Miroirs et manches

Spiegeldurchmesser - Diameter of mirrors  
Diametro dello specchio - Diamètre des miroirs  
Diámetro de los espejos

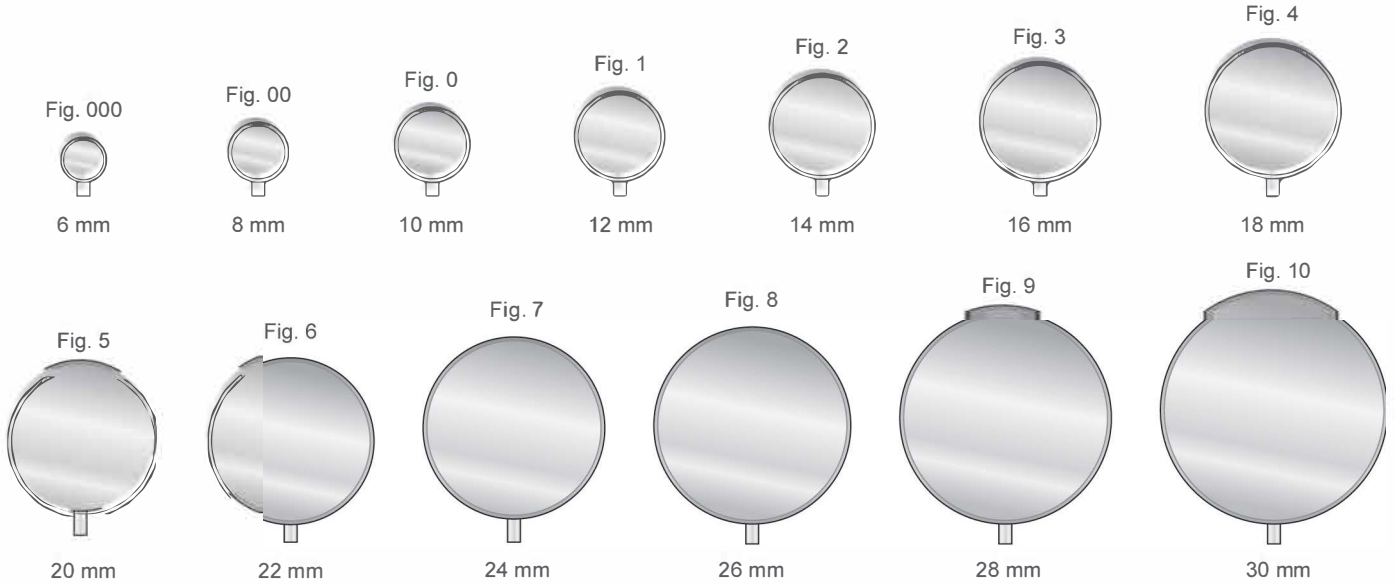

Kehlkopfspiegel mit Sechskantgriff  
Laryngeal mirrors with hexagonal handle  
Specchietto laringeo con manico esagonale  
Espejo laringeo con mango hexagonal  
Miroirs laryngiens avec manche hexagonal

- G-8 Fig. 00
- SI-11356 Fig. 0
- SI-11357 Fig. 1
- SI-11358 Fig. 2
- SI-113059 Fig. 3
- SI-11390 Fig. 4
- SI-11361 Fig. 5
- SI-11362 Fig. 6
- SI-11363 Fig. 7
- SI-11364 Fig. 8
- SI-11365 Fig. 9
- SI-11366 Fig. 10

SI-11376  
180 mm

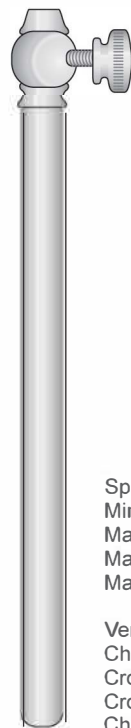

Spiegelgriff  
Mirrors handle  
Manico per specchietti  
Mango para espejos  
Manche à miroir

Verchromt  
Chromium  
Cromato  
Cromado  
Chromé

SI-11377  
120 mm



Kehlkopfspiegel  
Laryngeal mirrors  
Specchietto laringeo  
Espejos laringeos  
Miroirs laryngiens

- SI-11367 Fig. 000
- SI-11368 Fig. 00
- SI-11369 Fig. 0
- SI-11370 Fig. 1
- SI-11371 Fig. 2
- SI-11372 Fig. 3
- SI-11373 Fig. 4
- SI-11374 Fig. 5
- SI-11375 Fig. 6

SI-11378  
120 mm

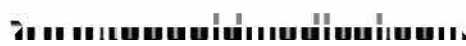



Dental-Spritzen  
Dental Syringes  
Siringhe dentali  
Jeringas dentales  
Seringues dentaires



**SI-11379**  
Aspirating  
for Imperial Tip  
(North America)  
140mm



**SI-11380**  
Self Aspirating  
for Imperial Tip  
(North America)  
140mm

**SI-11381**  
Self Aspirating  
for Metric Tip  
(Europe)  
140mm

Spritzen zur lokalen Interligamentär-Anästhesie  
Syringes for Intraligamental anaesthesia  
Siringa per anestesia intraligamentare  
Jeringa intraligamnetaria para anestesia  
Seringues pour anesthésies intraligamentaires

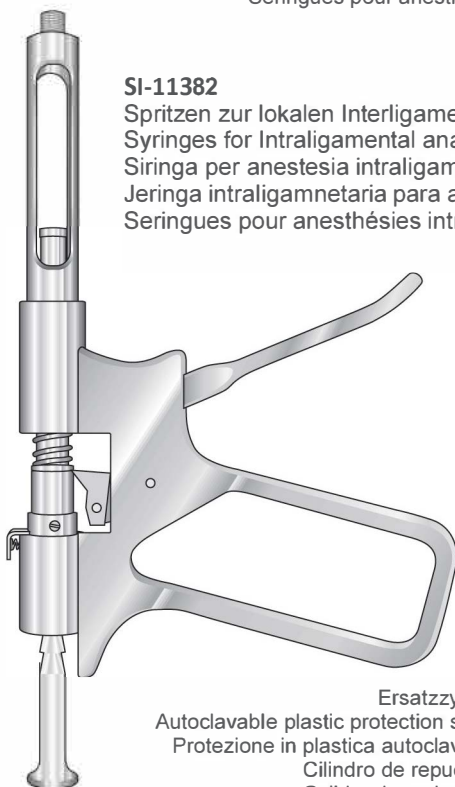

**SI-11382**  
Spritzen zur lokalen Interligamentär-Anästhesie  
Syringes for Intraligamental anaesthesia  
Siringa per anestesia intraligamentare  
Jeringa intraligamnetaria para anestesia  
Seringues pour anesthésies intraligamentaires



**SI-11384**  
Ersatzzylinder für SD-7  
Autoclavable plastic protection sleeve for SD-7  
Protezione in plastica autoclavabile per SD-7  
Cilindro de repuesto para SD-7  
Cylindre de rechange pour SD-7

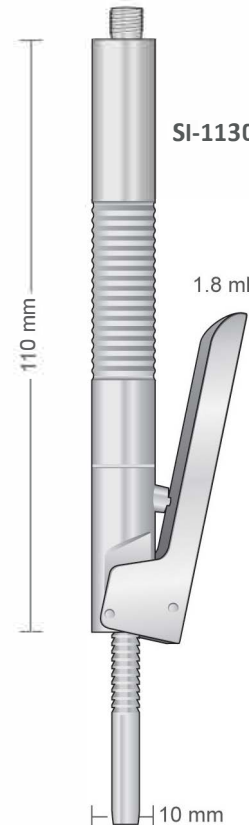

**SI-113083**

1.8 ml

110 mm

10 mm



Dental-Spritzen  
Dental syringes  
Siringhe dentali  
Jeringas dentales  
Seringues dentaires

Zylinder-Ampullen Spritzen  
Cartridge Syringes  
Siringhe per tubofiale  
Jeringas de ampollas  
Seringues d'ampoules

Aufsatz  
Spare cap only  
Adattatore solo  
Adaptador suelto  
Embout seul

Aufsatz  
Spare cap only  
Adattatore solo  
Adaptador suelto  
Embout seul

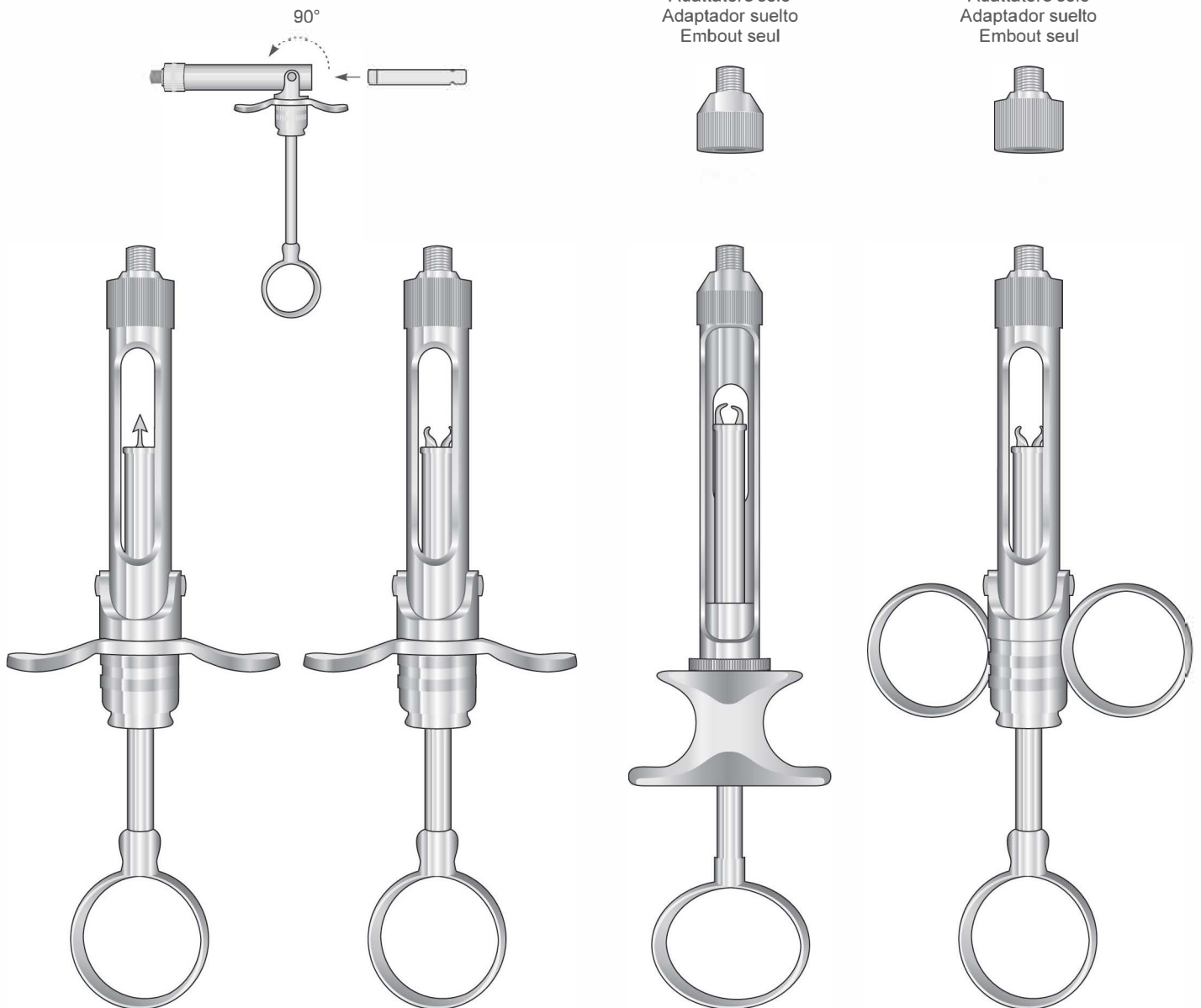

SI-11385

SI-11386

SI-11387

SI-11388  
130 mm



Küretten  
Curettes  
Curette  
Curetas  
Curettes



**GRACEY  
Si-11399**



**GRACEY  
Si-11389**



**GRACEY  
Si-11390**



**GRACEY  
Si-113891**



**GRACEY  
Si-11394**



**GRACEY  
Si-11395**



**GRACEY  
Si-11396**

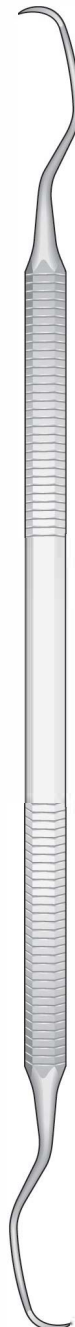

**LANGER Fig.1/2  
Si-11400**



**LANGER Fig.3/4  
Si-11392**



**COLUMBIA  
Si-11393**



**COLUMBIA  
Si-11397**



**COLUMBIA  
Si-11398**





## Elite Extra Thin

American made, German approved  
Elite Curettes



Ø 9 mm

Hollow  
Hohl  
Creux  
Hueco  
Vuoto



**Elite**  
Scaler und K retten  
Scalers and Curettes  
Scaler e Curette  
Raspadores y Curetas  
D tarteurs et Curettes



**SI-11401**  
Gracey  
Curette 1/2ET



**SI-11402**  
Gracey  
Curette 3/4ET



**SI-11403**  
Gracey  
Curette 5/6ET



**SI-11404**  
Gracey  
Curette 7/8ET



**SI-11405**  
Gracey  
Curette 9/10ET



**SI-11406**  
Gracey  
Curette 11/12ET



**SI-11407**  
Gracey  
Curette 13/14ET



**SI-11408**  
Gracey  
Curette 15/16ET

### Elite Scalers and Curettes Extra Thin

Balanced and ergonomic for great tactile working ability.

Extra light hollow handle for optimum comfort (feather weight / round Ø 9 mm).

Maintains long sharp edges.



## Elite

Scaler und Küretten  
Scalers and Curettes  
Scaler e Curette  
Raspadores y Curetas  
Détartreurs et Curettes



Hollow  
Hohl  
Creux  
Hueco  
Vuoto



Ø9 mm

*Elite*

American made, German approved  
Elite Scalers and Curettes



**SI-11409**  
Gracey  
Curette 1/2



**SI-11410**  
Gracey  
Curette 3/4



**SI-11411**  
Gracey  
Curette 5/6



**SI-11412**  
Gracey  
Curette 7/8



**SI-11413**  
Gracey  
Curette 9/10



**SI-11414**  
Gracey  
Curette 11/12



**SI-11415**  
Gracey  
Curette 13/14



**SI-11416**  
Gracey  
Curette 1/2S



**SI-11417**  
Gracey  
Curette 3/4S



**SI-11418**  
Gracey  
Curette 5/6S



**SI-11419**  
Gracey  
Curette 7/8S



**SI-11420**  
Gracey  
Curette 9/10S



**SI-11421**  
Gracey  
Curette 11/12S



**SI-11422**  
Gracey  
Curette 13/14S

### Elite Scalers and Curettes

Balanced and ergonomic for great tactile working ability.  
Extra light hollow handle for optimum comfort (feather weight / round Ø 9 mm).  
Maintains long sharp edges.



## Elite

American made, German approved  
Elite Scalers and Curettes



Hollow  
Hohl  
Creux  
Hueco  
Vuoto



Ø9 mm

**Elite**  
Scalers und Küretten  
Scalers and Curettes  
Scaler e Curette  
Raspadores y Curetas  
Déartreurs et Curettes



**SI-11423**  
Gracey  
Curette 1/2L



**SI-11424**  
Gracey  
Curette 3/4L



**SI-11425**  
Gracey  
Curette 5/6L



**SI-11426**  
Gracey  
Curette 7/8L



**SI-11427**  
Gracey  
Curette 9/10L



**SI-11428**  
Gracey  
Curette 11/12L



**SI-11429**  
Gracey  
Curette 13/14L



**SI-11430**  
Gracey  
Curette 15/16



**SI-11431**  
Gracey  
Curette 17/18S



**SI-11432**  
Kramer  
Curette 1



**SI-11433**  
Kramer  
Curette 3



**SI-11434**  
Kramer-Nevis  
Chisels 1/2



**SI-11435**  
McCall  
Scaler 11/12



**SI-11436**  
McCall  
Curette 13/14



**SI-11437**  
McCall  
Curette 13S/14S



**SI-11438**  
McCall  
Curette 17S/18S



**SI-11439**  
Columbia  
Curette 2RL



**SI-11440**  
Columbia  
Curette 4RL



**SI-11441**  
Columbia  
Curette 13/14



**SI-11442**  
Langer  
Curette 5/6



## Elite

Scaler und Kùretten  
Scalers and Curettes  
Scaler e Curette  
Raspadores y Curetas  
Détartreurs et Curettes



Hollow  
Hohl  
Creux  
Hueco  
Vuoto



Ø9 mm

# Elite

American made, German approved  
Elite Scalers and Curettes

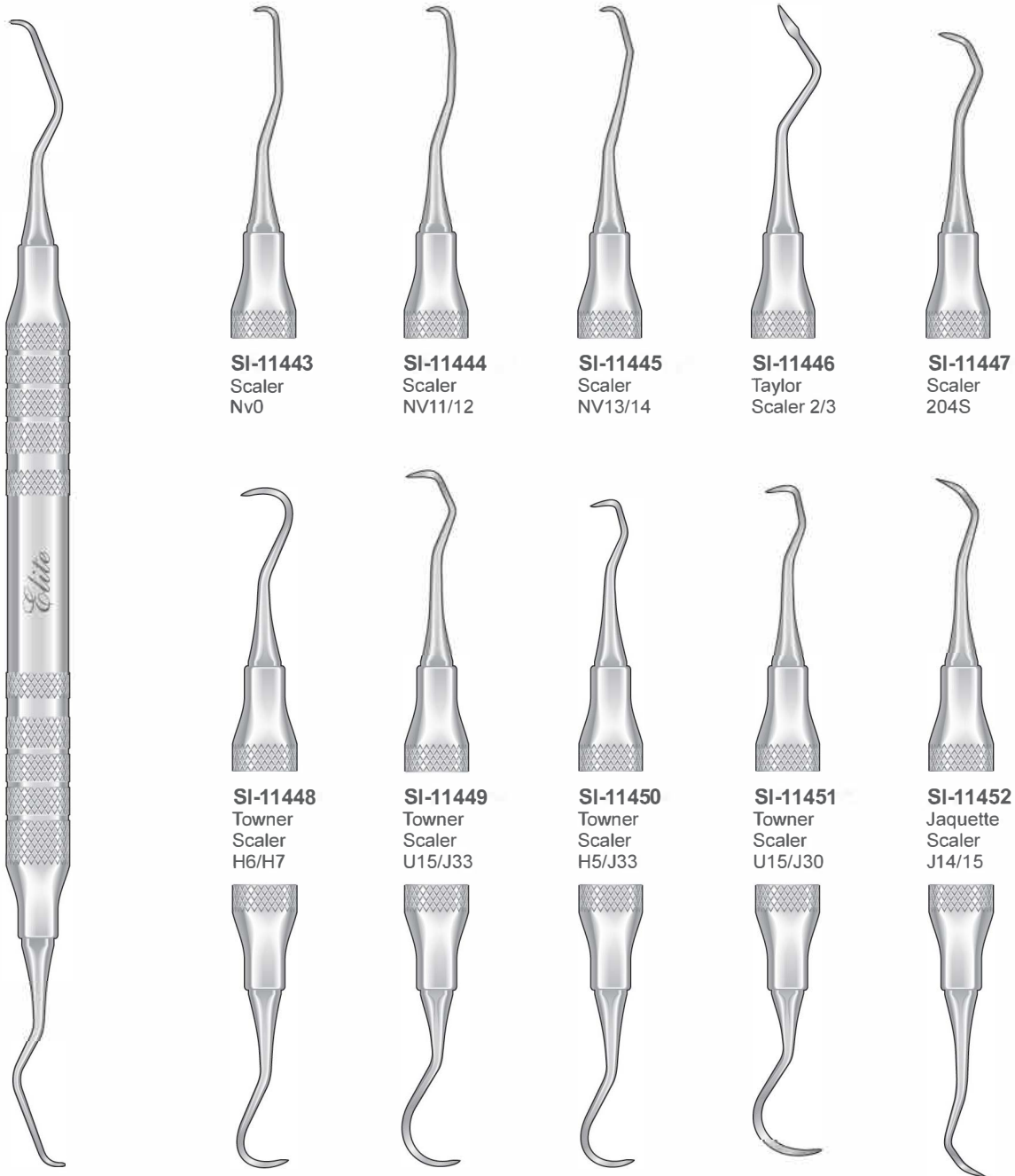

**SI-11443**  
Scaler  
NV0

**SI-11444**  
Scaler  
NV11/12

**SI-11445**  
Scaler  
NV13/14

**SI-11446**  
Taylor  
Scaler 2/3

**SI-11447**  
Scaler  
204S

**SI-11448**  
Towner  
Scaler  
H6/H7

**SI-11449**  
Towner  
Scaler  
U15/J33

**SI-11450**  
Towner  
Scaler  
H5/J33

**SI-11451**  
Towner  
Scaler  
U15/J30

**SI-11452**  
Jaquette  
Scaler  
J14/15

### Elite Scalers and Curettes

Balanced and ergonomic for great tactile working ability.  
Extra light hollow handle for optimum comfort (feather weight / round Ø 9 mm).  
Maintains long sharp edges.



Küretten - Feilen  
Curettes - Files  
Curette - Lime  
Curetasc - Lima  
Curettes - Limes

Universal Küretten  
Universal Curettes  
Curette universali  
Curetas universales  
Curettes universelles

Parodontalfeilen  
Periodontal Files  
Lime parodontali  
Limas parodontales  
Limes parodontales

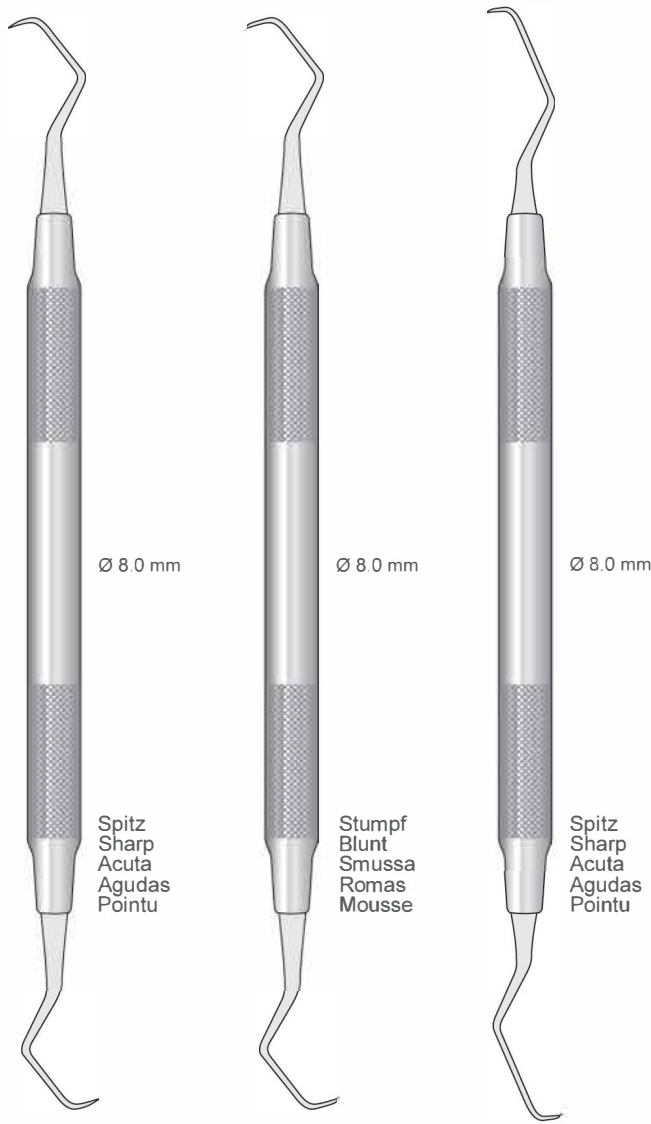

**SI-11453**  
165 mm

**SI-11454**  
165 mm

**SI-11455**  
170 mm

**HIRSCHFELD**  
**SI-11456**  
170 mm

**HIRSCHFELD**  
**SI-11457**  
170 mm

**HIRSCHFELD**  
**SI-11458**  
175 mm



Amalgamträger  
Amalgam Carriers  
Porta amalgama  
Porta-amalgamas  
Porte-amalgames

Amalgambecher  
Amalgam Well  
Mortajo per amalgama  
Vaso para amalgama  
Gobelet pour amalgame



**SI-11459**  
Ø 35 mm  
h. 35 mm



**SI-11460**

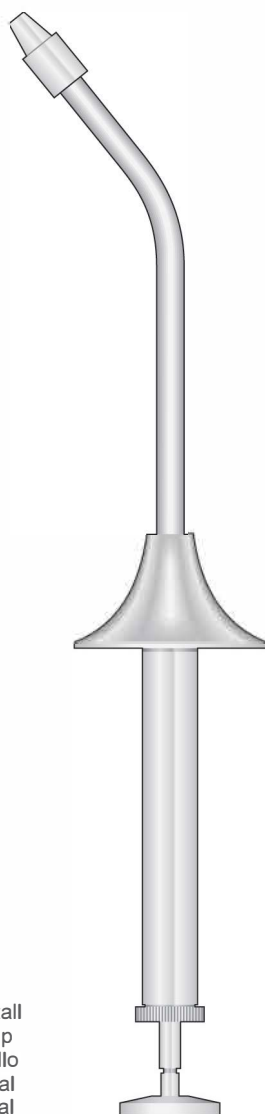

**SI-11461**

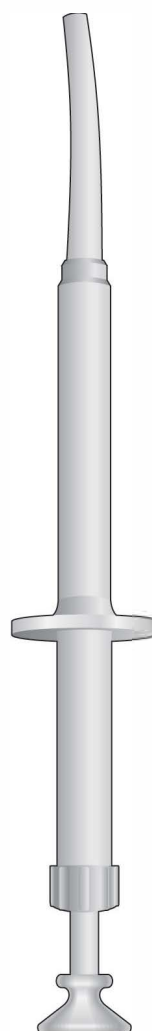

**SI-11462**  
170 mm

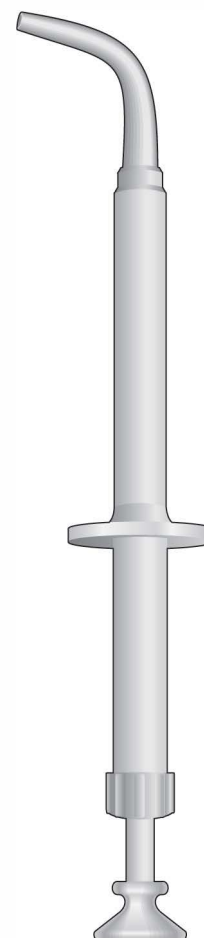

**SI-11463**  
160 mm

Aus Metall  
Metal tip  
In metallo  
De metal  
En métal

Autoclavable

Aus Kunststoff  
Plastic tip  
In plastica  
De plàstic  
En plastique





Amalgam Instrumente  
 Amalgam Carvers  
 Strumenti per modellare l'amalgama  
 Instrumentos para modelar las obturaciones  
 Instruments à modeler l'amalgame

Instrument für Drahrückzug  
 Instrument for retractor wire  
 Strumento per filo retrattore  
 Instrumento para hilo separador  
 Instruments pour fil séparateur

Cleoids - Discoids

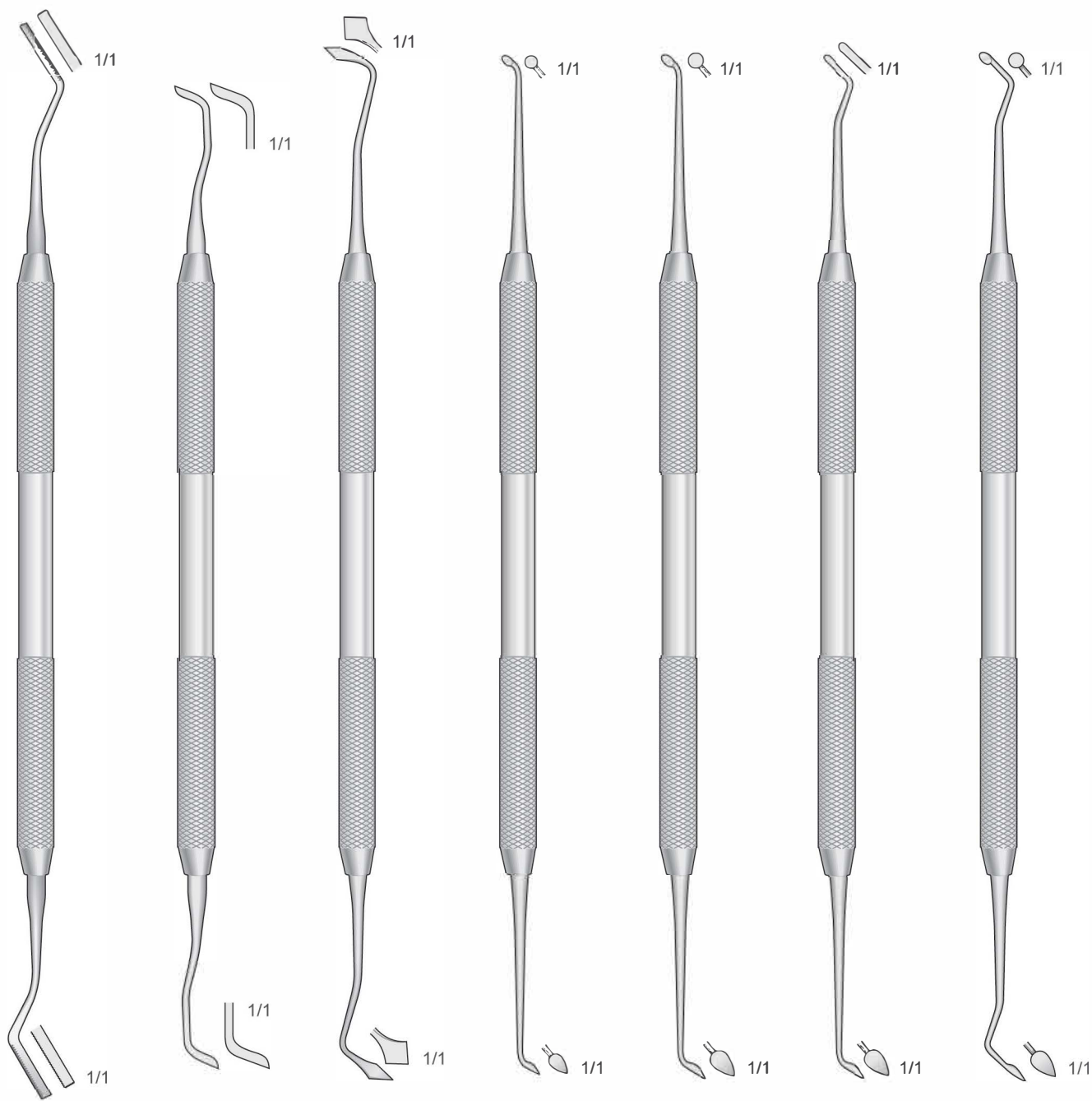

**SI-11464**

**SI-11465**  
USC

**SI-11466**  
FRAHM

**SI-11467**  
Fig. 1 / 2

**SI-11468**  
Fig. 4/5

**SI-11469**  
Fig. W.A.C.D.

**SI-11470**  
Fig. 3/6



Fullungsinstrumente  
Filling Instruments  
Strumenti per otturazione  
Instrumentos para obturación  
Instruments pour obturation

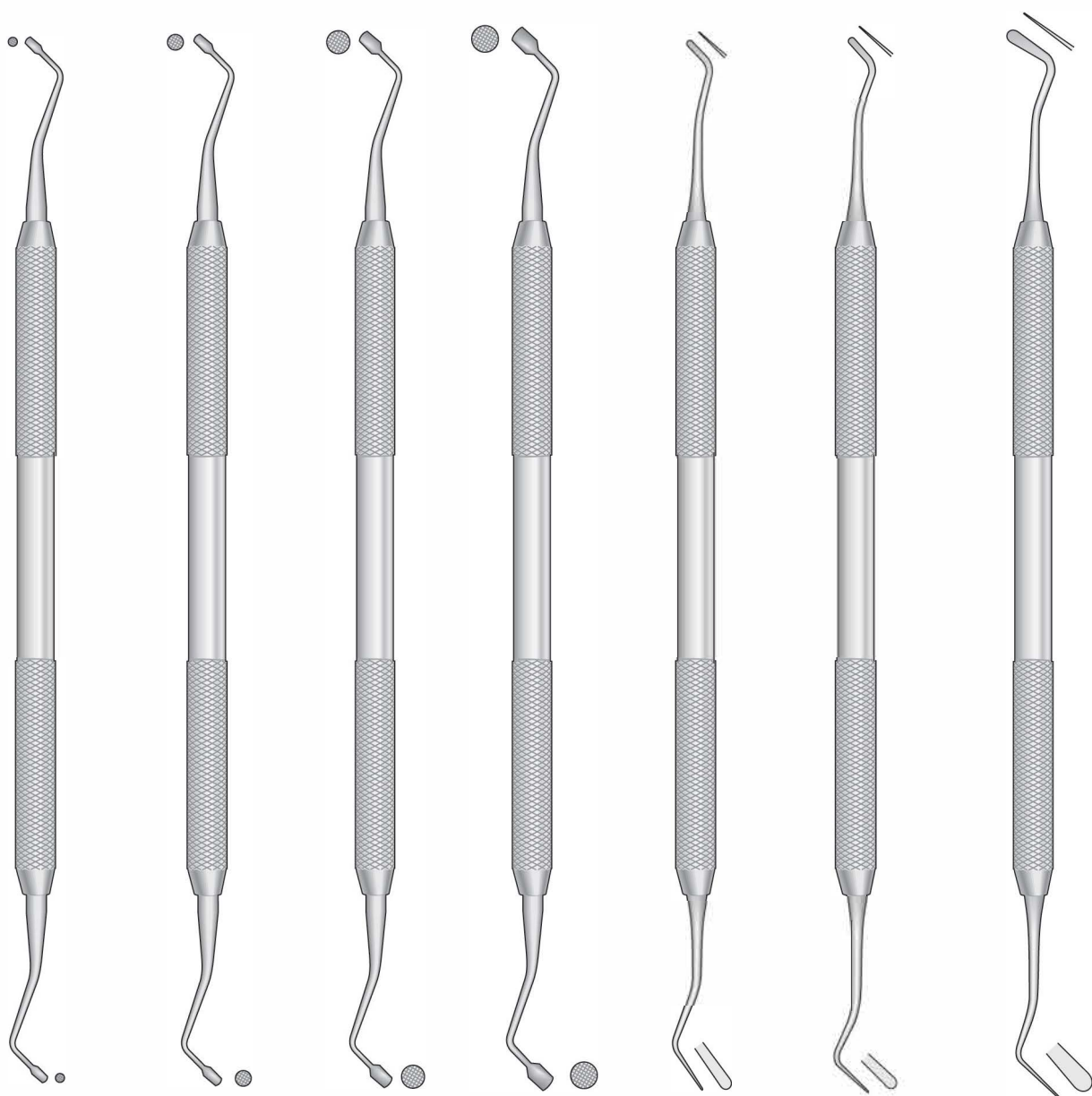

SI-11471

SI-11472

SI-11473

SI-11474

SI-11475

SI-11476

SI-11477



Füllungsinstrumente  
Filling Instruments  
Strumenti per otturazione  
Instrumentos para obturación  
Instruments pour obturation

Gerieft  
Serrated  
Zigrinati  
Estríados  
Striée

Glatt  
Smooth  
Lisci  
Lisos  
Lissée

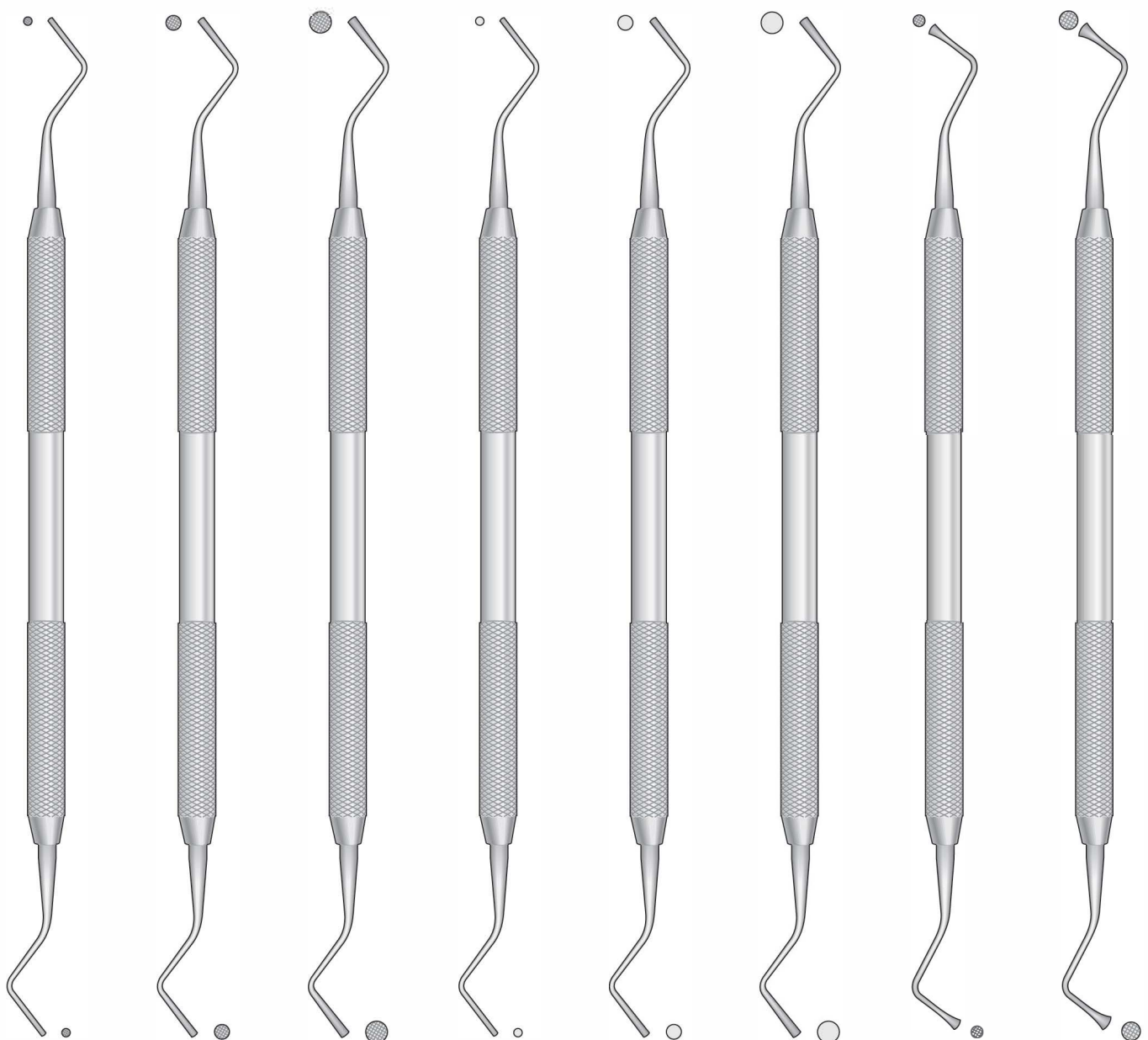

**SI-11478**  
Fig.1

**SI-11479**  
Fig.2

**SI-11480**  
Fig.3

**SI-11481**  
Fig.1L

**SI-11482**  
Fig.2L

**SI-11483**  
Fig.3L

**WARD**  
**SI-11484**

**WARD**  
**SI-11485**



Füllungsinstrumente  
Filling Instruments  
Strumenti per otturazione  
Instrumentos para obturación  
Instruments pour obturation

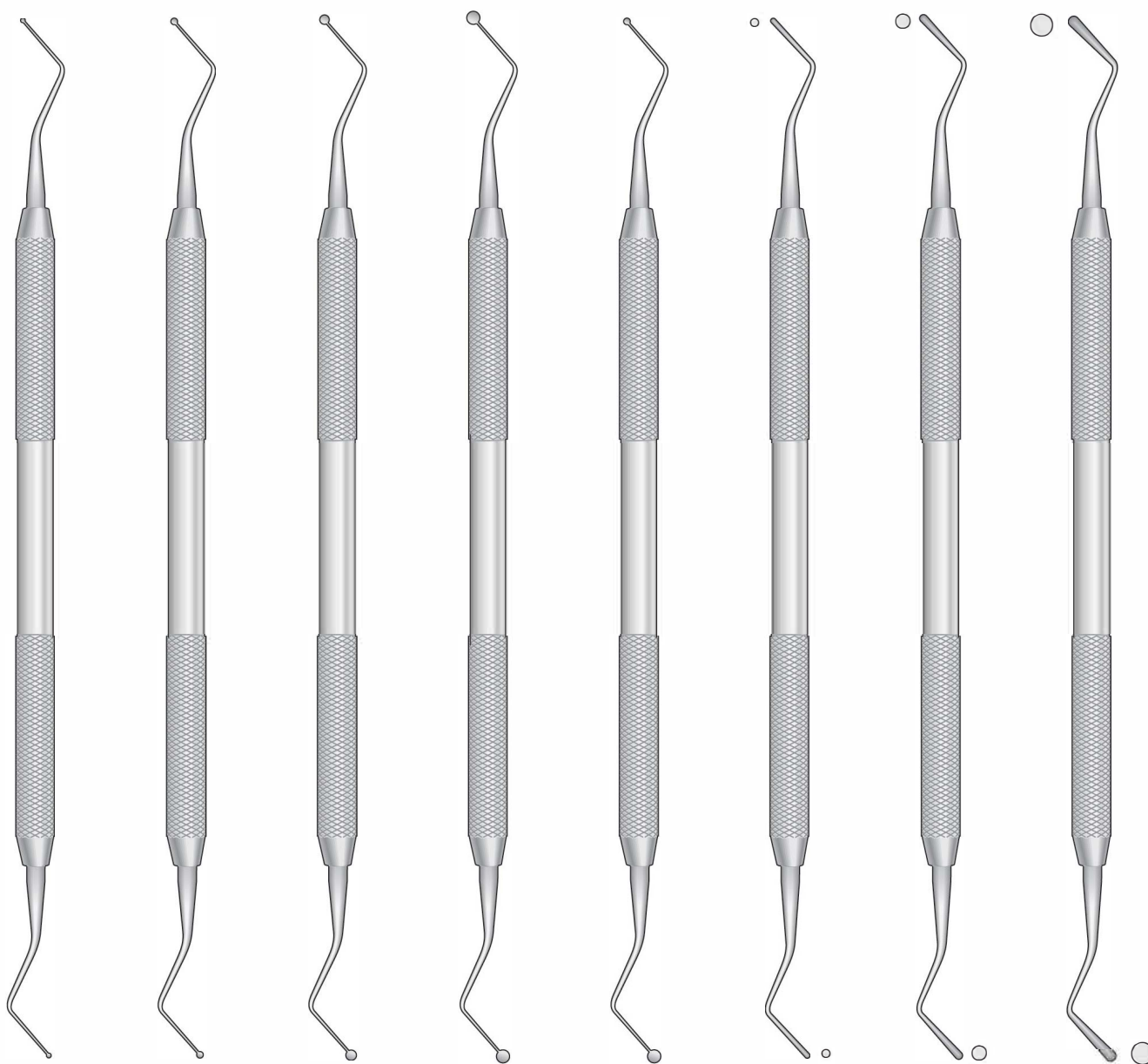

**SI-11486**  
Fig.1

**SI-11487**  
Fig.2

**SI-11488**  
Fig.3

**SI-11489**  
Fig.4

**SI-11490**  
Fig.5

**SI-11491**  
Fig.1

**SI-11492**  
Fig.2

**SI-11493**  
Fig.3



Füllungsinstrumente  
Filling Instruments  
Strumenti per otturazione  
Instrumentos para obturación  
Instruments pour obturation

**MARKLEY PLUGGERS**  
Amalgam Instrumente  
Amalgam Instruments  
Strumenti per amalgama  
Instrumentos para amalgama  
Instruments à amalgame



**SI-11494**  
Fig.1



**SI-11495**  
Fig.2

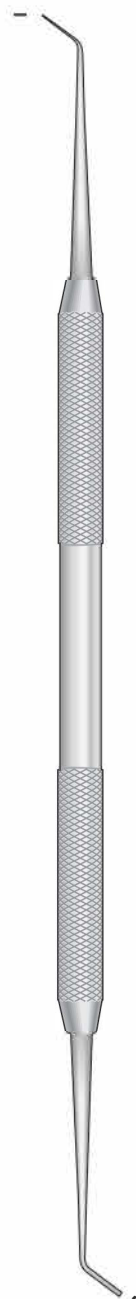

**SI-11496**  
Fig.3

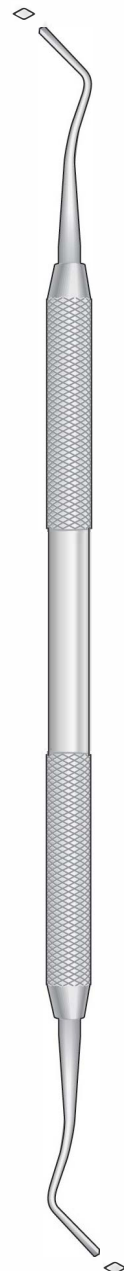

**SI-11497**  
Fig.4



**SI-11498**  
Fig.5



**SI-11499**  
Fig.6





Spaten - Füllungsinstrumente  
Spatulas - Filling Instruments  
Spatole - Strumenti per otturazione  
Espátulas - Instrumentos para obturación  
Spatules - Instruments pour obturation

Heidemann Spateln  
Heidemann Spatulas  
Spatole Heidemann  
Espátulas Heidemann  
Spatules Heidemann

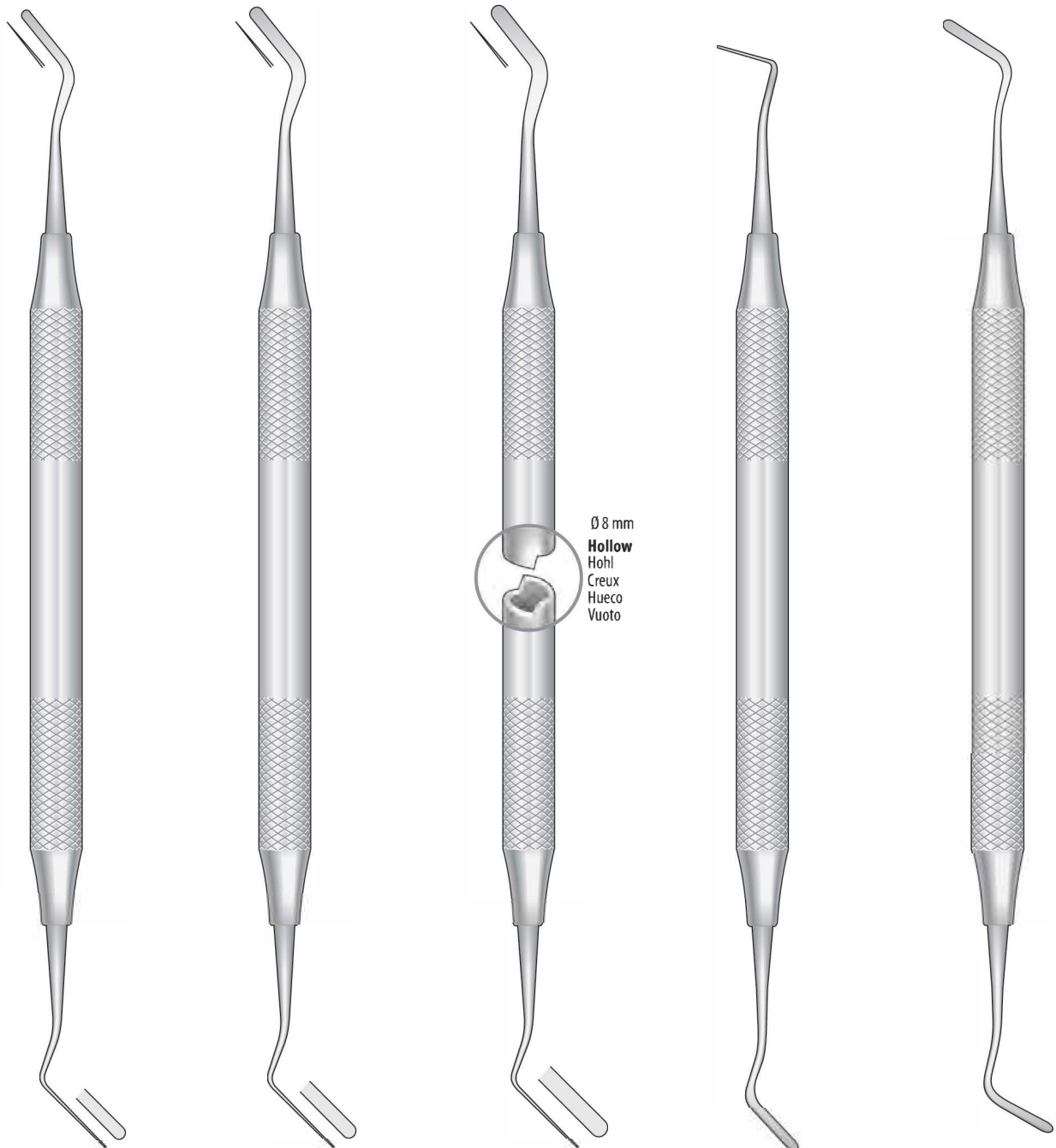

Ø 8 mm  
Hollow  
Hohl  
Creux  
Hueco  
Vuoto

HEIDEMANN  
**SI-11500**  
Fig.1

HEIDEMANN  
**SI-11501**  
Fig.2

HEIDEMANN  
**SI-11502**  
Fig.3

IPC Fig. 1  
**SI-11503**  
Interproximal

IPC/OA Fig. 2  
**SI-11504**  
Interproximal Off-Angle





Füllungsinstrumente  
Filling Instruments  
Strumenti per otturazione  
Instrumentos para obturación  
Instruments pour obturation

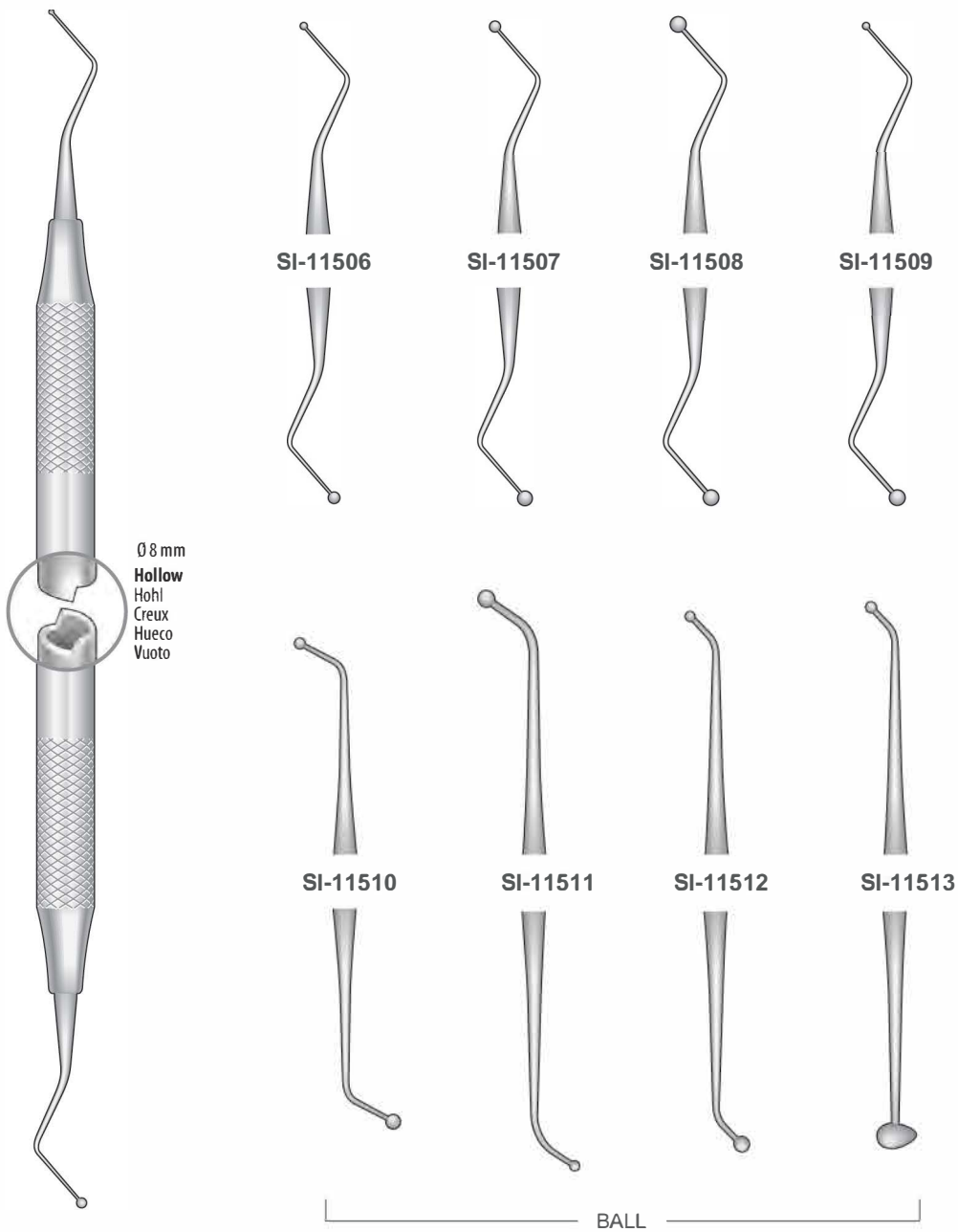

**SI-11505**



Füllungsinstrumente  
 Filling Instruments  
 Strumenti per otturazione  
 Instrumentos para obturación  
 Instruments pour obturation

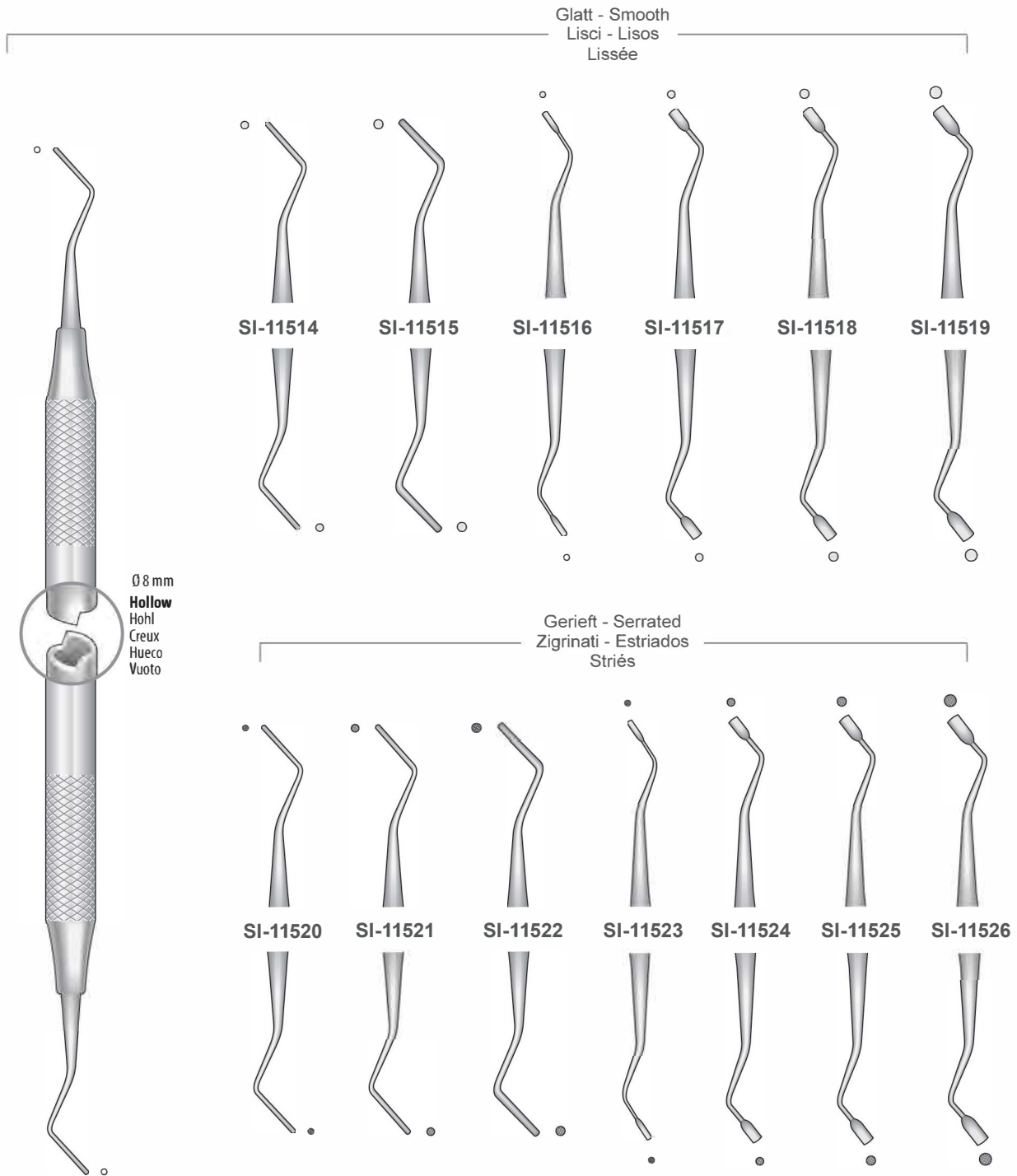

SI-11527



Füllungsinstrumente  
Filling Instruments  
Strumenti per otturazione  
Instrumentos para obturación  
Instruments pour obturation

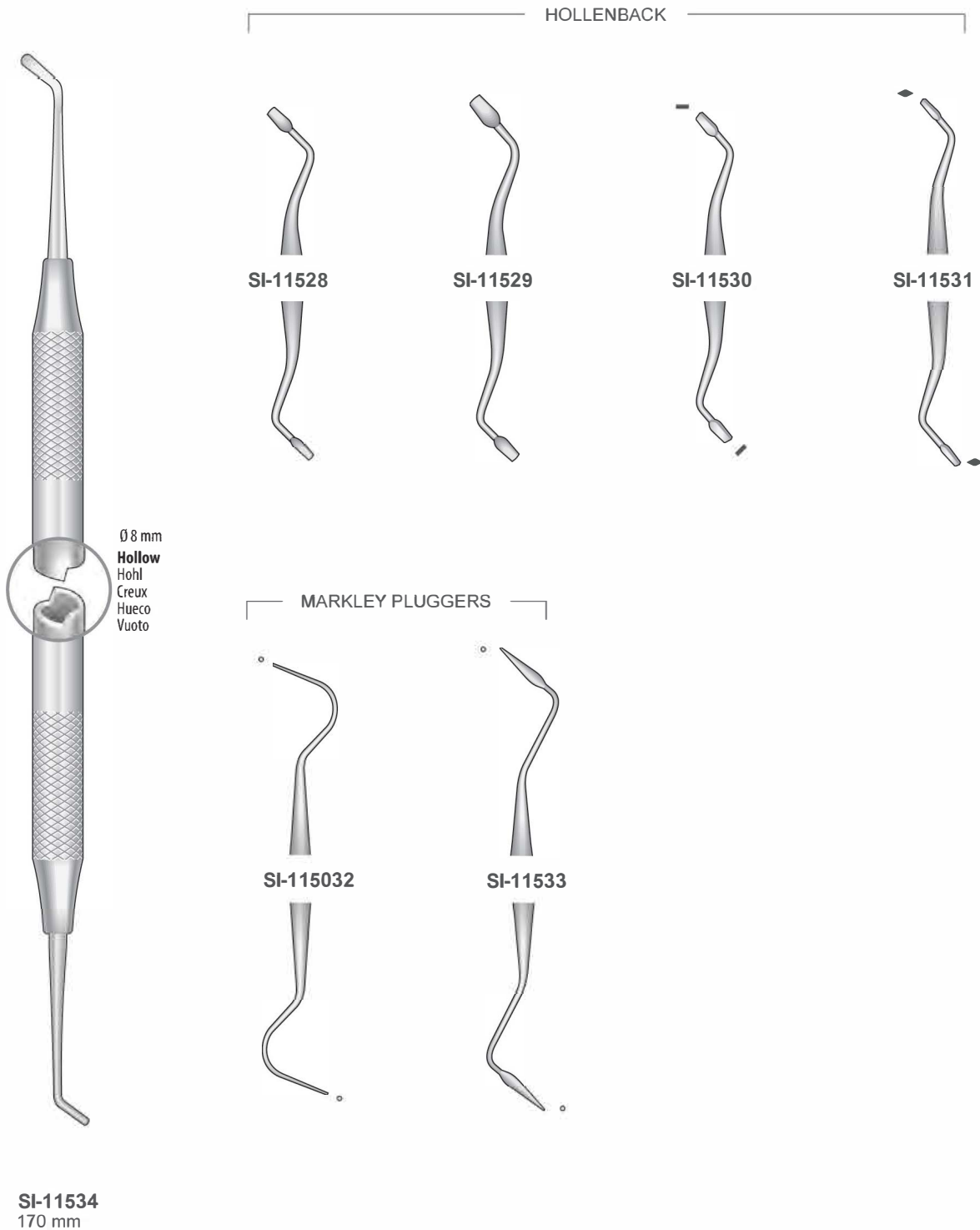



Füllungsinstrumente  
Filling Instruments  
Strumenti per otturazione  
Instrumentos para obturación  
Instruments pour obturation

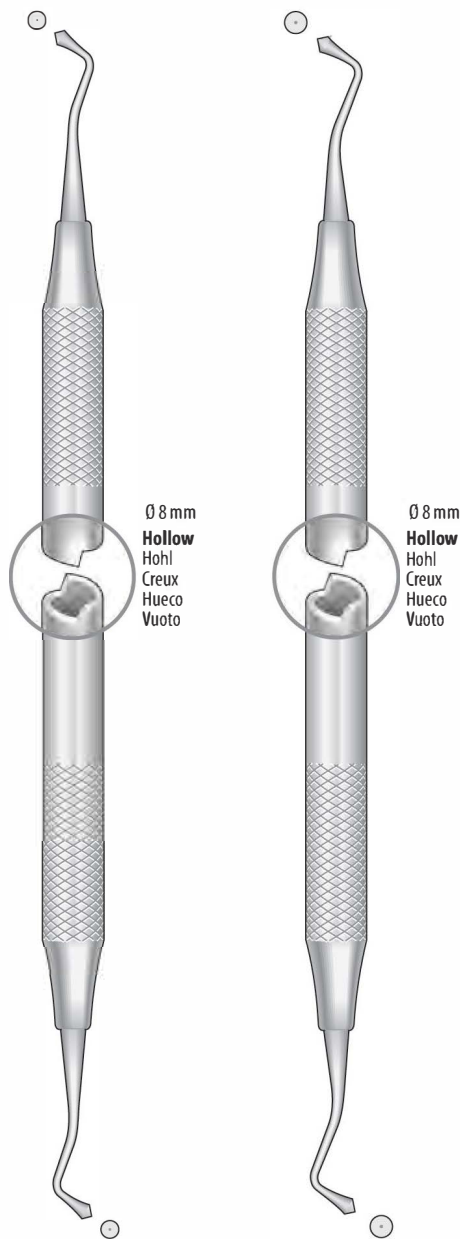

Ø 8 mm  
**Hollow**  
Hohl  
Creux  
Hueco  
Vuoto

Ø 8 mm  
**Hollow**  
Hohl  
Creux  
Hueco  
Vuoto

WESTCOTT  
SI-11543

WESTCOTT  
11544

WOODSON

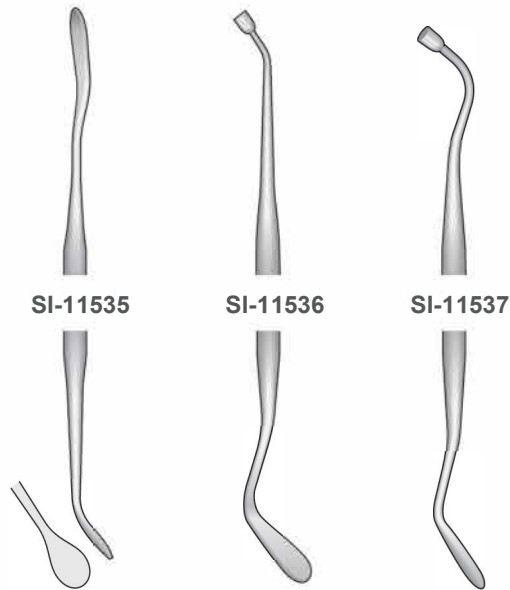

SI-11535

SI-11536

SI-11537

LADMORE

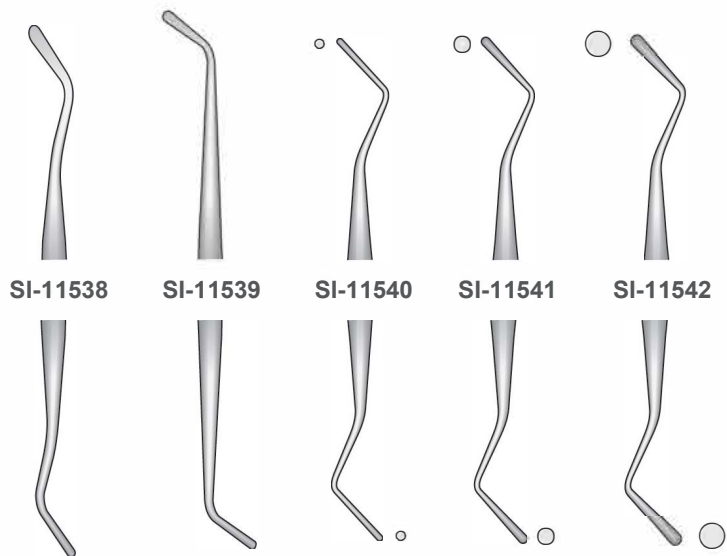

SI-11538

SI-11539

SI-11540

SI-11541

SI-11542



Füllungsinstrumente  
 Filling Instruments  
 Strumenti per otturazione  
 Instrumentos para obturación  
 Instruments pour obturation

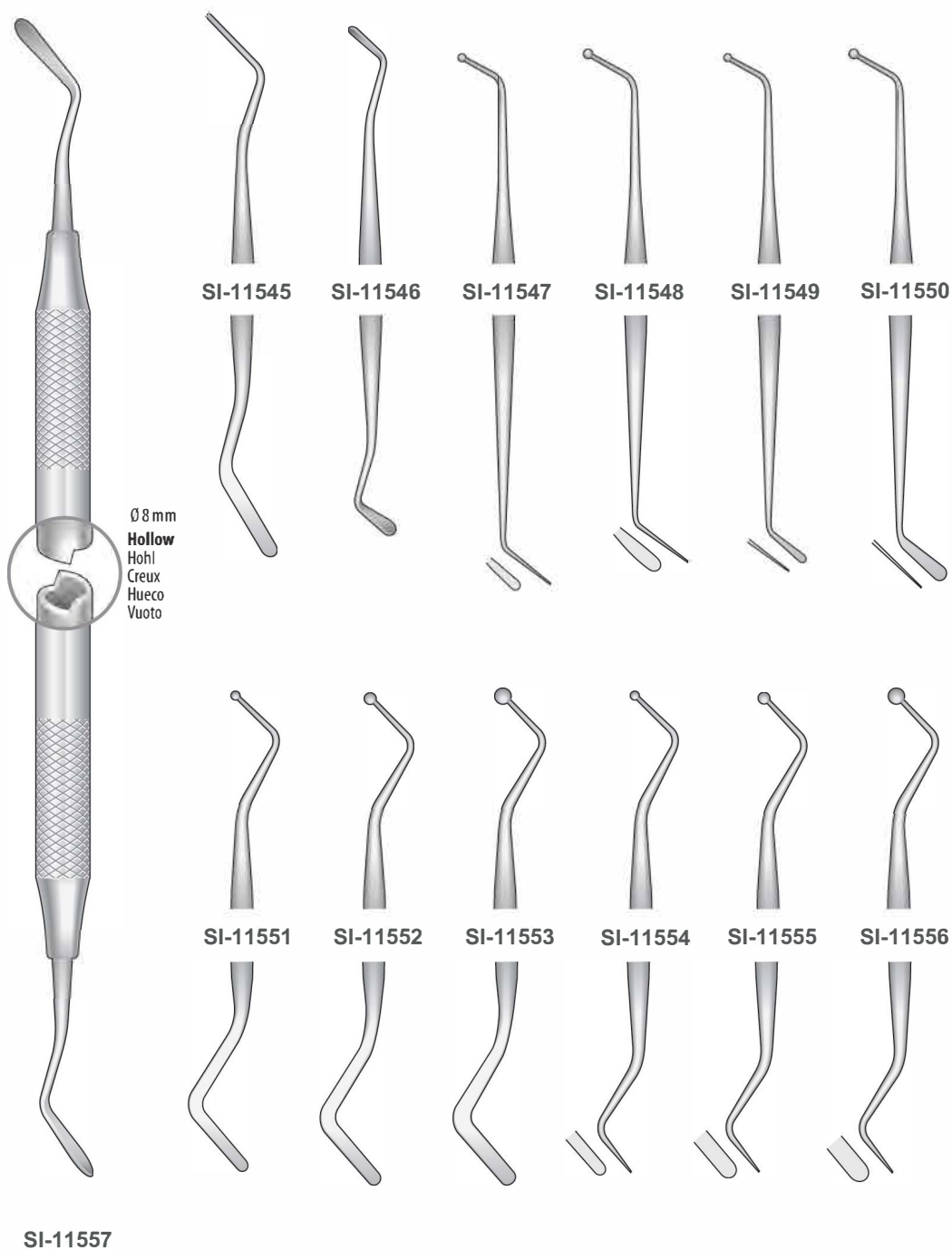



Kofferdam Instrumente  
Rubber-Dam Instruments  
Strumenti per diga  
Instrumentos para dique de goma  
Instruments pour digue de caoutchouc

Kofferdam-Klammern  
Rubber-Dam Clamps  
Uncini per diga  
Clamps para diques  
Crampons pour digue



IVORY  
**SI-11558**  
# 26



IVORY  
**SI-11559**  
# 27



IVORY  
**SI-11560**  
# 28



IVORY  
**SI-11561**  
# 29



IVORY  
**SI-11562**  
# 30



IVORY  
**SI-115623**  
# 31



IVORY  
**SI-11564**  
# 51



IVORY  
**SI-11565**  
# 60

Kofferdam-Rahmen  
Rubber-Dam Frames  
Telaio per diga  
Cuadro para diques  
Cadre à digue

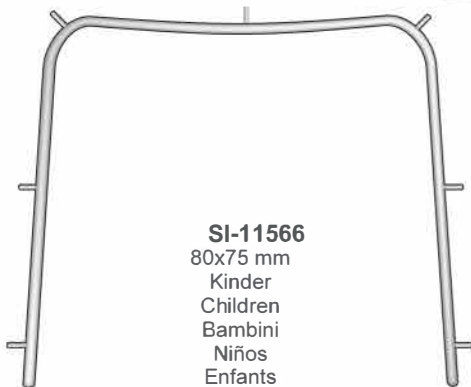

**SI-11566**  
80x75 mm  
Kinder  
Children  
Bambini  
Niños  
Enfants

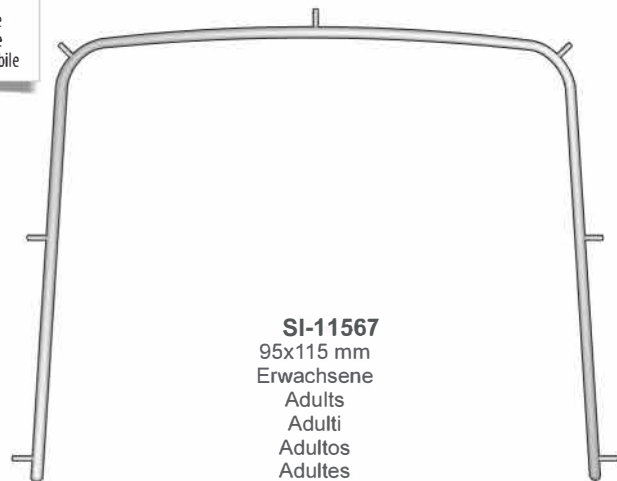

**SI-11567**  
95x115 mm  
Erwachsene  
Adults  
Adulti  
Adultos  
Adultes





Saugkanülen  
Suction Tubes  
Cannule per aspirazione  
Cánulas de aspiración  
Canules d'aspiration

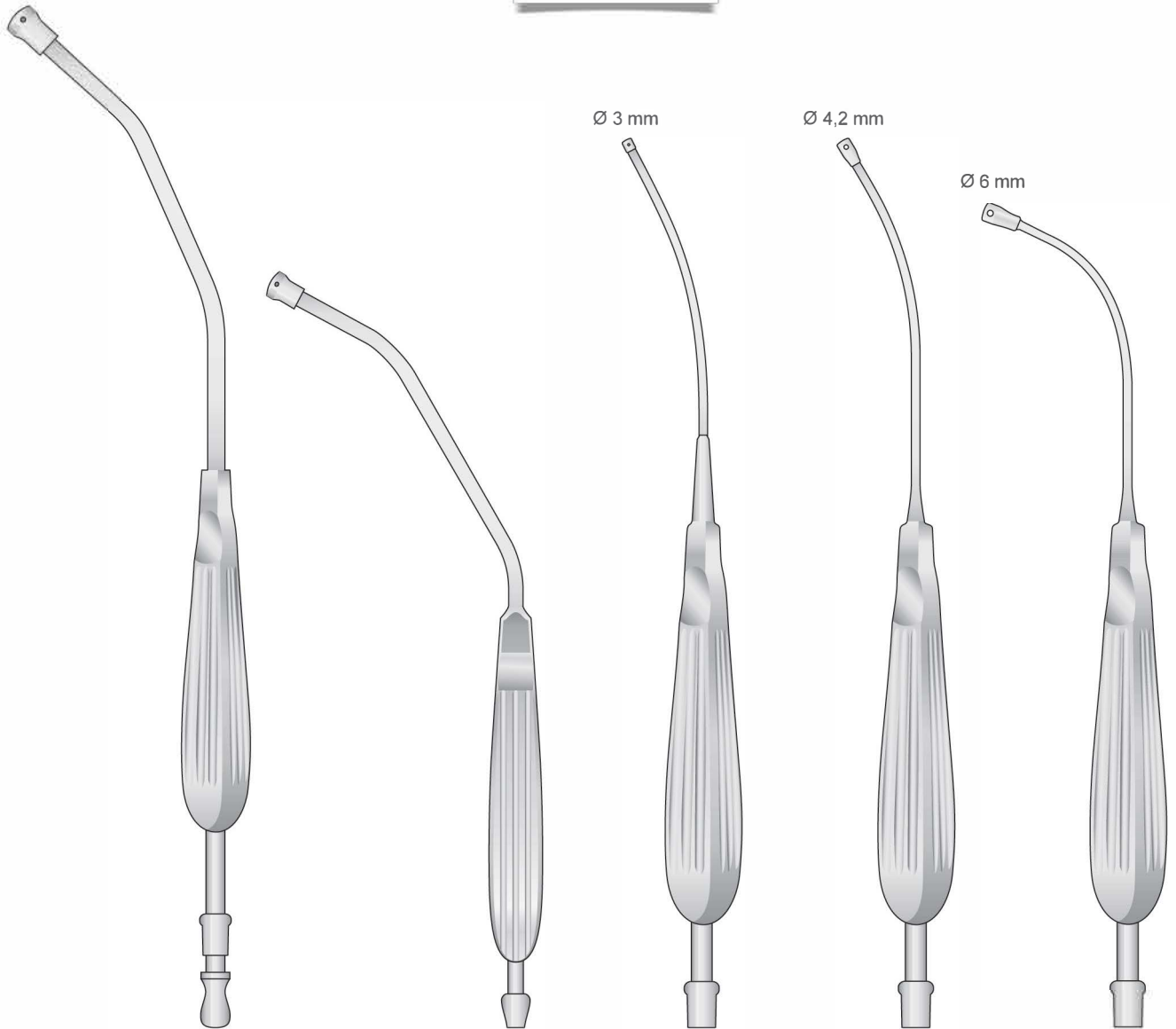

**YANKAUER**  
**SI-11568**  
310 mm

**BABY-YANKAUER**  
**SI-11569**  
200 mm

**ANDREWS-PYNCHON**  
**SI-11570**  
250 mm

**ANDREWS-PYNCHON**  
**SI-11571**  
250 mm

**ANDREWS-PYNCHON**  
**SI-11572**  
230 mm



Saugkanülen  
Suction Tubes  
Cannule per aspirazione  
Cánulas de aspiración  
Canules d'aspiration

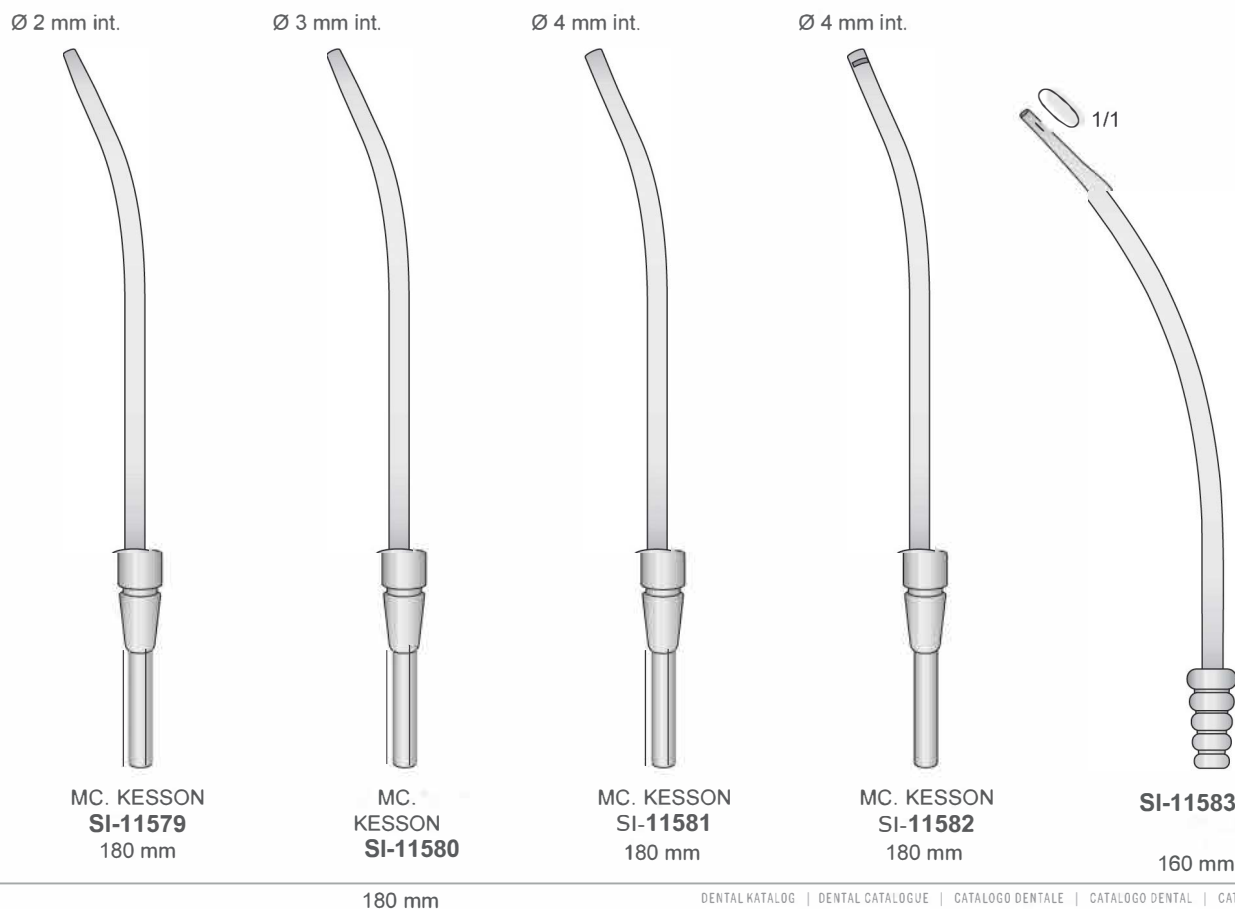
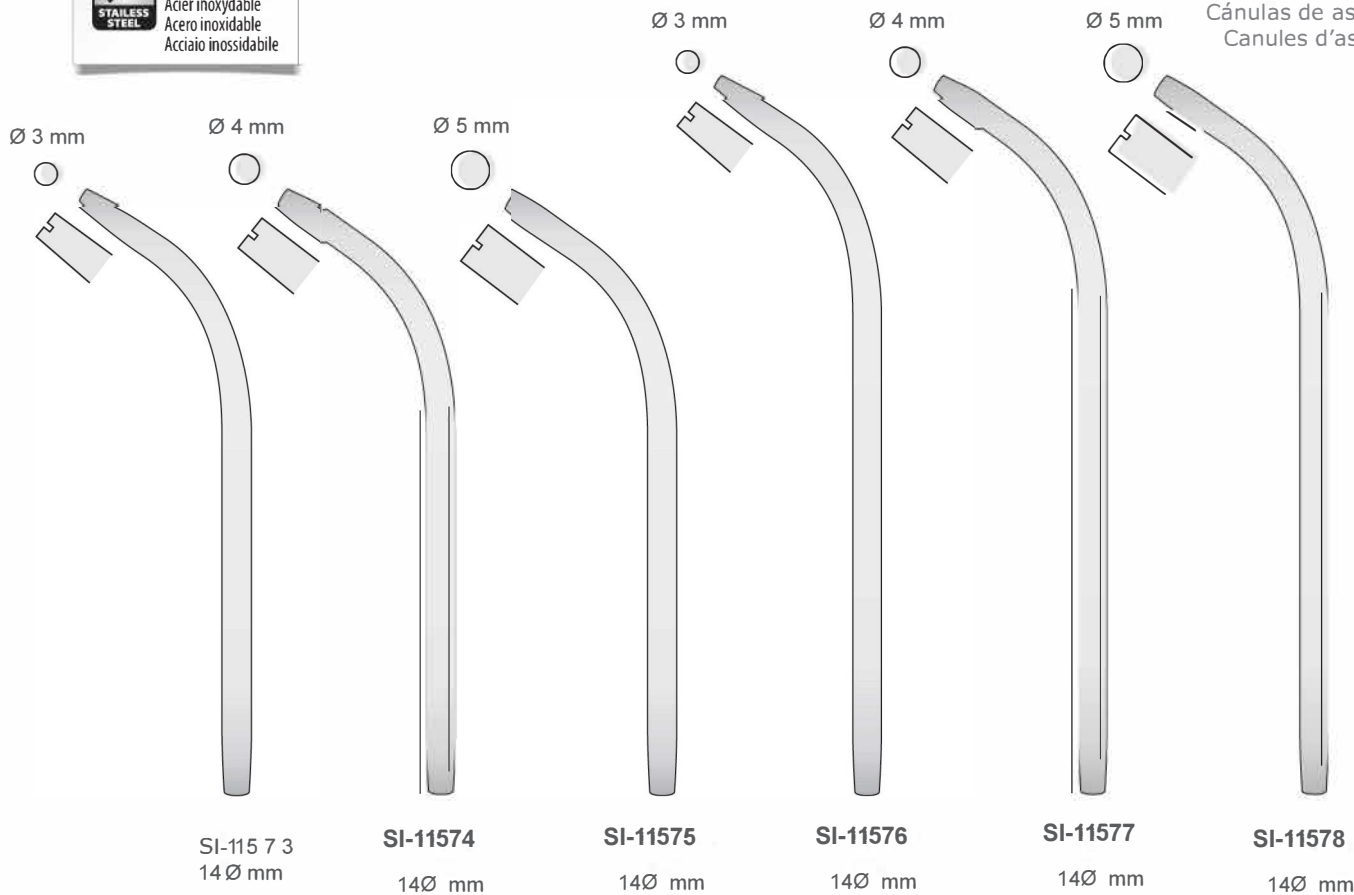



Saugkanülen  
Suction Tubes  
Cannule per aspirazione  
Cánulas de aspiración  
Canules d'aspiration

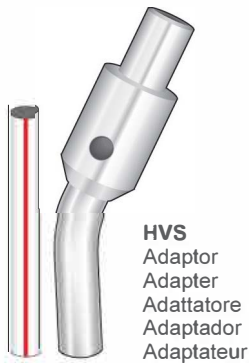

**SI-11589**  
Connection piece for suction  
75 mm - 100% Stainless Steel

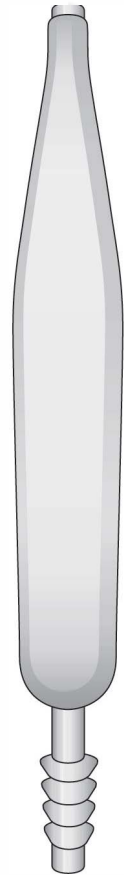

**COUPLAND**  
**SI-11588**  
150 mm

Ø 1 mm      Ø 1,5 mm      Ø 2,5 mm      Ø 3,5 mm int.

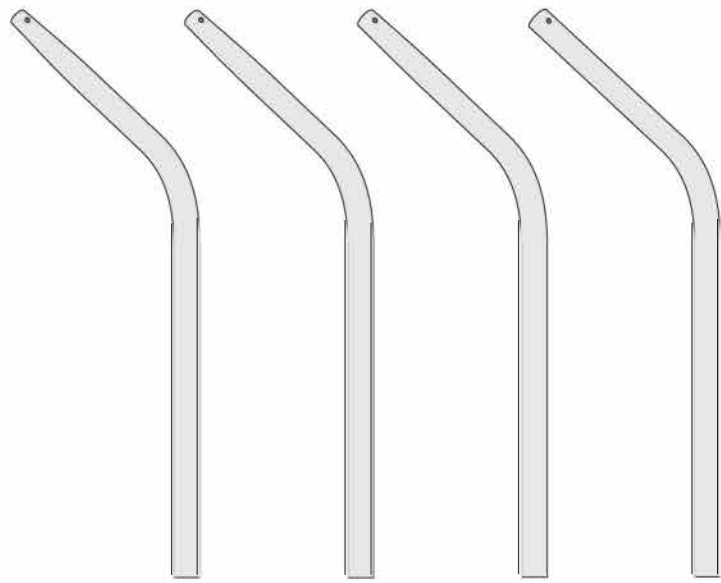

**SI-11584** 95 mm      **SI-11585** 95 mm      **SI-11586** 95 mm      **SI-11587** 95 mm

**COMPLETE SET**  
**11593**  
(GF-01 + GF-02 + GF-03 + GF-04 + GF-05)  
Griff + 4 Kanülen  
Handle + 4 tubes  
Manico + 4 cannule  
Mango + 4 cánulas  
Manche + 4 canules



**GF-271**  
56 mm  
Adaptor  
Adapter  
Adattatore  
Adaptador  
Adaptateur  
Ø Ext. 6,0 mm  
Ø Int. 4,5 mm

**Autoclavable Tubing**  
Schlauch - Silikon  
Flexible Tube - Silicone  
Raccordo in silicone per cannule  
Tubo flexible de silicona  
Tuyau - Silicone



**SI-11592**  
2 m



**SI-11590**  
B1 Byrd  
Self-Cleaning  
Aspirator

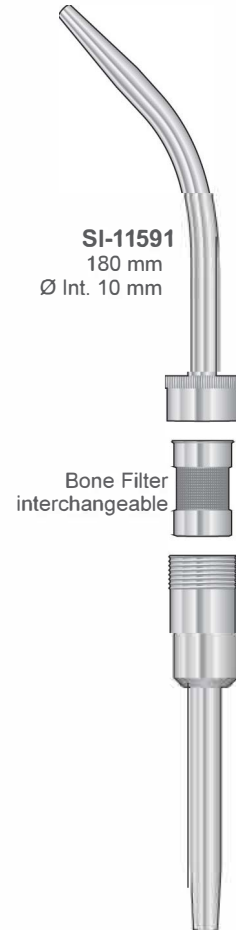

**SI-11591**  
180 mm  
Ø Int. 10 mm  
Bone Filter  
interchangeable



Saugkanülen  
Suction Tubes  
Cannule per aspirazione  
Cánulas de aspiración  
Canules d'aspiration

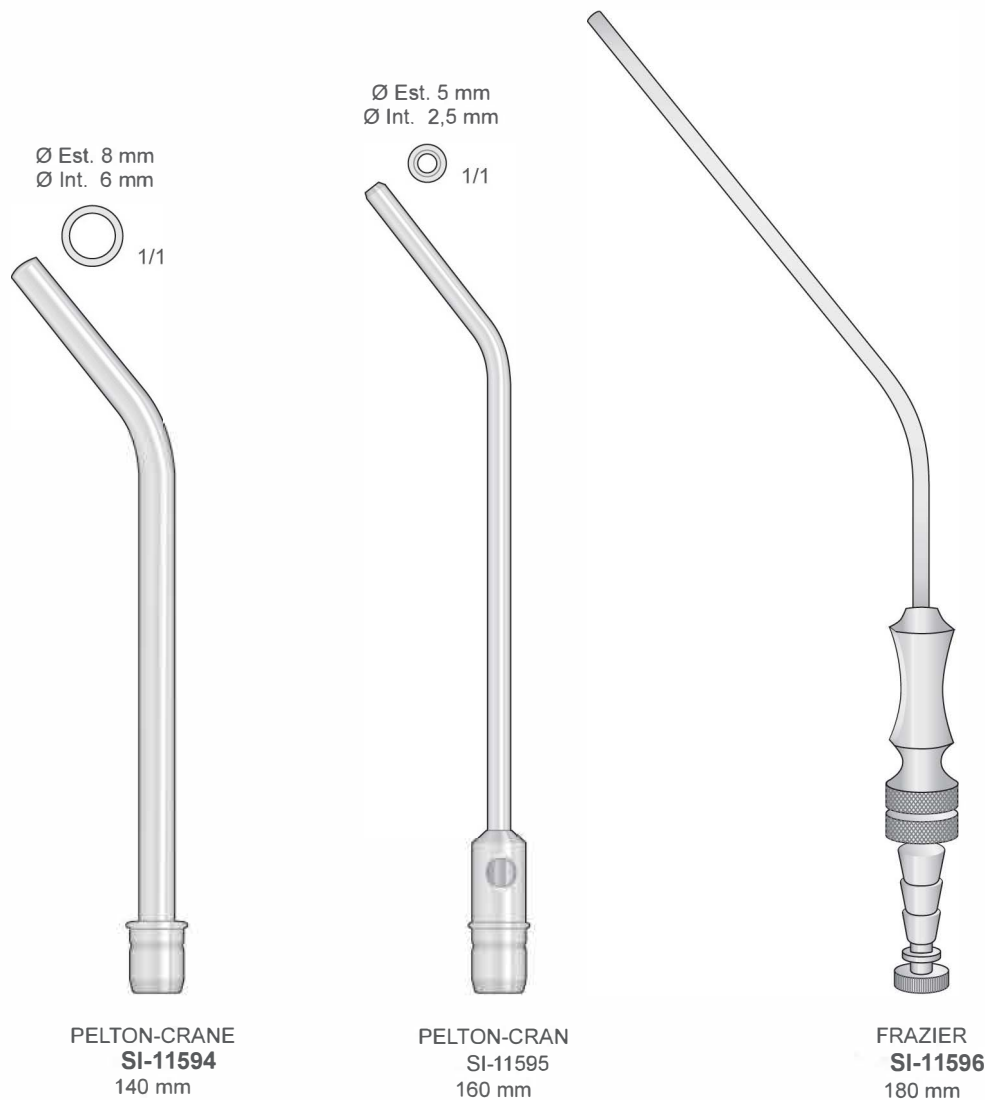



Saugkanülen  
Suction Tubes  
Cannule per aspirazione  
Cánulas de aspiración  
Canules d'aspiration



Flexible  
Flexibel  
Flexible  
Flexible  
Flessibile

Ø 3 mm

**WERTHEIMER**  
**SI-11597**  
160 mm



**FRAZIER**  
**SI-11598**  
160 mm

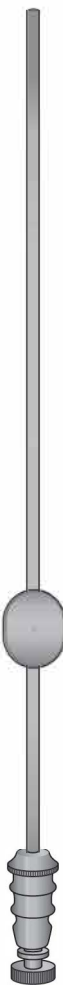

Flexible  
Flexibel  
Flexible  
Flexible  
Flessibile

Ø 3 mm

**FRAZIER**  
**SI-11599**  
200 mm

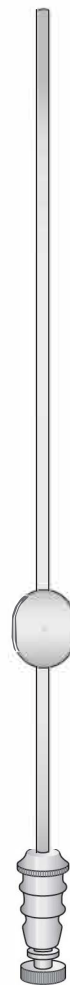

**WERTHEIMER**  
**SI-11600**  
200 mm

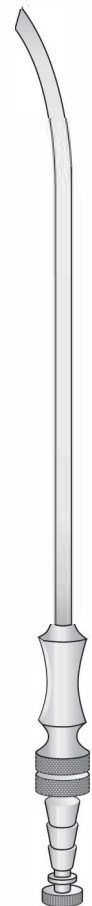

**ADSON**  
**SI-11601** ch. 12 Ø 4 mm  
**SI-11602** ch. 15 Ø 5 mm 210 mm



Kanülenreinigungs-Bürsten  
Cleaning brush for Tubes  
Scovolini per pulizia cannule  
Cepillo para limpiar cánulas  
Brosse de nettoyage pour canules



Bürsten  
Brush  
Spazzola  
Cepillo  
Brosse

Autoklav  
Autoclavable  
Autoclavabile  
Autoclave  
Autoclave

**SI-11603**  
4 x 11 cm

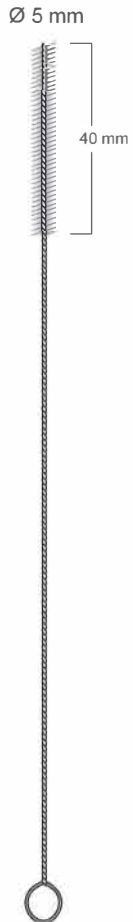

**SI-11604**  
235 mm



**SI-11605**  
215 mm



**SI-11606**  
300 mm

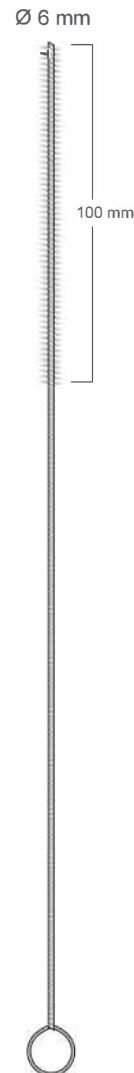

**SI-11607**  
300 mm

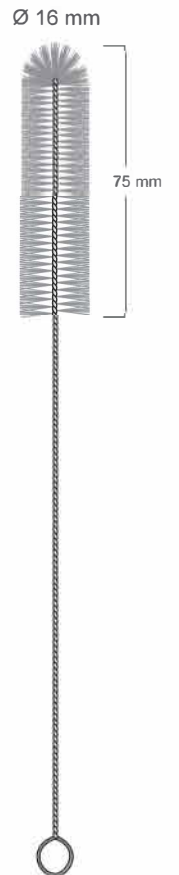

**SI-11608**  
220 mm





Instrumente für Laboratorium  
Instruments for laboratory  
Strumenti da laboratorio  
Instrumentos para laboratorio  
Instruments pour laboratoire



P.K. THOMAS  
**SI-11609**  
165 mm

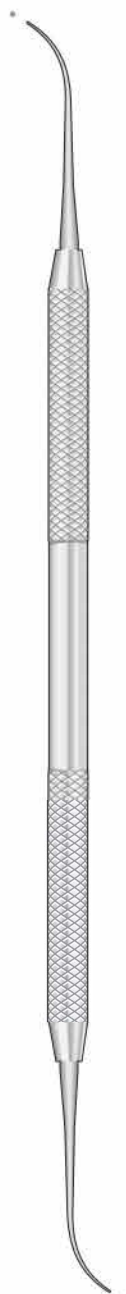

P.K. THOMAS  
**SI-11610**  
165 mm



P.K. THOMAS  
**SI-11611**  
165 mm

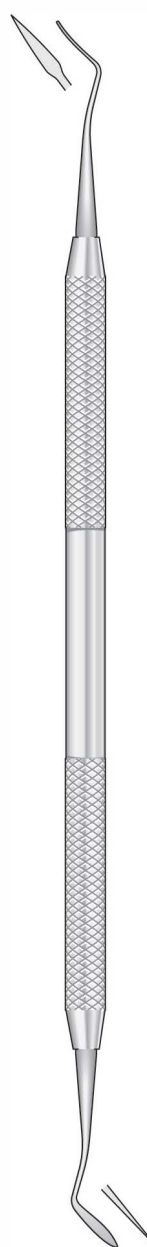

P.K. THOMAS  
**SI-11612**  
165 mm

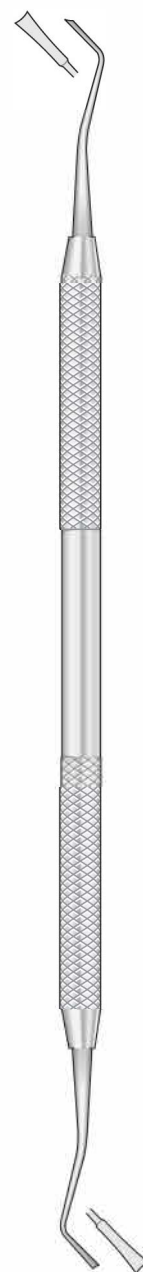

P.K. THOMAS  
**SI-11613**  
165 mm



Instrumente für Laboratorium  
Instruments for laboratory  
Strumenti da laboratorio  
Instrumentos para laboratorio  
Instruments pour laboratoire

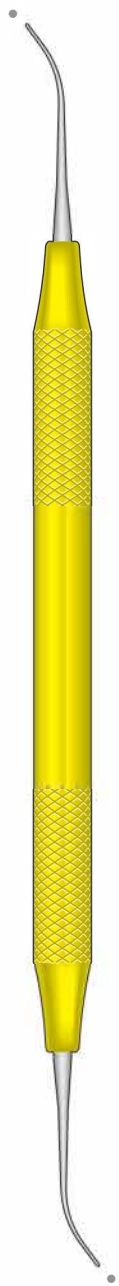

P.K. THOMAS  
**SI-11614**  
165 mm

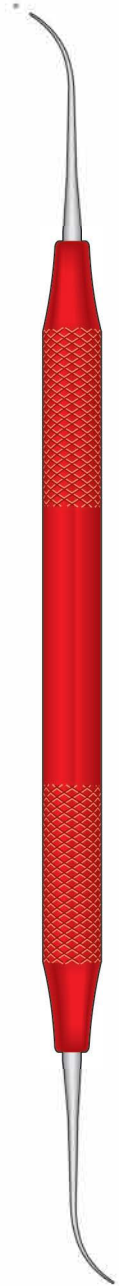

P.K. THOMAS  
**SI-11615**  
165 mm

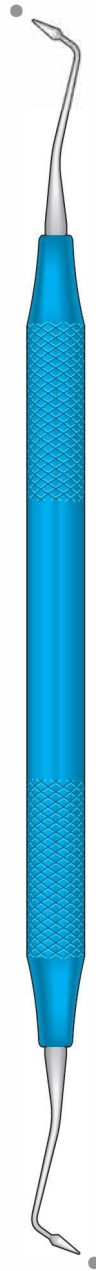

P.K. THOMAS  
**SI-11616**  
165 mm

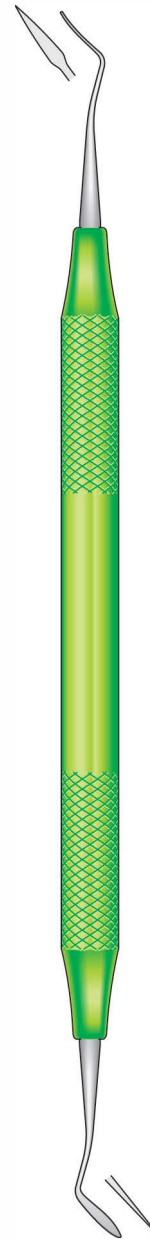

P.K. THOMAS  
**SI-11617**  
165 mm



Ø 8 mm  
**Hollow**  
Hohl  
Creux  
Hueco  
Vuoto

P.K. THOMAS  
**SI-11618**  
165 mm



Modellierinstrumente für Keramik  
Ceramic Sculpturing Instruments  
Strumenti per ceramica  
Instrumentos para modelar la cerámica  
Instruments à modeler la céramique

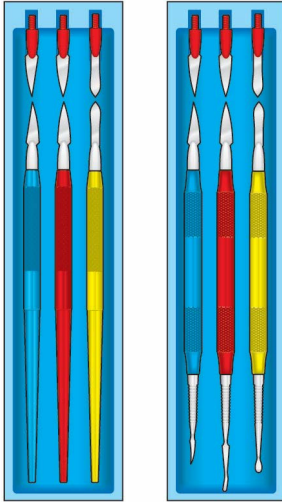

Biegsam - Flexible  
Flessibili - Flexibles  
Flexibles

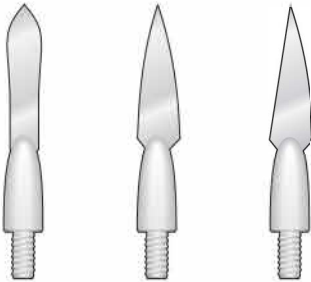

SI-11619    SI-11620    SI-11621

Superbiegsam - Superflexible  
Superflessibili - Superflexibles  
Superflexibles

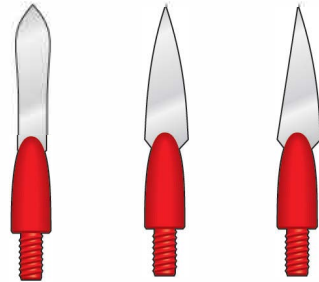

SI-11622    SI-11623    SI-11624



SI-11624A



SI-11624B

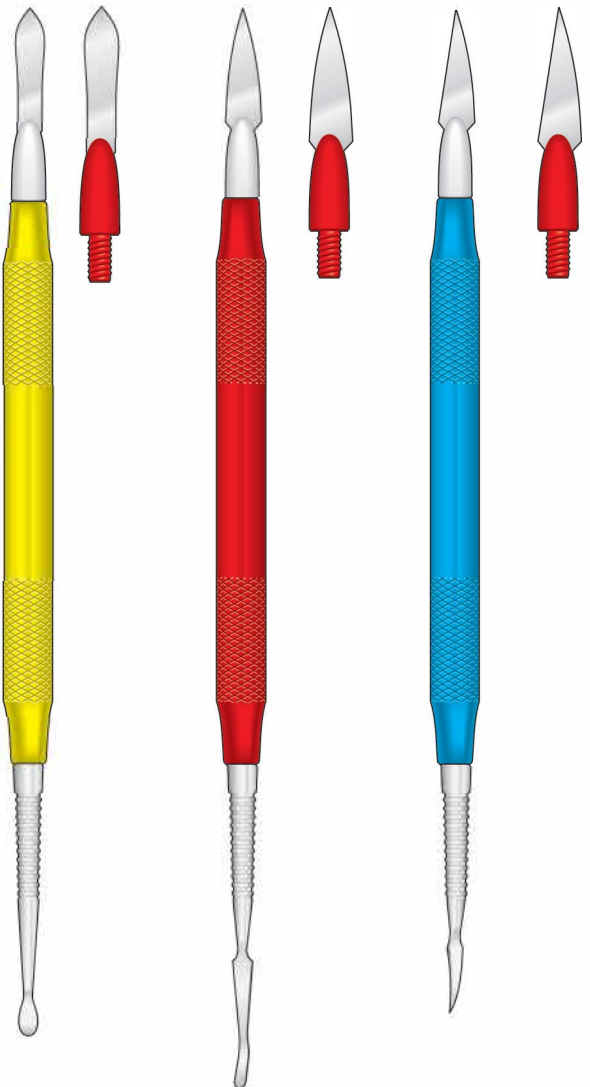



Instrumente für Laboratorium  
Instruments for laboratory  
Strumenti da laboratorio  
Instrumentos para laboratorio  
Instruments pour laboratoire

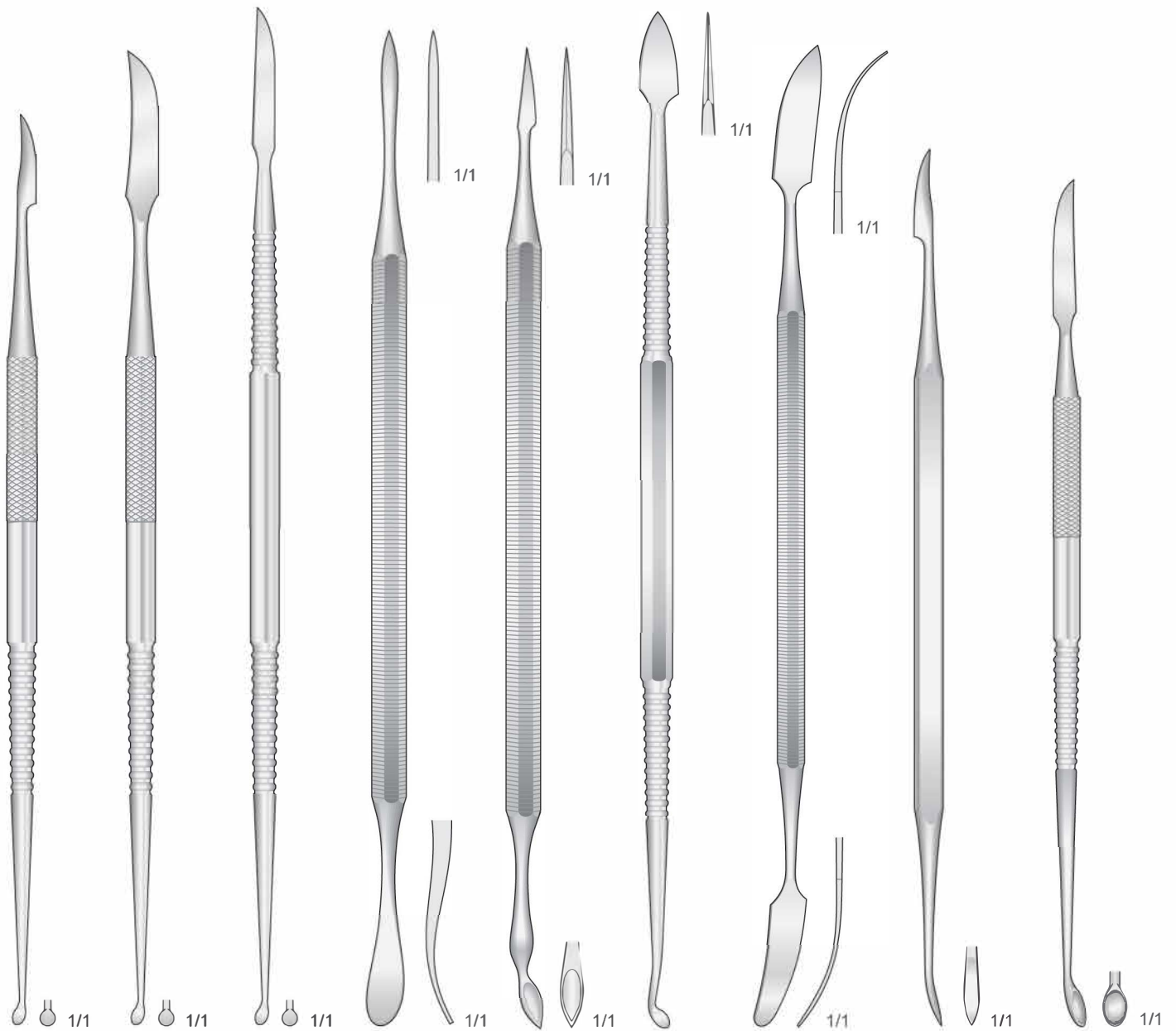

LE CRON  
SI-11625

LE CRON  
SI-11626

LE CRON  
SI-11627

BEALE  
SI-11628

ROACH  
SI-11629

VEHE  
SI-11630

GRITMANN  
SI-11631

HYLIN  
SI-11632

HYLIN  
SI-11633



Instrumente für Laboratorium  
Instruments for laboratory  
Strumenti da laboratorio  
Instrumentos para laboratorio  
Instruments pour laboratoire

Gipsschneidezange  
Plaster cutting pliers  
Cesoia taglia gesso  
Alicates para cortar yeso  
Pince à couper le piâtre

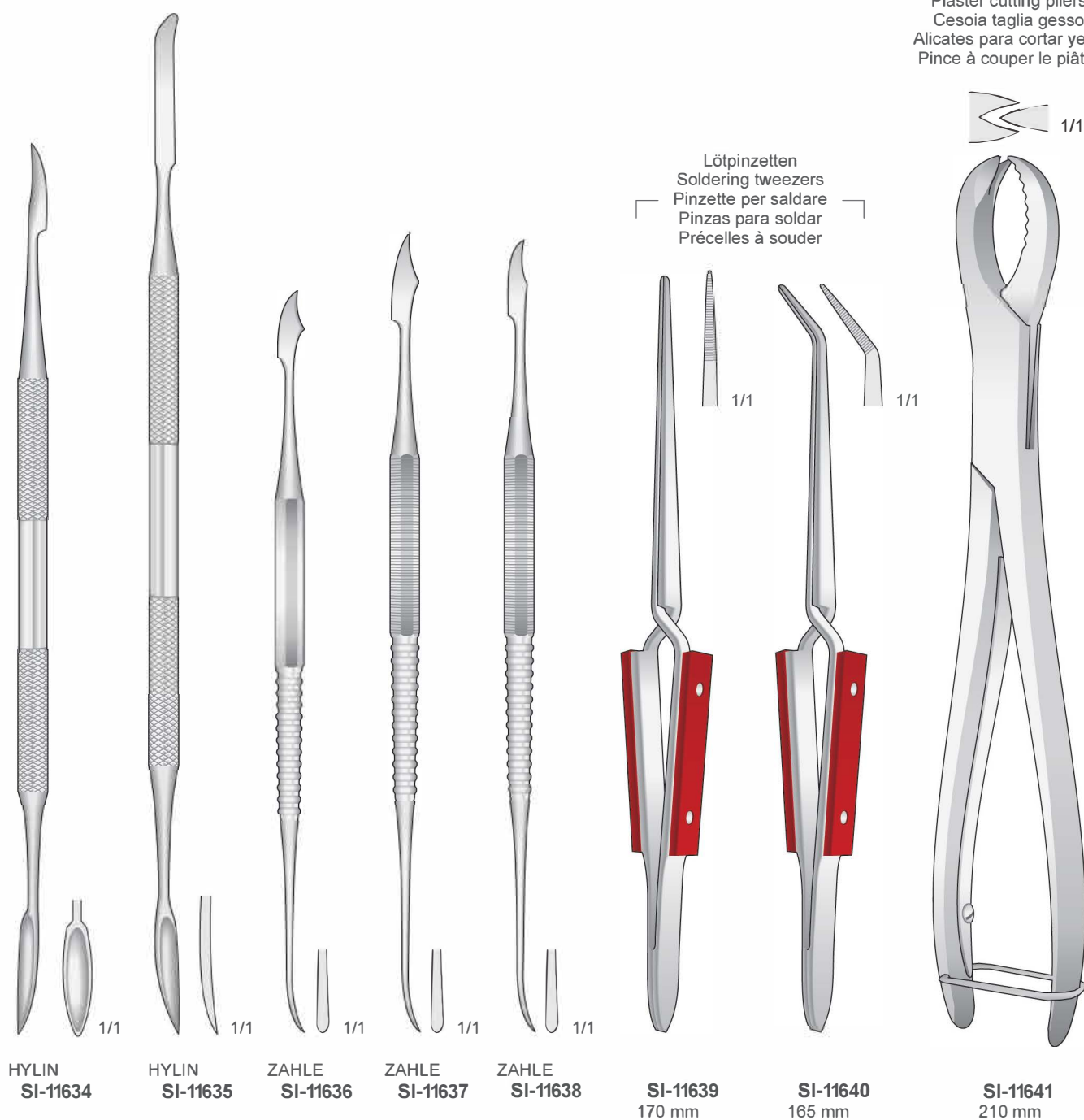





**Si Surgica**  
Instruments



Inquiry now Today!  
**+92-52-4598741**  
**+92-305-4278741**  
**+92-320-6330772**

[info@surgica-intl.com](mailto:info@surgica-intl.com)

**Muhammad pura Paris Road**  
**Sialkot 51310. Pakistan**

[www.surgica-intl.com](http://www.surgica-intl.com)